

Demetra wall 3000K anthracite grey

SPECIFICATIONS

DEM1101



Design By

Naoto Fukasawa

Collection

Design



Specifications

Delivered lumens	392lm
Light output ratio	43.56lm/W
Power consumption	9W
Led type	8.5W Array*
CCT (Correlated Color Temperature)	3000K
CRI (Color Rendering Index)	>80
Life expectancy	50000Hrs
Control type	DIMMABLE (On Head) / No Motion Sensor
Input Voltage	120-240V
Driver	Plug-In

Colors & Finishes

Anthracite grey

Materials

- Head and arms in painted aluminum
- Lower head diffuser in thermoplastic
- Internal tension springs and external tension control cables in aluminum
- Wall support in painted aluminum

Features & Accessories

- Fully adjustable arms and head
- Tilttable and rotatable diffuser
- Interchangeable plug options accommodate most electrical outlets for global versatility

Dimensions

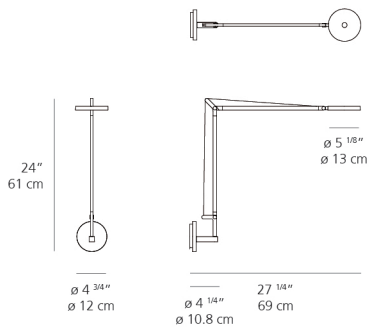

Packaging

2 Boxes

1 x 42" x 14" x 2-5/8" / 5.51 lbs - 106.5 cm x 35.5 cm x 6.5 cm / 2.5 kg

1 x 7-15/16" x 7-15/16" x 6-3/8" / .77 lbs - 20 cm x 20 cm x 16 cm / .35 kg

Light distribution

Direct

Luminaire weight

1.87 lbs / .85 kg

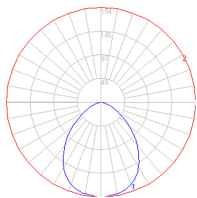

Warranty

5 year limited warranty

Red = Max Cd. Through Vertical plane

Blue = Max Cd. Through Horizontal plane