

LED Vanity Lamp

EW6818

INSTALLATION SHEET

START FROM HERE

- Make sure power is completely off at the fuse box.
- Have your fixture installed by a qualified licensed electrician
- Prepare everything in a clear area.
- Wear gloves at all times during this installation.
- Read instructions carefully before you start assembly.
- Keep this instruction sheet for future reference.

Technical Support: 1-877-452-6858

Please Note:

- All Kuzco LED fixtures come with pre-wired LED module(s).
- Unless instructed to do so, please do not touch any part of the LED module(s) as any unnecessary contact with the module could cause permanent damage.
- For dimming, an ELV (Electronic Low Voltage) type of dimmer is required.

- 1.** Remove the fixture from its original packaging. Remove the mounting plate **(1c)** from within the canopy **(2b)** by removing the four screws **(2a)**. Pull out the mounting plate **(1c)** from within the canopy **(2b)** and attach it to the electrical junction box **(1a)**, using the two screws **(1d)** provided in the hardware package.
- 2.** Attach all wiring with the provided marrets **(1b)** (white to white "N", black to black "L", ground to ground "G"). Align the canopy **(2b)** to the back plate and screw in the four screws **(2a)** provided to secure the canopy **(2b)** to the back plate **(1c)**.
- 3.** You have now completed the installation of your fixture, do enjoy.

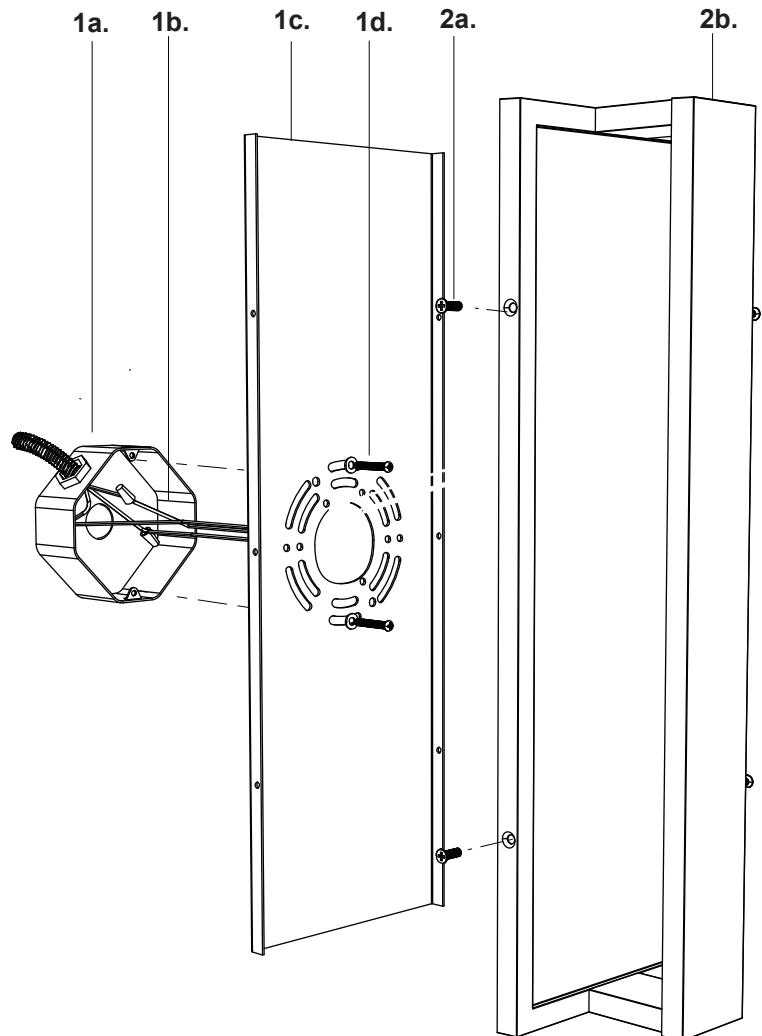

KUZCO LIGHTING

19054 28th Avenue Surrey, BC Canada V3S 6M3
T: 604 538 7162 TF: 1-855 85 KUZCO F: 604 538 7196
W: kuzcolighting.com
20170116