

Ceiling LED Pendant

FM7916
INSTALLATION SHEET

START FROM HERE

- Make sure power is completely off at the fuse box.
- Have your fixture installed by a qualified licensed electrician
- Prepare everything in a clear area.
- Wear gloves at all times during this installation.
- Read instructions carefully before you start assembly.
- Keep this instruction sheet for future reference.

Technical Support: 1-877-452-6858

Please Note:

- All Kuzco LED fixtures come with pre-wired LED module(s).
- Unless instructed to do so, please do not touch any part of the LED module(s) as any unnecessary contact with the module could cause permanent damage.
- For dimming, an ELV (Electronic Low Voltage) type of dimmer is required.

- 1.** Remove the fixture from its original packaging and remove the mounting plate (1c) from within the hardware package. Attach the mounting plate (1c) to the electrical junction box (1a) on the ceiling using the two screws (1e) provided in the hardware package.
- 2.** Attach the fixture to the mounting plate, to the electrical junction box on the ceiling. First attach all wiring (2b) with the provided marrets (white to white "N", black to black "L", ground to ground "G"). Align the mounting plate screws (1d) through the holes on the back of the fixture (1a) and in a clockwise direction thread nuts (2c) to the electrical junction box until the fixture is secured to the ceiling.
- 3.** Install the shade cover (2d) by placing it onto the metal pan on the underside of the fixture and turn clockwise until secure. (*do not over tighten*).
- 4.** You have now completed the installation of your fixture, enjoy.

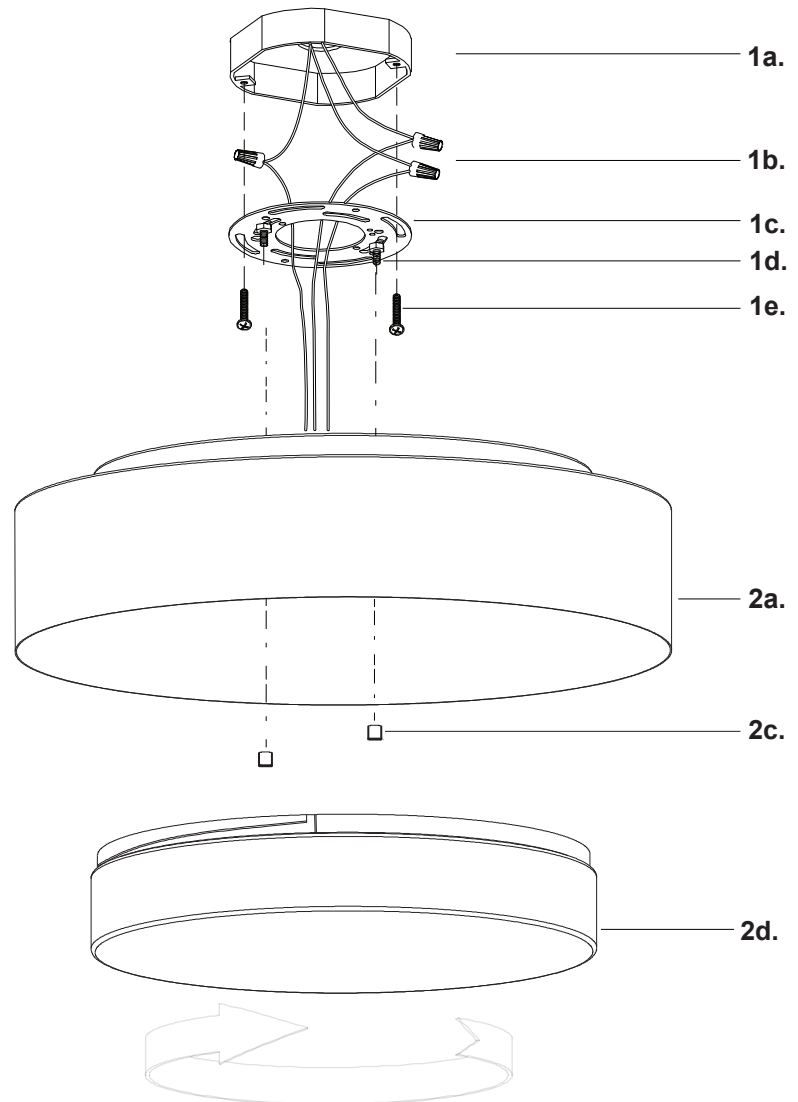

KUZCO
LIGHTING

19054 28th Avenue Surrey, BC Canada V3S 6M3
T: 604 538 7162 TF: 1-855 85 KUZCO F: 604 538 7196
W: kuzcolighting.com
20151217