

# DOMENICA

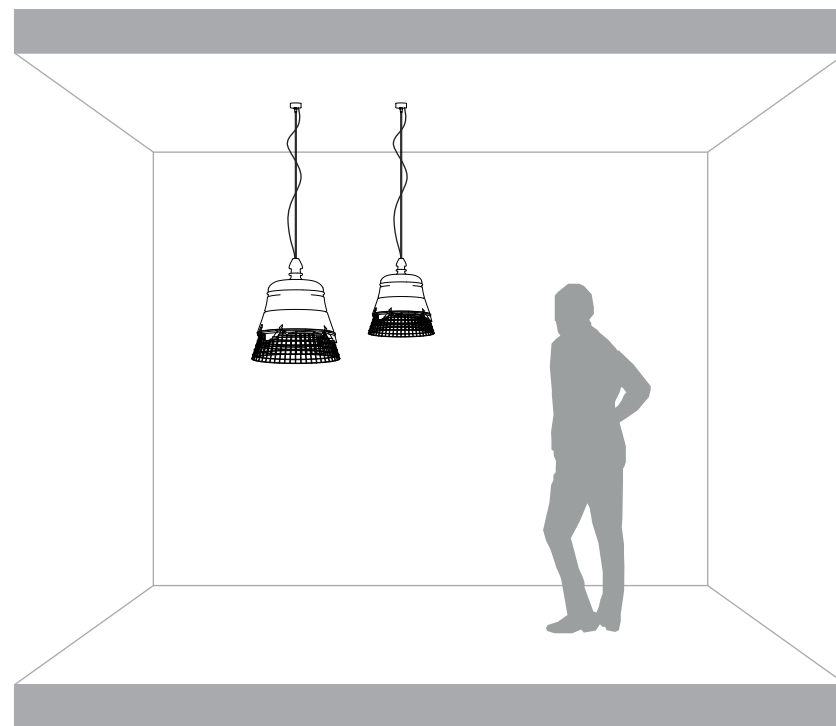

SE102 1B INT  
SE102 1O INT  
SE102 2B INT  
SE102 2O INT

220-240 V.  
max 1x70W - E27



Karman srl

Via A. Grandi, San Martino del piano, 61034 Fossombrone (PU), Italy - p.iva 02175640412 tel +39 0721 71 5042 r.a fax +39 0721 716640 - [www.karmanitalia.it](http://www.karmanitalia.it)



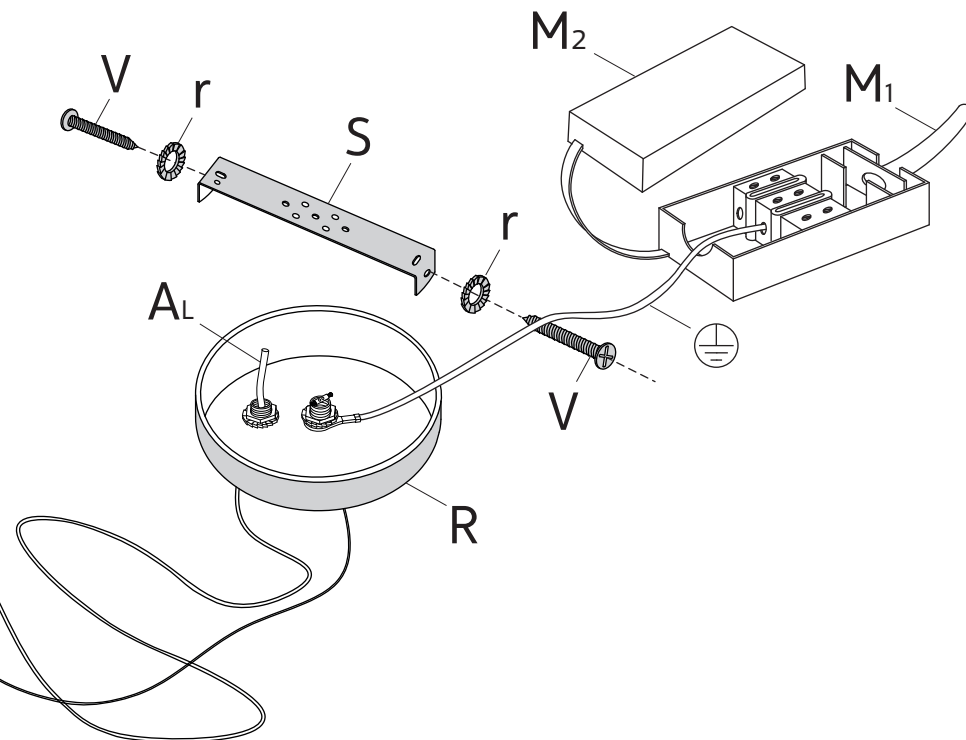
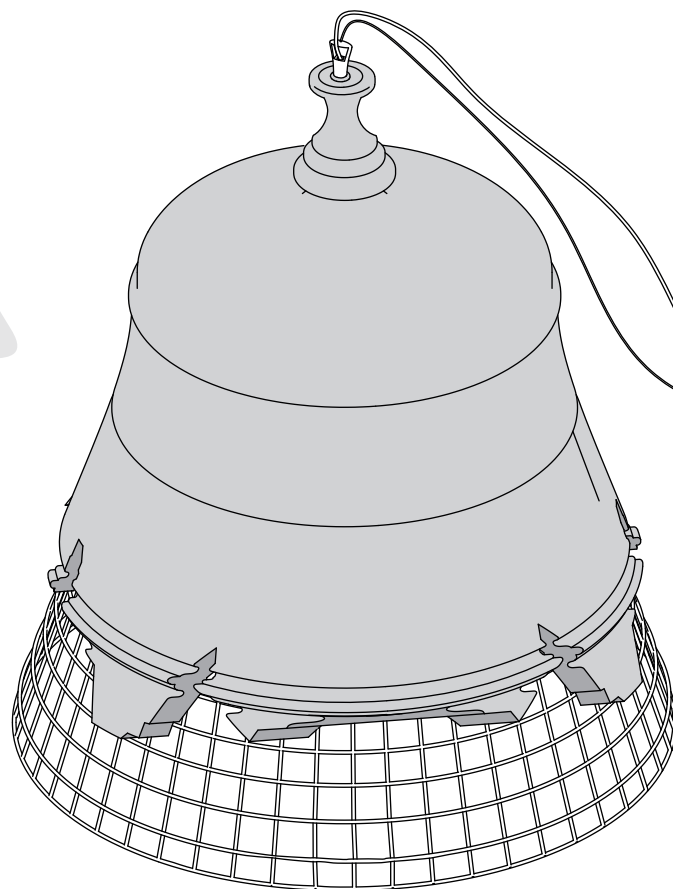
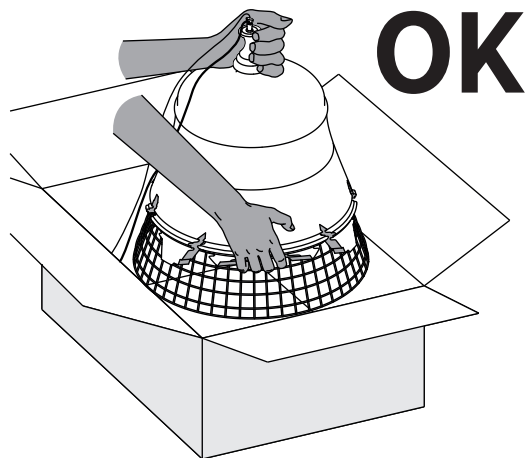

2x F

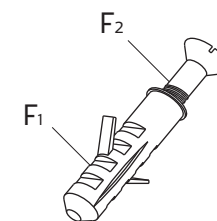

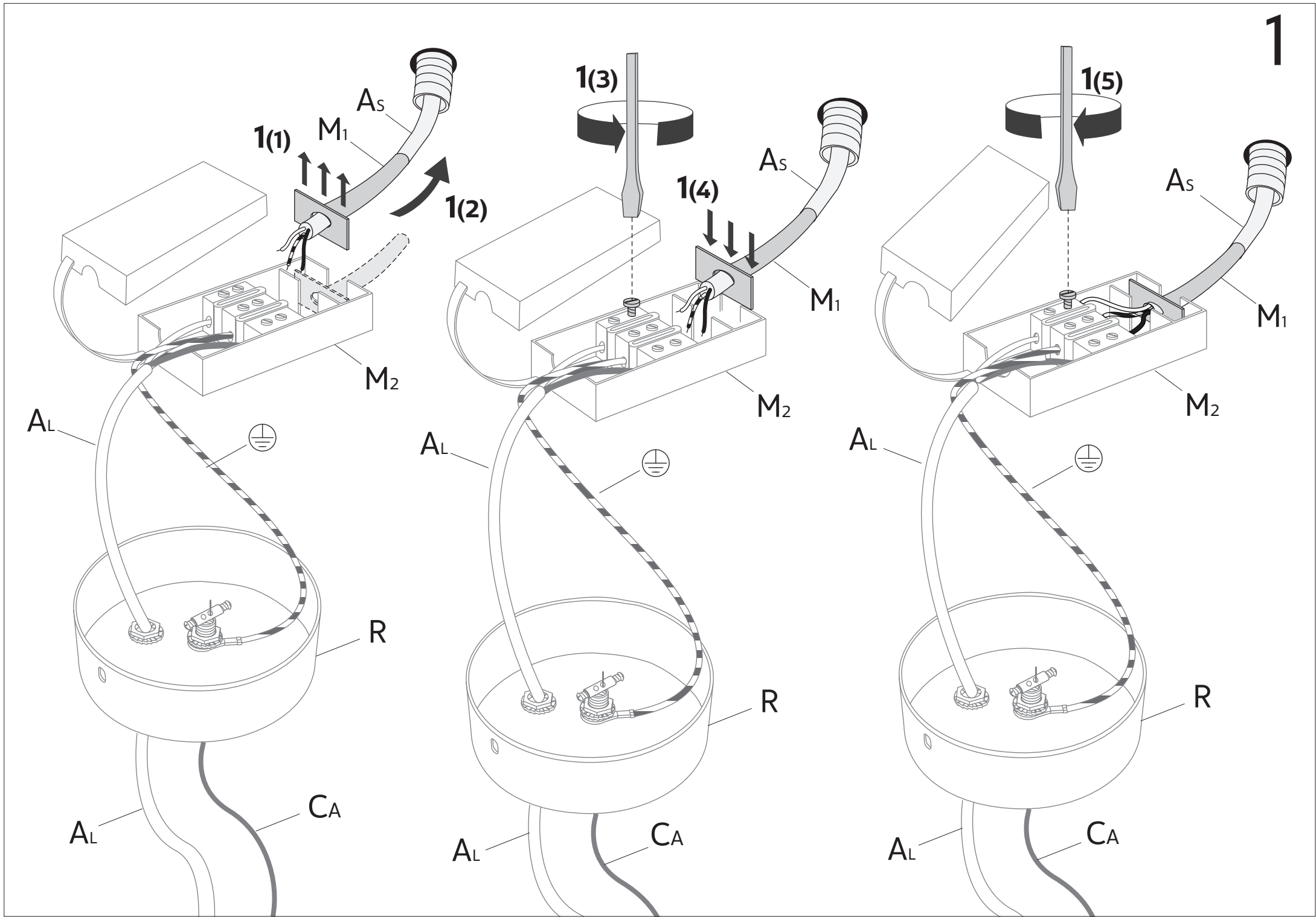



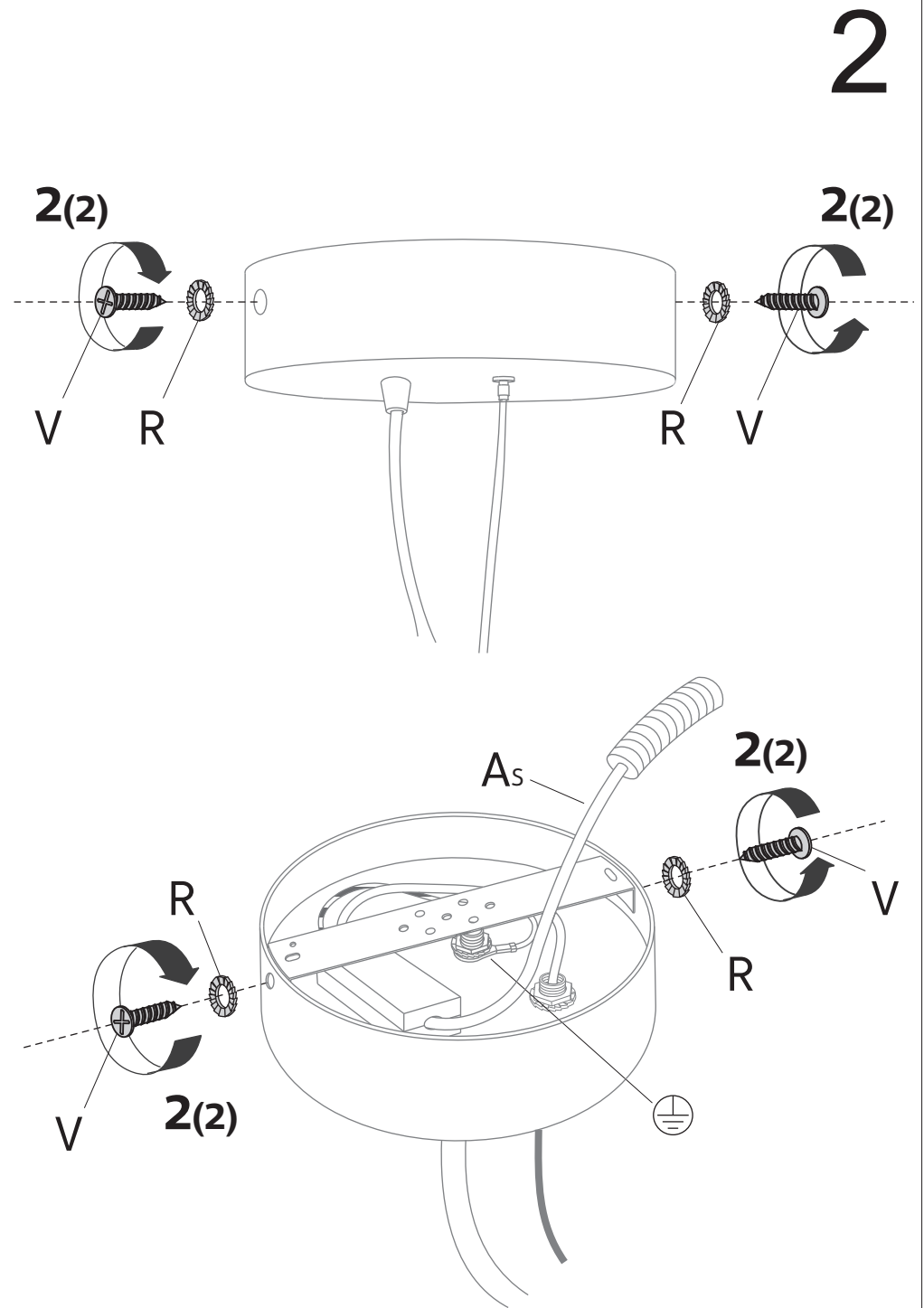
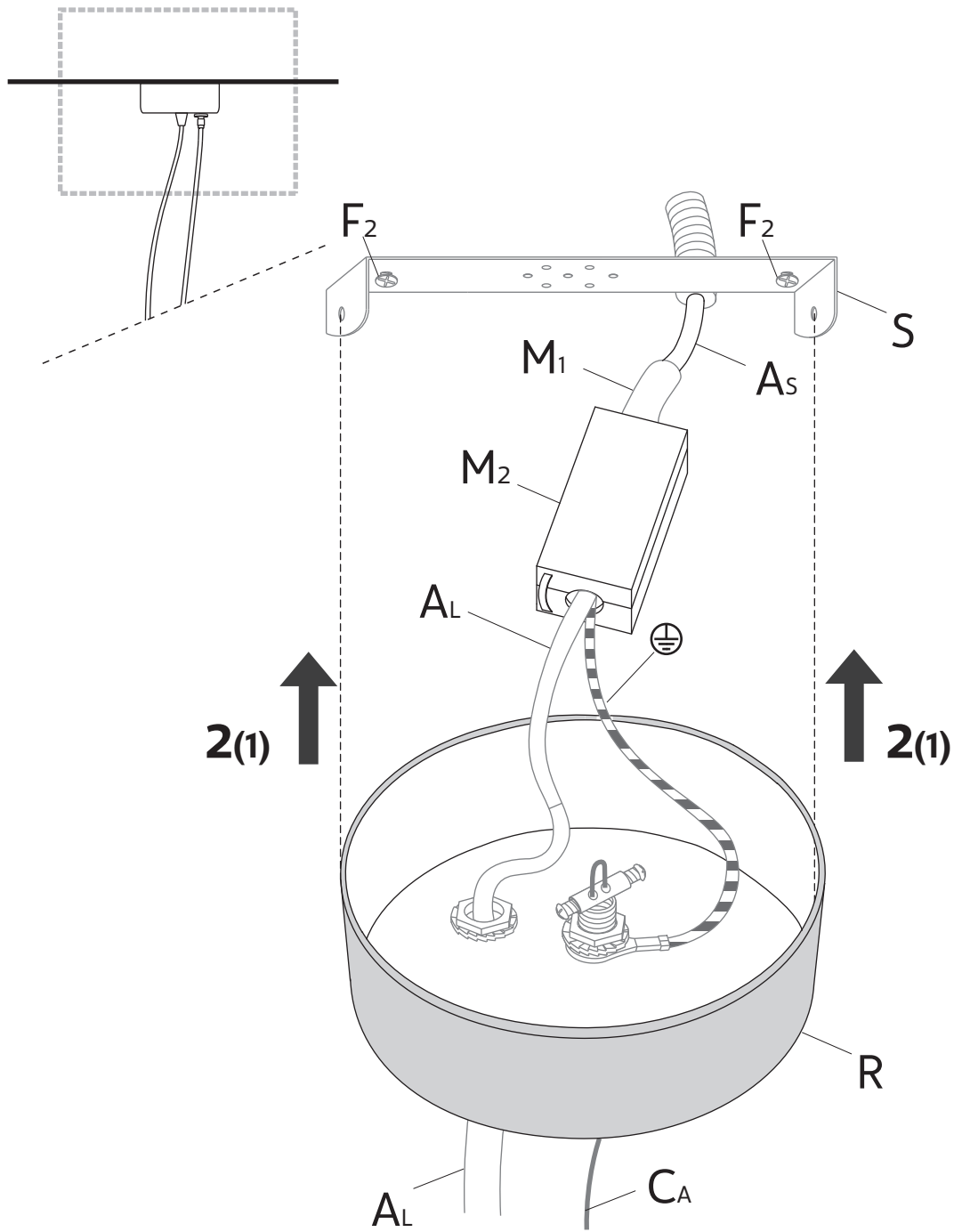

2

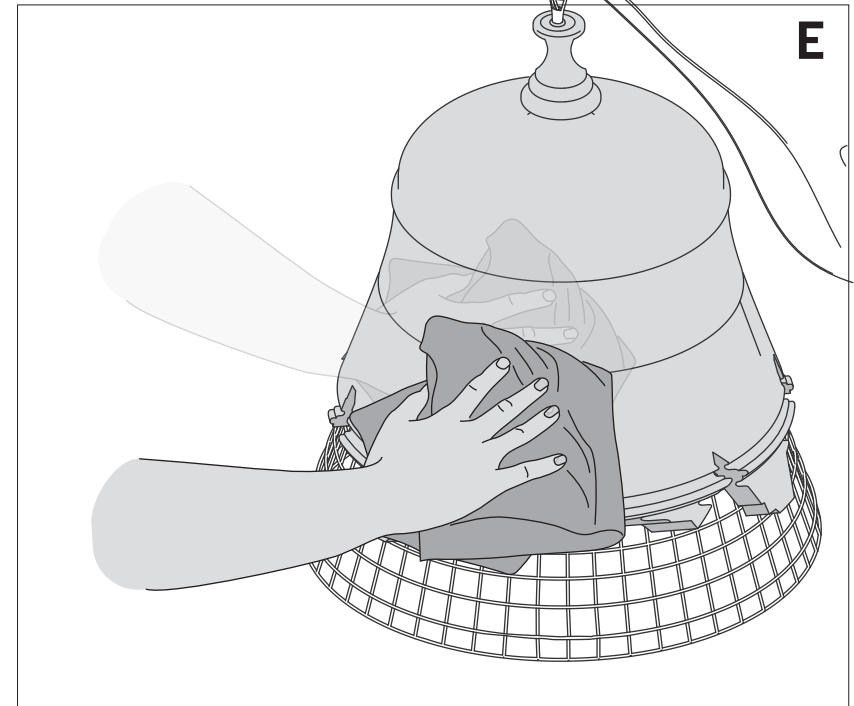
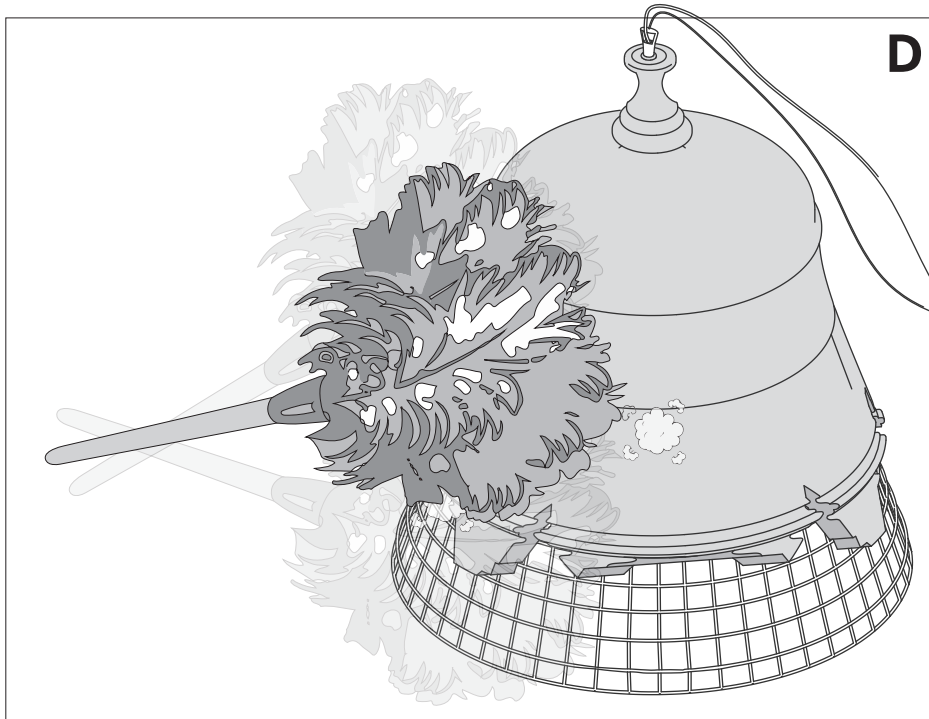
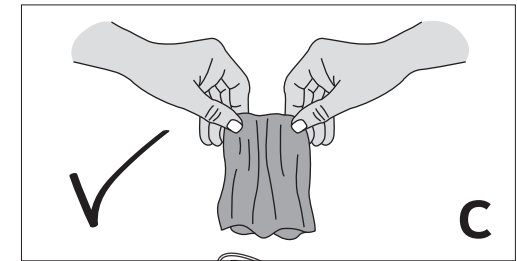
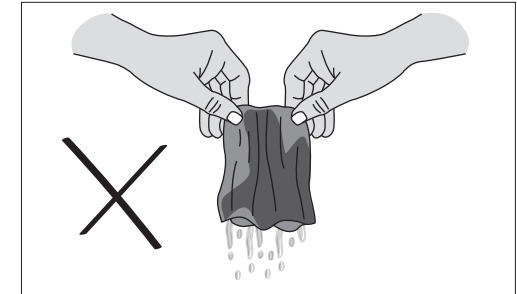
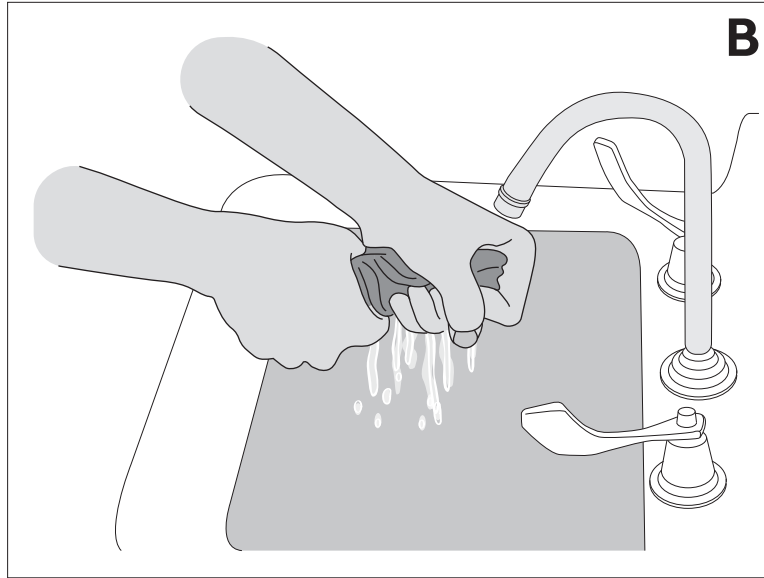
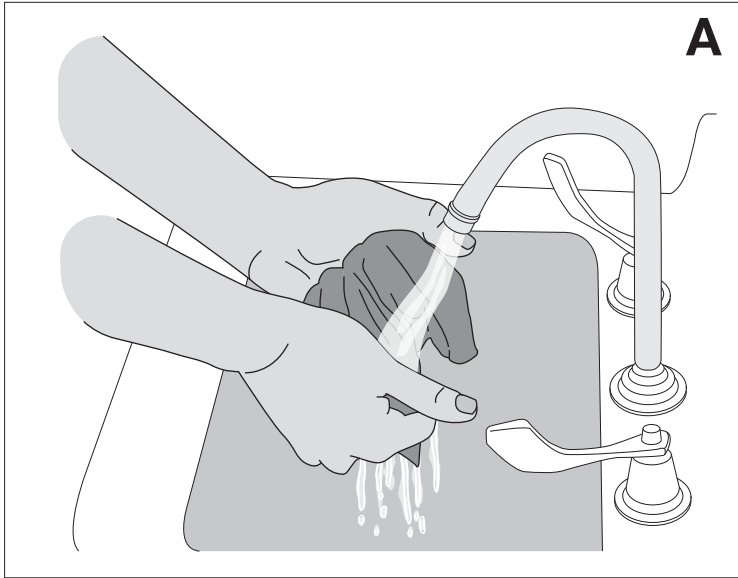

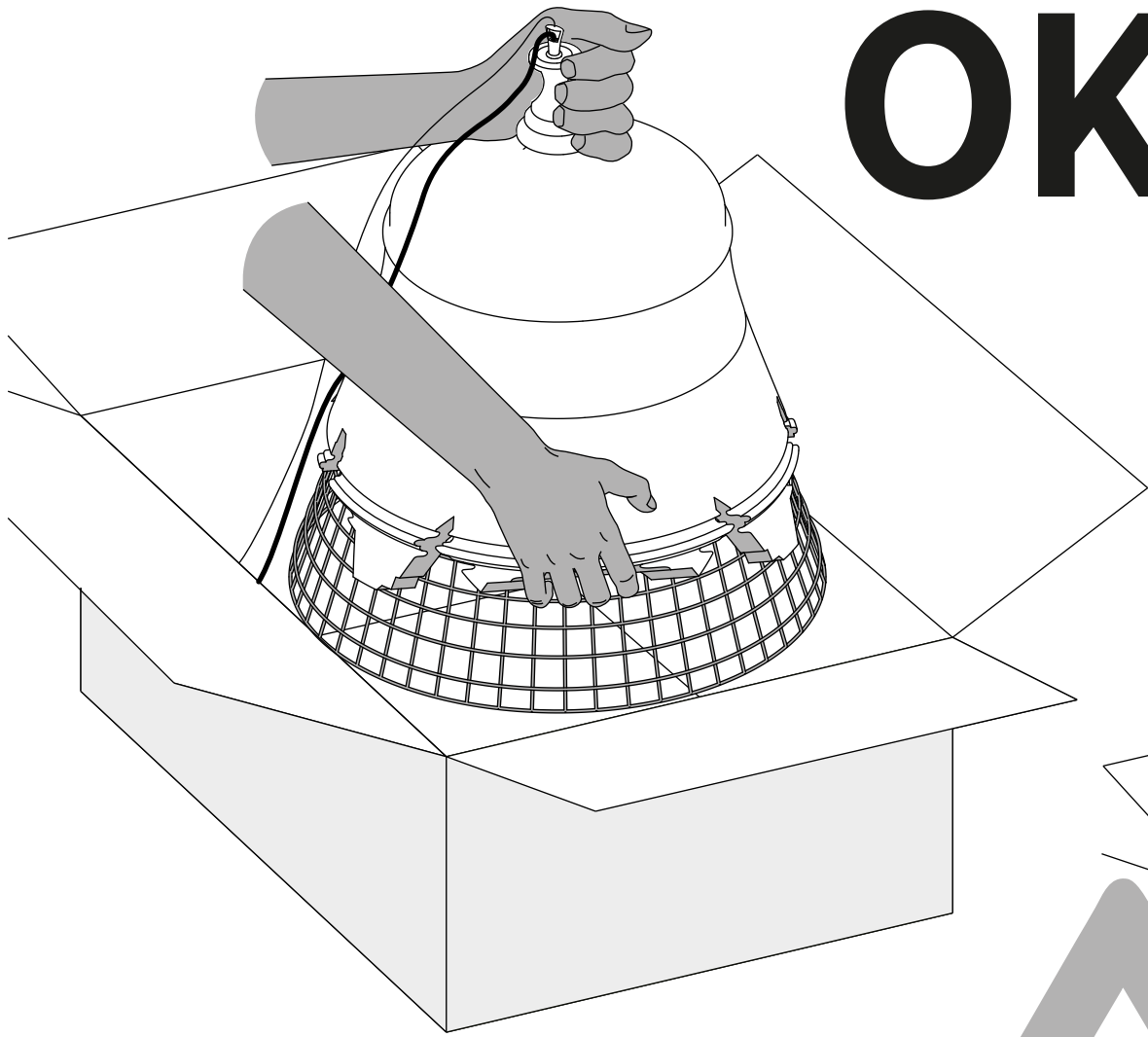

**OK**

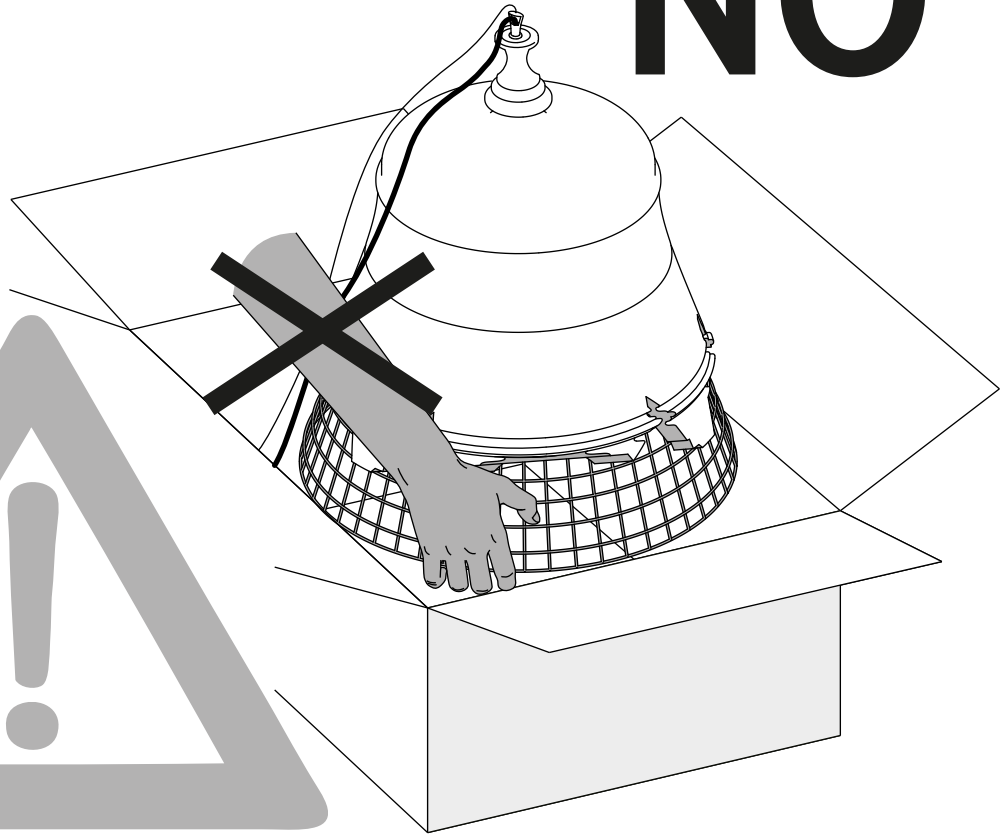

**NO**

