

COUTURE

DESIGNED BY HERVÉ LANGLAIS

Discrète et raffinée, *Couture* est une petite lampe à poser dont l'abat-jour est tout simplement boutonné sur sa tige courbée en laiton.

Sa silhouette toujours changeante à l'élégance classique en fait une pièce stylée pour l'intérieur.



Discrete and refined, *Couture* is a small table lamp with a shade that is simply buttoned to its curved brass stem.









Its ever-changing profile and classic elegance make it a stylish piece for interiors.



Couture SB

**Finitions
Finishes**

Détails page 222

 Laiton satiné SB Satin brass	 Graphite satiné SG Satin graphite	 Nickel satiné SN Satin nickel	 Cuivre satiné SC Satin copper
 Laiton poli PB Polished brass	 Graphite poli PG Polished graphite	 Nickel poli PN Polished nickel	 Cuivre poli PC Polished copper

**Abat-jour
Lampshade**

<input type="checkbox"/> Drop Paper® 100	<input type="checkbox"/> Drop Paper® 101	<input type="checkbox"/> Drop Paper® 103
<input type="checkbox"/> Chinette blanche White chinette		

**Matériaux
Material**

Laiton massif Solid Brass	Abat-jour Drop Paper® M1 Lampshade Drop Paper® M1	Câble textile noir (longueur ≈ 2 m) Black textile cable (length ≈ 79")
------------------------------	--	---

**Source
Lighting**

1 x E14 40W max. Ampoule non fournie 1 x E14 40W max. Bulb not included	Interrupteur sur câble Cable switch
--	--

Designer

Hervé Langlais

Lampe de table – Table lamp

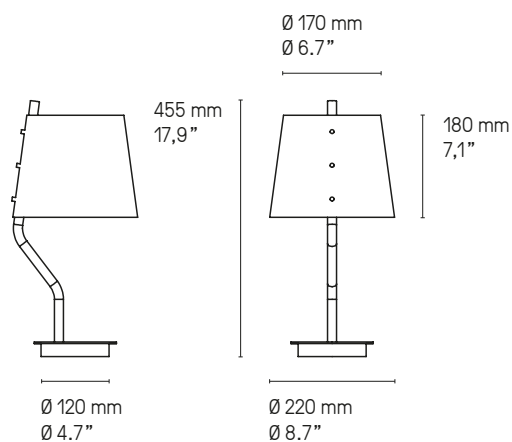

En standard, le dessous de la base sera toujours en finition graphite, si vous préférez une autre finition, merci de le préciser.

As standard, the underside of the base always comes in a satin graphite finish unless specified differently.



Lampe de table – Table lamp Couture SB



Lampe de table – Table lamp Couture SG



© Yannick Labrousse

CVL LUMINAIRES

79 ROUTE DE LA CHEVALLERIE – 49770 LONGUENÉE-EN-ANJOU – FRANCE

TEL. +33 (0) 2 41 32 67 54

EMAIL : CONTACT@CVL-LUMINAIRES.FR

WWW.CVL-LUMINAIRES.FR

Brand identity & art direction: [POOL](#) Layout & production supervision: [deuxpointdeux](#)
Texts & translation: [CVL](#) Photos: [Garnier Studios](#) except when mentionned otherwise 3D: [CVL](#) except when mentionned otherwise

Make sure to download our latest catalogue [here](#)