



USA / deltalight.us / +1(954) 677 9800
 Canada / deltalight.ca / +1(905) 813 6130

Date _____

Name _____

Client _____

Project name _____

Quote# _____

Type/Quantity _____

Listings



25/04/2022 14:52:04

Specification Sheet

LOGIC R1 93055
6 213 471 811 933

[Weblink](#)

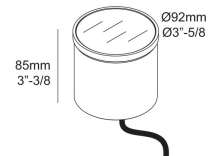
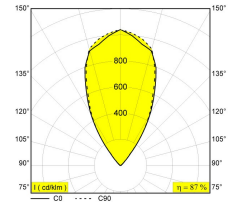

Cutout shape/size: 3" 11/16

Recessed depth: 4" 15/16

Available colors: ALU ANODIZED (6 213 471 811 933 ANO)

INCL.CABLE 2 x 20 AWG 5'
 LED 7,1W / CRI>90 / 3000K / 812lm
 REFLECTOR WFL-55°
 EXCL.LED POWER SUPPLY 24V-DC (non-dimmable)
 For other CRI or KELVIN, contact factory

LED Technics: Light source: 812 lm // 7 W // 115 lm/W
 Luminaire: 710 lm // 8 W // 87 lm/W

24V-DC

Class 2: Yes
 Ada: N.a.

Weight: 2.2 LBS
 Protection level: IP67 - suitable for wet locations
 Minimum distance: n.a.

Options: JUNCTION BOX
 IP68 CONNECTOR 3P

Requirements :
 GENIE BOX 90 R
 LED POWER SUPPLY 24V-DC (Remote)

For detailed installation instructions, please consult the manual. [6_213_471_811_XXX_HAND.pdf](#)

LOGIC R1 93055
6 213 471 811 933

Related references

LED POWER SUPPLIES - REMOTE

[Weblink / Specsheet](#)

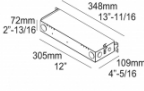

LED POWER SUPPLY 24V-DC / 90W
DIM1
6 300 89 24 90 ED1
120-277V / 60Hz
Number of luminaires: 10

[Weblink / Specsheet](#)

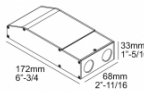

LED POWER SUPPLY 24V-DC / 96W
DIM8
6 300 89 24 96 ED8
120V / 60Hz
Number of luminaires: 11

Related references

GROUND MOUNTING BOXES

[Weblink / Specsheet](#)

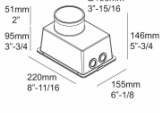

GENIE BOX 90 R
6 213 19 09

Related references

WATERPROOF CONNECTION PARTS

[Weblink / Specsheet](#)

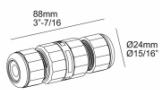

IP68 CONNECTOR 3P
6 216 12 02

[Weblink / Specsheet](#)



IP68 CONNECTOR 5P
6 216 12 03

[Weblink / Specsheet](#)

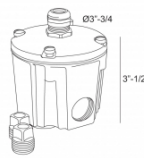

JUNCTION BOX
6 216 12 00

Related project picture of product family:

