

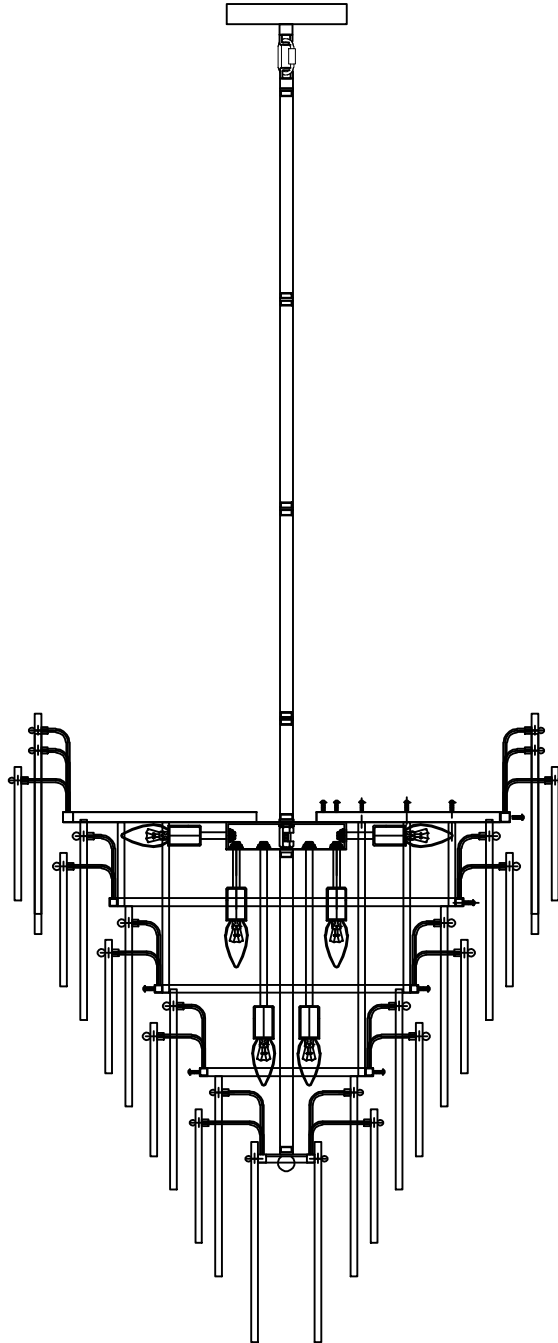

**PRODUCT NAME: Majestic 21-Light Chandelier**  
**ITEM NUMBER: 32328CLCMPGL**



**Please consult your electrician for hanging fixture and wiring.**

**Light Source :21\* E12\*40W (Not include)**

**Made in China / Hecho en China / Fabrique en China**

## General Lighting (Including AC LED)

Before Getting Started	Antes de comenzar	Avant de commencer
Read the instructions carefully prior to assembling the product.	Lire attentivement les instructions avant d'assembler le produit.	Lea atentamente las instrucciones antes de ensamblar el producto.
When you open the package with a sharp tool like a cutter knife, be careful not to damage the components inside.	Lorsque vous ouvrez le paquet avec un outil pointu comme un couteau de coupe, veillez à ne pas endommager les composants à l'intérieur.	Cuando abra el paquete con una herramienta afilada como un cuchillo de corte, tenga cuidado de no dañar los componentes dentro.
Carefully remove all packaging materials and retain for future use.	Retire con cuidado todos los materiales de embalaje y consérvelos para usarlos en el futuro.	Retirez soigneusement tous les matériaux d'emballage et conservez-les pour un usage ultérieur.
Keep all hardware parts and packaging out of reach of small children.	Conservez toutes les pièces matérielles et les emballages hors de portée des petits enfants.	Mantenga todas las piezas y embalajes de hardware fuera del alcance de los niños pequeños.
Choose a clean, level, spacious assembly area. Avoid hard surfaces that may damage the product.	Choisissez une zone d'assemblage propre, de niveau et spacieuse. Évitez les surfaces dures qui pourraient endommager le produit.	Elija una zona de ensamblaje limpia, nivelada y espaciosa. Evite superficies duras que puedan dañar el producto.
Ensure that you have all required contents for complete assembly.	Assurez-vous que vous avez tous les contenus requis pour l'assemblage complet.	Asegúrese de que tiene todos los contenidos necesarios para el ensamblaje completo.
Take care when lifting. Assemble the product in close proximity to where you intend to position the item.	Prenez soin de soulever. Assemblez le produit à proximité de l'endroit où vous comptez positionner l'élément.	Tenga cuidado al levantar. Ensamble el producto cerca de donde tiene la intención de posicionar el artículo.
Do not over tighten the screws and bolts as this may damage the threads.	Ne serrez pas trop les vis et les boulons car cela pourrait endommager les filets.	No apriete excesivamente los tornillos y pernos, ya que esto puede dañar los hilos.
Do not let children play with this product.	No permita que los niños jueguen con este producto.	Ne laissez pas les enfants jouer avec ce produit.
<b>⚠ Risk of suffocation! Keep any packaging materials away from children.</b>	<b>⚠ ¡Riesgo de sofocación! Mantenga los materiales de embalaje lejos de los niños.</b>	<b>⚠ Risque d'asphyxie! Tenez tous les matériaux d'emballage à l'écart des enfants</b>

Lamp Care Instructions	Instrucciones de lámparas	Entretien de la lampe
Carefully read through the instruction sheet before assembly and using the product.	Lea cuidadosamente la hoja de instrucciones (si fue proporcionada) antes de armar y utilizar la lámpara.	Avant de procéder à l'assemblage et à l'utilisation de la lampe, lisez attentivement le mode d'emploi.
Caution there is a risk of shock. Disconnect from power source before assembling or cleaning.	Peligro por descarga eléctrica. Desconecte la lámpara de la fuente de electricidad antes de armarla o limpiarla.	Pour éviter tout risque d'électrocution, débranchez la lampe de la prise électrique avant de procéder à l'assemblage ou au nettoyage de la lampe.
Switch off, unplug and allow bulb to cool before replacing bulb or cleaning.	Apáguela, desenchúfela y deje que la bombilla se enfríe antes de reemplazarla o limpiarla.	Avant de remplacer ou de nettoyer l'ampoule, éteignez et débranchez la lampe.
Only use the recommended bulb type and do not exceed the maximum wattage as it could cause fire.	Solo utilice el tipo de bombilla recomendado y no exceda la potencia eléctrica máxima ya que puede causar un incendio.	Afin d'éviter tout risque de feu, utilisez le type et la puissance d'ampoule recommandés.
Do not plug the product in if cord is torn or frayed.	No conecte la lámpara si el cable eléctrico está dañado o deshilachado.	Ne branchez pas la lampe si son cordon d'alimentation est déchiré ou effiloché.











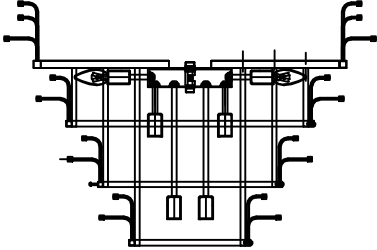



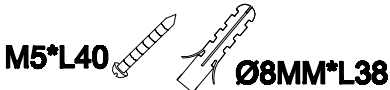

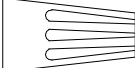
Cleaning & Maintenance	Limpieza y mantenimiento	Nettoyage et maintenance
On polished finishes, often using talc powder reduces the appearance of fingerprints and other smudges.	En acabados pulidos, a menudo usando polvo de talco reduce la aparición de huellas dactilares y otras manchas.	Sur les finitions polies, souvent en utilisant la poudre de talc réduit l'apparence des empreintes digitales et d'autres taches.
For respective shade surfaces, use the appropriate cleansers, i.e. glass cleaner, acrylic polish, and wood polish.	Para las respectivas superficies de sombra, utilice los limpiadores apropiados, es decir, limpiador de vidrio, esmalte acrílico y pulido de madera.	Pour les surfaces d'ombrage respectives, utilisez les nettoyeurs appropriés, c'est-à-dire le nettoyeur pour vitres, le Vernis acrylique et le vernis à bois.
Clean with soft cloth and a mild detergent. DO not use abrasive cleaner.	Utilice un trapo limpio, suave y seco que no raye ni manche la superficie cuando quite el polvo.	Nettoyer avec un chiffon doux et un détergent doux. N'utilisez pas de nettoyeur abrasif.
Periodically (every 90 days) make sure that the screws are fully tightened.	Periódicamente (cada 90 días) asegúrese de que los tornillos estén bien apretados.	Périodiquement (tous les 90 jours), assurez-vous que les vis sont bien serrées.
Prolonged exposure to heat sources may cause glazing, melting and scorching, or even cause color to fade.	La exposición prolongada a las fuentes de calor causa cristalización, derretimiento, quemadura y decoloración del tapizado.	Si le tissu subit une exposition prolongée aux sources de chaleur, il pourrait commencer à reluire, à roussir, à s'estomper ou même à se décolorer.

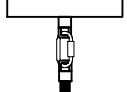
# EN Contents

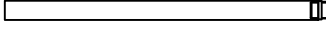
Before getting started, ensure the package contains the following components:

Antes de comenzar, asegúrese de que el paquete contenga los siguientes componentes:

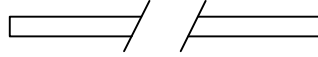
Avant de commencer, assurez-vous que le paquet contient les composants suivants:

A	 <b>Fixture</b>	X1	J	 <b>Small M4 round Nut</b>	X149
			K	 <b>Big M10 round Nut</b>	X1
B	 <b>Mounting Bracket</b>	X1	L	 <b>Finial</b>	X4
C	 <b>Anchor Bolts</b>	X12	M	 <b>GLS32320CL-B</b>	X31
D	 <b>Wire nuts</b>	X3	O	 <b>GLS32320CMP-B</b>	X28
E	 <b>Canopy</b>	X1	P	 <b>LEA32320GL-B</b>	X18
F	 <b>Long Stem: STR07512GL-LX</b>	X3	Q	 <b>GLS32320CL-A</b>	X30
G	 <b>Short: STR07506GL-LX</b>	X1	R	 <b>GLS32320CMP-A</b>	X25
H	 <b>Connection rod</b>	X1	S	 <b>LEA32320GL-A</b>	X17
I	 <b>Frame: Bottom part</b>	X1			

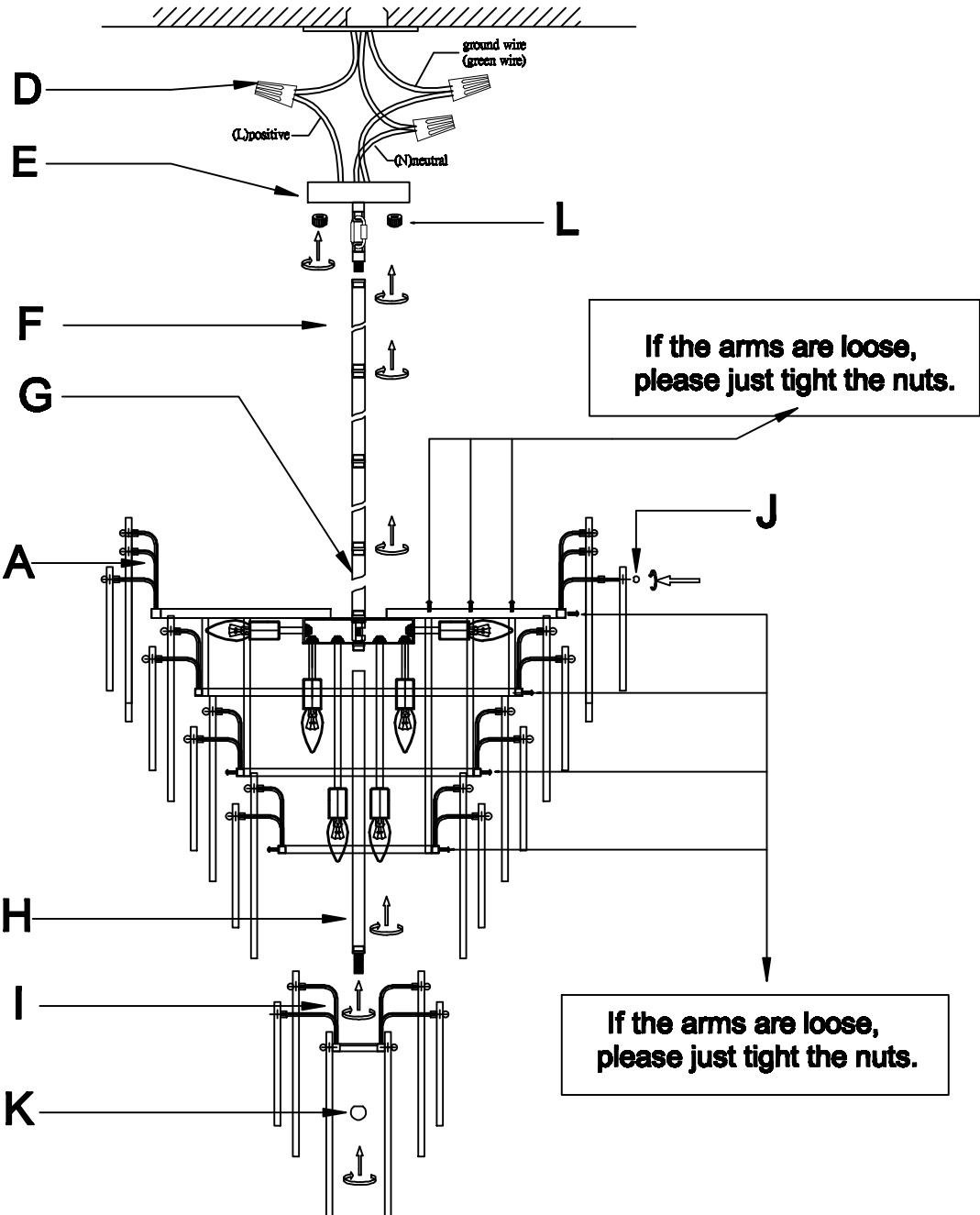
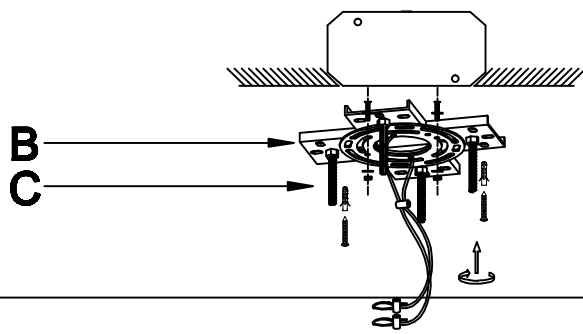

**Run wire through stems(F & G), and combine stem lengths to meet desired mounting height. Connect canopy(E) by tightening stems.**



**Crystal Diagram**

Item Number:32328CLCMPGL

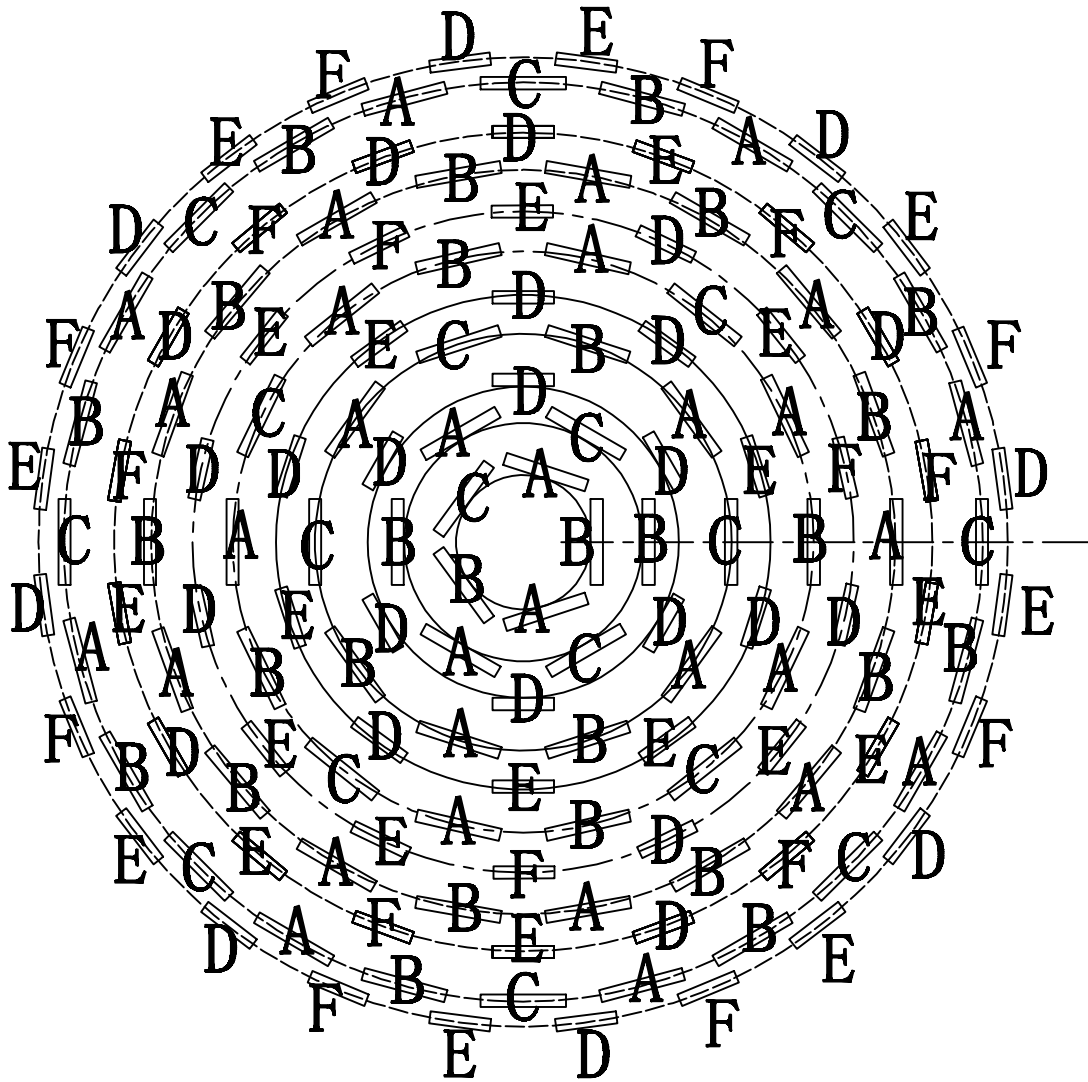

CRY Code	MAXIM CRY#	QTY	COLOR
A	GLS32320CL-B	31 pcs	Clear, big glass
B	GLS32320CMP-B	28 pcs	Cognac, big glass
C	LEA32320GL-B	18 pcs	Golden leaf, big metal
D	GLS32320CL-A	30 pcs	Clear, Small glass
E	GLS32320CMP-A	25 pcs	Cognac, Small glass
F	LEA32320GL-A	17 pcs	Golden leaf, Small metal

GLS32320CL-B  
\*31PCS

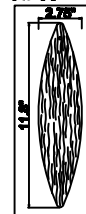

GLS32320CMP-B  
\*28PCS

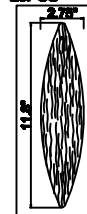

LEA32320GL-B  
\*18PCS

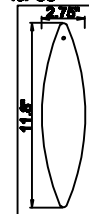

GLS32320CL-A  
\*30PCS



GLS32320CMP-A  
\*25PCS

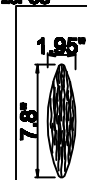

LEA32320GL-A  
\*17PCS

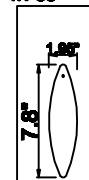

**Crystal Diagram**  
**Item Number:32328CLCMPGL**

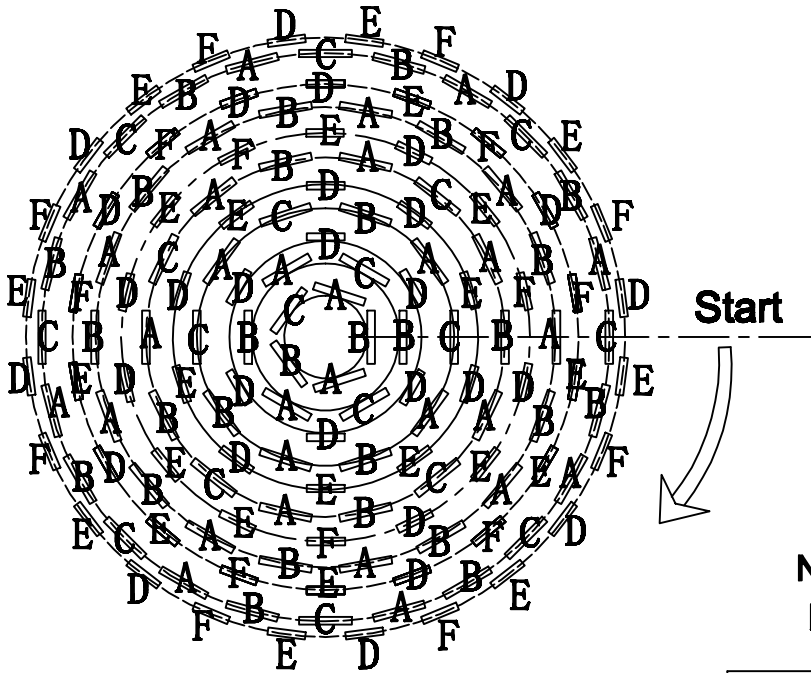

**Note: It is best to start at same position for each level.**

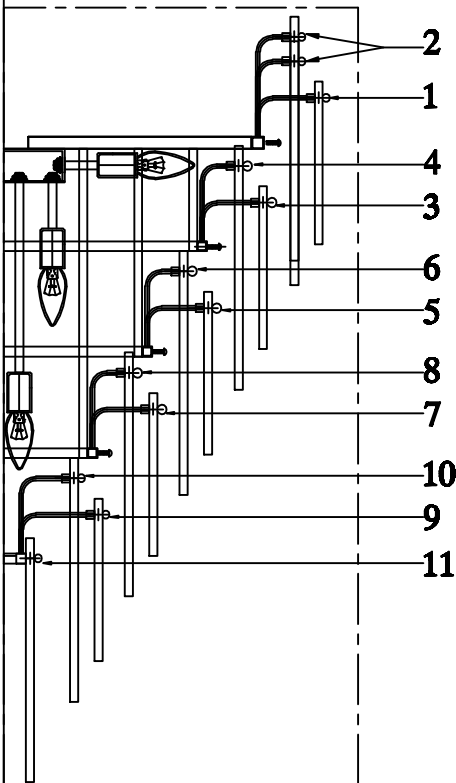

Layer #	CRY Code	Description	Total Qty
1	D、E、F	8pcs x small clear glass(D) 8pcs x small cognac glass(E) 8pcs x small golden leaf(F)	24PCS
2	A、B、C	8pcs x big clear glass(A) 8pcs x big cognac glass(B) 8pcs x big golden leaf(C)	24PCS
3	D、E、F	6pcs x small clear glass(D) 6pcs x small cognac glass(E) 6pcs x small golden leaf(F)	18PCS
4	A、B	9pcs x big clear glass(A) 9pcs x big cognac glass(B)	18PCS
5	D、E、F	5pcs x small clear glass(D) 6pcs x small cognac glass(E) 3pcs x small golden leaf(F)	14PCS
6	A、B、C	6pcs x big clear glass(A) 4pcs x big cognac glass(B) 4pcs x big golden leaf(C)	14PCS
7	D、E	5pcs x small clear glass(D) 5pcs x small cognac glass(E)	10PCS
8	A、B、C	4pcs x big clear glass(A) 3pcs x big cognac glass(B) 3pcs x big golden leaf(C)	10PCS
9	D	6pcs x small clear glass(D)	6PCS
10	A、B、C	2pcs x big clear glass(A) 2pcs x big cognac glass(B) 2pcs x big golden leaf(C)	6PCS
11	A、B、C	2pcs x big clear glass(A) 2pcs x big cognac glass(B) 1pcs x big golden leaf(C)	5PCS