

Date _____

Name _____

Client _____

Project name _____

Quote# _____

Type/Quantity _____

Features

Powder coated aluminum

Application

For indication lighting Residential, commercial, retail, and hospitality spaces

Dimming Options

Refer to housing or power supply spec sheet.

Listings



Specification Sheet

INLET S WW 6 304 05 12

[Weblink](#)

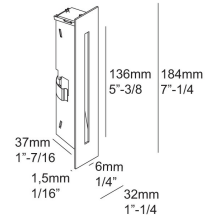
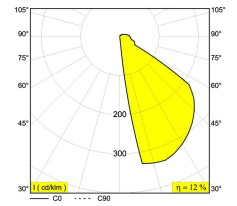

Cutout shape/size:	7/8" x 6" 11/16
Recessed depth:	1" 3/4
Available colors:	ALU GREY (6 304 05 12 A) WHITE (6 304 05 12 W)
LED 1,1W / CRI>80 / 3000K / 120lm EXCL.LED POWER SUPPLY 350mA-DC For other CRI or KELVIN, contact factory	
LED Technics:	Light source: 132 lm // 1 W // 132 lm/W Luminaire: 16 lm // 2 W // 8 lm/W
Class 2	Yes
Ada	N.a.
Weight:	0.4 LBS
Protection level:	IP20 - suitable for damp locations
Minimum distance:	n.a.
Options:	PLASTERKIT 145 CONCRETE BOX 145 MOUNTING KIT FLUSH INLET
Requirements :	LED POWER SUPPLY 350mA-DC DIM (Remote)

For detailed installation instructions, please consult the manual. [6_304_05_12_HAND.pdf](#)

25/04/2022 09:43:41

INLET S WW
6 304 05 12

Related references

LED POWER SUPPLIES - REMOTE

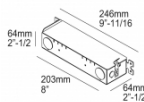
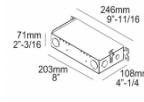
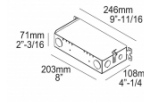
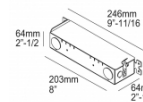
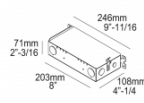
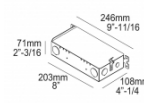
<p>Weblink / Specsheet</p>  <p>LED POWER SUPPLY 350mA-DC / 11W DIM8 6 300 46 ED8 120V / 60Hz Number of luminaires: 3 -> 9</p>	<p>Weblink / Specsheet</p>  <p>LED POWER SUPPLY 350mA-DC / 13W DIM12 6 300 70 ED12 120V / 60Hz Number of luminaires: 6 -> 10</p>	<p>Weblink / Specsheet</p>  <p>LED POWER SUPPLY 350mA-DC / 19W DIM1 6 300 44 ED1 120-277V / 60Hz Number of luminaires: 4 -> 15</p>	<p>Weblink / Specsheet</p>  <p>LED POWER SUPPLY 350mA-DC / 19W DIM13 6 300 41 ED13 120-277V / 60Hz Number of luminaires: 4 -> 15</p>
<p>Weblink / Specsheet</p>  <p>LED POWER SUPPLY MULTI-POWER DIM7 6 300 15 120V / 60Hz Number of luminaires: 12 / - / -</p>	<p>Weblink / Specsheet</p>  <p>LED POWER SUPPLY MULTI-POWER DIM13 6 300 14 ED7 120V / 60Hz Number of luminaires: 6 -> 12 / - / -</p>		

Related references

PLASTERKITS

<p>Weblink / Specsheet</p>  <p>PLASTERKIT 145 304 05 99</p>

Related references

CONCRETE BOXES

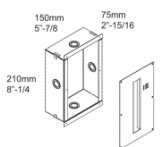
<p>Weblink / Specsheet</p>  <p>CONCRETE BOX 145 304 05 98</p>

Related references

MOUNTING KITS

[Weblink / Specsheat](#)

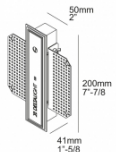

MOUNTING KIT FLUSH INLET S
304 05 01

 DELTALIGHT®

USA / deltalight.us / +1(954) 677 9800
Canada / deltalight.ca / +1(905) 813 6130

Specification Sheet

INLET S WW
6 304 05 12

Related project picture of product family:

