



USA / [deltalight.us](http://deltalight.us) / +1(954) 677 9800  
 Canada / [deltalight.ca](http://deltalight.ca) / +1(905) 813 6130

Date \_\_\_\_\_

Name \_\_\_\_\_

Client \_\_\_\_\_

Project name \_\_\_\_\_

Quote# \_\_\_\_\_

Type/Quantity \_\_\_\_\_

**Features**

Powder coated stainless steel construction

**Application**

For indication lighting Residential, commercial, retail, and hospitality spaces

**Dimming Options**

Refer to housing or power supply spec sheet.

**Listings**



Specification Sheet

**HELI X SCREEN LED NW**

**6 202 04 24**

[Weblink](#)

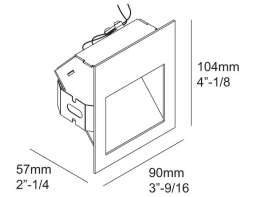
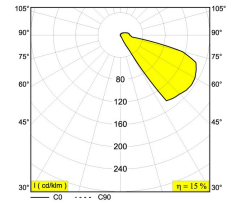

Cutout shape/size: 2" 15/16 x 3" 7/16

Recessed depth: 2" 3/8

Available colors: ALU GREY (6 202 04 24 A)  
DARK GREY (6 202 04 24 N)

1 x LED 1W / CRI>80 / 4000K / 134lm  
 EXCL.LED POWER SUPPLY 350mA-DC  
 For other CRI or KELVIN, contact factory

LED Technics: Light source: 134 lm // 1 W // 134 lm/W  
Luminaire: 20 lm // 2 W // 10 lm/W

Class 2: Yes  
 Ada: N.a.

Weight: 0.7 LBS  
 Protection level: IP54 - suitable for wet locations  
 Minimum distance: n.a.

Options: CONCRETE BOX 187

**Requirements :**  
 LED POWER SUPPLY 350mA-DC DIM (Remote)

For detailed installation instructions, please consult the manual. [6\\_202\\_04\\_22\\_HAND.pdf](#)

25/04/2022 09:33:15

**HELI X SCREEN LED NW**  
**6 202 04 24**

**Related references**

**LED POWER SUPPLIES - REMOTE**

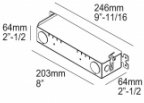
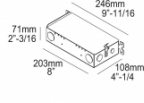
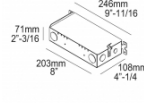
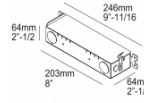
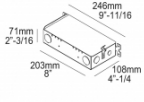
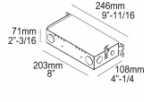
<p><a href="#">Weblink / Specsheet</a></p>  <p>LED POWER SUPPLY 350mA-DC / 11W              DIM8              6 300 46 ED8              120V / 60Hz              Number of luminaires: 3 -&gt; 9</p>	<p><a href="#">Weblink / Specsheet</a></p>  <p>LED POWER SUPPLY 350mA-DC / 13W              DIM12              6 300 70 ED12              120V / 60Hz              Number of luminaires: 6 -&gt; 10</p>	<p><a href="#">Weblink / Specsheet</a></p>  <p>LED POWER SUPPLY 350mA-DC / 19W              DIM1              6 300 44 ED1              120V / 60Hz              Number of luminaires: 4 -&gt; 15</p>	<p><a href="#">Weblink / Specsheet</a></p>  <p>LED POWER SUPPLY 350mA-DC / 19W              DIM13              6 300 41 ED13              120-277V / 60Hz              Number of luminaires: 4 -&gt; 15</p>
<p><a href="#">Weblink / Specsheet</a></p>  <p>LED POWER SUPPLY MULTI-POWER              DIM7              6 300 15              120V / 60Hz              Number of luminaires: 12 / - / -</p>	<p><a href="#">Weblink / Specsheet</a></p>  <p>LED POWER SUPPLY MULTI-POWER              DIM14              6 300 14 ED7              120V / 60Hz              Number of luminaires: 6 -&gt; 12 / - / -</p>		

**Related references**

**CONCRETE BOXES**

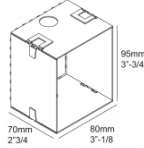
<p><a href="#">Weblink / Specsheet</a></p>  <p>CONCRETE BOX 187              270 11 187</p>
--

HELI X SCREEN LED NW  
6 202 04 24

Related project picture of product family:

