

Date _____

Name _____

Client _____

Project name _____

Quote# _____

Type/Quantity _____

Listings



Specification Sheet

BOXY R 93533 DIM8 6 251 70 811 952 ED8

[Weblink](#)

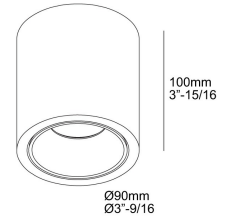
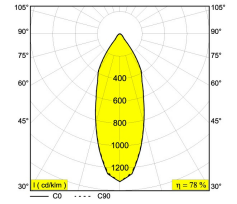

Available colors: BLACK-BLACK (6 251 70 811 952 ED8 B-B)
 BLACK-GOLD MATT (6 251 70 811 952 ED8 B-MMAT)
 WHITE-BLACK (6 251 70 811 952 ED8 W-B)
 WHITE-WHITE (6 251 70 811 952 ED8 W-W)
 BLACK-FLEMISH GOLD (6 251 70 811 952 ED8 B-FG)
 BLACK-FLEMISH BRONZE (6 251 70 811 952 ED8 B-FBR)

1 x LED 10,4W / CRI>90 / 3500K / 1163lm
 REFLECTOR FL-33°
 INCL.DIMMABLE LED POWER SUPPLY 500mA-DC
 MAINS DIMMING
 For other CRI or KELVIN, contact factory

LED Technics: Light source: 1163 lm // 10 W // 112 lm/W
 Luminaire: 910 lm // 12 W // 76 lm/W

120V / 60Hz

Class 2 N.a.
 Ada N.a.
 Installation methods BACKPLATE
 MUD KIT INSTALLATION

Weight: 1.3 LBS
 Protection level: IP53 - suitable for damp locations
 Minimum distance: n.a.

Remarks: For other voltages or dimming options, contact factory.

Accessories: BOXY HONEYCOMB
 BOXY SOFTENING LENS
 BOXY GLASS SBL

Requirements :
 MUD KIT 2
 COVERPLATE R 117

For detailed installation instructions, please consult the manual. [6_251_70_811_XXX_ED8_HAND.pdf](#)

BOXY R 93533 DIM8
6 251 70 811 952 ED8

Related references

MUD KITS

[Weblink / Specsheet](#)

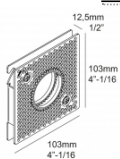

MUD KIT 2
6 207 02 02

Related references

COVER PLATES

[Weblink / Specsheet](#)

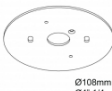

COVERPLATE R 117
6 204 00 117

Related references

LIGHT ALTERING DEVICES

[Weblink / Specsheet](#)

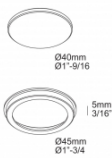

BOXY GLASS SBL
251 70 03 05

[Weblink / Specsheet](#)

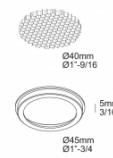

BOXY HONEYCOMB
251 70 03 01

[Weblink / Specsheet](#)

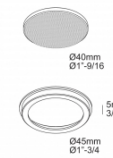

BOXY SOFTENING LENS
251 70 03 04

BOXY R 93533 DIM8
6 251 70 811 952 ED8

Related project picture of product family:

