



WHISKEY

4.5" BROAD, 6" SUSPENSION
WHS-SU-X-BR6

PROJECT: _____

TYPE: _____ DATE: _____

NOTES: _____



FEATURES

With its robust yet elegant extruded aluminum body and powder coated paint finish Whiskey LED cylinders are both visually stunning and highly functional. There are several different models designed to suit, surface, suspended and wall mount installations. These fixtures are available in two diameters (slim and broad) and three different lengths. With their wide range of installation types, fixture sizes and lumen packages Whiskey LED cylinders are ideal for commercial, residential and hospitality settings.

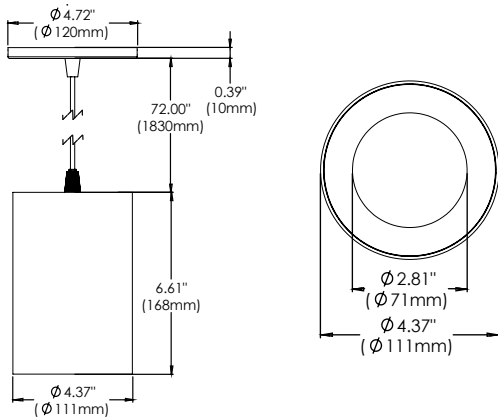

BAFFLE FINISHES

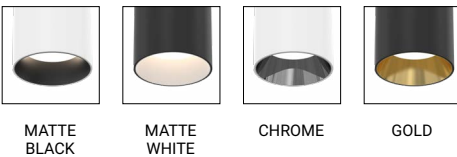

SPECIFICATIONS

FIXTURE BODY	Extruded aluminum body powder coat painted
INSTALLATION TYPE	Mounts over existing octagon box. Canopy cover included
CYLINDER DIMENSIONS	H: 6.61" x Dia: 4.37"
COLOR FINISH	Black/White/Custom
LIGHT MODULE	High output, high efficiency LED COB. Lumen Maintenance: 70%@50,000 hrs
INPUT VOLTAGE	120V - 277V
WATTAGE	13W, 26W
POWER SUPPLY	ERP, Constant Current 350mA or 700mA power supply located inside the top of the cylinder body. Minimum operating temperature: -30°
CRI	90+
DIMMING	TRIAC/ELV/0-10V
DELIVERED LUMENS	13W - 1260 Lumens, 26W - 2030 Lumens, Dim to warm: 13W, 1830 Lumens
CCT OPTIONS	2700K/3000K/3500K/4000K DTW (Dim to warm)
BAFFLE OPTIONS	(01) Matte Black (02) Matte White (03) Chrome (04) Gold
REFLECTORS	(N) Narrow 15° (M) Medium 24° (W) Wide 38°
DIFFUSERS	(CL) Clear (LN) Linear Spread (HC) Honeycomb (FR) Frosted (SP) Solite
APPROVAL	Damp
ELECTRICAL APPROVAL	Compliant
WARRANTY	

SPECIFICATION GUIDE

WHISKEY	SUSPENSION	FINISH	CYLINDER SIZE	WHISKEY BAFFLE FINISH	WATTAGE	CCT	BEAM ANGLE	DIFFUSER
WHS	SU	01 BLACK	BR6 BROAD 6"	01 MATTE BLACK	13 13W	27	N 15°	CL CLEAR
		02 WHITE		02 MATTE WHITE	26 26W	30	M 24°	LN LINEAR SPREAD
				03 CHROME		35	W 38°	HC HONEYCOMB
				04 GOLD		40		FR FROSTED
						DTW 13W Only	SP SOLITE	

ORDERING GUIDE EXAMPLE 1:

Whiskey / Suspension / Black / Broad 6" / Chrome / 13W / 3000K / 38° Beam Angle / Clear Diffuser

CODE: WHS-SU-01-BR6-03-13-30-W-CL

REFLECTOR OPTIONS

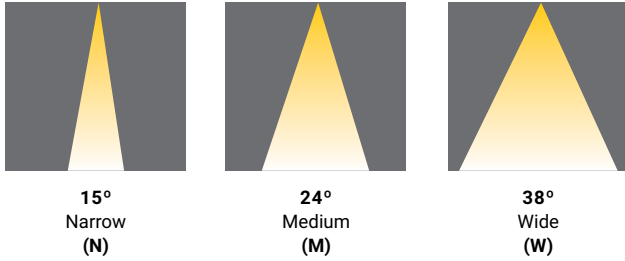

DIFFUSER OPTIONS

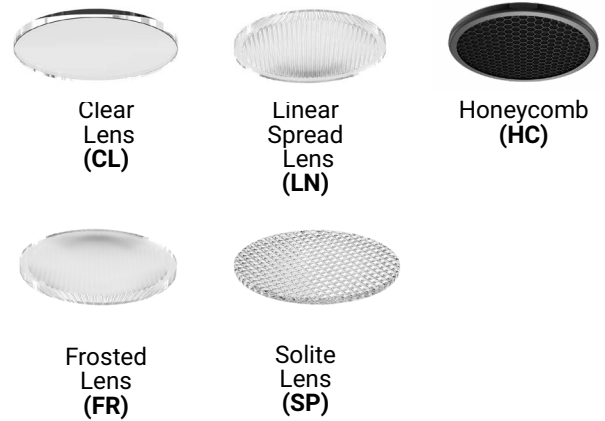

DRIVERS

- Compatible with TRIAC (forward-phase or leading-edge) ELV (reverse-phase or trailing edge) and 0-10V dimmers.
- ESSxxxW models: TRIAC and ELV dimming only at 120 Vac
- ESSxxxW models: ELV dimming only at 230 Vac
- 90° C maximum case hot spot temperature
- Class 2 power supply
- Lifetime: 50,000 hours at 70° case hot spot temperature (some models have a higher lifetime)
- IP64-rated (IP66 for ESST) case with silicone-based potting
- Protections: Output open load, over-current and short-circuit (hiccup), and over-temperature with auto recovery.
- Conducted and radiated EMI: Compliant with FCC CFR Title 47 Part 15 Class B (120 Vac) and Class A (277 Vac), and EN55015 (CISPR 15) at 220, 230, and 240 Vac.
- Complies with ENERGY STAR®, DLC (DesignLight Consortium®) and CA Title 24 technical requirements
- Worldwide safety approvals

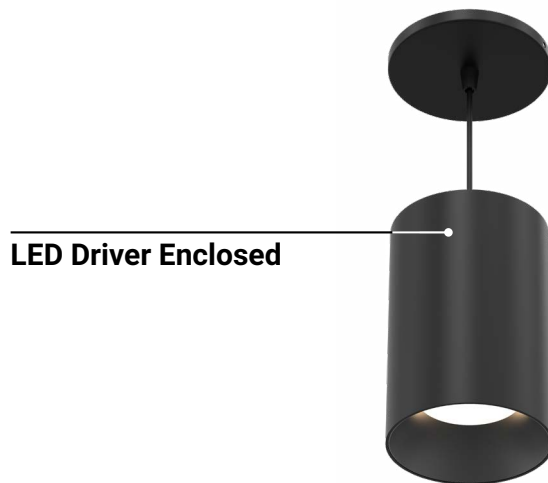

* **PHOTOMETRICS ON NEXT PAGE** ►

PHOTOMETRICS (Metrics)

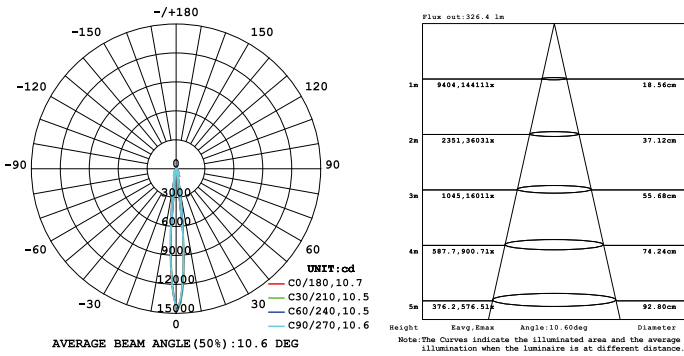

13W NARROW CLEAR-BROAD

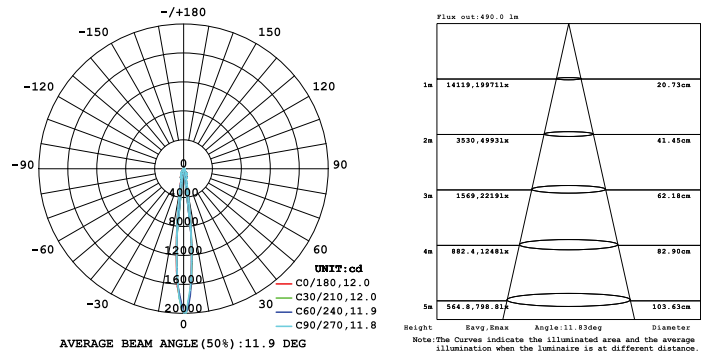

26W NARROW CLEAR-BROAD

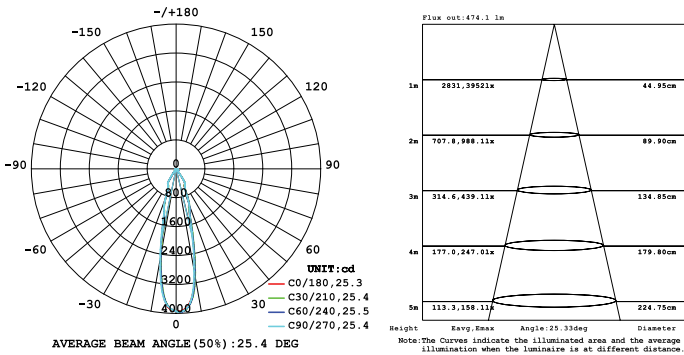

13W MEDIUM CLEAR-SLIM

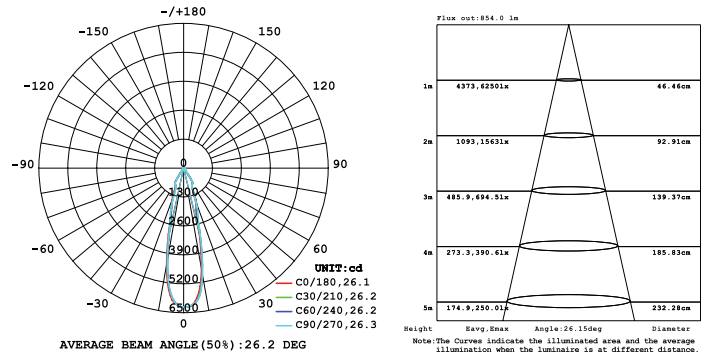

26W MEDIUM CLEAR-SLIM

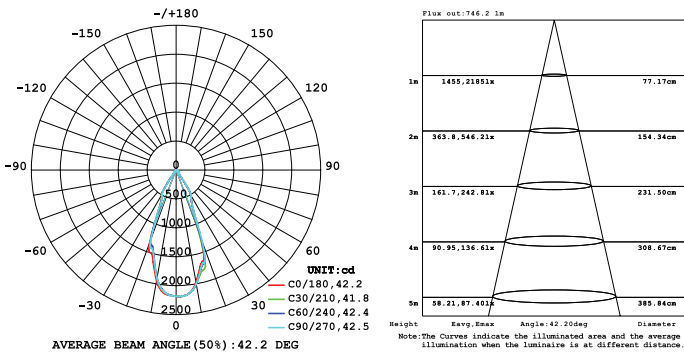

13W WIDE CLEAR-SLIM

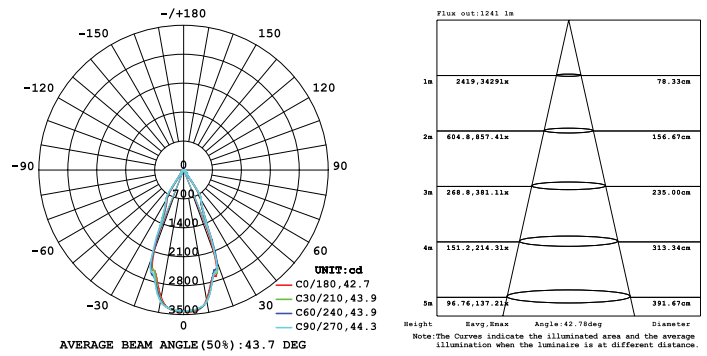

26W WIDE CLEAR-SLIM

PHOTOMETRICS (Imperial)

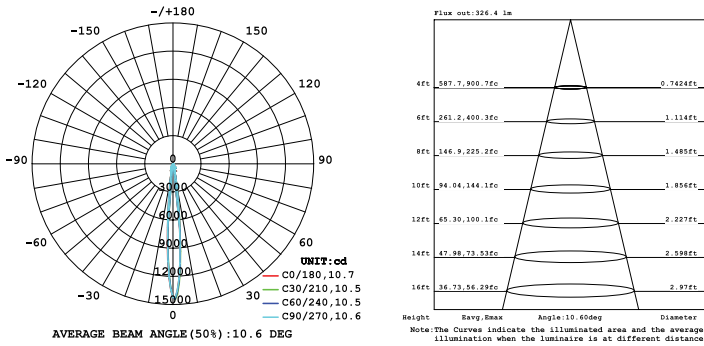

13W NARROW CLEAR-BROAD

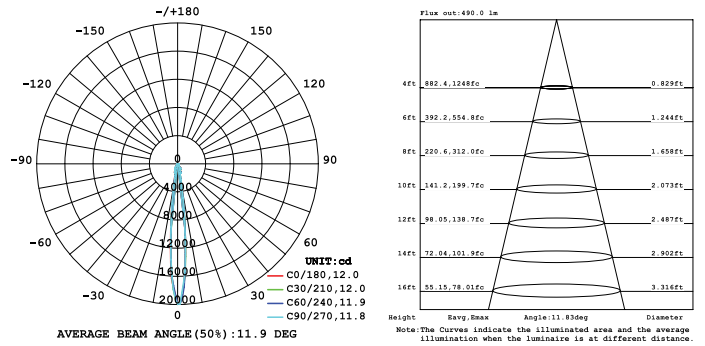

26W NARROW CLEAR-BROAD

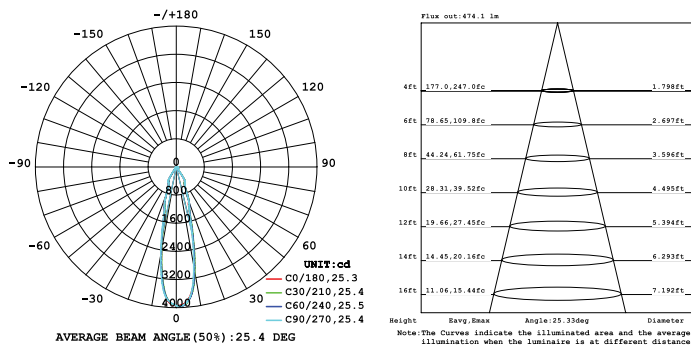

13W MEDIUM CLEAR-SLIM

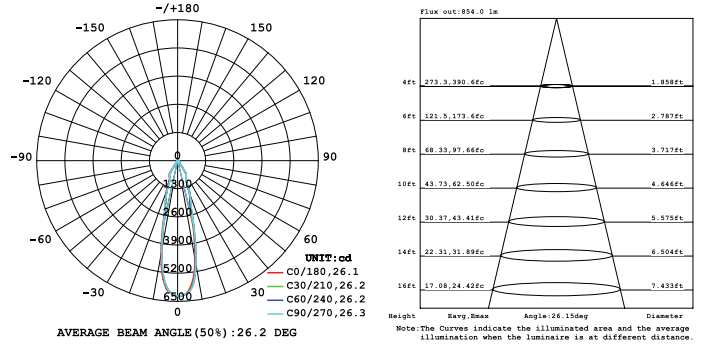

26W MEDIUM CLEAR-SLIM

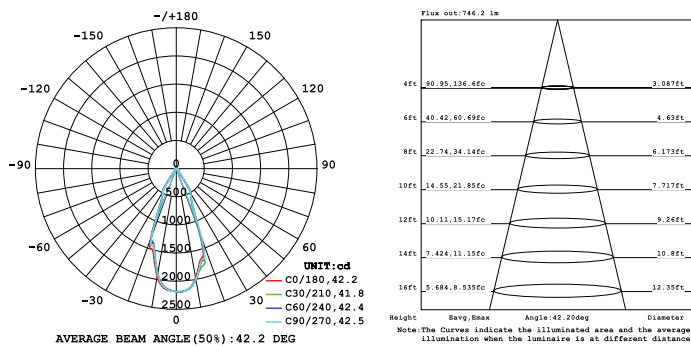

13W WIDE CLEAR-SLIM

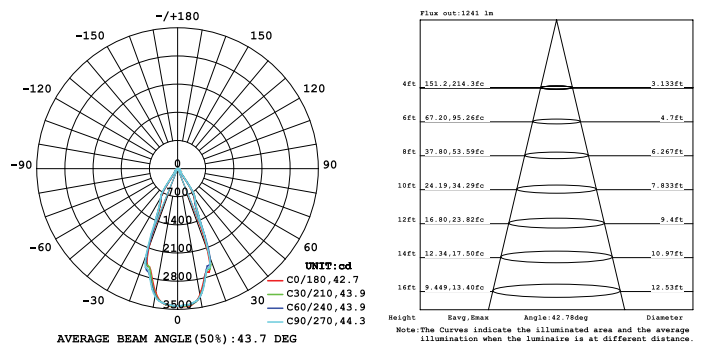

26W WIDE CLEAR-SLIM