

Project:

Lithe 3' 2-Sided Pendant Spec Sheet

SKU: 3463.77

Referencing the industrial elegance of an H beam used in engineering and architecture, Lithe is designed to evenly distribute light in two directions. Lithe Pendants are ideal above any long table, including a kitchen island, a bar, or a conference table. Lithe's driver is in its canopy, making this easy to install for a remodel project. The family includes pendants and [wall lamps](#) in textured black, textured white, and natural anodized finishes.

Learn more: <https://sonnemanlight.com/lithe-2-sided-pendant>

Type #:

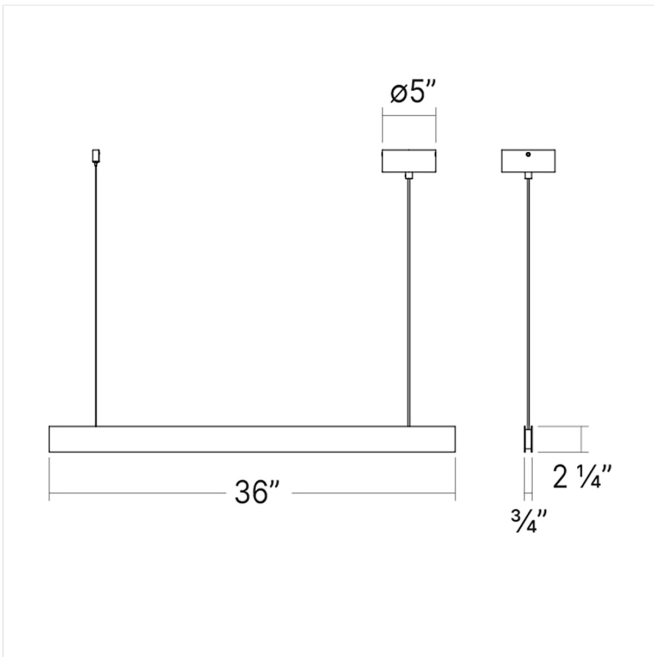

Dimensions

Height:	2.25"
Width:	36"
Length:	0.75"
Depth:	0.75"
Canopy/Backplate/Base:	5"
Hanging Details:	20' Adjustable Cord/Cable
Size:	3'

Electrical Specs

Bulb(s) Included?:	Yes
Bulb 1 Type:	Integral LED
Bulb Quantity:	1
Input Voltage:	120-277VAC
Wattage:	17
Initial Lumens:	2600
Delivered Lumens:	1000
Color Temperature:	3000K
CRI:	90
Power Supply Type:	Driver
Power Supply Quantity:	1
Power Supply Location:	Canopy
Dimming Type:	TRIAC/ELV/0-10V

Installation

Installation:	Licensed electrician required
Sloped Ceiling Compatible?:	Adapter Available
Installation Orientation:	N/A
Minimum Hanging Height:	5"
Maximum Hanging Height:	245"

Shade

Shade Material:	Aluminum
-----------------	----------

General Listings

Features:	Damp Rated
Certification:	C-ETL-US
Color/Finish:	Natural Anodized (.77)

Available Finishes

Available Finishes:	Natural Anodized (.77), Textured Black (.97), Textured White (.98)
---------------------	---

Available Color Temperatures

Available Color Temperatures:	3000k
-------------------------------	-------