

## CHARLIE LED 15W BLACK CEILING MOUNT



### PRODUCT DETAILS

No.	:	35456-XX-01-CN
Product Material	:	Die cast aluminium
Product Color	:	Black
Length	:	5.36"
Diameter	:	2.52"
Height	:	4.84"
Weight	:	2.5lb

### LIGHT SOURCE DETAILS

Light Source Type	:	Integrated LED
Input Voltage	:	120V
Wattage	:	15W
Kelvin	:	3000K 3500K 4000K
Delivered Lumens	:	947lm 952lm 976lm
CRI	:	90+

### OPTIONS AVAILABLE

ITEM NO.	CCT	FINISH
35456-30-01-CN	3000K	BLACK
35456-35-01-CN	3500K	BLACK
35456-40-01-CN	4000K	BLACK

### TECHNICAL DETAILS

Mounting	:	Mounts Over Standard Octagon Box
Canopy Diameter	:	4.72"
Beam Angle	:	30°
Adjustability	:	Up to 90° Vert.   350°Horz.
Dimmable	:	Triac Dimming
Certification	:	
Warranty	:	5 Years

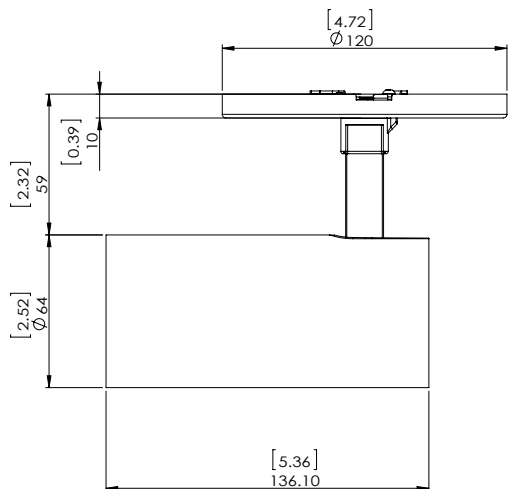

### PROJECT INFORMATION

Job Name:  Date:  Type:

Comments: