

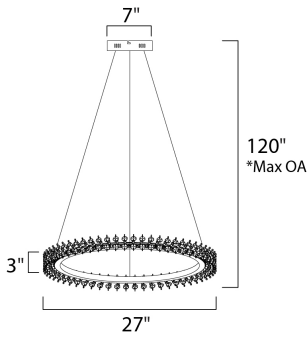

PRODUCT DESCRIPTION

Rings of Polished Chrome are fitted with an array of Beveled Crystal accents that come to life when illuminated by LED strips. The rings can be adjusted to create a spectacular display, sure to bring compliments to sense of style and taste.



*max overall height

MEASUREMENTS

DIMENSION : 27" L x 27" W x 3" H
 MAX OAH : 120" OAH
 CANOPY : 7" W x 1.5" H x 7" L
 HANGING WEIGHT : 8.58 lb

LAMPING

INPUT VOLTAGE : 120V
 LUMENS : 1,540 Rated
 BULB : 1 x 22W LED PCB Integrated , 22W Total
 BULB INCLUDED : (Integrated)
 DIMMABLE : Triac CL
 CRI : 90+ CRI
 COLOR_TEMP : 4000K

FINISHES OPTION



GLASS

Crystal 20

MATERIAL

Stainless Steel

RATINGS

cETLus
 Dry Location



ADDITIONAL

ADJUSTABLE
 OPERATING TEMPERATURE:
 -20°C (-4°F), 40°C (104°F)

Always consult a qualified electrician before installing any lighting product.



WESTERN DISTRIBUTION CENTER (HEADQUARTER)
 253 NORTH VINELAND AVE | CITY OF INDUSTRY, CA 91746
EASTERN DISTRIBUTION CENTER
 4200 SHIRLEY DR. | ATLANTA, GA 30336
 P. 626.956.4200 | F. 626.956.4225 | et2online.com