

**Vistosi**



Vetreria Vistosi Srl · Via G. Galilei, 9-9/A-11 · 31021 Mogliano V.to · Treviso · Italy  
P. Iva IT02497840278 · Cap. Soc. € 100.000,00 I.V. · N° R.E.A. TV - 170728  
Cod. Fisc. - R.I. N° 01808840266 · Iscr. Reg. AEE N° IT08010000000170  
Tel. +39 041 5900170 - 041 5903480 · Fax +39 041 5900992 - 041 5904540  
vetreriavistosi@legalmail.it · www.vistosi.it · vistosi@vistosi.it



AZIENDA CERTIFICATA UNI EN ISO 9001:2000

# PUPPET SP L6 UL

(Rev 00)

# Vistosi

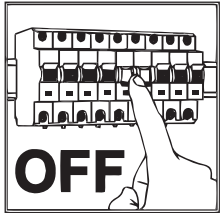

## OUTLET BOX



x6

N F  
(W) (B)



F = FASE  
(B) = BLACK

N = NEUTRAL  
(W) = WHITE

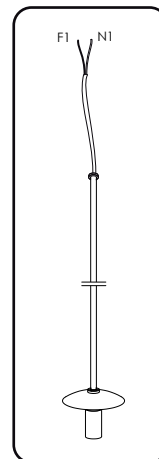
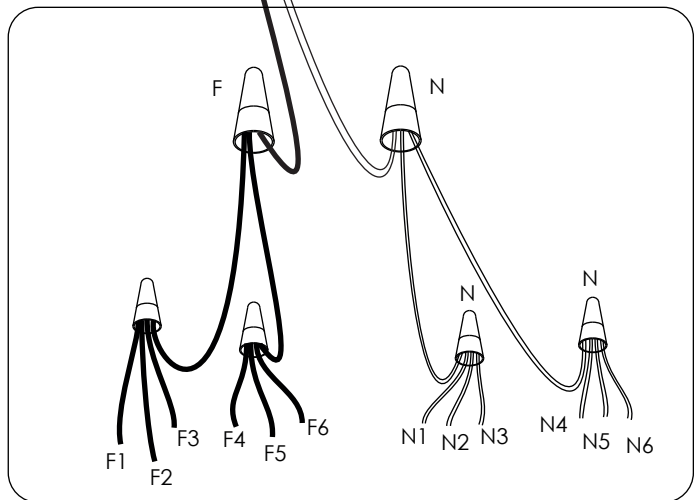
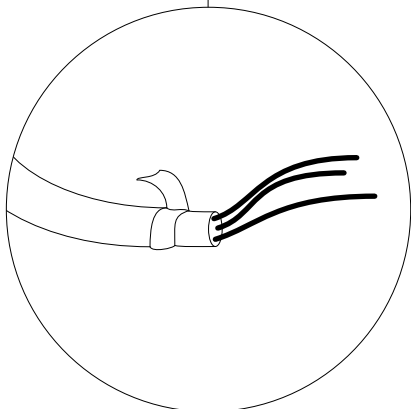
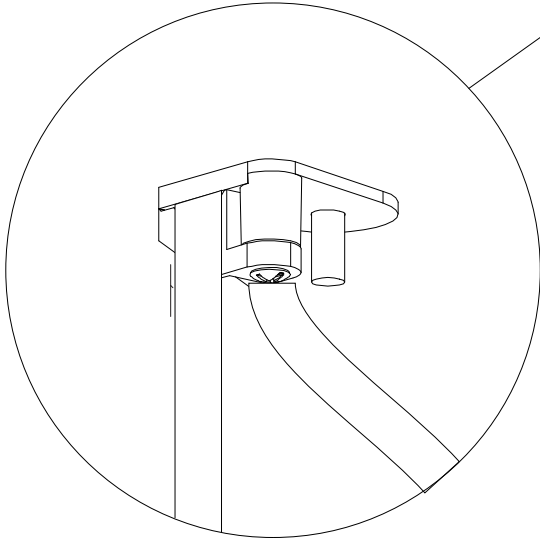
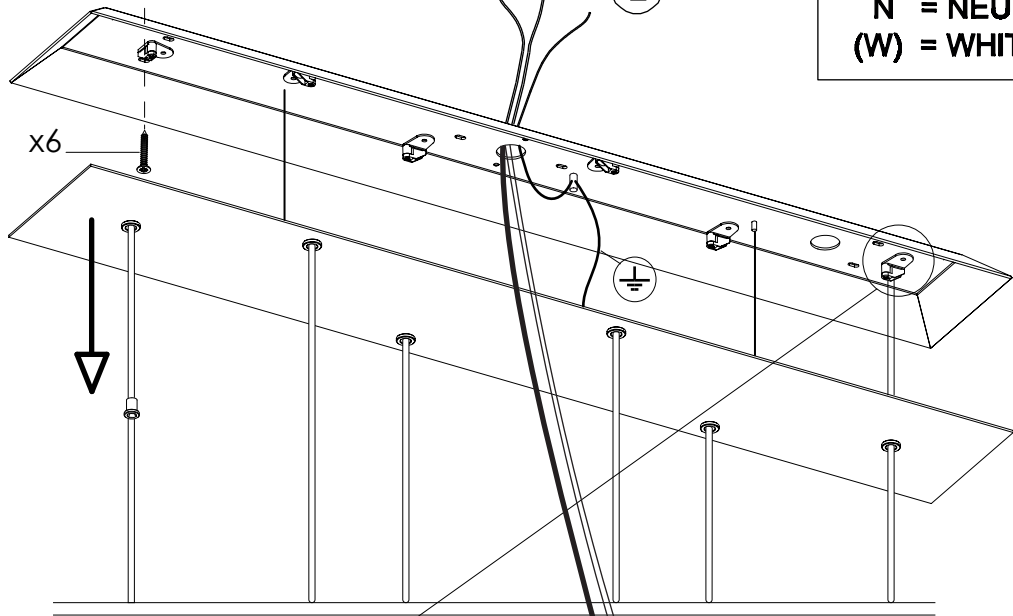

X6

**PUPPET SP L6 UL**

(Rev 00)

Vistosi

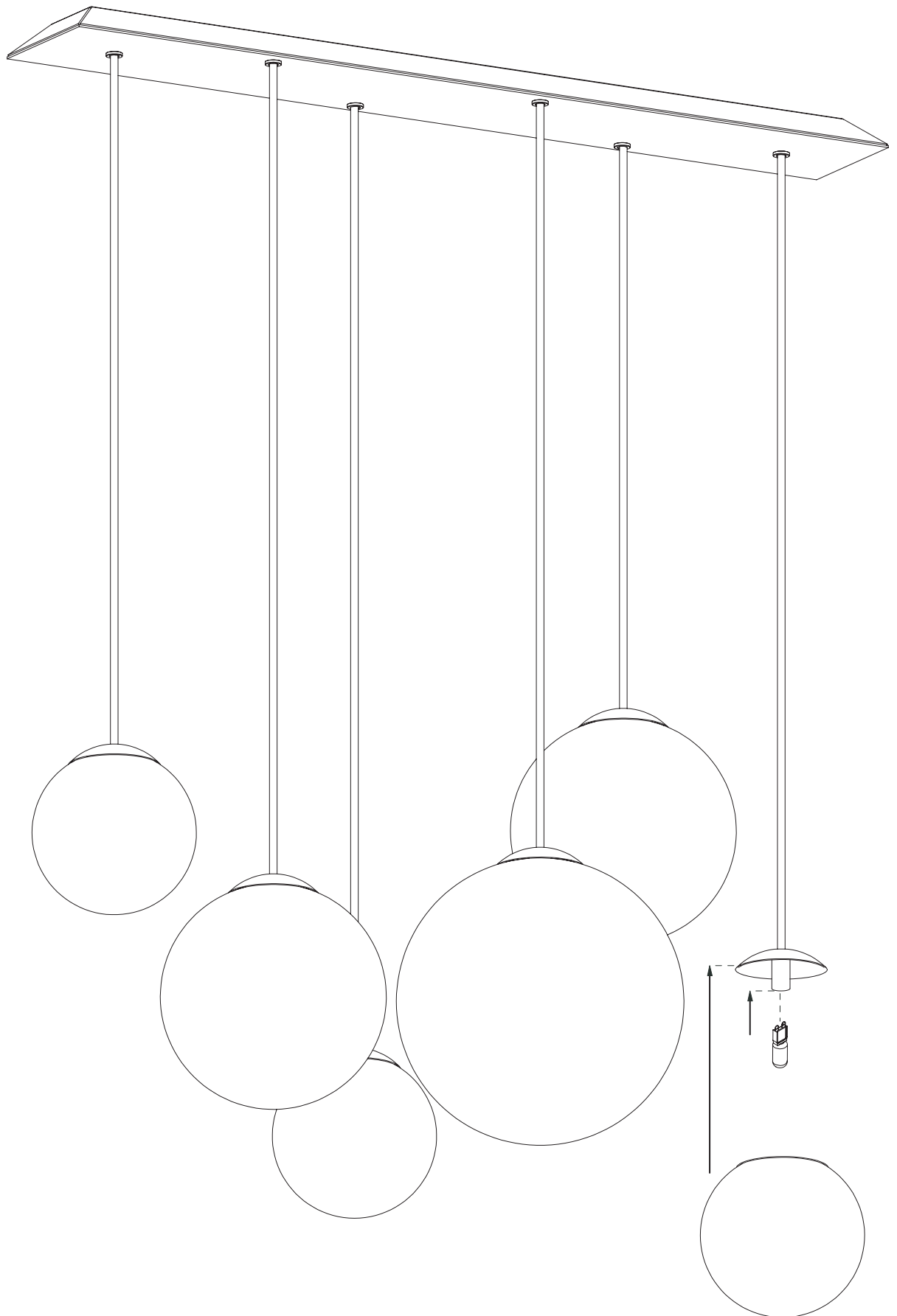



**Configurazione sospensioni /**  
Pendants configuration

