

SETUP SUSPENSION LAMPS  
MONTAJE LÁMPARAS SUSPENSIÓN

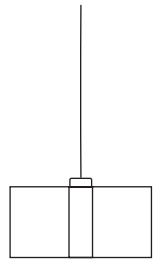
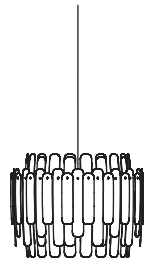
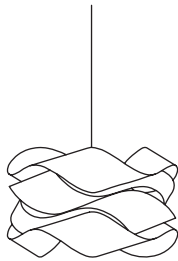
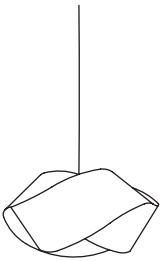
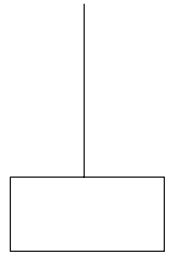
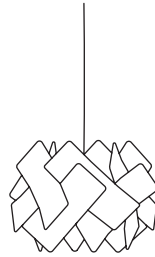
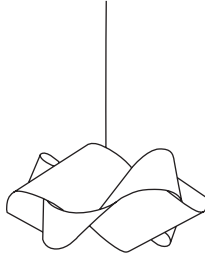

**LZF**

SWIRL, ESCAPE, GEA, NUT, LINK, MARUJA, SUSHI

## A E27

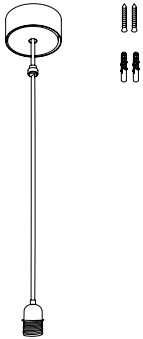

**Contents**  
 1 x Shade  
 1 x Canopy  
 1 x Electrical Cable & Lampholder  
 2 x Screws & wall plugs

**Contenido**  
 1 x Pantalla  
 1 x Florón  
 1 x Cable eléctrico y portalámparas  
 2 x Tornillos y tacos

220 - 250V

### Recommended Bulbs - Not Included

E27 Lamp Holder  
 LED Globe DIM 1 x 16 W  
 Energy Class A

### Bombillas Recomendadas - No Incluidas

E27 Portalámpara  
 Globo LED DIM 1 x 16 W  
 Clase Energética A

Class I

## B E26 or GU24

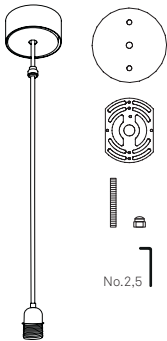

**Contents**  
 1 x Shade  
 1 x Canopy  
 1 x Electrical Cable & Lampholder

**Additional Contents  
 (Only for Junction Box)**  
 1 x Cover  
 1 x Adjustable Back Plate  
 2 x Screws  
 2 x Spherical nuts  
 1 x Allen key N° 2,5

**Contenido**  
 1 x Pantalla  
 1 x Florón  
 1 x Cable eléctrico y portalámparas

**Additional Contents  
 (Sólo para Caja de Conexiones)**  
 1 x Disco circular  
 1 x Placa trasera  
 2 x Espárragos  
 2 x Tuercas Esféricas  
 1 x Llave Allen N° 2,5

120 - 277V

### Recommended Bulbs - Not Included

E26 Lamp Holder  
 LED Globe 1 x 12 W or  
 GU24 Lamp Holder  
 LED A19 1 x 15 W

### Bombillas Recomendadas - No Incluidas

E26 Portalámpara  
 Globo LED 1 x 12 W o  
 GU24 Portalámpara  
 LED A19 1 x 15 W

## C E26 or GU24 with STEEL CABLE

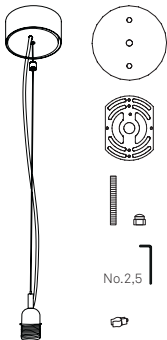

**Contents**  
 1 x Shade  
 1 x Canopy  
 1 x Electrical Cable & Lampholder  
 1 x Steel Cable  
 1 x Clip

**Additional Contents  
 (Only for Junction Box)**  
 1 x Cover  
 1 x Adjustable Back Plate  
 2 x Screws  
 2 x Spherical nuts  
 1 x Allen key N° 2,5

**Contenido**  
 1 x Pantalla  
 1 x Florón  
 1 x Cable eléctrico y portalámparas  
 1 x Cable de acero  
 1 x Clip

**Additional Contents  
 (Sólo para Caja de Conexiones)**  
 1 x Disco circular  
 1 x Placa trasera  
 2 x Espárragos  
 2 x Tuercas Esféricas  
 1 x Llave Allen N° 2,5

120 - 277V

### Recommended Bulbs - Not Included

E26 Lamp Holder  
 LED Globe 1 x 12 W or  
 GU24 Lamp Holder  
 LED A19 1 x 15 W

### Bombillas Recomendadas - No Incluidas

E26 Portalámpara  
 Globo LED 1 x 12 W o  
 GU24 Portalámpara  
 LED A19 1 x 15 W

**1** WARNING ADVERTENCIA

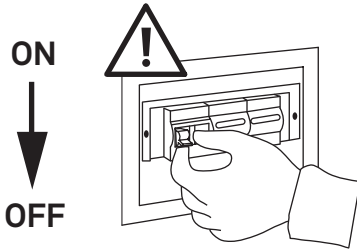

**Before assembly and installing this product, carefully read the following:**

Turn off the mains before installing the lamp. Dry location only. This lamp is for indoor use only.

**Antes de montar e instalar este producto lea atentamente:**

Desconectar la red eléctrica antes de instalar la luminaria. Ubicar en lugares secos. Luminaria para uso exclusivo en interior.

**2** OPEN CANOPY ABRIR FLORÓN

- A** **B** E27, E26 & GU24    **C** E26 & GU24 STEEL CABLE

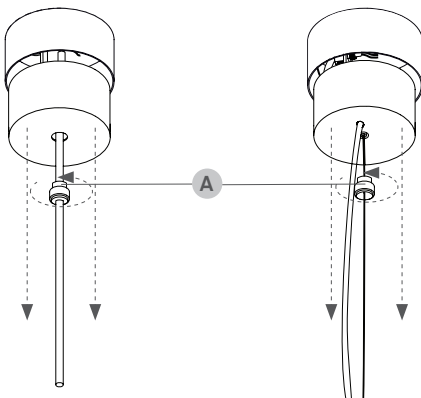

The canopy is made up of two metallic cups, one fitting inside the other. To open the canopy unscrew the canopy support nut (A) and separate the two parts.

El florón está compuesto por una tapa exterior donde se aloja la parte eléctrica y un contraflorón, que sirve para cerrar, desenrosque la tuerca (A) para separarlas.

**3** FIX TO THE CEILING FIJAR AL TECHO

220 - 250V

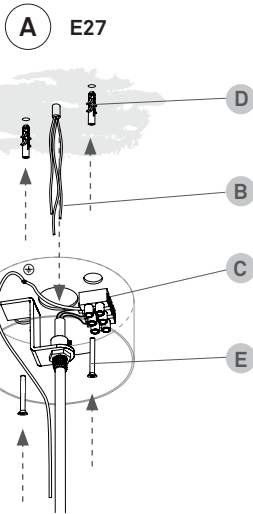

**If you have purchased a lamp with an E27 lampholder:**

Feed the electrical wires (B) from the mains through the canopy (C), fix to the ceiling with the screws (D) and wall plugs (E) and prepare to wire up.

**Si ha adquirido una lámpara E27 :**

Pasar los cables eléctricos (B) a través del florón (C), fijar al techo con los tacos (D) y tornillos (E) para posteriormente conectar.

120 - 277V

**B** E26 & GU24

**C** E26 & GU24 STEEL CABLE

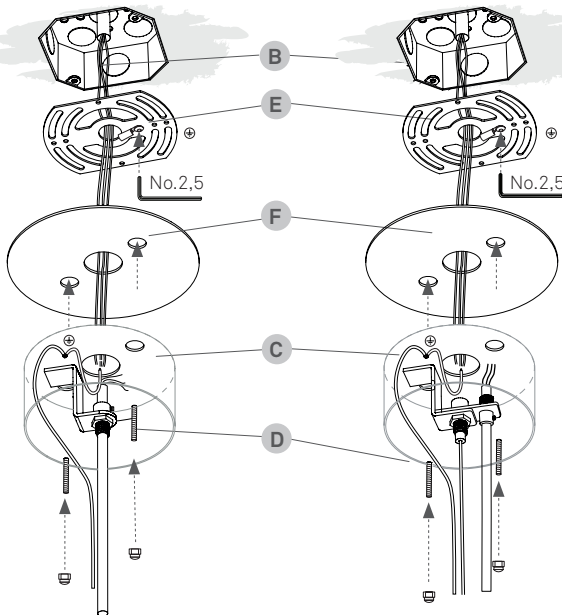

**If you have purchased a lamp with an E26 or GU24 lampholder and without STEEL CABLE:**

Feed the electrical wires (B) from the mains through the adjustable Jbox plate (E) and fix it to the JBox.

Now pass the wires through the cover (F), and the canopy (C).

Fix (F) & (C) to the junction box using the screws (D) and prepare to wire up.

**Si ha adquirido una lámpara con portalámparas E26 o GU24 con o sin CABLE DE ACERO:**

Pasar los cables eléctricos (B) a través de la placa trasera (E) (opcional), del disco circular (F) (opcional) y del florón (C). Fijar las tres piezas a la caja de conexiones para posteriormente conectar.

Si no se tiene caja de conexiones, fijar (D) el florón al techo.

**4** ADJUST THE HEIGHT AJUSTAR ALTURA

**C** E26 & GU24 STEEL CABLE

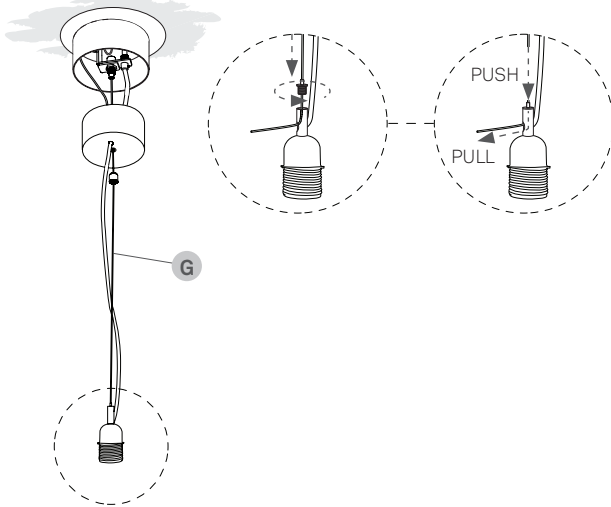

Perform this step only if you have purchased a lamp with an E26 or GU24 lampholder with STEEL CABLE:

Adjust the height of your lamp by raising or lowering the stainless steel adjustment cable (G).

Realice este paso sólo si ha adquirido una lámpara con portalámparas E26 o GU24 con CABLE DE ACERO:

Ajustar la altura de la pantalla subiendo o bajando el cable de acero (G).

**5** CONNECTION CONEXIÓN

MAINS CABLE E27

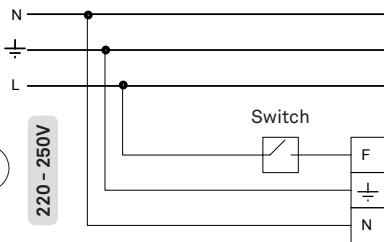

Turn off the mains before installing the lamp.

Connect the lamp to the mains as follows.

You should have a three wire cable coming from the mains, **N, L** and **GND** (⊕).

Connect these to the cables of the same colour coming from the lamp.

Desconectar la red eléctrica antes de instalar la luminaria.

Conecte la lámpara de la siguiente manera.

Debería tener tres cables viniendo de la red, **N, L** and **GND** (⊕).

Conectelos al mismo color en la regleta de conexiones ubicada en el florón.

MAINS CABLE E26 & GU24

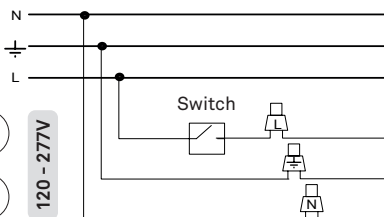

**6** ELECTRICAL CABLE TRAP PRENSACABLE

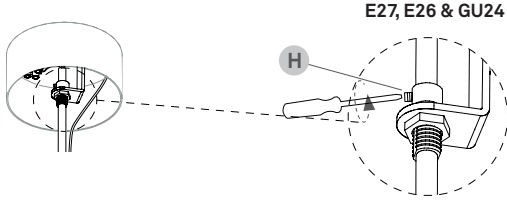

E27, E26 & GU24

Tighten the screw on the electrical cable trap (H).

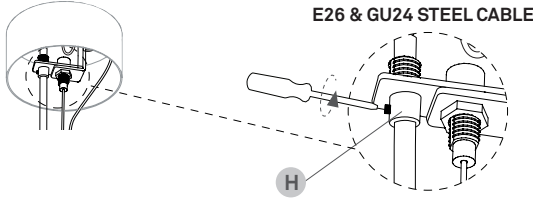

E26 & GU24 STEEL CABLE

Apriete el tornillo del prensacable (H), que encontrará en el interior del florón.

**7** CLOSE CANOPY CERRAR FLORÓN

E27, E26 & GU24

E26 & GU24 STEEL CABLE

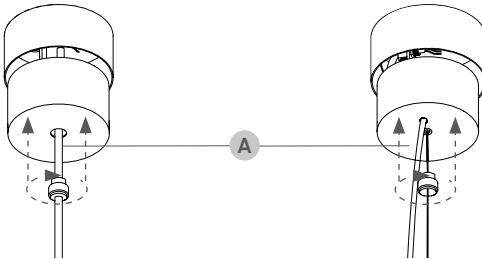

Once all your wiring is complete raise the canopy and screw on the canopy support nut (A) that holds the cover in place.

Una vez conectados todos los cables, suba el contraflorón y fíjelo enroscando la tuerca (A).

**8.1** CABLE CLIP CLIP

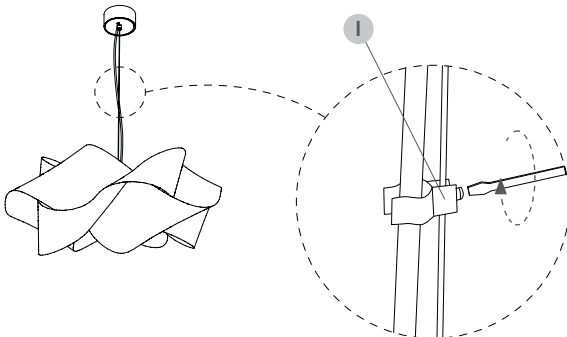

**Perform this step only if you have purchased a lamps with an E26 or GU24 lampholder with STEEL CABLE .:**

Put on the cable clip (I) and clip it to the electrical cable.

**Realice este paso sólo si ha adquirido una lámpara con portalámparas E26 o GU24 con CABLE DE ACERO:**

Colocar el clip (I) en el cable eléctrico y fijar.

**8.2** CUT OF EXCESS CORTAR EL EXCESO

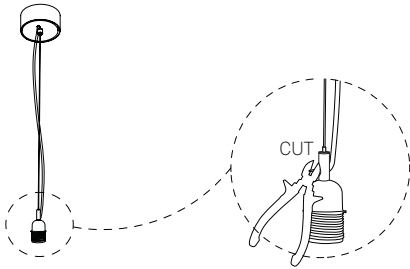

Cut off excess stainless steel cable.

Note: Do not cut off the excess until you are sure of the height of your lamp.

Cortar el exceso del cable de acero.

Nota: No cortes el exceso de cable hasta que no estés seguro de la altura de tu lámpara.

**9** SHADE MOUNT MONTAJE DE PANTALLA

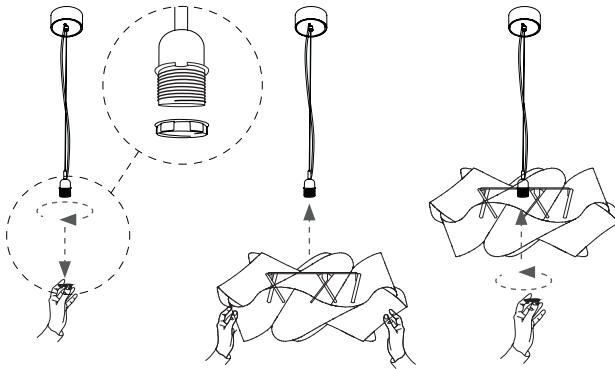

Shade mount.

(example of the SWIRL model in the drawing)

Montaje de la pantalla.

(ejemplo del modelo SWIRL en el dibujo)

**10** INSTALL THE BULB  
INSTALAR BOMBILLA

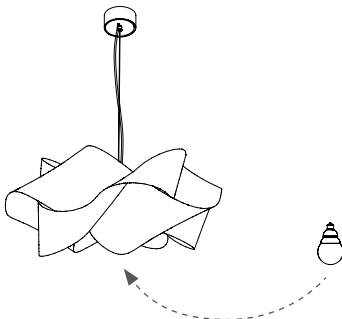

**11** TURN ON THE MAINS  
CONECTAR LA TENSIÓN ELÉCTRICA

ON  
↑  
OFF

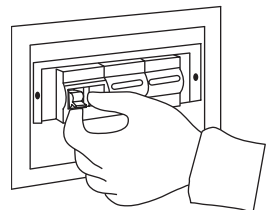

# ASSEMBLY INSTRUCTIONS INSTRUCCIONES DE MONTAJE

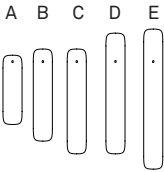

x20 x10 x10 x10 x10

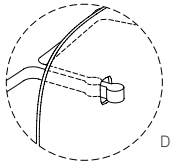

Det. 1

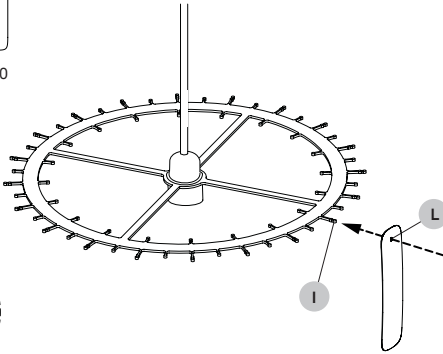

Maruja is made up of 60 pre-cut strips of wood (A, B, C, D, E).

Take the strips and insert them onto the corresponding pins on the metal frame (I) through the hole (L).

NOTE: Each pin has two bumps on them, The wood strip must be inserted between these two bumps in order to create an even distance between the layers of strips. Det 1.

The strips should be mounted in the following order.

Maruja se compone de 60 láminas de madera precortadas (A, B, C, D, E).

en los pasadores correspondientes del marco de metal (I) a través del agujero (L).

NOTA: La lámina de madera debe insertarse entre los dos salientes del pasador. Det 1.

Las láminas deben colocarse siguiendo este orden.

Sheets E

Láminas E

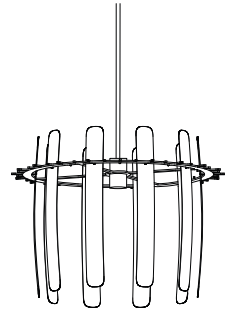
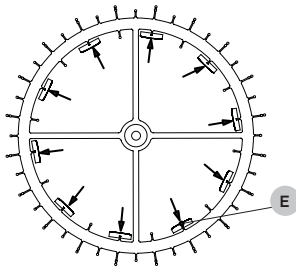

Sheets D

Láminas D

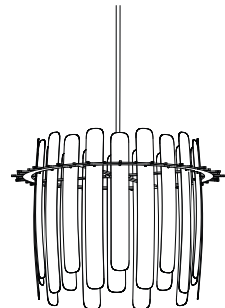
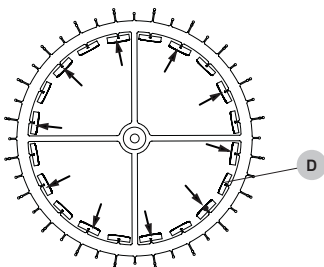
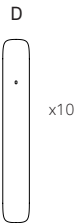



# ASSEMBLY INSTRUCTIONS INSTRUCCIONES DE MONTAJE

Sheets C  
Láminas C

C



x10

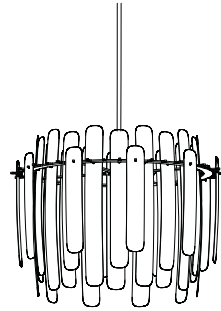
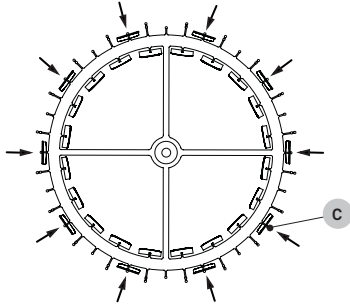

Sheets B  
Láminas B

B



x10

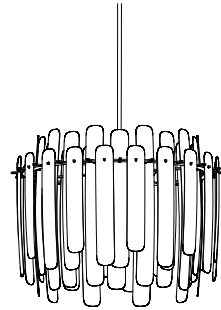
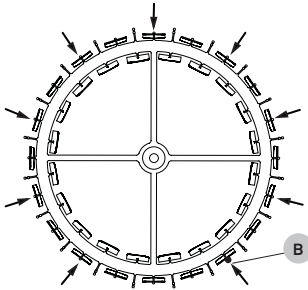

Sheets A  
Láminas A

A

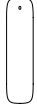

x20

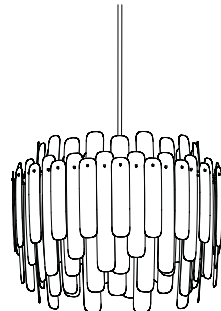
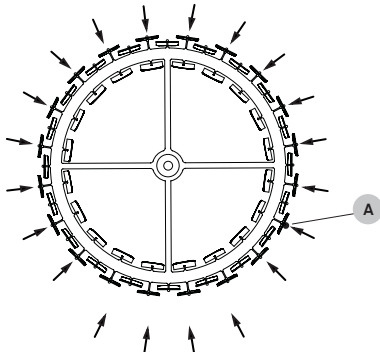

**Use and care of your lamp.**

You have just purchased an original handmade product by LZF. Your lamp is made out FSC® certified natural wood veneer treated with our patented Timberlite® finish. This treatment both protects and safeguards the wood veneer against breakages.

**CLEANING OF ...**

The **shades** we recommended a feather duster or a damp cloth, clean only the flat surface of the veneer with the cloth, and please avoid any moisture contact along the edge of the veneer.

The **metallic surfaces** should be treated with care and cleaned with a soft damp cloth only. Make sure that moisture does not penetrate joints or junctions between metal parts. Do not use solvents of any kind.

The **acrylic diffusers** on your lamp can be cleaned with a regular window cleaning spray and a soft cloth. Do not use solvents of any kind.

**PRECAUTIONS****Luminaire for indoor use only.**

Unplug the lamp before cleaning. Servicing or manipulation of the electrical installation should only be performed by qualified electrical personnel or by the LZF service department.

**Glass**

Improper handling can cause loosening or chipping of the glass. Any bubbles, or lack of homogeneity in the glass is a characteristic feature of hand blown glass and not a defect. The surface of the glass may also include imperfections due to its manual manufacturing. When cleaning, use a window cleaning spray and a soft cloth.

Avoid handling glass without gloves to prevent fingerprints and loss of gloss.

**Wood veneer**

Avoid direct sunlight, strong indirect sunlight and moisture on your lamp. Since wood is a natural material, a gradual change in tone may occur over time. Furthermore, if the lamps were purchased at different times, there will be differences in colour and tone, particularly in lighter coloured veneers. This is can not be considered a manufacturing defect or reason for complaint. Do not install your lamp near any air-conditioning vents or ventilation shafts as this may damage the wood veneer used in this fixture.

**LEDS**

If your lamps contains Integrated LED circuits do not touch the LED surface with your bare hands as this can reduce the life of your LED.

**BULBS**

Bulbs are normally not included, unless indicated. We recommend using energy-saving LED bulbs. Please refer to the instruction manual or visit our website [www.lzf-lamps.com](http://www.lzf-lamps.com) to make sure you are using the best bulb for your type of lamp.

**KELVINS**

Depending on the color of the wood veneer we recommend using different Kelvin light temperatures, for their optimum appearance: Blue 28, Turquoise 30 and Grey 29: 4000k  
Ivory White 20, Natural Beech 22, and Natural Cherry 21: 3000 or 4000k.  
Yellow 24, Orange 25, Red 26, Chocolate 31 & Pale Rose 33: 3000k.

Learn more about Kelvins.

**Uso y cuidado de su lámpara**

Acaba de adquirir un producto original y hecho a mano por LZF. Su lámpara está fabricada con chapa de madera natural certificada FSC® tratada con nuestro acabado patentado Timberlite®. Este tratamiento protege la madera, a la vez que evita posibles roturas.

**LIMPIEZA DE ...**

**La madera**, recomendamos usar un plumero o un paño húmedo, evitando incidir en los cantos de la chapa.

**Las superficies metálicas** deben tratarse con cuidado y limpiarse únicamente con un paño suave y húmedo. Asegúrese de que la humedad no penetre en las uniones de las partes metálicas. No use disolventes de ningún tipo.

**Los difusores acrílicos** se pueden limpiar con un líquido limpia cristales y un paño suave. No usar disolventes de ningún tipo.

**PRECAUCIONES****Luminaria para uso exclusivo en interior.**

Desenchufar la lámpara antes de cambiar la bombilla o limpiarla. La manipulación de la instalación eléctrica debe efectuarse solo por personal cualificado o por LZF.

**Vidrio**

Un manejo inadecuado puede provocar que el vidrio se afloje o se astille. Cualquier burbuja, o falta de homogeneidad en el vidrio no es motivo de queja, este es un rasgo característico del vidrio soplado a mano.

La superficie del vidrio también puede presentar imperfecciones debido a su fabricación manual. Al limpiar, use un spray limpiacristales y un paño suave.

No manipule el vidrio sin guantes para evitar huellas dactilares y pérdida de brillo.

**Madera**

Evitar el sol directo o la luz intensa indirecta del sol y la humedad sobre la lámpara. Debido a que la madera es un material natural, pueden existir variaciones en el tono de ésta. Si las lámparas se adquieren en diferentes periodos de tiempo, pueden mostrar variaciones de color y tono sobre todo en las maderas de tonos claros. No situar la lámpara próxima a una salida de aire debido a que éste puede ocasionar daños en la misma. Luziferlamps S.L. no se hará responsable.

**LEDS**

Si su lámpara contiene LED integrado. No tocar nunca con las manos desnudas, ya que esto puede reducir la vida útil de su LED.

**BOMBILLAS**

Las bombillas no están incluidas, a menos que se indique. Recomendamos utilizar bombillas de bajo consumo LED. Consulte el manual de instrucciones o visite nuestro sitio web [www.lzf-lamps.com](http://www.lzf-lamps.com) para asegurarse de que está utilizando la mejor bombilla para su tipo de lámpara.

**KELVINS**

Dependiendo del color de la chapa de madera recomendamos utilizar diferentes temperaturas de luz, para su óptimo aspecto: Azul 28, Turquesa 30 y Gris 29: 4000k.  
Ivory White 20, Natural Beech 22 y Natural Cherry 21: 3000 o 4000k.  
Amarillo 24, Naranja 25, Rojo 26, Chocolate 31 y Rosa Palo 33: 3000k.

Saber más sobre Kelvins.

MÁS INFORMACIÓN: <http://www.lzf-lamps.com/guarantee/>



MORE INFO: <http://www.lzf-lamps.com/guarantee/>

© Luziferlamps, S.L. All rights reserved. Valencia, Spain. 2020 - [www.lzf-lamps.com](http://www.lzf-lamps.com) - [support@lzf-lamps.com](mailto:support@lzf-lamps.com)