

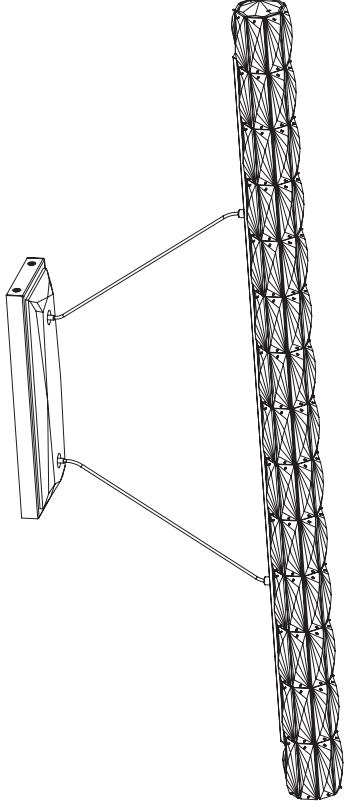









VERVE S2643-\_\_R



THIS DESIGN IS THE PROPRIETARY  
TRADE DRESS/TRADENAME OF  
SCHONBEK LLC.

SCHONBEK  
*Signature*<sup>TM</sup>

							
S2643.42W		120-277V					

WWW.SCHONBEK.COM/INSTALLATIONMANUAL

SCHONBEK  
*Signature*<sup>TM</sup>

All electrical components must be installed by a licensed electrician in accordance with the National Electric Code and the appropriate local electrical codes.

