

Ampoule non incluse
Bulb not included

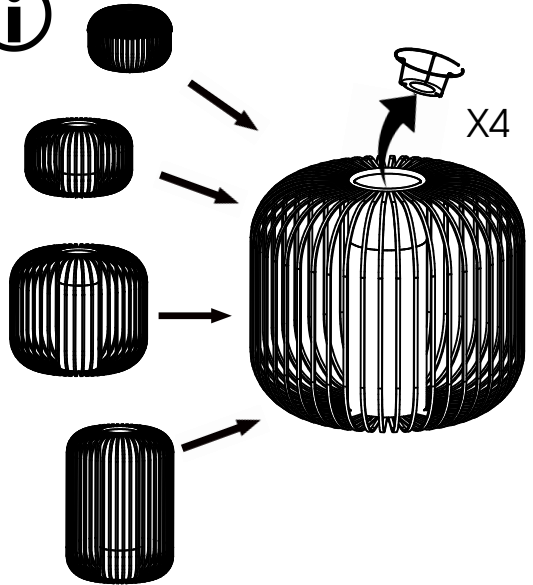
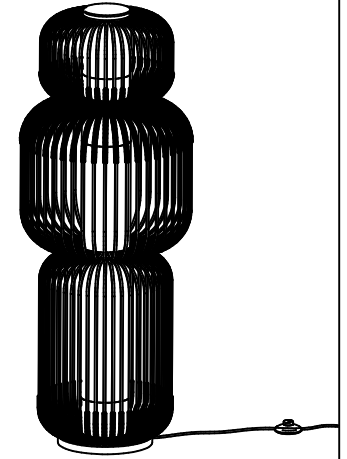

Sur votre produit, le symbole de la poubelle barrée d'une croix, indique qu'il est soumis à la directive européenne 2012/19/UE: les produits électriques, électroniques, les batteries et accumulateurs doivent impérativement faire l'objet d'un tri sélectif. Veuillez à déposer votre produit hors d'usage dans une poubelle appropriée, ou le restituer dans un point de collecte. Les collectivités ou les revendeurs vous communiquerons toutes les informations essentielles concernant l'élimination de votre ancien produit. Ne pas mettre votre ancien produit au rebut avec vos déchets ménagers permet de protéger l'environnement et la santé.

(D) WENN DAS FLEXIBLE AUSSENKABEL ODER DIE SCHNUR DIESER BELEUCHTUNG BESCHÄDIGT WIRD, MUß VOM HERSTELLER, SEINEM WARTUNGSDIENST ODER JEDER ENTSPRECHENDEN QUALIFIKATIONSPERSON DIES AUSSCHLIEßLICH HERSETZT WERDEN, UM JEDES RISIKO ZU VERMEIDEN

(P) SE O CABO EXTERNO FLEXÍVEL OU O CABO DESTA LÂMPADA FOREM DANIFICADOS, DEVE SER SUBSTITUÍDO PELO FABRICANTE, POR SEU SERVIÇO DE MANUTENÇÃO OU POR TODA A PESSOA DA QUALIFICAÇÃO EQUIVALENTE PARA EVITAR QUALQUER RISCO

(NL) ALS DE SOEPELE BUITENLANDSE KABEL OF HET TOUW VAN DIT VERLICHTINGSTOESTEL WORDEN BESCHADIGD, HIJ MOET DOOR DE FABRIKANT VERVANGEN WORDEN, ZIJN DIENST VAN ONDERHOUD OF IEDERE PERSOON VAN GELIJKWAARDIGE KWALIFICATIE, DIT TENEINDE ELK RISICO TE VERMIDEN.

(GK) Εάν το εύκαμπτο εξωτερικό καλώδιο ή το σκοινί αυτού του λαμπτήρα είναι χαλασμένο, πρέπει να αντικατασταθεί από τον κατασκευαστή, ή υπηρεσία συντήρησης του ή οποιοδήποτε πρόσωπο των ισοδύναμων προσόντων, αυτό για να αποφευχθεί οποιοδήποτε κίνδυνο

(FR) SI LE CÂBLE EXTÉRIEUR SOUPLE OU LE CORDON DE CE LUMINAIRE EST ENDOMMAGÉ, IL DOIT ÊTRE REMPLACÉ PAR LE FABRICANT, SON SERVICE DE MAINTENANCE OU TOUTE PERSONNE DE QUALIFICATION ÉQUIVALENTE, CECI AFIN D'ÉVITER TOUT RISQUE.

(GB) IF THE FLEXIBLE EXTERNAL CABLE OR THE CORD OF THIS LAMP IS DAMAGED, IT MUST BE REPLACED BY THE MANUFACTURER, HIS SERVICE OF MAINTENANCE OR ANY PERSON OF EQUIVALENT QUALIFICATION, THIS TO AVOID ANY RISK

(ES) SI EL CABLE EXTERNO FLEXIBLE O LA CUERDA DE ESTA LÁMPARA SE DAÑA, DEBE SER SUBSTITUIDA POR EL FABRICANTE, SU SERVICIO DE MANTENIMIENTO O CUALQUIERA PERSONA DE CALIFICACIÓN EQUIVALENTE PARA EVITAR CUALQUIER RIESGO

(IT) SE IL CAVO ESTERNO FLESSIBILE O IL CAVO DI QUESTA LAMPADA È DANNEGGIATO, DEVE ESSERE SOSTITUITO DAL FORNITORE, DAL SUO SERVIZIO DI MANUTENZIONE O DA CHIUNQUE DELLA QUALIFICAZIONE EQUIVALENTE PER EVITARE TUTTO IL RISCHIO



Pour utilisation intérieur uniquement
For indoor use only



AL32161
rue Radio-Londres
33130 Begles

forestier
PARIS

1



Ampoule non incluse
Bulb not included

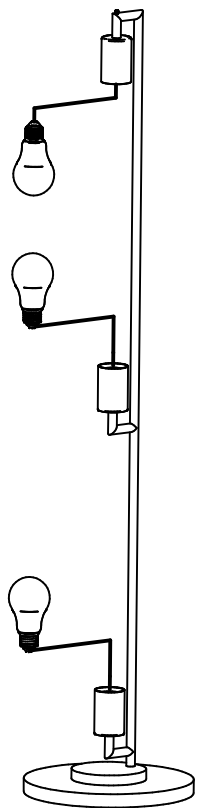

2

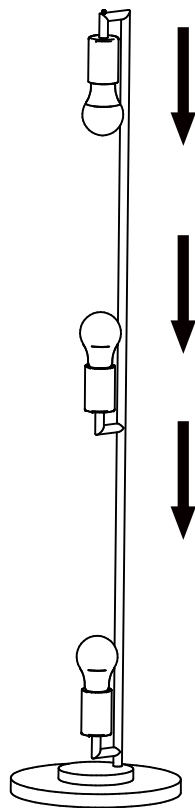
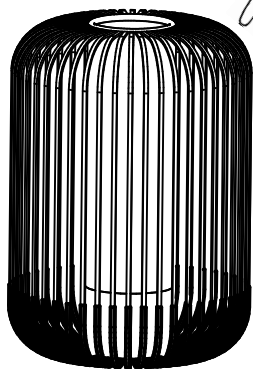

3

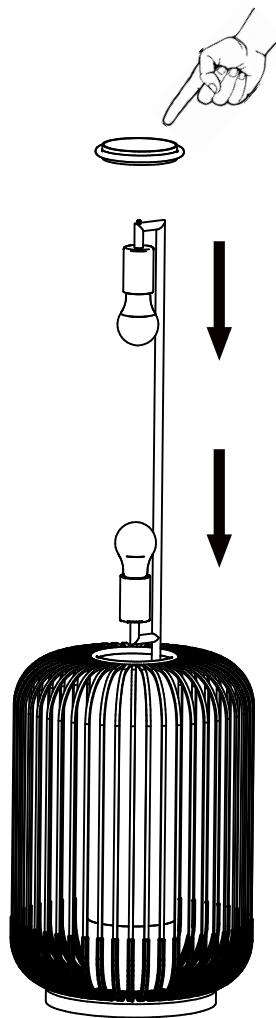

4

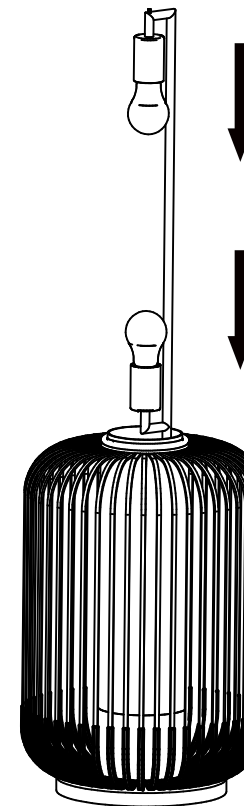
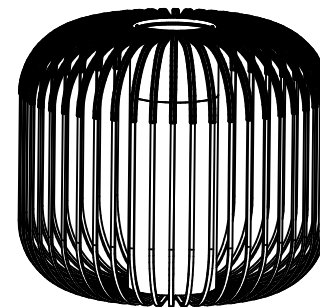

AL32161
rue Radio-Londres
33130 Begles
forestier
PARIS

5

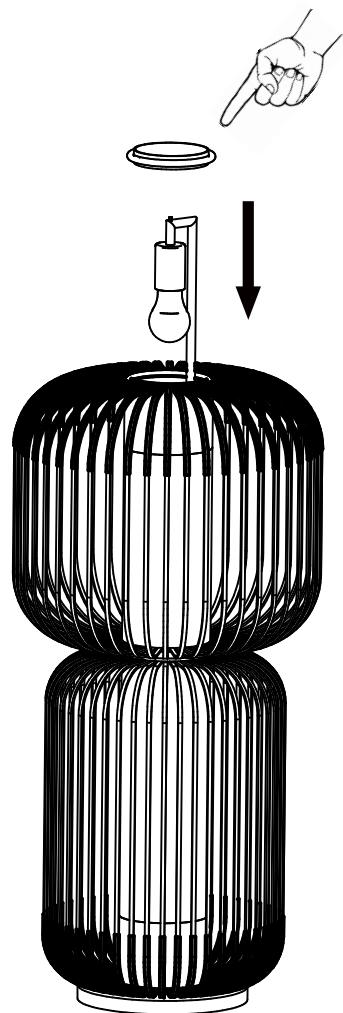

6

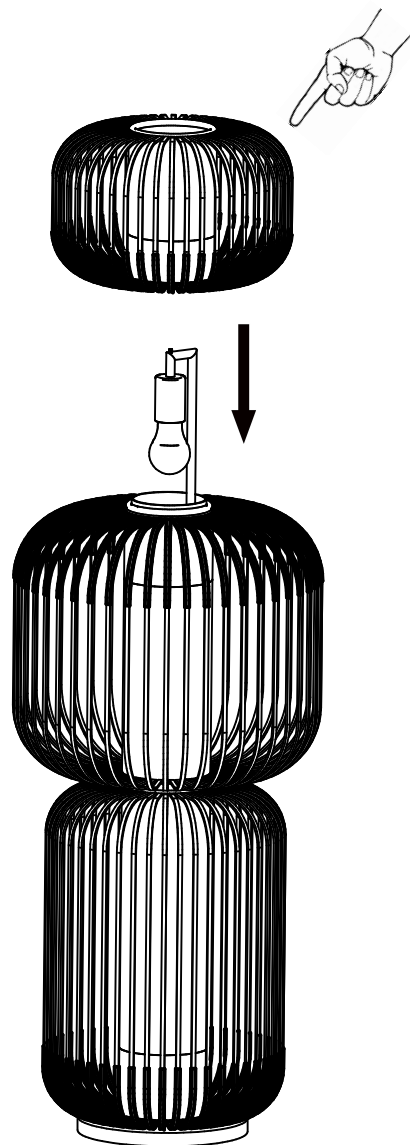

7



8

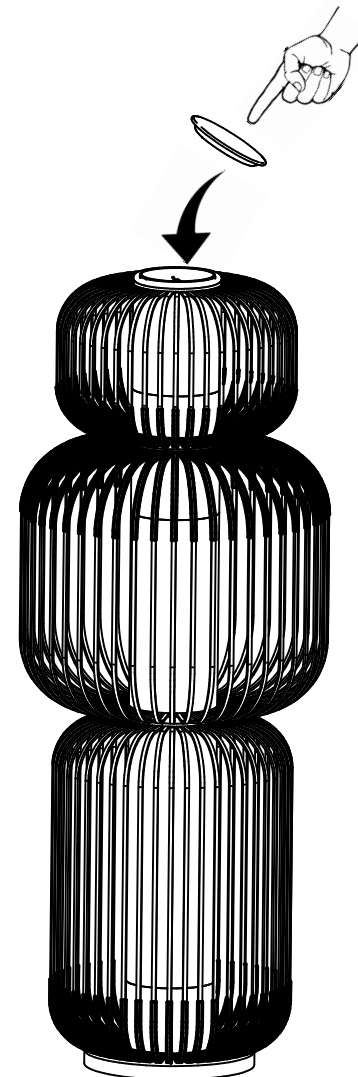

AL32161

rue Radio-Londres
33130 Begles

 **forestier**
PARIS