

## Included Components

- Hardware Packet R, with Instructions
- Glass Gems (QTY:7)
- Canopy
- Braided Fabric Cord (QTY:7)
- Cord grip (QTY:7 — Attached to canopy)
- Set Screws (QTY: 14)
- Cylinder Knobs (QTY:4)

## Required Tools

- Allen Key (provided)
- Philips screw driver (not provided)
- Wire cutters/strippers (not provided)
- Measuring tape (not provided)

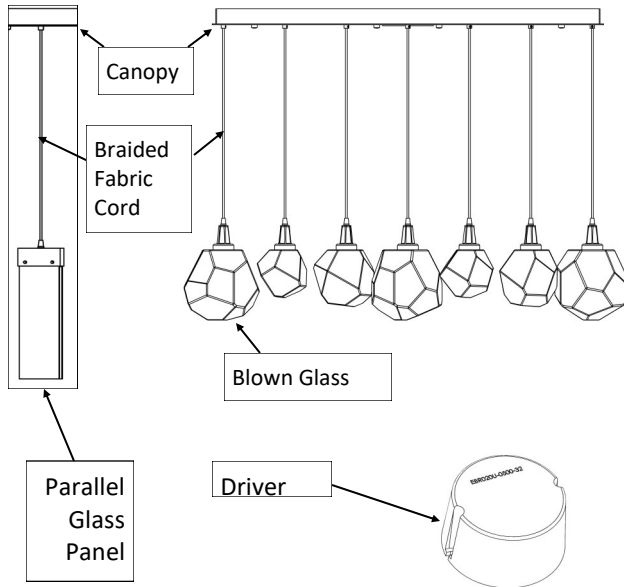

## Assembly Instructions

**Step 1:** Feed the braided fabric cord into the canopy until the desired amount of cord is left between the canopy and light body. Take into account that a minimum of 6" of cord will be required for connecting the wiring to the driver.

**Step 2:** Use the measuring tape to be sure that all of your light body is hanging the proper distance from the canopy. Tighten the cord grip using a flat blade screw driver. The cord grip is on the face of the canopy. **DO NOT OVER TIGHTEN. THIS MAY DAMAGE THE FIXTURE.**

**Step 3:** Make wire connections to each of the drivers, mounted inside of the canopy. Use the two installed terminal blocks make the following connections. Remove protective covers from terminal blocks by removing the two screws from one side. The driver marked **EBR020U-0500-32** will be wired in series with **3** pendants. The driver marked **EBR020U-0500-42** will be wired in series with **4** pendants. Braided fabric cord must be wired to the Driver, **Black to Black and White to Red**. Make wire connections from driver to supply. White to white, black to black, and ground the fixture to the canopy.

### WARNING

**DO NOT DIRECTLY CONNECT LEDs TO AC POWER.** LEDs will be damaged if exposed to high voltages. The LED's must be wired in series to work properly.

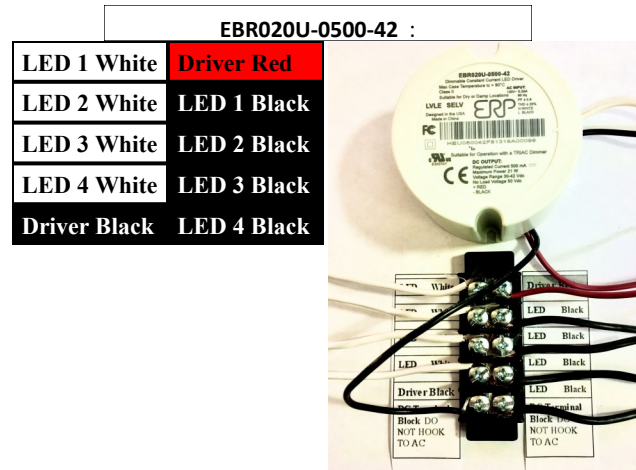

**Step 4:** Mount the canopy to the ceiling using the provided **Mounting Instructions**.

**Step 5:** Attach face plate to canopy using cylinder knobs. Glass should not be installed on cords.

**Step 6:** Attach glass LED pendant housing:

**If Gem, Hedra, Rock Crystal, or Aalto Pendant:**

Use #4-40 flat head screws provided to attach glass to pendant housing.

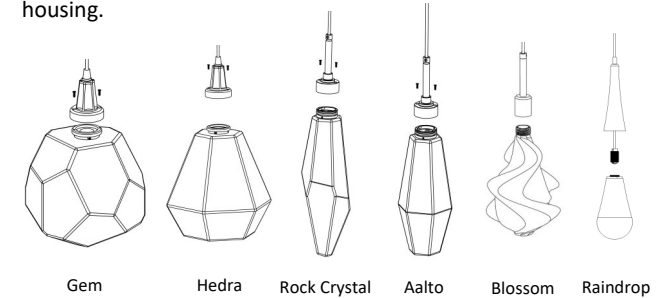

**Ledgestone Pendant:**

Use #8-32 nylon tip set screws to retain blown glass.

**If Axis Pendant:**

Slide glass along retention screws using slot in glass. Slide pendant cover over glass and tighten finial until snug.

**Blossom Pendant:**

Screw glass element into threaded pendant housing

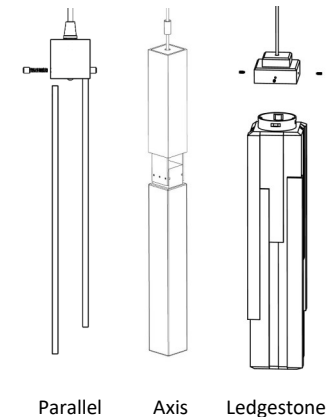

**Parallel Glass Pendant:**

Install glass panels by unscrewing the cylinder knobs until glass can be slid into housing.

Note that the cylinder knobs do not have to be fully removed from the fixture to install glass panels.

Tighten the cylinder knobs, ensuring that the all thread passes through the glass panels.

**If Raindrop Glass Pendant:**

Install blown glass by raising cover to expose the electrical assembly at the end of the braided cord. Place frosted diffuser in glass mount, frosted side down, and screw the glass assembly onto the threaded LED mount. Tighten with wrench. Next, lower cover back over glass and screw to tighten down.

**(NOTE: Tighten cover till Snug. DO NOT Overtighten!)**

### HAMMERTON STUDIO

When we introduced the Hammerton Studio brand in 2014, we saw an enormous opportunity to raise the bar in decorative lighting. In design, we wanted to lead rather than follow. In construction, we wanted to showcase Hammerton's renowned reverence for time-honored artisan craftsmanship and authentic materials. In performance, we wanted to provide highly reliable solutions that far exceeded industry norms for aesthetics, function, and quality. Based on the brand's dramatic growth and customer feedback, it's clear we are on the right track.

### EXTRAORDINARY DESIGN VALUE IN ARTISAN GLASS & METALWORK

Hammerton began in 1995 as a blacksmith shop, but we've come a long way since then. Today we employ a world class team of metal artisans who are disciplined in a broad range of fabrication techniques and processes. We've also added in-house capabilities in blown, cast and kiln-fused glass, and today Hammerton operates one of the largest artisan glass production facilities in the U.S. With deep design and fabrication expertise at the intersection of glass and metalwork, we're laying the foundation for a new era of lighting innovation.

### THE HAMMERTON HERITAGE

Our Hammerton Studio brand stands on the shoulders of more than a quarter century of experience pushing the boundaries of innovative custom lighting design. Each Hammerton Studio collection has been inspired by custom work our company has brought to life in collaboration with leading interior design professionals over the years. Built to your specifications, every fixture reflects the uncompromising design and attention to detail that is distinctly Hammerton.

### A REPUTATION REFLECTED BY OUR CLIENTS

Hammerton fixtures are as extraordinary as the clients who purchase them, including Forbes 400 members, Fortune 500 leaders, award-winning entertainers, fashion and interior designers, sports legends, and leading luxury hospitality brands.

Hammerton Inc.  
217 Wright Brothers Drive  
Salt Lake City, UT 84116

801-973-8095  
info@hammerton.com  
[www.hammerton.com](http://www.hammerton.com)

### ONE YEAR LIMITED WARRANTY

Hammerton, Inc. (Hammerton) warrants the original owner that this product will be free of defects in material or workmanship for the period of one year from the date of original purchase from Hammerton, if (i) the allegedly defective product has not been abused, misused or improperly maintained and or repaired during the warranty period, (ii) the defect is not caused by water damage/flooding, fire, explosion, earthquakes or similar phenomenon, and (iii) the defect is not caused by improper installation (unless installed by Hammerton).

In order to obtain warranty service, the user must first complete a warranty claims form. Hammerton will determine if the product will be inspected on site or returned to Hammerton. If after the inspection Hammerton finds that the product is defective as claimed, Hammerton will, at its option, repair or replace the product free of charge, or Hammerton may also agree to outsource necessary repair work locally using local contracted labor. Prior to any outsourcing of repair work regarding this fixture, a Work Authorization Form must be signed by both the client and Hammerton Representative. Failure to do so may result in a denial of reimbursement. Hammerton warrants any replaced or repaired products for ninety days after shipment or through the end of the original warranty period, whichever is longer. All products or parts that are replaced become the property of Hammerton.

No representative or employee of Hammerton is authorized to make any modification or addition to this limited warranty.

TO THE FULL EXTENT ALLOWED BY LAW, THE FOREGOING WARRANTY AND REMEDIES ARE EXCLUSIVE, AND HAMMERTON EXPRESSLY DISCLAIMS ALL OTHER WARRANTIES, EXPRESSED OR IMPLIED, INCLUDING WITHOUT LIMITATION THE IMPLIED WARRANTIES OF MERCHANTABILITY AND FITNESS FOR A PARTICULAR PURPOSE. TO THE FULL EXTENT ALLOWED BY LAW, HAMMERTON EXCLUDES AND DISCLAIMS LIABILITY, WHETHER BASED IN CONTRACT OR TORT (INCLUDING NEGLIGENCE FOR ANY CONSEQUENTIAL, INDIRECT INCIDENTAL OR SPECIAL DAMAGES OF ANY NATURE ARISING OUT OF THE SALE INSTALLATION, MAINTENANCE, USE OR FAILURE OF THIS PRODUCT, EVEN IF HAMMERTON HAS BEEN ADVISED OF THE POSSIBILITY OF SUCH DAMAGES IN ADVANCE, AND HAMMERTON LIMITS ITS LIABILITY TO REPLACEMENT, REPAIR OR REFUND OF THE PURCHASE PRICE PAID, AT HAMMERTON'S OPTION.)

SOME STATES DO NOT ALLOW LIMITATIONS ON HOW LONG AN IMPLIED WARRANTY LASTS AND/OR DO NOT ALLOW THE EXCLUSION OR LIMITATION OF INCIDENTAL OR CONSEQUENTIAL DAMAGES, SO THE ABOVE LIMITATION ON IMPLIED WARRANTY AND INCIDENTAL OR CONSEQUENTIAL DAMAGES MAY NOT APPLY TO YOU. THIS WARRANTY GIVES YOU SPECIFIC LEGAL RIGHTS YOU MAY HAVE OTHER RIGHTS, WHICH VARY FROM STATE TO STATE

## Assembly Instructions

PLB0039-07, PLB0042-07, PLB0045-07, PLB0049-07, PLB0050-07, PLB0056-07, PL0059-07, PLB0060-07, PLB0078-07

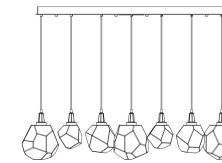

PLB0039-07

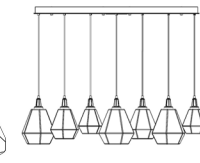

PLB0045-07

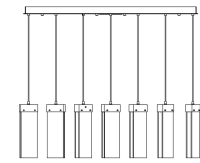

PLB0042-07



PLB0050-07

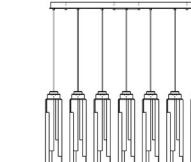

PLB0056-07

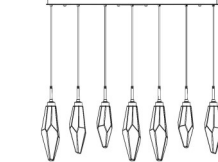

PLB0049-07

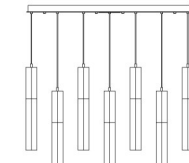

PLB0060-07

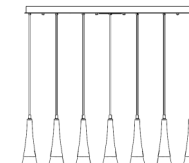

PLB0078-07

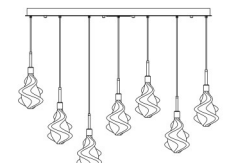

PLB0059-07

**WARNING: FAILURE TO INSTALL THIS FIXTURE PROPERLY MAY RESULT IN SERIOUS PERSONAL INJURY OR DEATH AND PROPERTY DAMAGE.**

It is recommended that this product be installed by a licensed electrician who is familiar with proper LED installation and electrical loads.