

BARONET BN1236N- __ __ O

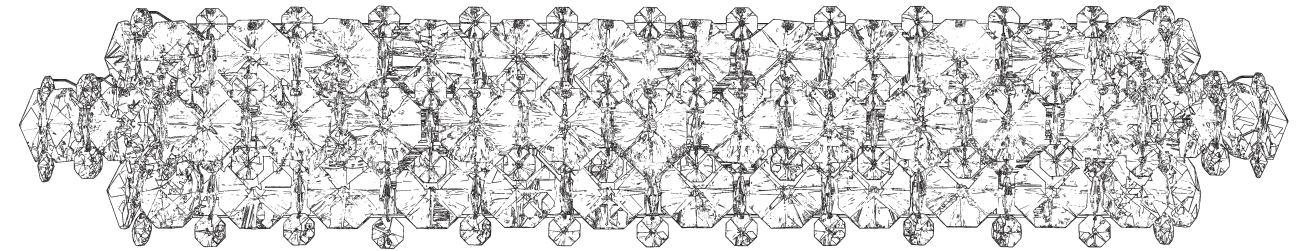

 **SCHONBEK** | 1870

THIS DESIGN IS THE PROPRIETARY
TRADE DRESS/TRADEMARK OF
W SCHONBEK LLC.

7 Lights
Diameter: 35"
Height: 6-1/2"
Extension: 6-1/2"
Hanging Weight: 18lbs.

 **SCHONBEK** | 1870

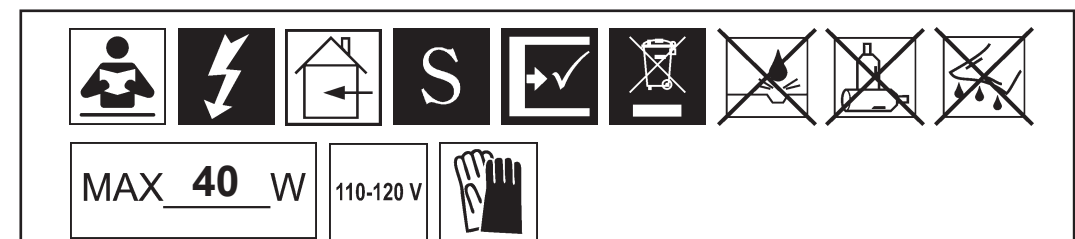

WARNING:

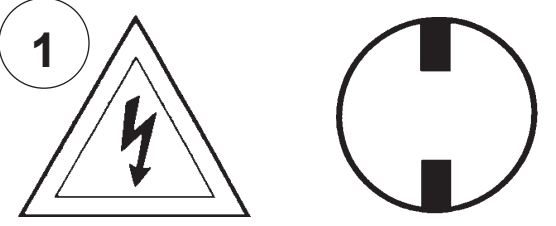
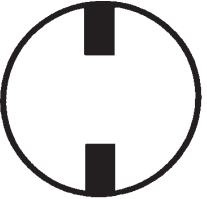
1  

Electrical Danger **Turn Power Off**

All electrical components must be installed by a licensed electrician in accordance with the National Electric Code and the appropriate local electrical codes.

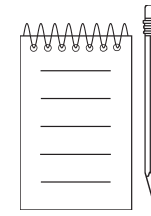
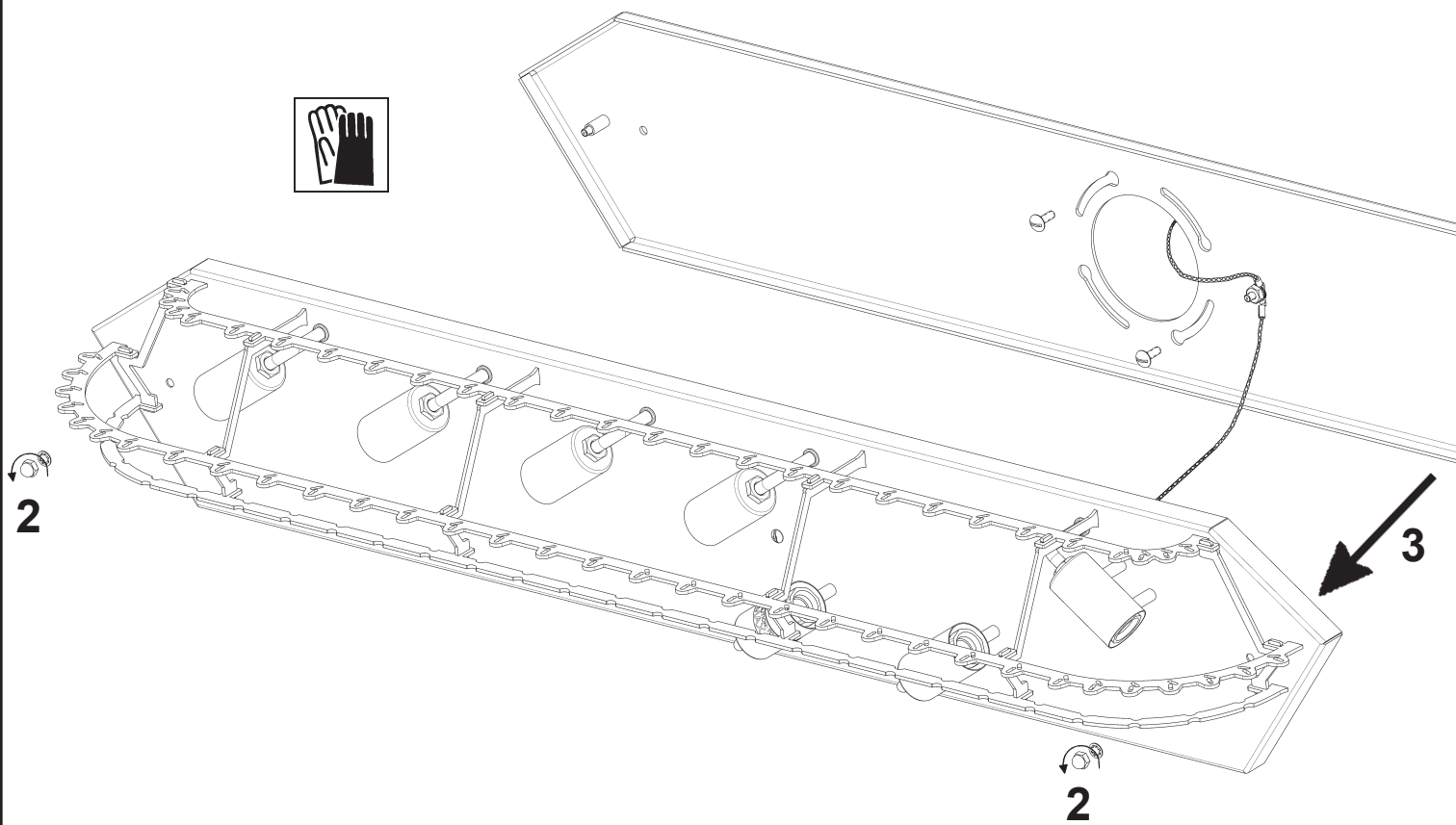

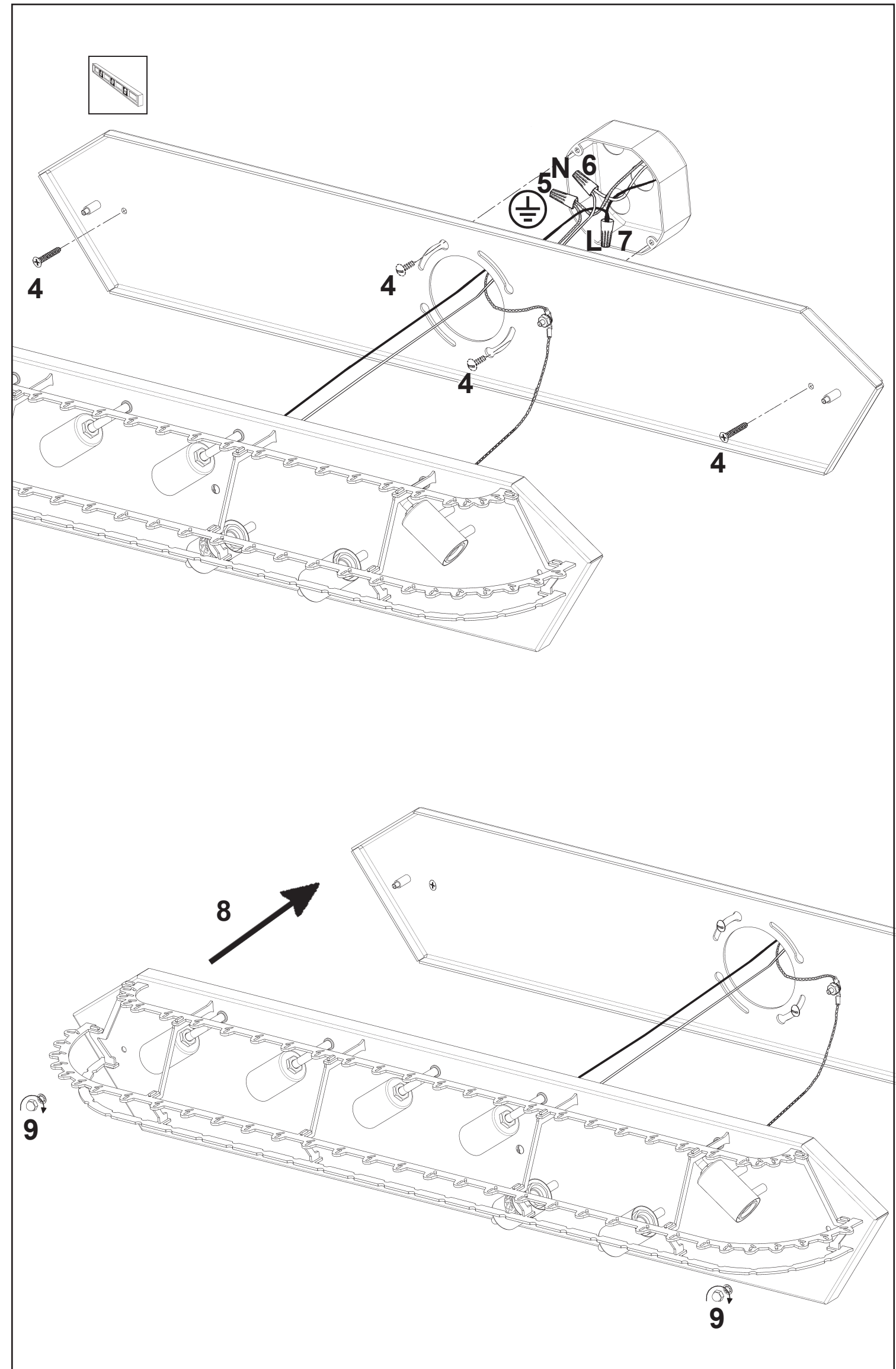
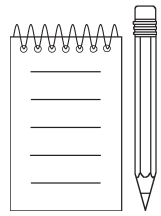

10

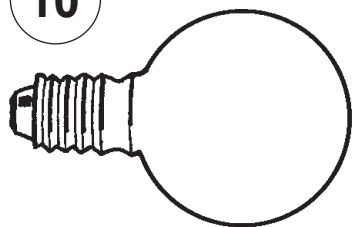

You will need 7 - G16-1/2
40 Watts Max

Install bulbs and be sure
to test fixture BEFORE
trimming.

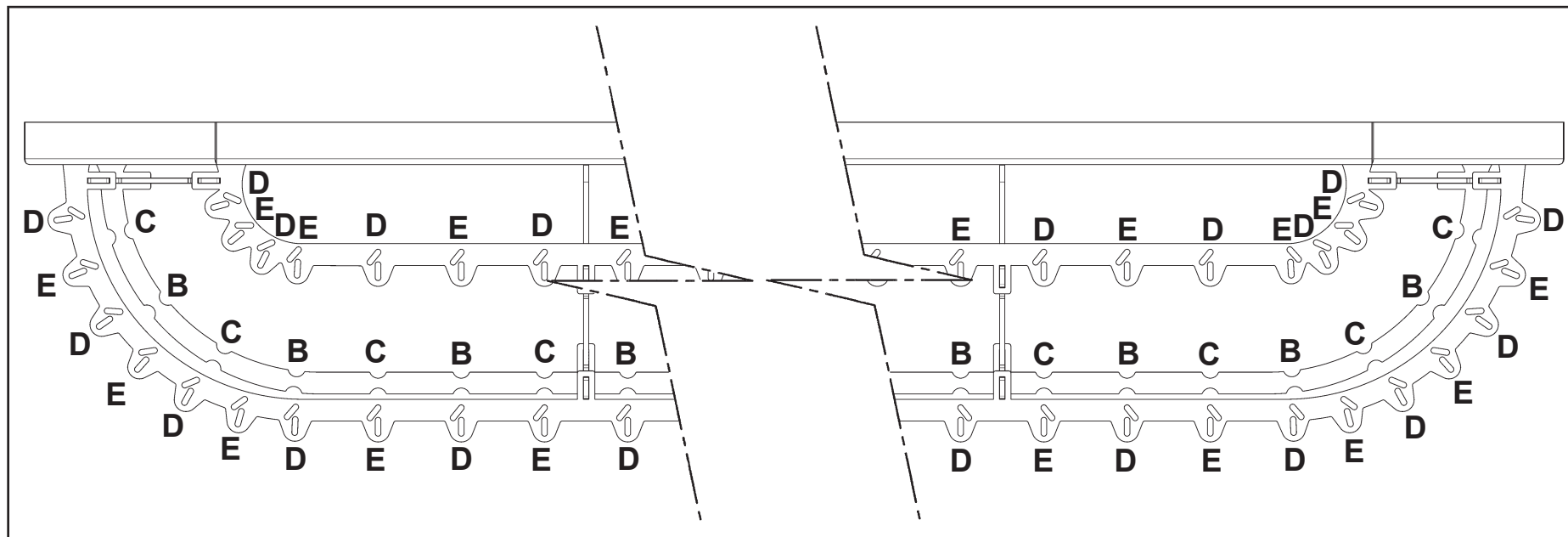
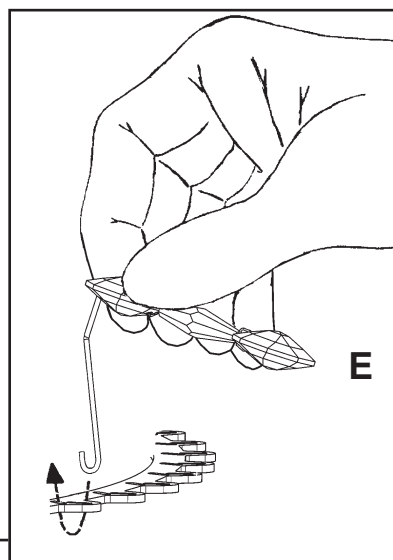

13

14

15

16

11

12

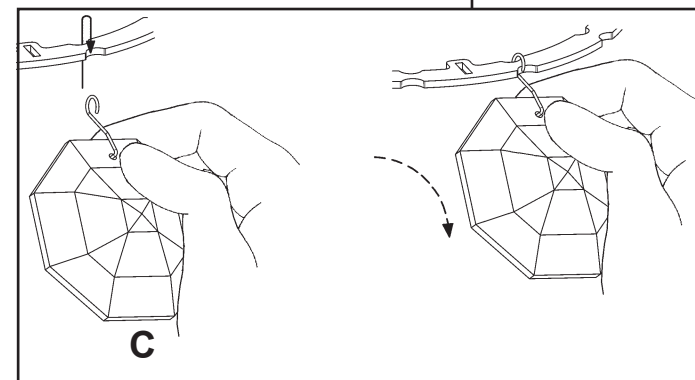
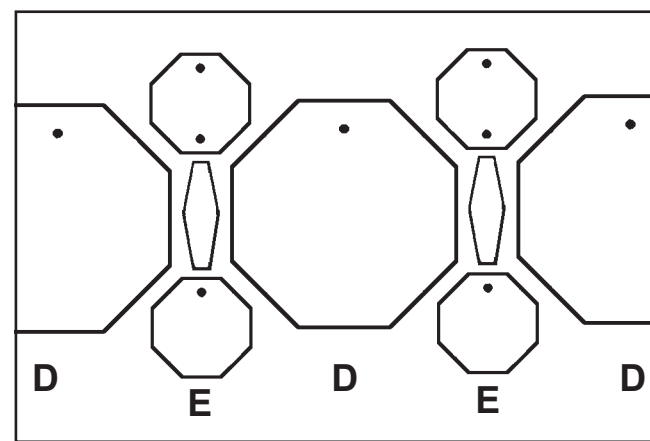
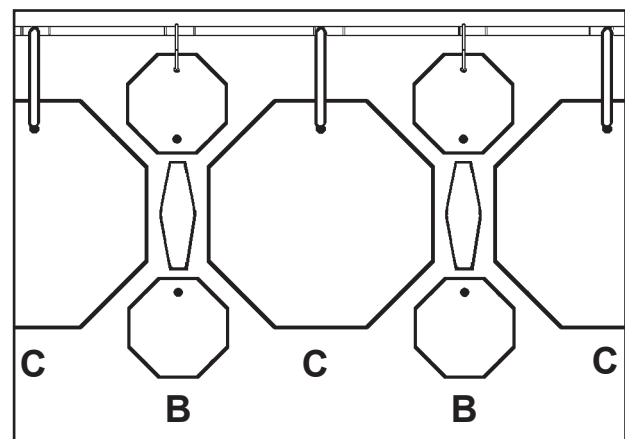
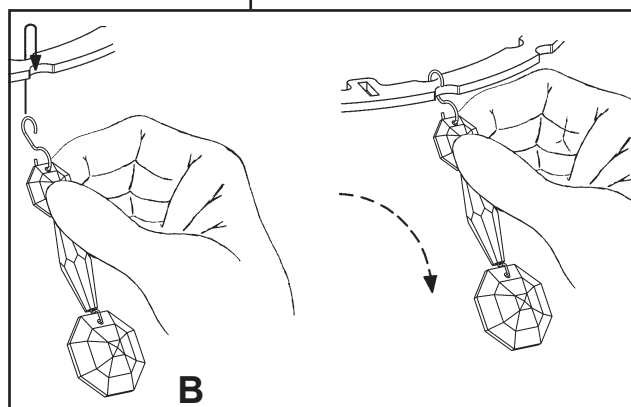

BARONET BN1236N- __ __ R

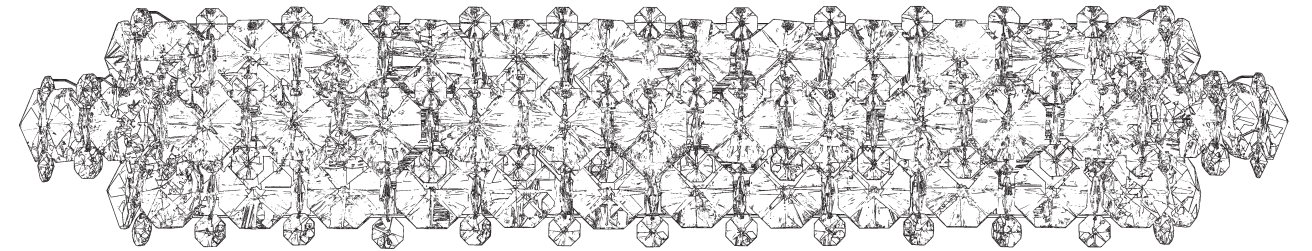











 **SCHONBEK** | 1870

THIS DESIGN IS THE PROPRIETARY
TRADE DRESS/TRADEMARK OF
W SCHONBEK LLC.

7 Lights
Diameter: 35"
Height: 6-1/2"
Extension: 6-1/2"
Hanging Weight: 18lbs.

 **SCHONBEK** | 1870

								
MAX <u>40</u> W	110-120 V							

WARNING:

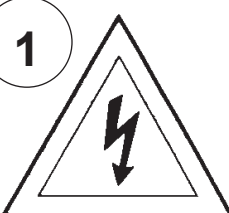
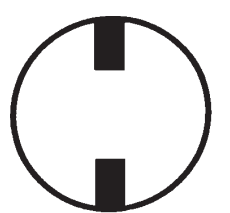
1  

Electrical Danger **Turn Power Off**

All electrical components must be installed by a licensed electrician in accordance with the National Electric Code and the appropriate local electrical codes.

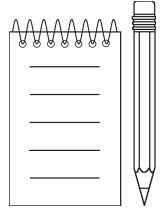
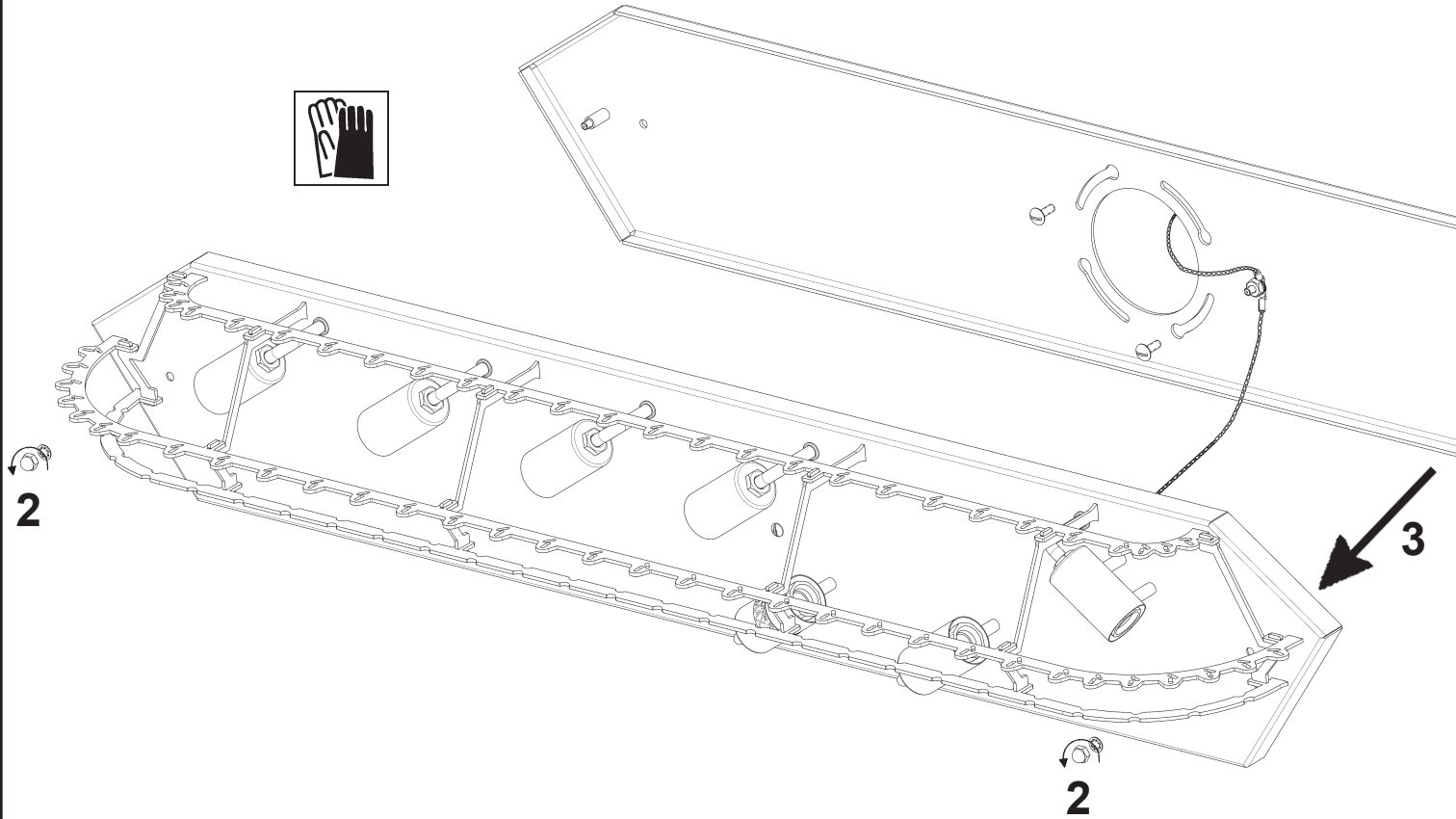

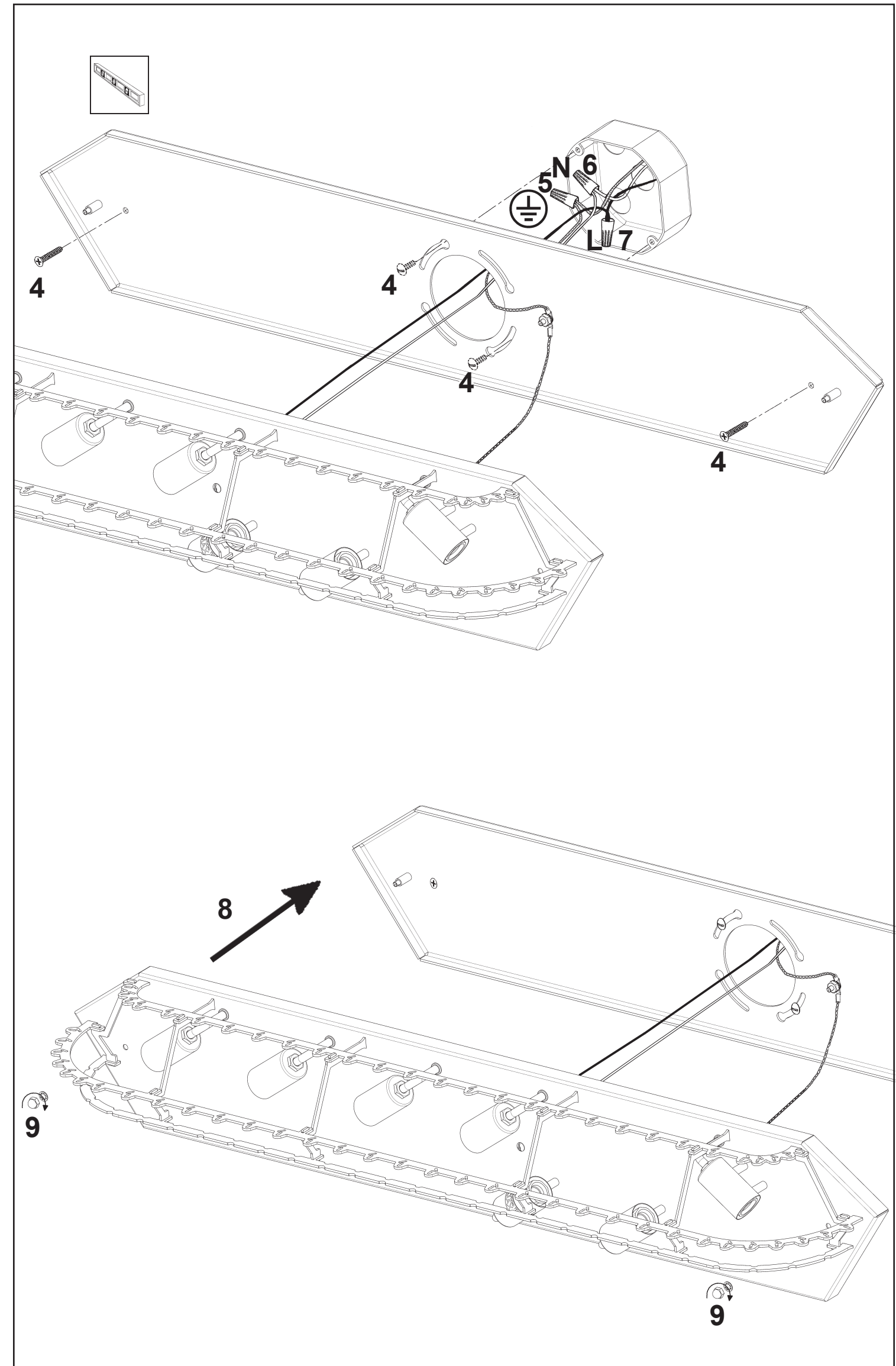
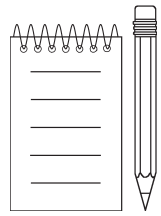

10

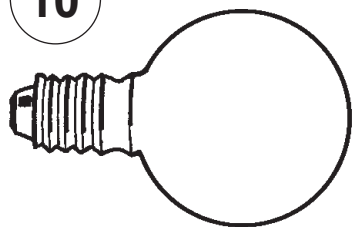

You will need 7 - G16-1/2
40 Watts Max

Install bulbs and be sure
to test fixture BEFORE
trimming.

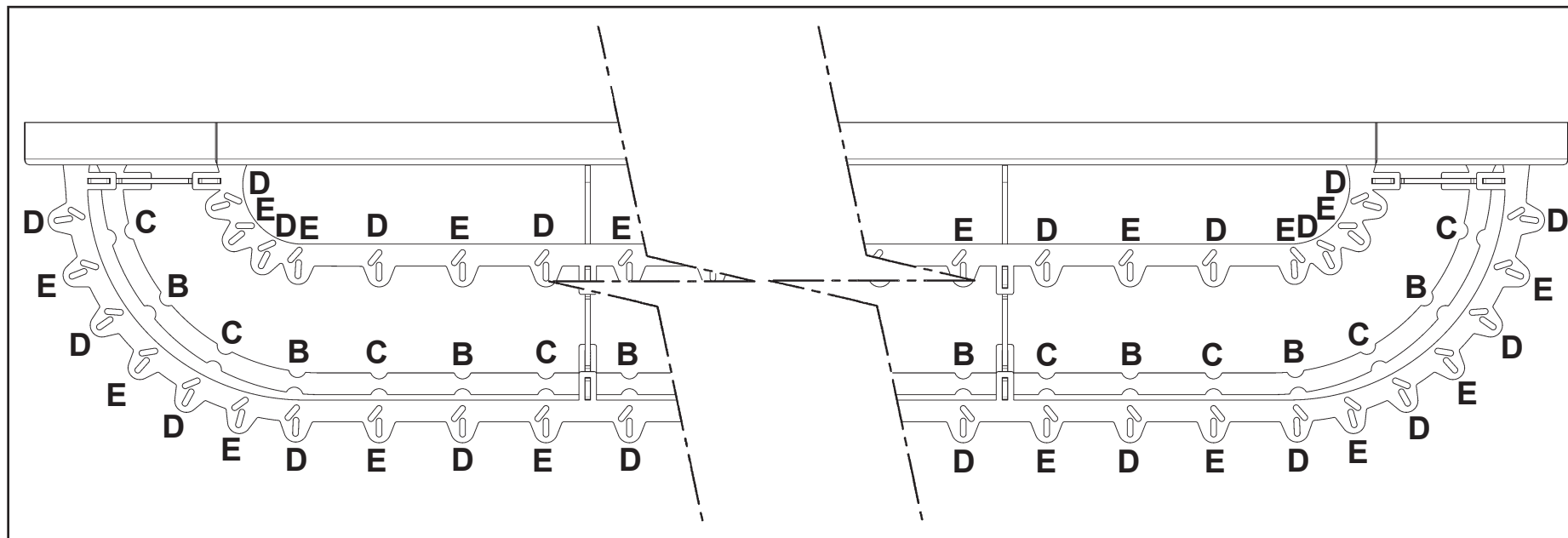
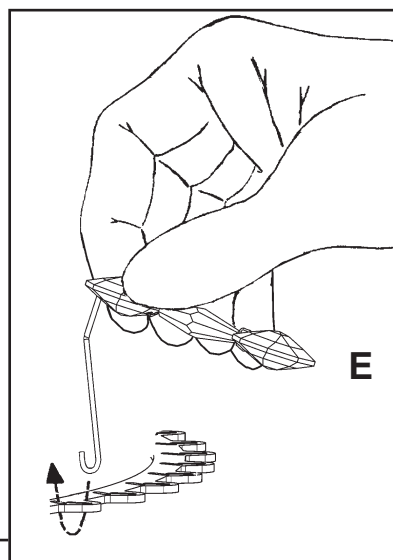

13

14

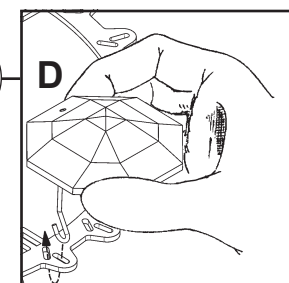

15

16

11

12

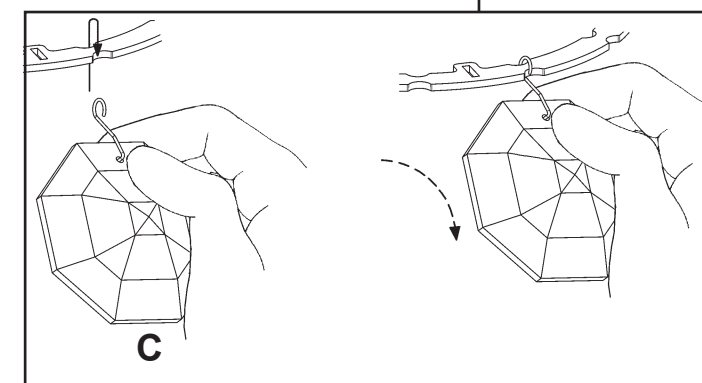
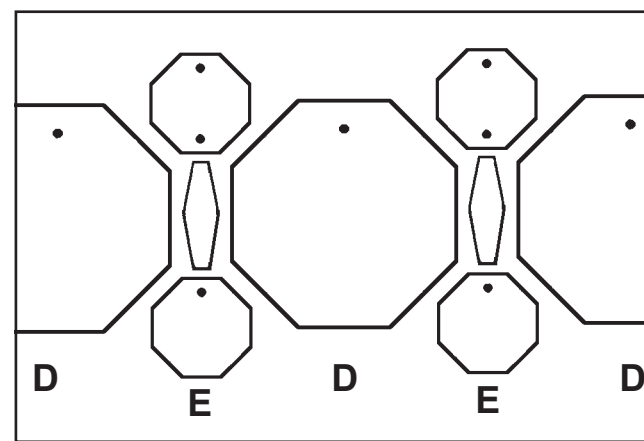
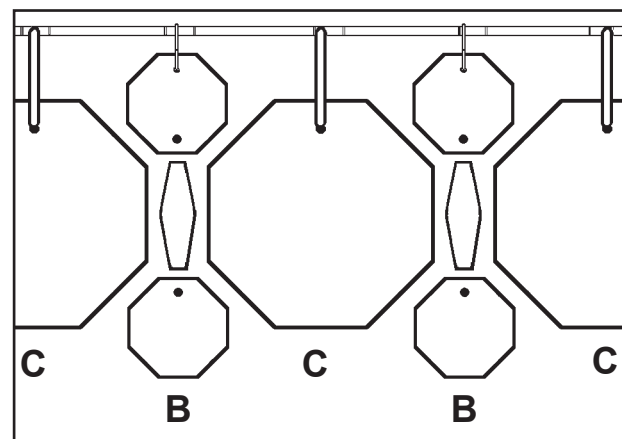
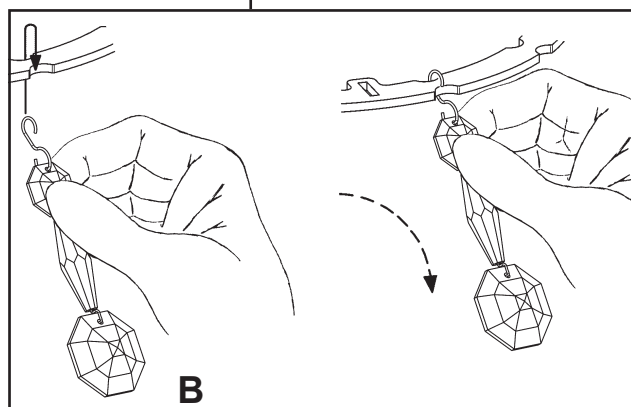

BARONET BN1236N- __ __ S

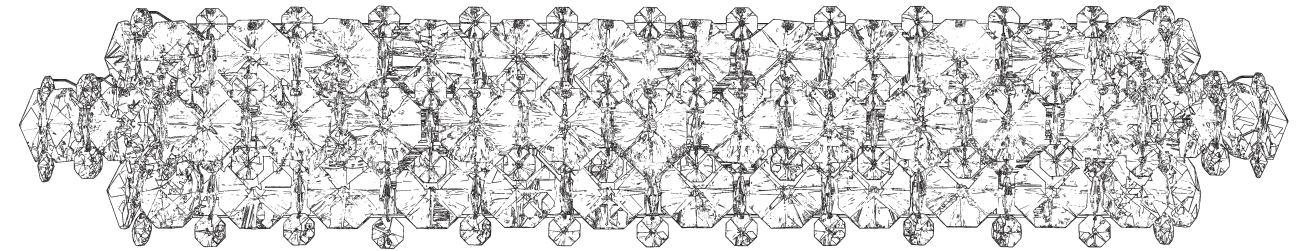











 **SCHONBEK** | 1870

THIS DESIGN IS THE PROPRIETARY
TRADE DRESS/TRADEMARK OF
W SCHONBEK LLC.

7 Lights
Diameter: 35"
Height: 6-1/2"
Extension: 6-1/2"
Hanging Weight: 18lbs.

 **SCHONBEK** | 1870

								
MAX 40 W	110-120 V							

WARNING:

1

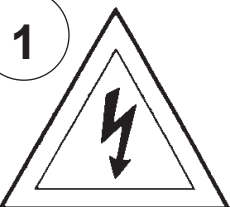

Electrical Danger **Turn Power Off**

All electrical components must be installed by a licensed electrician in accordance with the National Electric Code and the appropriate local electrical codes.

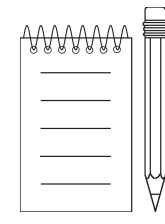
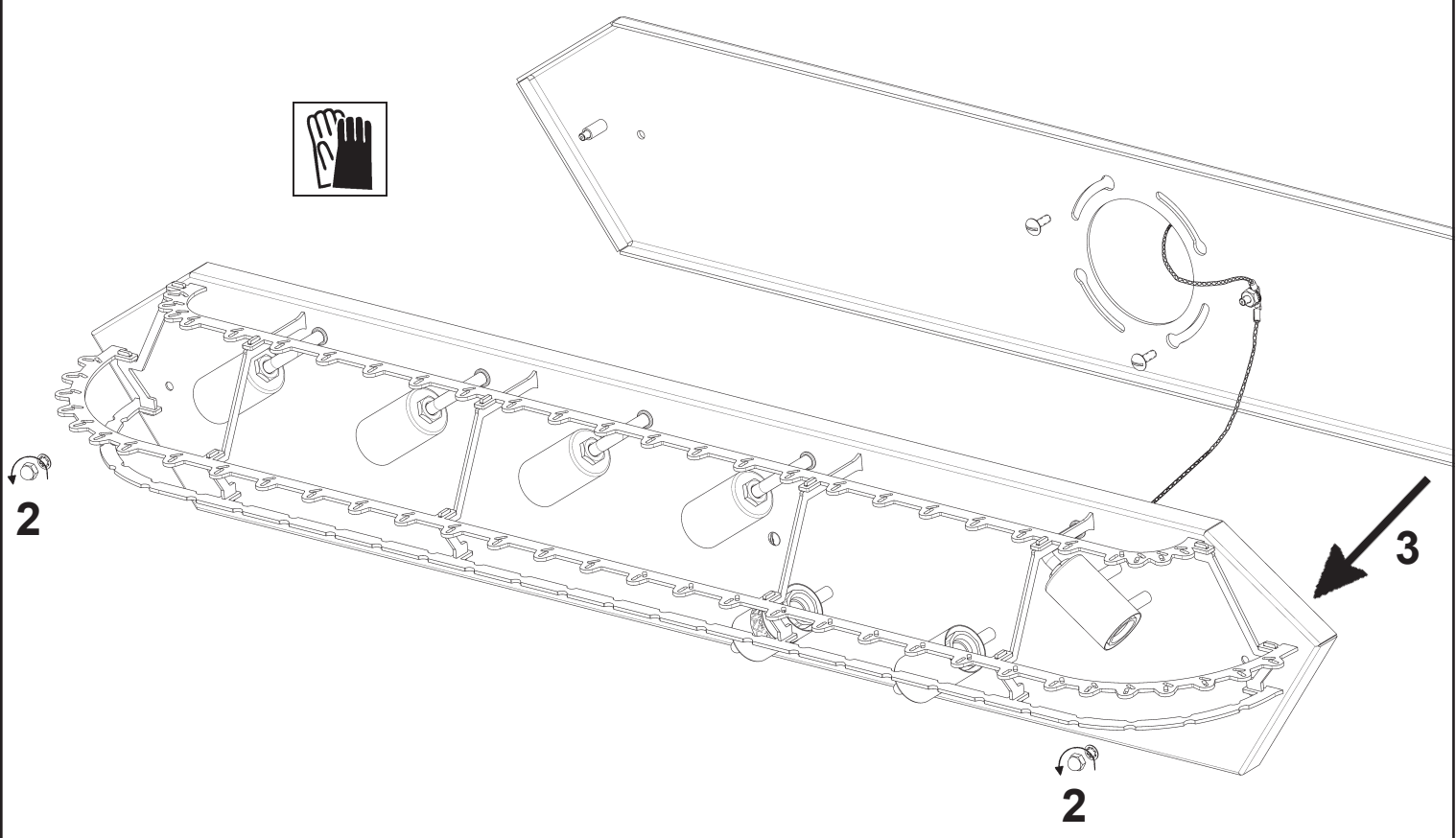

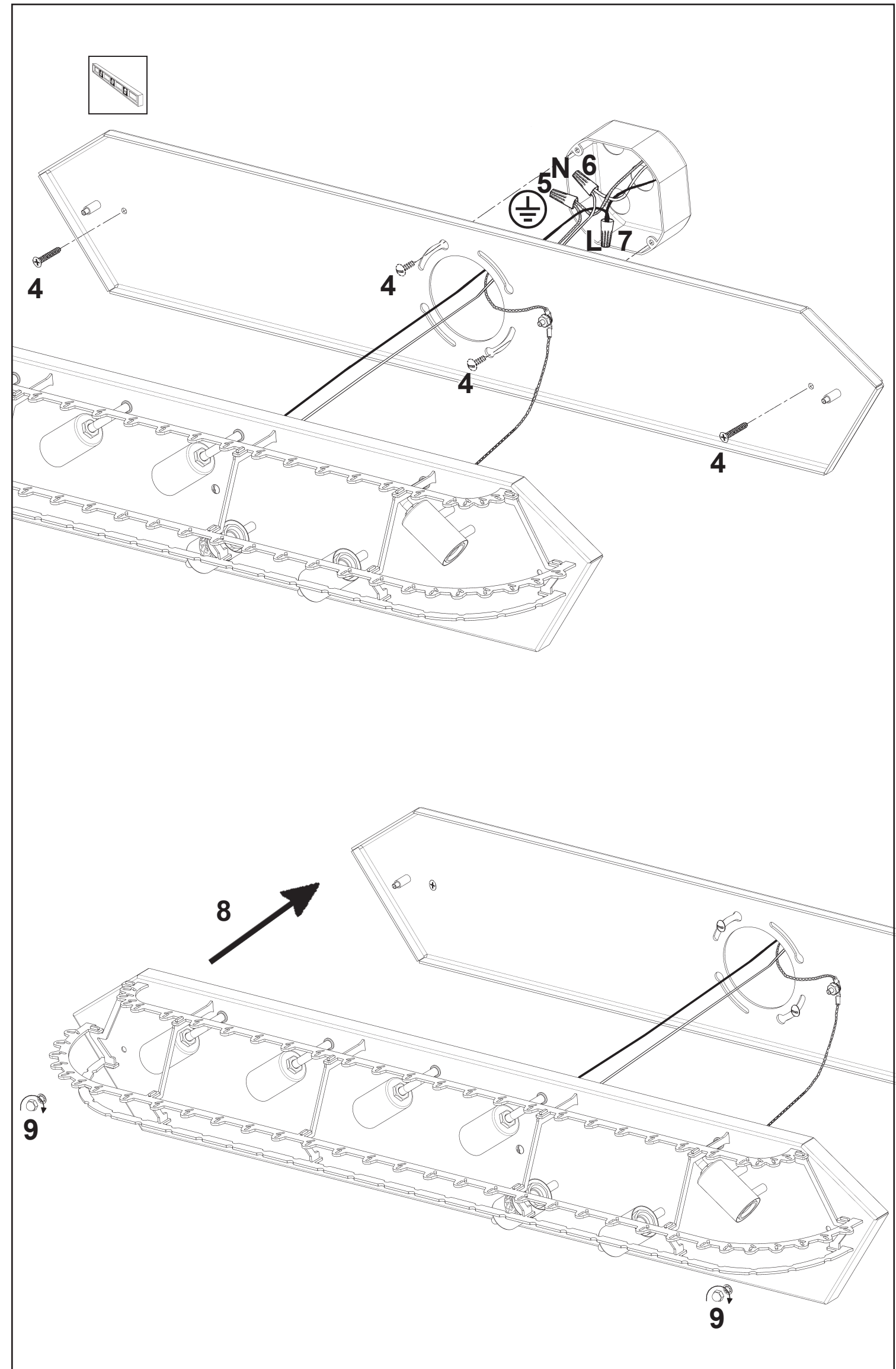
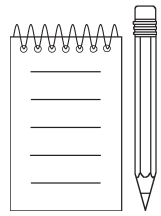

10

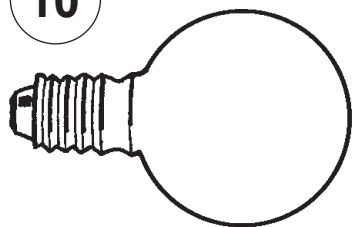

You will need 7 - G16-1/2
40 Watts Max

Install bulbs and be sure
to test fixture BEFORE
trimming.

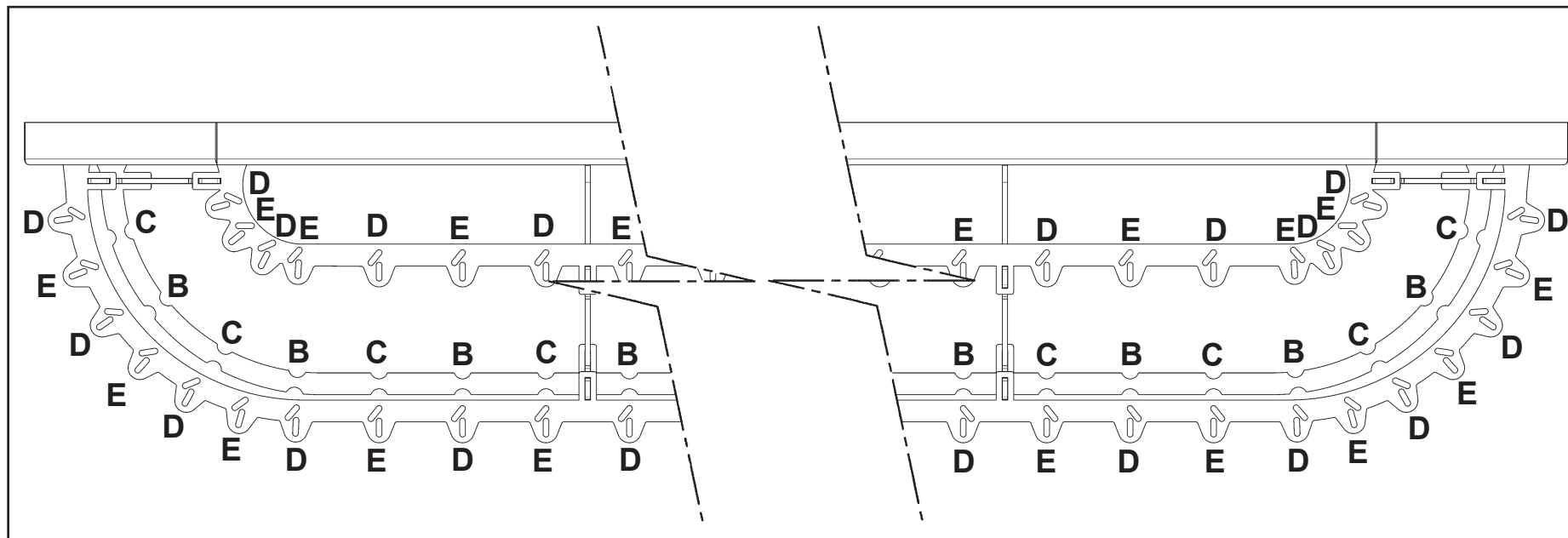
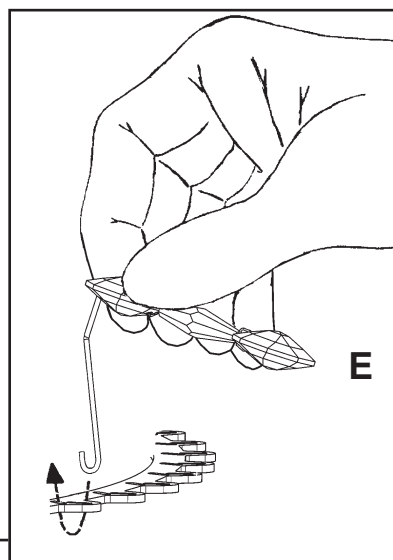

13

14

15

16

11

12

