

MILANO 5641- \_\_\_\_\_

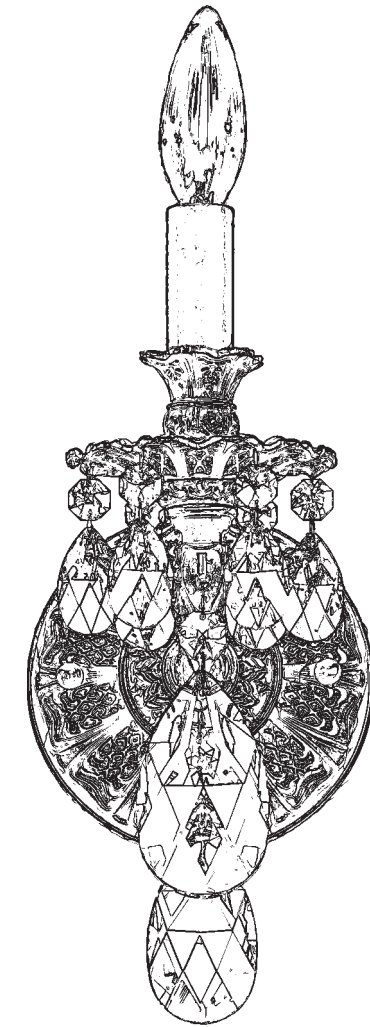









 **SCHONBEK** | 1870



1 Light  
Diameter: 5"  
Body Length: 13-1/2"  
Extension: 7"  
Hanging Weight: 2-1/2lbs.

**T**HIS DESIGN IS THE PROPRIETARY  
TRADE DRESS/TRADEMARK OF  
W SCHONBEK LLC.

 **SCHONBEK** | 1870

								
MAX <b>60</b> W		110-120 V						

All electrical components must be installed by a licensed electrician in accordance with the National Electric Code and the appropriate local electrical codes.

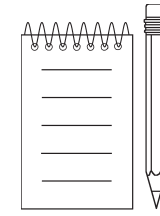
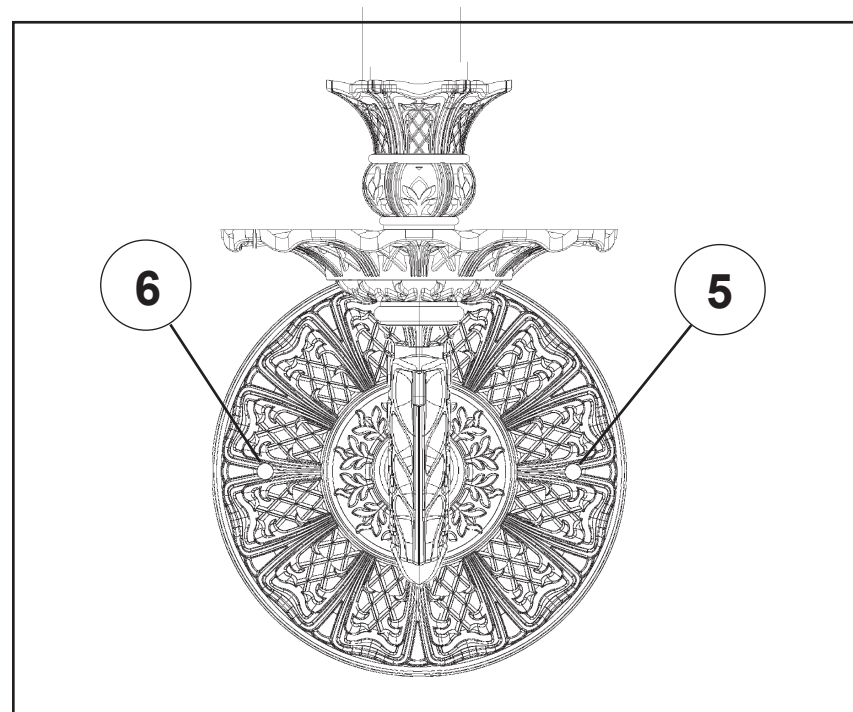
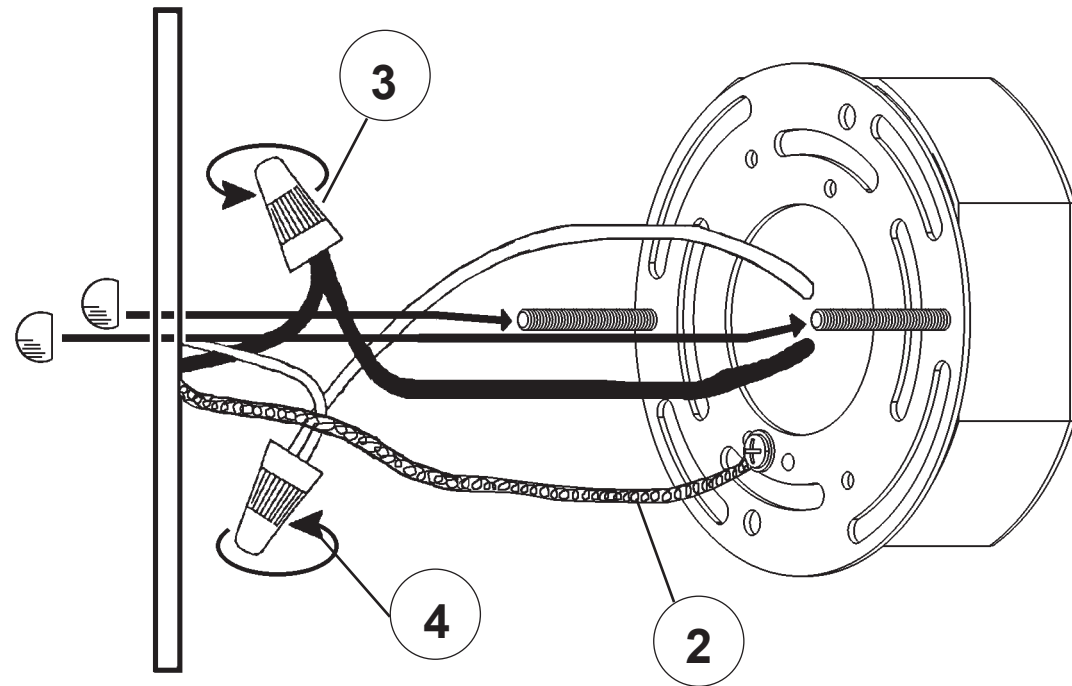
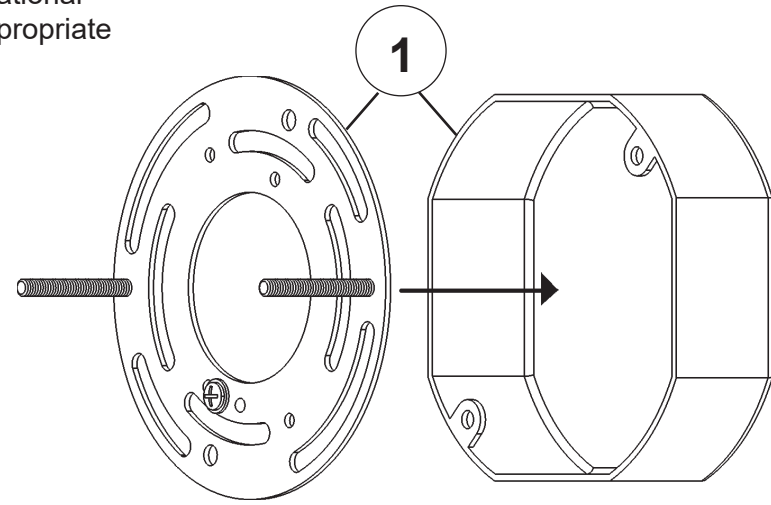

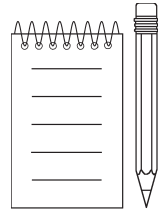

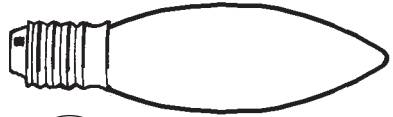

7

You will need 1 - B10  
25 Watts Recommended  
60 Watts Max

Install bulb and be sure  
to test fixture **BEFORE**  
trimming.

### DIAGRAM #1

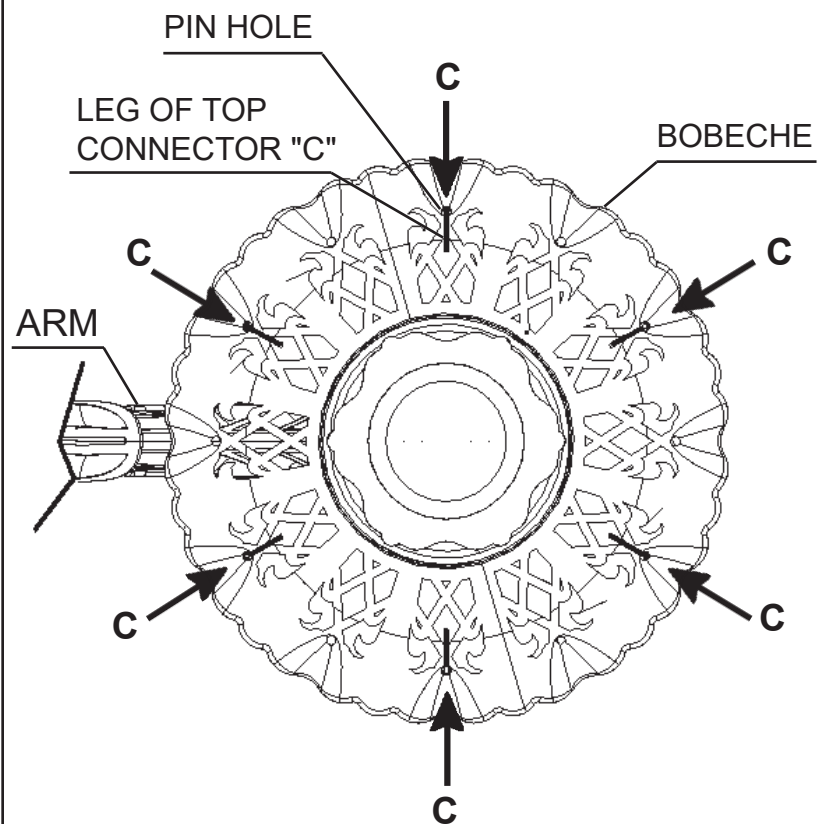

When trimming bobèche with letter "C", insert leg  
of top connector into pin hole from under bobèche.  
Hang in every other pin hole starting on either side of  
the arm (refer to Diagram #1)

