

NEW ORLEANS 3656- ___ _H

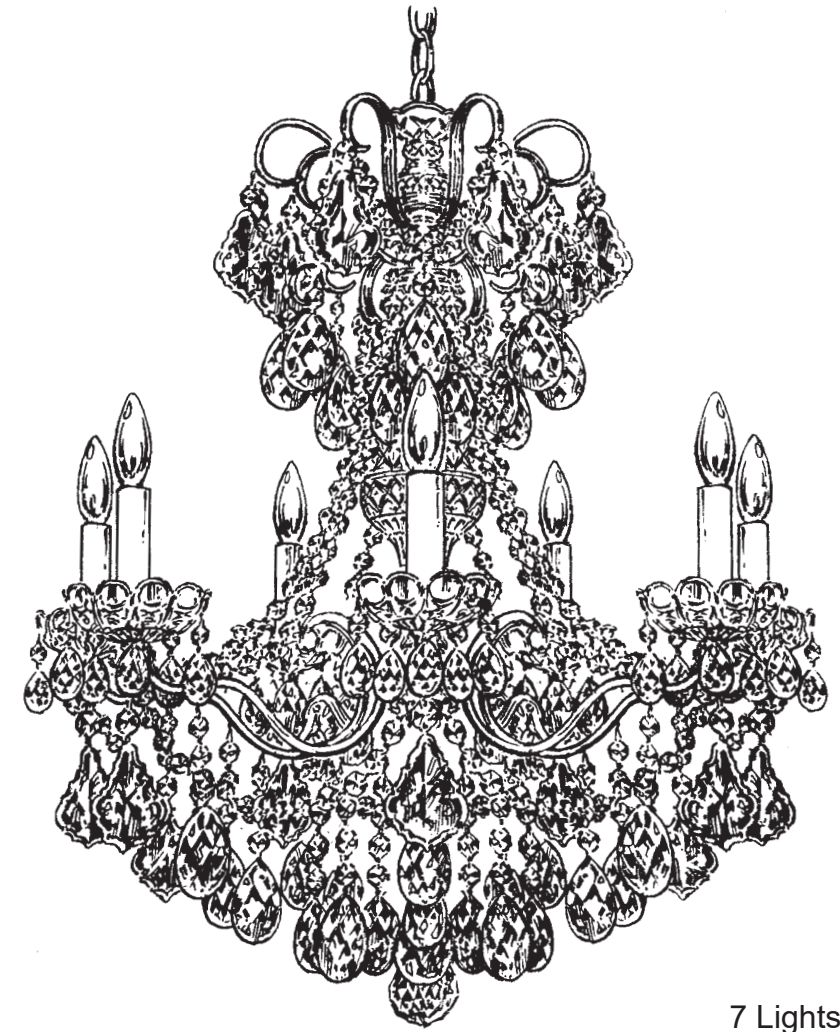











7 Lights
Diameter: 24"
Body Length: 27"
Hanging Weight: 16 lbs.

THIS DESIGN IS THE PROPRIETARY TRADE DRESS/TRADEMARK OF W SCHONBEK LLC.

 **SCHONBEK** | 1870

 **SCHONBEK** | 1870

								
MAX 60 W		110-120 V						

All electrical components must be installed by a licensed electrician in accordance with the National Electric Code and the appropriate local electrical codes.

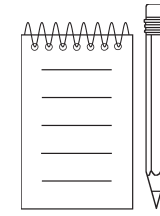
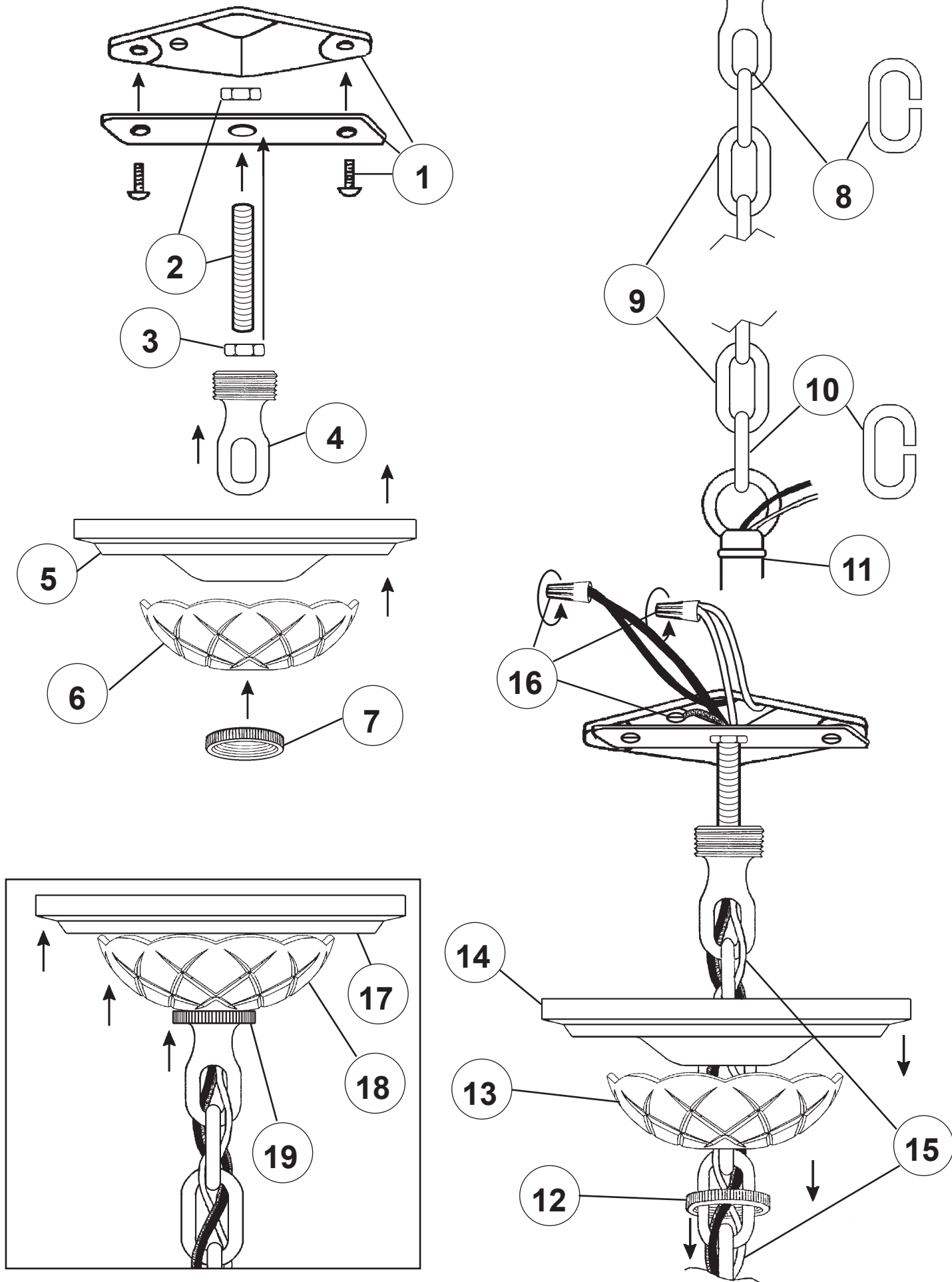



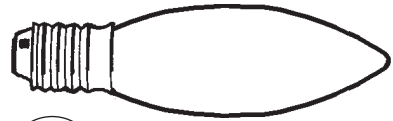

20

You will need 7 - B10
25 Watts Recommended
60 Watts Max

Install bulb and be sure
to test fixture **BEFORE**
trimming.

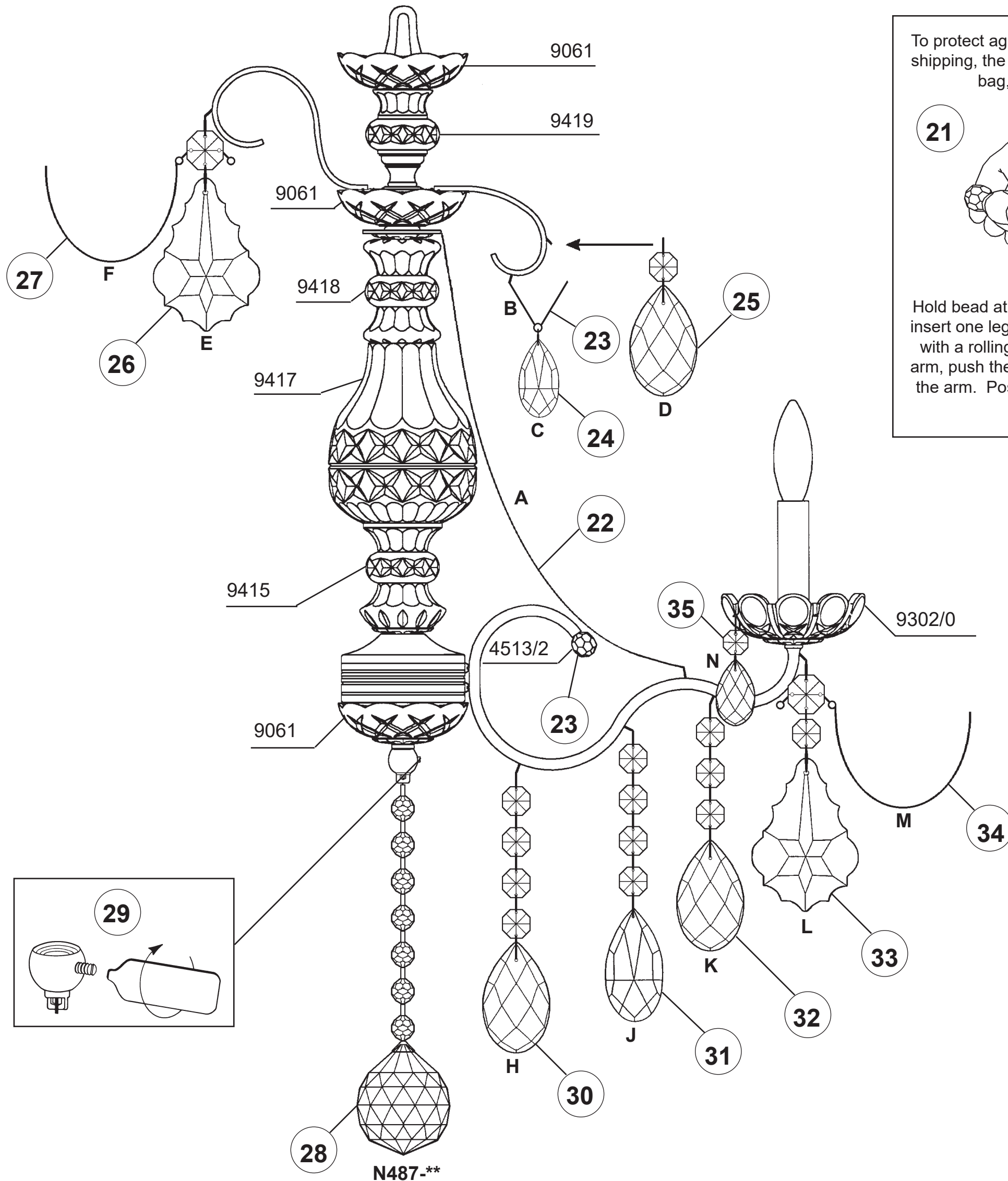

To protect against breakage and loss during shipping, the beads are supplied in a plastic bag, packed with the trim.

21

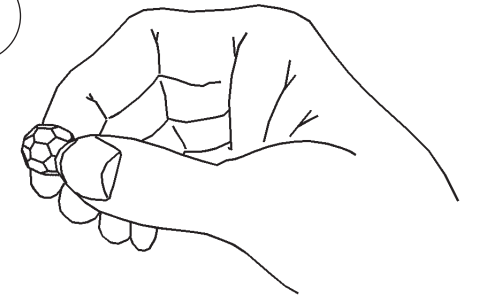

Hold bead at an angle to the arm as shown, insert one leg of the holder into the arm and, with a rolling motion across the end of the arm, push the other leg of the connector into the arm. Position so that the bead is in the center of the arm.

