

# 2022 Collections

General  
Catalog

---

Interactive  
version

# Index

## 02 Product Finder

- 02 ALPHABETICAL INDEX
- 03 LOOK INDEX
- 04 PORCELAIN TILES SIZE INDEX
- 06 WALL TILES SIZE INDEX
- 07 OUTDOOR SIZE INDEX
  
- 08 PORCELAIN TILES SURFACE RANGE
- 16 OUTDOOR SURFACE RANGE
- 20 WALL TILES SURFACE RANGE
- 28 PORCELAIN TILE DECORS SURFACE RANGE
- 50 WALL TILE DECORS SURFACE RANGE

## 62 Company

- 64 ABOUT US
- 94 RESPONSIBILITY
- 98 VALUES OF CERAMICS

## 104 Collections

- 106 3D WALL
- 116 CONCRETE & RESIN LOOK
- 198 METAL LOOK
- 206 MARBLE LOOK
- 276 STONE LOOK
- 352 WOOD LOOK
  
- 390 LARGE SIZES

## 434 Technical Specifications

- 436 SIZES RANGE
- 440 PORCELAIN TILES TECHNICAL SPECIFICATION
- 455 UPEC CERTIFICATION
- 456 ANTI-SLIP CLASSIFICATION
- 459 DESTINATIONS OF USE FOR PORCELAIN TILES
- 462 TRIM TILES - INDOOR AND OUTDOOR
- 466 WALL TILES TECHNICAL SPECIFICATION
- 470 PACKING AND WEIGHT
- 476 LAYING SUGGESTIONS
- 488 GENERAL SALES CONDITIONS

PRODUCT  
FINDER



SURFACE  
RANGE



COMPANY



COLLECTIONS



LARGE SIZES



TECHNICAL  
SPECIFICATIONS



# Alphabetical Index

106	3D WALL CARVE		Wall Tiles
110	3D WALL DESIGN		Wall Tiles
276	AIX	Porcelain Tiles	Wall Tiles
188	APLOMB		Wall Tiles
194	ARTY		Wall Tiles
352	AXI	Porcelain Tiles	
198	BLAZE	Porcelain Tiles	Wall Tiles
116	BOOST	Porcelain Tiles	Wall Tiles
284	BOOST MIX	Porcelain Tiles	
124	BOOST NATURAL	Porcelain Tiles	Wall Tiles
132	BOOST PRO	Porcelain Tiles	Wall Tiles
290	BOOST STONE	Porcelain Tiles	
296	BRAVE	Porcelain Tiles	Wall Tiles
114	CANONE INVERSO	Porcelain Tiles	
304	DOLMEN PRO	Porcelain Tiles	
140	DWELL	Porcelain Tiles	Wall Tiles
360	ETIC	Porcelain Tiles	
364	ETIC PRO	Porcelain Tiles	
370	EXENCE	Porcelain Tiles	
378	HEARTWOOD	Porcelain Tiles	
388	GROUNDTRACK	Porcelain Tiles	
310	KLIF	Porcelain Tiles	Wall Tiles
318	KONE	Porcelain Tiles	
324	LIMS	Porcelain Tiles	Wall Tiles
148	MARK	Porcelain Tiles	
206	MARVEL	Porcelain Tiles	Wall Tiles
220	MARVEL DREAM	Porcelain Tiles	Wall Tiles
228	MARVEL EDGE	Porcelain Tiles	Wall Tiles
238	MARVEL GEMS	Porcelain Tiles	
240	MARVEL PRO	Porcelain Tiles	Wall Tiles
254	MARVEL SHINE	Porcelain Tiles	Wall Tiles
266	MARVEL STONE – Marble Look	Porcelain Tiles	Wall Tiles
332	MARVEL STONE – Stone Look	Porcelain Tiles	
154	MEK	Porcelain Tiles	Wall Tiles
382	NID	Porcelain Tiles	
338	NORDE	Porcelain Tiles	
162	PRISM	Porcelain Tiles	Wall Tiles
172	RAW	Porcelain Tiles	Wall Tiles
346	TRUST	Porcelain Tiles	
182	VENTI BOOST	Porcelain Tiles	

# Look Index

<b>3D Wall</b>	106	3D WALL CARVE		Wall Tiles
	110	3D WALL DESIGN		Wall Tiles
<b>Concrete &amp; Resin Look</b>	116	BOOST	Porcelain Tiles	Wall Tiles
	124	BOOST NATURAL	Porcelain Tiles	Wall Tiles
	132	BOOST PRO	Porcelain Tiles	Wall Tiles
	114	CANONE INVERSO	Porcelain Tiles	
	140	DWELL	Porcelain Tiles	Wall Tiles
	148	MARK	Porcelain Tiles	
	154	MEK	Porcelain Tiles	Wall Tiles
	162	PRISM	Porcelain Tiles	Wall Tiles
	172	RAW	Porcelain Tiles	Wall Tiles
	182	VENTI BOOST	Porcelain Tiles	
	188	APLOMB		Wall Tiles
	194	ARTY		Wall Tiles
<b>Metal Look</b>	198	BLAZE	Porcelain Tiles	Wall Tiles
<b>Marble Look</b>	206	MARVEL	Porcelain Tiles	Wall Tiles
	220	MARVEL DREAM	Porcelain Tiles	Wall Tiles
	228	MARVEL EDGE	Porcelain Tiles	Wall Tiles
	238	MARVEL GEMS	Porcelain Tiles	
	240	MARVEL PRO	Porcelain Tiles	Wall Tiles
	254	MARVEL SHINE	Porcelain Tiles	Wall Tiles
	266	MARVEL STONE	Porcelain Tiles	Wall Tiles
<b>Stone Look</b>	276	AIX	Porcelain Tiles	Wall Tiles
	284	BOOST MIX	Porcelain Tiles	
	290	BOOST STONE	Porcelain Tiles	
	296	BRAVE	Porcelain Tiles	Wall Tiles
	304	DOLMEN PRO	Porcelain Tiles	
	310	KLIF	Porcelain Tiles	Wall Tiles
	318	KONE	Porcelain Tiles	
	324	LIMS	Porcelain Tiles	Wall Tiles
	332	MARVEL STONE	Porcelain Tiles	
	338	NORDE	Porcelain Tiles	
	346	TRUST	Porcelain Tiles	
<b>Wood Look</b>	352	AXI	Porcelain Tiles	
	360	ETIC	Porcelain Tiles	
	364	ETIC PRO	Porcelain Tiles	
	370	EXENCE	Porcelain Tiles	
	378	HEARTWOOD	Porcelain Tiles	
	382	NID	Porcelain Tiles	
	388	GROUNDTRACK	Porcelain Tiles	

INDEX



PRODUCT FINDER



ALPHABETICAL INDEX

LOOK INDEX

PORCELAIN TILES SIZE INDEX

WALL TILES SIZE INDEX

OUTDOOR SURFACE INDEX

SURFACE RANGE



COMPANY



COLLECTIONS



LARGE SIZES



TECHNICAL SPECIFICATIONS



WEBSITE >  
DOWNLOAD AREA

# Porcelain Tiles Size Index

**160x320** 

116	BOOST	Concrete Look
132	BOOST PRO	Concrete Look
206	MARVEL	Marble Look
240	MARVEL PRO	Marble Look
254	MARVEL SHINE	Marble Look
266	MARVEL STONE	Marble Look

**160x160** 

116	BOOST	Concrete Look
132	BOOST PRO	Concrete Look
206	MARVEL	Marble Look
240	MARVEL PRO	Marble Look
254	MARVEL SHINE	Marble Look
266	MARVEL STONE	Marble Look

**120x278** 

198	BLAZE	Metal Look
116	BOOST	Concrete Look
284	BOOST MIX	Stone Look
124	BOOST NATURAL	Concrete Look
132	BOOST PRO	Concrete Look
290	BOOST STONE	Stone Look
324	LIMS	Stone Look
206	MARVEL	Marble Look
220	MARVEL DREAM	Marble Look
228	MARVEL EDGE	Marble Look
240	MARVEL PRO	Marble Look
254	MARVEL SHINE	Marble Look
266	MARVEL STONE	Marble Look
162	PRISM	Concrete Look
172	RAW	Concrete Look

**120x240** 

116	BOOST	Concrete Look
132	BOOST PRO	Concrete Look
206	MARVEL	Marble Look
220	MARVEL DREAM	Marble Look
228	MARVEL EDGE	Marble Look
240	MARVEL PRO	Marble Look
254	MARVEL SHINE	Marble Look
266	MARVEL STONE	Marble Look
332	MARVEL STONE	Stone Look

**120x120** 

276	AIX	Stone Look
198	BLAZE	Metal Look
116	BOOST	Concrete Look
284	BOOST MIX	Stone Look
124	BOOST NATURAL	Concrete Look
132	BOOST PRO	Concrete Look
290	BOOST STONE	Stone Look
140	DWELL	Concrete Look
318	KONE	Stone Look
324	LIMS	Stone Look
206	MARVEL	Marble Look
220	MARVEL DREAM	Marble Look
228	MARVEL EDGE	Marble Look

**60x120** 

240	MARVEL PRO	Marble Look
254	MARVEL SHINE	Marble Look
266	MARVEL STONE	Marble Look
332	MARVEL STONE	Stone Look
162	PRISM	Concrete Look
172	RAW	Concrete Look

**60x60** 

116	BOOST	Concrete Look
284	BOOST MIX	Stone Look
124	BOOST NATURAL	Concrete Look
132	BOOST PRO	Concrete Look
290	BOOST STONE	Stone Look
206	MARVEL	Marble Look
220	MARVEL DREAM	Marble Look
240	MARVEL PRO	Marble Look
254	MARVEL SHINE	Marble Look
266	MARVEL STONE	Marble Look
338	NORDE	Stone Look
162	PRISM	Concrete Look

**75x150** 

276	AIX	Stone Look
198	BLAZE	Metal Look
116	BOOST	Concrete Look
132	BOOST PRO	Concrete Look
296	BRAVE	Stone Look
318	KONE	Stone Look
310	KLIF	Stone Look
324	LIMS	Stone Look
206	MARVEL	Marble Look
220	MARVEL DREAM	Marble Look
228	MARVEL EDGE	Marble Look
240	MARVEL PRO	Marble Look
254	MARVEL SHINE	Marble Look
266	MARVEL STONE	Marble Look
332	MARVEL STONE	Stone Look
172	RAW	Concrete Look

**75x75** 

276	AIX	Stone Look
198	BLAZE	Metal Look
116	BOOST	Concrete Look
132	BOOST PRO	Concrete Look
296	BRAVE	Stone Look
318	KONE	Stone Look
310	KLIF	Stone Look
324	LIMS	Stone Look
206	MARVEL	Marble Look
220	MARVEL DREAM	Marble Look
228	MARVEL EDGE	Marble Look
240	MARVEL PRO	Marble Look
254	MARVEL SHINE	Marble Look
266	MARVEL STONE	Marble Look
332	MARVEL STONE	Stone Look
172	RAW	Concrete Look

**37,5x75** 

276	AIX	Stone Look
198	BLAZE	Metal Look
116	BOOST	Concrete Look
132	BOOST PRO	Concrete Look
304	DOLMEN PRO	Stone Look
310	KLIF	Stone Look
324	LIMS	Stone Look
220	MARVEL DREAM	Marble Look
254	MARVEL SHINE	Marble Look
172	RAW	Concrete Look

**60x60** 

116	BOOST	Concrete Look
284	BOOST MIX	Stone Look
124	BOOST NATURAL	Concrete Look
132	BOOST PRO	Concrete Look
290	BOOST STONE	Stone Look
296	BRAVE	Stone Look
140	DWELL	Concrete Look
318	KONE	Stone Look
148	MARK	Concrete Look
206	MARVEL	Marble Look
220	MARVEL DREAM	Marble Look
228	MARVEL EDGE	Marble Look
238	MARVEL GEMS	Marble Look
240	MARVEL PRO	Marble Look
254	MARVEL SHINE	Marble Look
266	MARVEL STONE	Marble Look
332	MARVEL STONE	Stone Look
154	MEK	Concrete Look
338	NORDE	Stone Look
162	PRISM	Concrete Look
172	RAW	Concrete Look
346	TRUST	Stone Look

**30x60** 

116	BOOST	Concrete Look
284	BOOST MIX	Stone Look
124	BOOST NATURAL	Concrete Look
132	BOOST PRO	Concrete Look
290	BOOST STONE	Stone Look
296	BRAVE	Stone Look
140	DWELL	Concrete Look
318	KONE	Stone Look
148	MARK	Concrete Look

**45x90** 

206	MARVEL	Marble Look
228	MARVEL EDGE	Marble Look
240	MARVEL PRO	Marble Look
254	MARVEL SHINE	Marble Look
266	MARVEL STONE	Marble Look
332	MARVEL STONE	Stone Look
154	MEK	Concrete Look
338	NORDE	Stone Look
162	PRISM	Concrete Look
172	RAW	Concrete Look
346	TRUST	Stone Look

**25x150** 

296	BRAVE	Stone Look
206	MARVEL	Marble Look
228	MARVEL EDGE	Marble Look
240	MARVEL PRO	Marble Look
266	MARVEL STONE	Marble Look
332	MARVEL STONE	Stone Look
154	MEK	Concrete Look
346	TRUST	Stone Look

**18,5x150** 

364	ETIC PRO	Wood Look
382	NID	Wood Look
370	EXENCE	Wood Look
378	HEARTWOOD	Wood Look
382	NID	Wood Look

**20x120** 

370	EXENCE	Wood Look
378	HEARTWOOD	Wood Look

**22,5x90** 

352	AXI	Wood Look
360	ETIC	Wood Look
364	ETIC PRO	Wood Look

**15x90** 

360	ETIC	Wood Look
364	ETIC PRO	Wood Look
382	NID	Wood Look

**30x30** 

388	GROUDTRACK	
276	AIX	Stone Look
304	DOLMEN PRO	Stone Look

**22,5x22,5** 

276	AIX	Stone Look
304	DOLMEN PRO	Stone Look

**20x20** 

182	VENTI BOOST	Concrete Look
-----	-------------	---------------

INDEX



PRODUCT FINDER



ALPHABETICAL INDEX  
LOOK INDEX

PORCELAIN TILES SIZE INDEX

WALL TILES SIZE INDEX  
OUTDOOR SURFACE INDEX

SURFACE RANGE



COMPANY



COLLECTIONS







LARGE SIZES

















TECHNICAL SPECIFICATIONS



# Wall Tiles Size Index

<b>50x120</b> 	110	3D WALL DESIGN		
	188	APLOMB	Concrete Look	
	130	BOOST NATURAL	Concrete Look	
	204	BLAZE	Metal Look	
	216	MARVEL	Marble Look	
	226	MARVEL DREAM	Marble Look	
	234	MARVEL EDGE	Marble Look	
	250	MARVEL PRO	Marble Look	
	264	MARVEL SHINE	Marble Look	
	274	MARVEL STONE	Marble Look	
	160	MEK	Concrete Look	
	168	PRISM	Concrete Look	
	178	RAW	Concrete Look	
	<b>40x80</b> 	106	3D WALL CARVE	
110		3D WALL DESIGN		
282		AIX	Stone Look	
194		ARTY	Concrete Look	
122		BOOST	Concrete Look	
138		BOOST PRO	Concrete Look	
302		BRAVE	Stone Look	
146		DWELL	Concrete Look	
316		KLIF	Stone Look	
330		LIMS	Stone Look	
216		MARVEL	Marble Look	
234		MARVEL EDGE	Marble Look	
250		MARVEL PRO	Marble Look	
264		MARVEL SHINE	Marble Look	
274		MARVEL STONE	Marble Look	
<b>30,5x91,5</b> 		216	MARVEL	Marble Look
		250	MARVEL PRO	Marble Look
<b>30,5x56</b> 	110	3D WALL DESIGN		
	216	MARVEL	Marble Look	
<b>8,5x31,5</b> 	216	MARVEL	Marble Look	
	250	MARVEL PRO	Marble Look	
	274	MARVEL STONE	Marble Look	

# Outdoor Size Index

<b>120x240</b> 	116	BOOST	20 mm	Concrete Look	
	<b>120x120</b> 	276	AIX	20 mm	Stone Look
		198	BLAZE	20 mm	Metal Look
		116	BOOST	9/20 mm	Concrete Look
		284	BOOST MIX	20 mm	Stone Look
		132	BOOST PRO	9/20 mm	Concrete Look
		124	BOOST NATURAL	9/20 mm	Concrete Look
		290	BOOST STONE	20 mm	Stone Look
		296	BRAVE	20 mm	Stone Look
		162	PRISM	9/20 mm	Concrete Look
172		RAW	20 mm	Concrete Look	
<b>60x120</b> 	116	BOOST	20 mm	Concrete Look	
	284	BOOST MIX	20 mm	Stone Look	
	132	BOOST PRO	20 mm	Concrete Look	
	124	BOOST NATURAL	9/20 mm	Concrete Look	
	290	BOOST STONE	9/20 mm	Stone Look	
	296	BRAVE	20 mm	Stone Look	
	304	DOLMEN PRO	20 mm	Stone Look	
	324	LIMS	20 mm	Stone Look	
	332	MARVEL STONE	20 mm	Stone Look	
	338	NORDE	9/20 mm	Stone Look	
	172	RAW	20 mm	Concrete Look	
	346	TRUST	20 mm	Stone Look	
<b>80x80</b> 	162	PRISM	20 mm	Concrete Look	
	338	NORDE	20 mm	Stone Look	
<b>90x90</b> 	116	BOOST	20 mm	Concrete Look	
	132	BOOST PRO	20 mm	Concrete Look	
	310	KLIF	20 mm	Stone Look	
<b>45x90</b> 	352	AXI	20 mm	Wood Look	
	296	BRAVE	20 mm	Stone Look	
	310	KLIF	20 mm	Stone Look	
	346	TRUST	20 mm	Stone Look	
	<b>60x90</b> 	276	AIX	20 mm	Stone Look
338		NORDE	20 mm	Stone Look	
<b>37,5x75</b> 	276	AIX	9 mm	Stone Look	
	198	BLAZE	9 mm	Metal Look	
<b>60x60</b> 	304	DOLMEN PRO	9 mm	Stone Look	
	310	KLIF	9 mm	Stone Look	
	324	LIMS	9 mm	Stone Look	
	172	RAW	9 mm	Concrete Look	
	276	AIX	20 mm	Stone Look	
	198	BLAZE	20 mm	Metal Look	
<b>30x60</b> 	116	BOOST	20 mm	Concrete Look	
	284	BOOST MIX	20 mm	Stone Look	
	132	BOOST PRO	20 mm	Concrete Look	
	124	BOOST NATURAL	9/20 mm	Concrete Look	
	290	BOOST STONE	9/20 mm	Stone Look	
	296	BRAVE	20 mm	Stone Look	
	304	DOLMEN PRO	20 mm	Stone Look	
	324	LIMS	20 mm	Stone Look	
	332	MARVEL STONE	20 mm	Stone Look	
	338	NORDE	9/20 mm	Stone Look	
	172	RAW	20 mm	Concrete Look	
	346	TRUST	20 mm	Stone Look	
<b>22,5x45,4</b> 	276	AIX	9/20 mm	Stone Look	
	304	DOLMEN PRO	9/20 mm	Stone Look	
<b>22,5x22,5</b> 	276	AIX	9/20 mm	Stone Look	
	304	DOLMEN PRO	9/20 mm	Stone Look	
<b>18,5x150</b> 	370	EXENCE	9 mm	Wood Look	
<b>30x120</b> 	364	ETIC PRO	20 mm	Wood Look	
	370	EXENCE	20 mm	Wood Look	
<b>22,5x90</b> 	352	AXI	9,5 mm	Wood Look	
	364	ETIC PRO	9 mm	Wood Look	



DOWNLOAD >  
OUTDOOR CATALOG

INDEX



PRODUCT  
FINDER



ALPHABETICAL INDEX  
LOOK INDEX  
PORCELAIN TILES SIZE INDEX  
WALL TILES SIZE INDEX  
OUTDOOR SURFACE INDEX

SURFACE  
RANGE



COMPANY



COLLECTIONS



LARGE SIZES



TECHNICAL  
SPECIFICATIONS





Porcelain Tiles  
Concrete &  
Resin Look

	<b>OFF WHITE</b> DWELL POLISHED, MATTE	<b>WHITE</b> RAW MATTE	<b>GYPSUM</b> MARK MATTE	<b>LIGHT</b> MEK MATTE	<b>COTTON</b> PRISM MATTE, SILK	<b>IVORY</b> BOOST PRO MATTE	<b>KAOLIN</b> BOOST NATURAL MATTE	<b>CORD</b> PRISM MATTE, SILK	<b>CREAM</b> BOOST PRO MATTE
<b>PEARL</b> RAW MATTE	<b>WHITE</b> BOOST MATTE	<b>PEARL</b> MARK MATTE	<b>PEARL</b> DWELL POLISHED, MATTE	<b>CLOUD</b> PRISM MATTE, SILK	<b>SAND</b> RAW MATTE	<b>ASH</b> BOOST NATURAL MATTE	<b>CLAY</b> BOOST PRO MATTE	<b>CLAY</b> MARK MATTE	<b>CORAL</b> BOOST NATURAL MATTE
<b>GREY</b> BOOST MATTE	<b>FOG</b> PRISM MATTE, SILK	<b>MEDIUM</b> MEK MATTE	<b>CHROME</b> MARK MATTE	<b>PEARL</b> BOOST MATTE	<b>ECRU</b> BOOST NATURAL MATTE	<b>GREIGE</b> DWELL POLISHED, MATTE	<b>TAUPE</b> BOOST PRO MATTE	<b>SUEDE</b> PRISM MATTE, SILK	<b>MUD</b> RAW MATTE
<b>GRAY</b> DWELL POLISHED, MATTE	<b>SMOKE</b> BOOST MATTE	<b>SMOKE</b> DWELL POLISHED, MATTE	<b>COAL</b> BOOST NATURAL MATTE	<b>GRAPHITE</b> MARK MATTE	<b>BROWN LEATHER</b> DWELL POLISHED, MATTE	<b>UMBER</b> BOOST NATURAL MATTE	<b>TOBACCO</b> BOOST PRO MATTE	<b>TOBACCO</b> MARK MATTE	<b>BRONZE</b> MEK MATTE
<b>TARMAC</b> BOOST MATTE	<b>GRAPHITE</b> PRISM MATTE, SILK	<b>DARK</b> MEK MATTE	<b>COBALT</b> BOOST NATURAL MATTE	<b>DUSK</b> PRISM MATTE	<b>MIDNIGHT</b> PRISM MATTE	<b>MOSS</b> PRISM MATTE	<b>EMERALD</b> PRISM MATTE	<b>CARAMEL</b> PRISM MATTE	<b>GRAPE</b> PRISM MATTE
<b>BLOOM</b> PRISM MATTE	Porcelain Tiles Metal Look	<b>ALUMINIUM</b> BLAZE POLISHED, MATTE	<b>CORTEN</b> BLAZE POLISHED, MATTE	<b>IRON</b> BLAZE POLISHED, MATTE					

Porcelain Tiles Range — CONCRETE & RESIN, METAL LOOK

Porcelain Tiles Range — CONCRETE & RESIN, METAL LOOK

INDEX 

PRODUCT FINDER 

SURFACE RANGE 

- PORCELAIN TILES
- OUTDOOR TILES
- WALL TILES
- PORCELAIN TILES DECORS
- WALL TILES DECORS

COMPANY 

COLLECTIONS 

LARGE SIZES 

TECHNICAL SPECIFICATIONS 

Porcelain Tiles  
Marble Look

MOON ONYX  
MARVEL  
POLISHED, MATTE

CARRARA PURE  
MARVEL STONE  
POLISHED, MATTE

CALACATTA EXTRA  
MARVEL  
POLISHED, MATTE

BIANCO DOLOMITE  
MARVEL STONE  
POLISHED, MATTE

CALACATTA DELICATO  
MARVEL SHINE  
POLISHED, MATTE, SILK

CALACATTA PRESTIGIO  
MARVEL SHINE  
POLISHED, MATTE, SILK

CALACATTA IMPERIALE  
MARVEL SHINE  
POLISHED, MATTE, SILK

CHAMPAGNE ONYX  
MARVEL  
POLISHED, MATTE

ROYAL CALACATTA  
MARVEL EDGE  
POLISHED, MATTE

STATUARIO SELECT  
MARVEL PRO  
POLISHED, MATTE

STATUARIO SUPREMO  
MARVEL SHINE  
POLISHED, MATTE, SILK

BARDIGLIO GREY  
MARVEL STONE  
POLISHED, MATTE

GREY FLEURY  
MARVEL PRO  
POLISHED, MATTE

AGATA AZUL  
MARVEL EDGE  
POLISHED

CREMO DELICATO  
MARVEL PRO  
POLISHED, MATTE

BIANCO FANTASTICO  
MARVEL DREAM  
POLISHED, MATTE

IMPERIAL WHITE  
MARVEL EDGE  
POLISHED, MATTE

CREAM PRESTIGE  
MARVEL STONE  
POLISHED, MATTE

BEIGE MYSTERY  
MARVEL  
POLISHED, MATTE

GREY STONE  
MARVEL  
POLISHED, MATTE

MORNING SKY  
MARVEL DREAM  
POLISHED, MATTE

GRIGIO INTENSO  
MARVEL DREAM  
POLISHED, MATTE

NOIR ST. LAURENT  
MARVEL PRO  
POLISHED, MATTE

NERO MARQUINA  
MARVEL STONE  
POLISHED, MATTE

TRAVERTINO ALABASTRINO  
MARVEL PRO  
POLISHED, MATTE

GOLD ONYX  
MARVEL EDGE  
POLISHED

ELEGANT SABLE  
MARVEL EDGE  
POLISHED, MATTE

TRAVERTINO SILVER  
MARVEL PRO  
POLISHED, MATTE

GRIS SUPREME  
MARVEL EDGE  
POLISHED, MATTE

BLACK ATLANTIS  
MARVEL DREAM  
POLISHED, MATTE

RED LUXURY  
MARVEL EDGE  
POLISHED

CRYSTAL BEAUTY  
MARVEL DREAM  
POLISHED

BRAZIL GREEN  
MARVEL DREAM  
POLISHED

ULTRAMARINE  
MARVEL DREAM  
POLISHED

ABSOLUTE BROWN  
MARVEL EDGE  
POLISHED, MATTE

BRONZE LUXURY  
MARVEL  
POLISHED, MATTE

TERRAZZO CREAM  
MARVEL GEMS  
MATTE

TERRAZZO WHITE  
MARVEL GEMS  
MATTE

TERRAZZO PEARL  
MARVEL GEMS  
MATTE

TERRAZZO GREY  
MARVEL GEMS  
MATTE

TERRAZZO BLACK  
MARVEL GEMS  
MATTE

Porcelain Tiles Range — MARBLE LOOK

Porcelain Tiles Range — MARBLE LOOK

INDEX



PRODUCT  
FINDER



SURFACE  
RANGE



- PORCELAIN TILES
- OUTDOOR TILES
- WALL TILES
- PORCELAIN TILES DECORS
- WALL TILES DECORS

COMPANY



COLLECTIONS



LARGE SIZES



TECHNICAL  
SPECIFICATIONS



Porcelain Tiles  
Stone Look

	<b>WHITE</b> BOOST STONE MATTE	<b>MOON</b> TRUST MATTE	<b>GYPSUM</b> BRAVE MATTE	<b>WHITE</b> KLIF MATTE	<b>IVORY</b> BOOST MIX MATTE	<b>IVORY</b> LIMS MATTE	<b>IVORY</b> BOOST STONE MATTE	<b>WHITE</b> KONE MATTE	<b>CREAM</b> BOOST STONE MATTE	
	<b>PEARL</b> BOOST MIX MATTE	<b>CLAUZETTO WHITE</b> MARVEL STONE MATTE	<b>SILVER</b> KONE MATTE	<b>PEARL</b> BOOST STONE MATTE	<b>SILVER</b> KLIF MATTE	<b>BEIGE</b> LIMS MATTE	<b>MAGNESIO</b> NORDE MATTE	<b>BEIGE</b> KONE MATTE	<b>IVORY</b> TRUST MATTE	<b>PLATINO</b> NORDE MATTE
	<b>MIX</b> KONE MATTE	<b>CENERE</b> DOLMEN PRO MATTE	<b>GREY</b> BOOST STONE MATTE	<b>PEARL</b> BRAVE MATTE	<b>PEARL</b> KONE MATTE	<b>GREY</b> LIMS MATTE	<b>BLANC</b> AIX MATTE	<b>ORO</b> NORDE MATTE	<b>DESERT</b> LIMS MATTE	<b>GOLD</b> TRUST MATTE
	<b>SILVER</b> TRUST MATTE	<b>SMOKE</b> BOOST STONE MATTE	<b>GREY</b> KLIF MATTE	<b>PIOMBO</b> NORDE MATTE	<b>GRIGIO</b> DOLMEN PRO MATTE	<b>BEIGE</b> AIX MATTE	<b>DESERT BEIGE</b> MARVEL STONE MATTE	<b>CLAY</b> BOOST STONE MATTE	<b>CENDRE</b> AIX MATTE	<b>TAUPE</b> BOOST STONE MATTE
	<b>GREY</b> KONE MATTE	<b>GREY</b> BRAVE MATTE	<b>CARDOSO ELEGANT</b> MARVEL STONE MATTE	<b>SMOKE</b> BOOST MIX MATTE	<b>TARMAC</b> BOOST STONE MATTE	<b>COPPER</b> TRUST MATTE	<b>EARTH</b> BRAVE MATTE	<b>TOBACCO</b> BOOST STONE MATTE	<b>MIX</b> DOLMEN PRO MATTE	<b>ROSSO</b> DOLMEN PRO MATTE
	<b>TITANIUM</b> TRUST MATTE	<b>BASALTINA VOLCANO</b> MARVEL STONE MATTE	<b>FUMÉE</b> AIX MATTE	<b>COKE</b> BRAVE MATTE	<b>DARK</b> KLIF MATTE					

Porcelain Tiles Range — STONE LOOK

Porcelain Tiles Range — STONE LOOK

INDEX



PRODUCT  
FINDER



SURFACE  
RANGE



- PORCELAIN TILES
- OUTDOOR TILES
- WALL TILES
- PORCELAIN TILES DECORS
- WALL TILES DECORS

COMPANY



COLLECTIONS



LARGE SIZES



TECHNICAL  
SPECIFICATIONS





Porcelain Tiles  
Wood Look



LIGHT  
NID  
MATTE



VANILLA  
EXENCE  
MATTE



VANILLA SAW CUT  
EXENCE  
MATTE

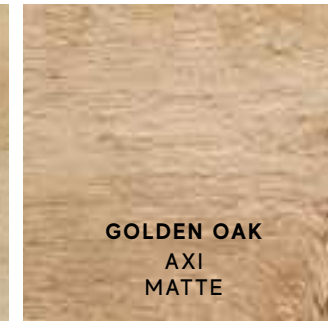

GOLDEN OAK  
AXI  
MATTE

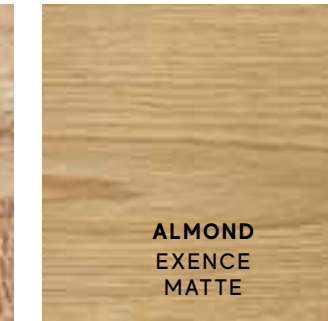

ALMOND  
EXENCE  
MATTE



ALMOND SAW CUT  
EXENCE  
MATTE



MALT  
HEARTWOOD  
MATTE



AMBER  
EXENCE  
MATTE

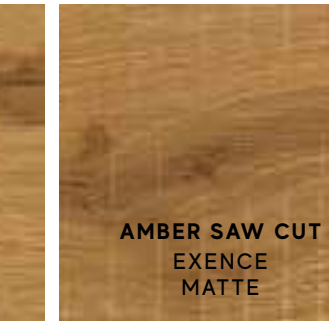

AMBER SAW CUT  
EXENCE  
MATTE



NATURAL  
NID  
MATTE



ROVERE  
ETIC  
MATTE



CASHMERE  
NID  
MATTE



ROVERE VENICE  
ETIC PRO  
MATTE



WHISKY  
NID  
MATTE



NOCE  
ETIC  
MATTE



BROWN CHESTNUT  
AXI  
MATTE

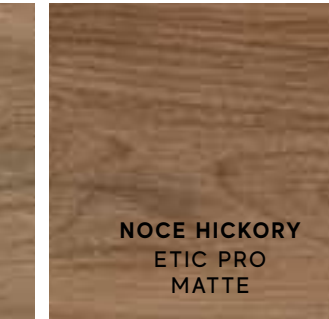

NOCE HICKORY  
ETIC PRO  
MATTE



DARK OAK  
AXI  
MATTE



BRANDY  
HEARTWOOD  
MATTE

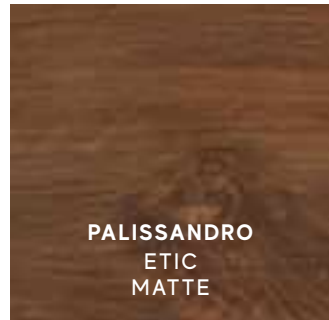

PALISSANDRO  
ETIC  
MATTE

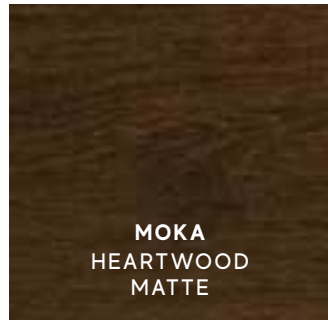

MOKA  
HEARTWOOD  
MATTE



ROVERE BIANCO  
ETIC  
MATTE



WHITE PINE  
AXI  
MATTE



ROVERE GRIGIO  
ETIC  
MATTE



SILVER FIR  
AXI  
MATTE



GREY TIMBER  
AXI  
MATTE

Porcelain Tiles Range — WOOD LOOK

Porcelain Tiles Range — WOOD LOOK

INDEX



PRODUCT  
FINDER



SURFACE  
RANGE



PORCELAIN TILES

OUTDOOR TILES

WALL TILES

PORCELAIN TILES DECORS

WALL TILES DECORS

COMPANY



COLLECTIONS



LARGE SIZES



TECHNICAL  
SPECIFICATIONS





Outdoor Range — CONCRETE & RESIN LOOK

<p><b>Outdoor Tiles Concrete &amp; Resin Look</b></p> <p><b>TEXTURED &amp; GRIP</b> ✂ 9 mm</p> <p><b>OUTDOOR</b> ✂ 20 mm</p>	<p><b>WHITE RAW</b> GRIP, OUTDOOR</p>	<p><b>WHITE BOOST</b> GRIP, OUTDOOR</p>	<p><b>PEARL RAW</b> GRIP, OUTDOOR</p>	<p><b>CLOUD PRISM</b> GRIP, OUTDOOR</p>
<p><b>PEARL BOOST</b> GRIP</p>	<p><b>GREY BOOST</b> GRIP, OUTDOOR</p>	<p><b>FOG PRISM</b> GRIP, OUTDOOR</p>	<p><b>SMOKE BOOST</b> GRIP, OUTDOOR</p>	<p><b>COAL BOOST NATURAL</b> GRIP</p>
<p><b>TARMAC BOOST</b> GRIP, OUTDOOR</p>	<p><b>TOBACCO BOOST PRO</b> GRIP, OUTDOOR</p>	<p><b>UMBER BOOST NATURAL</b> GRIP</p>	<p><b>MUD RAW</b> GRIP, OUTDOOR</p>	<p><b>TAUPE BOOST PRO</b> GRIP, OUTDOOR</p>
<p><b>SUEDE PRISM</b> GRIP, OUTDOOR</p>	<p><b>ECRU BOOST NATURAL</b> GRIP, OUTDOOR</p>	<p><b>CLAY BOOST PRO</b> GRIP, OUTDOOR</p>	<p><b>SAND RAW</b> GRIP, OUTDOOR</p>	<p><b>ASH BOOST NATURAL</b> GRIP, OUTDOOR</p>
<p><b>CREAM BOOST PRO</b> GRIP, OUTDOOR</p>	<p><b>CORD PRISM</b> GRIP, OUTDOOR</p>	<p><b>KAOLIN BOOST NATURAL</b> GRIP, OUTDOOR</p>	<p><b>IVORY BOOST PRO</b> GRIP</p>	

<p><b>Outdoor Tiles Metal Look</b></p> <p><b>TEXTURED &amp; GRIP</b> ✂ 9 mm</p> <p><b>OUTDOOR</b> ✂ 20 mm</p>	<p><b>ALUMINIUM BLAZE</b> GRIP</p>	<p><b>CORTEN BLAZE</b> GRIP, OUTDOOR</p>	<p><b>IRON BLAZE</b> GRIP</p>	
<p><b>Outdoor Tiles Marble Look</b></p> <p><b>TEXTURED</b> ✂ 9 mm</p>	<p><b>CREMO DELICATO MARVEL PRO</b> TEXTURED</p>	<p><b>STATUARIO SELECT MARVEL PRO</b> TEXTURED</p>	<p><b>GREY FLEURY MARVEL PRO</b> TEXTURED</p>	
<p><b>Outdoor Tiles Wood Look</b></p> <p><b>TEXTURED &amp; GRIP</b> ✂ 9/9,5 mm</p> <p><b>OUTDOOR</b> ✂ 20 mm</p>	<p><b>WHITE PINE AXI</b> TEXTURED, OUTDOOR</p>	<p><b>VANILLA EXENCE</b> GRIP</p>	<p><b>GOLDEN OAK AXI</b> TEXTURED, OUTDOOR</p>	<p><b>ROVERE VENICE ETIC PRO</b> GRIP, OUTDOOR</p>
<p><b>ALMOND EXENCE</b> GRIP, OUTDOOR</p>	<p><b>AMBER EXENCE</b> GRIP, OUTDOOR</p>	<p><b>BROWN CHESTNUT AXI</b> TEXTURED, OUTDOOR</p>	<p><b>NOCE HICKORY ETIC PRO</b> GRIP, OUTDOOR</p>	<p><b>DARK OAK AXI</b> TEXTURED</p>
<p><b>SILVER FIR AXI</b> TEXTURED</p>	<p><b>GREY TIMBER AXI</b> TEXTURED, OUTDOOR</p>			

Outdoor Range — METAL, MARBLE, WOOD LOOK

INDEX 

PRODUCT FINDER 

**SURFACE RANGE** 

- PORCELAIN TILES
- OUTDOOR TILES
- WALL TILES
- PORCELAIN TILES DECORS
- WALL TILES DECORS

COMPANY 

COLLECTIONS 

LARGE SIZES 

TECHNICAL SPECIFICATIONS 

**Outdoor Tiles**  
**Stone Look**  
TEXTURED & GRIP  
± 9 mm  
OUTDOOR  
± 20 / 30 mm

	<b>WHITE</b> BOOST STONE GRIP, OUTDOOR	<b>WHITE</b> KONE GRIP	<b>MOON</b> TRUST GRIP	<b>GYPSUM</b> BRAVE GRIP, OUTDOOR	<b>IVORY</b> BOOST MIX GRIP, OUTDOOR	<b>IVORY</b> LIMS GRIP, OUTDOOR	<b>IVORY</b> BOOST STONE GRIP	<b>BEIGE</b> KONE GRIP	<b>BEIGE</b> LIMS GRIP, OUTDOOR	
	<b>WHITE</b> KLIF GRIP	<b>PEARL</b> BOOST MIX GRIP, OUTDOOR	<b>CLAUZETTO WHITE</b> MARVEL STONE TEXTURED	<b>PEARL</b> BOOST STONE GRIP	<b>SILVER</b> KONE GRIP	<b>MAGNESIO</b> NORDE ROCCIA	<b>MAGNESIO</b> NORDE GRIP, OUTDOOR	<b>CREAM</b> BOOST STONE GRIP, OUTDOOR	<b>GREY</b> LIMS GRIP, OUTDOOR	<b>IVORY</b> TRUST GRIP, OUTDOOR
	<b>SILVER</b> KLIF GRIP, OUTDOOR	<b>CENERE</b> DOLMEN PRO GRIP, TEXTURED OUTDOOR	<b>GREY</b> BOOST STONE GRIP, OUTDOOR	<b>PEARL</b> BRAVE GRIP, OUTDOOR	<b>PEARL</b> KONE GRIP	<b>PLATINO</b> NORDE ROCCIA	<b>PLATINO</b> NORDE GRIP, OUTDOOR	<b>BLANC</b> AIX GRIP, OUTDOOR	<b>ORO</b> NORDE ROCCIA	<b>ORO</b> NORDE GRIP, OUTDOOR
	<b>SILVER</b> TRUST GRIP, OUTDOOR	<b>SMOKE</b> BOOST STONE GRIP, OUTDOOR	<b>GREY</b> KLIF GRIP, OUTDOOR	<b>PIOMBO</b> NORDE ROCCIA	<b>PIOMBO</b> NORDE GRIP, OUTDOOR	<b>DESERT</b> LIMS GRIP, OUTDOOR	<b>GOLD</b> TRUST GRIP, OUTDOOR	<b>BEIGE</b> AIX GRIP, TEXTURED OUTDOOR	<b>DESERT BEIGE</b> MARVEL STONE TEXTURED	<b>CLAY</b> BOOST STONE GRIP, OUTDOOR
	<b>GRIGIO</b> DOLMEN PRO GRIP, TEXTURED OUTDOOR	<b>GREY</b> KONE GRIP	<b>GREY</b> BRAVE GRIP, OUTDOOR	<b>CARDOSO ELEGANT</b> MARVEL STONE TEXTURED, OUTDOOR	<b>COPPER</b> TRUST GRIP	<b>CENDRE</b> AIX GRIP, TEXTURED OUTDOOR	<b>TAUPE</b> BOOST STONE GRIP	<b>MIX</b> DOLMEN PRO GRIP, TEXTURED OUTDOOR	<b>ROSSO</b> DOLMEN PRO GRIP, TEXTURED OUTDOOR	<b>TOBACCO</b> BOOST STONE GRIP
	<b>EARTH</b> BRAVE GRIP, OUTDOOR	<b>TITANIUM</b> TRUST GRIP, OUTDOOR	<b>BASALTINA VOLCANO</b> MARVEL STONE TEXTURED, OUTDOOR	<b>SMOKE</b> BOOST MIX GRIP, OUTDOOR	<b>TARMAC</b> BOOST STONE GRIP, OUTDOOR	<b>FUMÉE</b> AIX GRIP, OUTDOOR	<b>COKE</b> BRAVE GRIP, OUTDOOR	<b>DARK</b> KLIF GRIP, OUTDOOR		

Outdoor Range — STONE LOOK

Outdoor Range — STONE LOOK

INDEX



PRODUCT  
FINDER



SURFACE  
RANGE



- PORCELAIN TILES
- OUTDOOR TILES
- WALL TILES
- PORCELAIN TILES DECORS
- WALL TILES DECORS

COMPANY



COLLECTIONS



LARGE SIZES



TECHNICAL  
SPECIFICATIONS



Wall Tiles  
Concrete &  
Resin Look

	OFF WHITE DWELL SHINY	LIGHT MEK MATTE	ICE DWELL SHINY	WHITE MINIDOTS APLOMB MATTE	SUGAR ARTY MATTE	COTTON PRISM MATTE	IVORY BOOST PRO MATTE	CREAM MINIDOTS APLOMB MATTE	CREAM STRIPES APLOMB MATTE
WHITE STRIPES APLOMB MATTE	MILK ARTY MATTE	WHITE RAW MATTE	WHITE BOOST MATTE	PEARL RAW MATTE	KAOLIN BOOST NATURAL MATTE	CORD PRISM MATTE	CANVAS STRIPES APLOMB MATTE	CANVAS MINIDOTS APLOMB MATTE	ASH BOOST NATURAL MATTE
MEDIUM MEK MATTE	CLOUD PRISM MATTE	SILVER DWELL SHINY	PEARL BOOST MATTE	GREY BOOST MATTE	SAND RAW MATTE	CREAM BOOST PRO MATTE	MALT ARTY MATTE	CLAY BOOST PRO MATTE	ECRU BOOST NATURAL MATTE
CHARCOAL ARTY MATTE	SMOKE BOOST MATTE	GRAPHITE PRISM MATTE	3D URBAN GREY BOOST MATTE	3D URBAN PEARL BOOST MATTE	SUEDE PRISM MATTE	3D BRUSHED ECRU BOOST NATURAL MATTE	3D TEXTURE ECRU BOOST NATURAL MATTE	3D WAVE ECRU BOOST NATURAL MATTE	3D URBAN CLAY BOOST PRO MATTE
3D SCRATCH PEARL RAW MATTE	3D FOLD MEDIUM MEK MATTE	3D FOLD LIGHT MEK MATTE	3D URBAN WHITE BOOST MATTE	3D SCRATCH WHITE RAW MATTE	3D BRUSHED ASH BOOST NATURAL MATTE	3D TEXTURE ASH BOOST NATURAL MATTE	3D WAVE ASH BOOST NATURAL MATTE	3D BRUSHED KAOLIN BOOST NATURAL MATTE	3D TEXTURE KAOLIN BOOST NATURAL MATTE
Wall Tiles Metal Look	ALUMINIUM BLAZE MATTE	CORTEN BLAZE MATTE	IRON BLAZE MATTE			3D WAVE KAOLIN BOOST NATURAL MATTE	3D URBAN IVORY BOOST PRO MATTE		

Wall Tiles Range — CONCRETE & RESIN, METAL LOOK

Wall Tiles Range — CONCRETE & RESIN, METAL LOOK

INDEX



PRODUCT  
FINDER



SURFACE  
RANGE



- PORCELAIN TILES
- OUTDOOR TILES
- WALL TILES
- PORCELAIN TILES DECORS
- WALL TILES DECORS

COMPANY



COLLECTIONS



LARGE SIZES



TECHNICAL  
SPECIFICATIONS



Wall Tiles  
Marble Look



MOON ONYX  
MARVEL  
SHINY

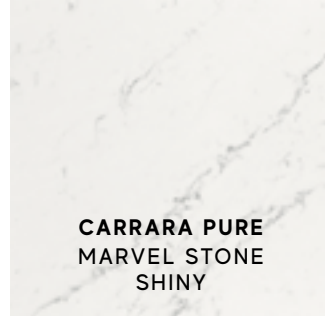

CARRARA PURE  
MARVEL STONE  
SHINY



BIANCO DOLOMITE  
MARVEL STONE  
SHINY



CALACATTA EXTRA  
MARVEL  
SHINY



CALACATTA DELICATO  
MARVEL SHINE  
SHINY, SILK



CALACATTA PRESTIGIO  
MARVEL SHINE  
SHINY, SILK



CALACATTA IMPERIALE  
MARVEL SHINE  
SHINY, SILK



CHAMPAGNE ONYX  
MARVEL  
SHINY

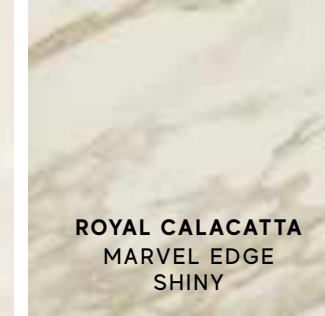

ROYAL CALACATTA  
MARVEL EDGE  
SHINY



STATUARIO SELECT  
MARVEL PRO  
SHINY



STATUARIO SUPREMO  
MARVEL SHINE  
SHINY, SILK



BARDIGLIO GREY  
MARVEL STONE  
SHINY



GREY FLEURY  
MARVEL PRO  
SHINY



TRAVERTINO SILVER  
MARVEL PRO  
SHINY



CREMO DELICATO  
MARVEL PRO  
SHINY

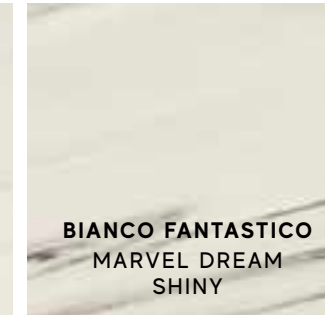

BIANCO FANTASTICO  
MARVEL DREAM  
SHINY



IMPERIAL WHITE  
MARVEL EDGE  
SHINY

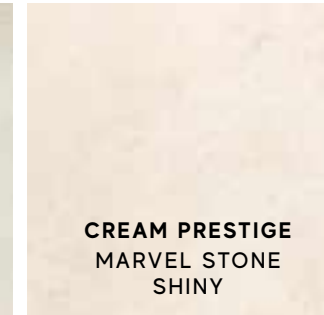

CREAM PRESTIGE  
MARVEL STONE  
SHINY



BEIGE MYSTERY  
MARVEL  
SHINY

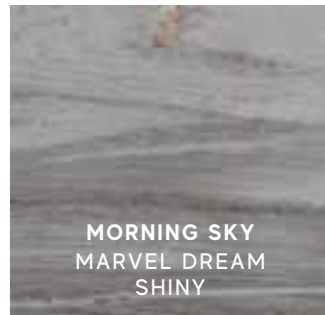

MORNING SKY  
MARVEL DREAM  
SHINY



GRIGIO INTENSO  
MARVEL DREAM  
SHINY



NOIR ST. LAURENT  
MARVEL PRO  
SHINY



NERO MARQUINA  
MARVEL STONE  
SHINY



BLACK ATLANTIS  
MARVEL DREAM  
SHINY

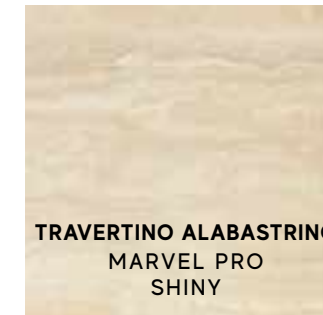

TRAVERTINO ALABASTRINO  
MARVEL PRO  
SHINY



ELEGANT SABLE  
MARVEL EDGE  
SHINY



GRIS CLAIR  
MARVEL EDGE  
SHINY



SILVER DREAM  
MARVEL  
SHINY

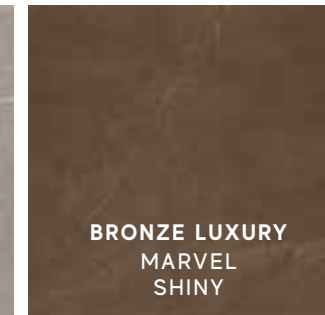

BRONZE LUXURY  
MARVEL  
SHINY



BRAZIL GREEN  
MARVEL DREAM  
SHINY

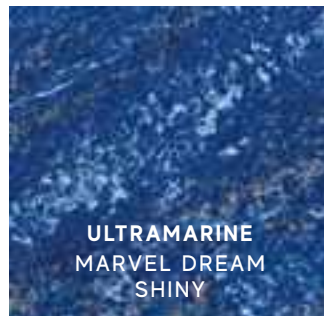

ULTRAMARINE  
MARVEL DREAM  
SHINY

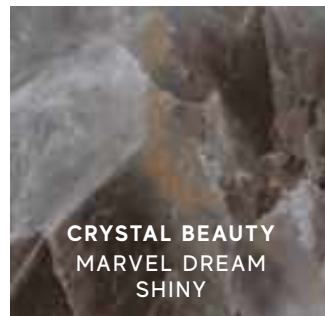

CRYSTAL BEAUTY  
MARVEL DREAM  
SHINY

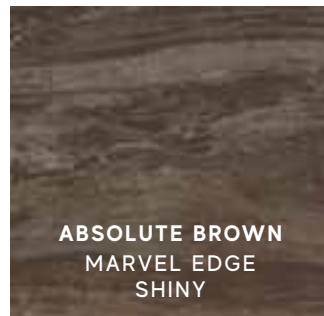

ABSOLUTE BROWN  
MARVEL EDGE  
SHINY

Wall Tiles Range — MARBLE LOOK

Wall Tiles Range — MARBLE LOOK

INDEX



PRODUCT  
FINDER



SURFACE  
RANGE



PORCELAIN TILES  
OUTDOOR TILES

WALL TILES

PORCELAIN TILES DECORS

WALL TILES DECORS

COMPANY



COLLECTIONS



LARGE SIZES



TECHNICAL  
SPECIFICATIONS



Wall Tiles  
Stone Look

Wall Tiles  
Color Look

INDEX



PRODUCT  
FINDER



SURFACE  
RANGE



- PORCELAIN TILES
- OUTDOOR TILES
- WALL TILES
- PORCELAIN TILES DECORS
- WALL TILES DECORS

COMPANY



COLLECTIONS



LARGE SIZES



TECHNICAL  
SPECIFICATIONS



Wall Tiles Range — STONE, COLOR LOOK

Wall Tiles Range — STONE, COLOR LOOK

Wall Tiles  
3D Wall

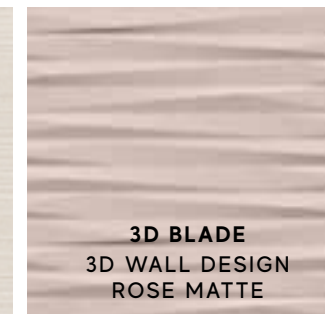
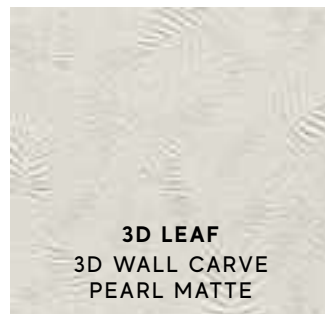
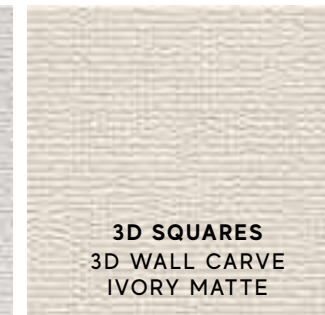
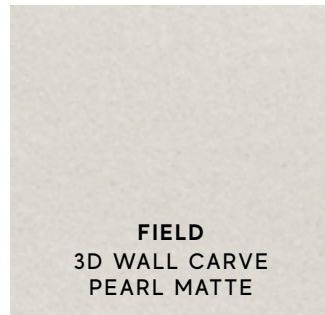
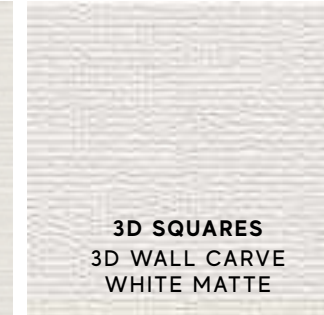

Wall Tiles Range — 3D WALL

Wall Tiles Range — 3D WALL

INDEX



PRODUCT  
FINDER



SURFACE  
RANGE



- PORCELAIN TILES
- OUTDOOR TILES
- WALL TILES
- PORCELAIN TILES DECORS
- WALL TILES DECORS

COMPANY



COLLECTIONS



LARGE SIZES



TECHNICAL  
SPECIFICATIONS



Porcelain Tile Decors  
Concrete & Resin Look

Porcelain Tile Decors Range — CONCRETE & RESIN LOOK

Porcelain Tile Decors Range — CONCRETE & RESIN LOOK

INDEX



PRODUCT FINDER



SURFACE RANGE



- PORCELAIN TILES
- OUTDOOR TILES
- WALL TILES
- PORCELAIN TILES DECORS
- WALL TILES DECORS

COMPANY



COLLECTIONS



LARGE SIZES



TECHNICAL SPECIFICATIONS





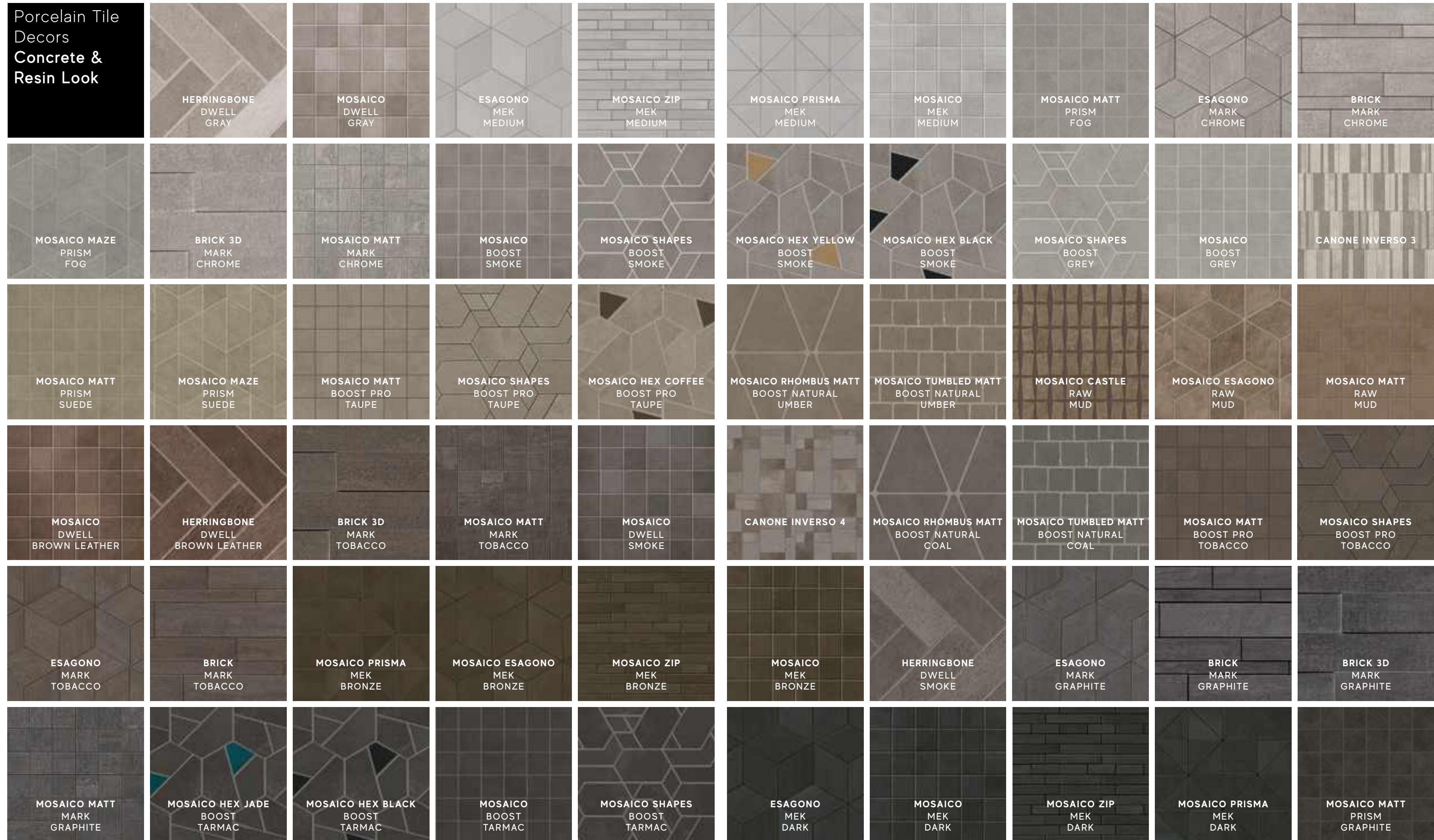

Porcelain Tile Decors Range — CONCRETE & RESIN LOOK

Porcelain Tile Decors Range — CONCRETE & RESIN LOOK

- INDEX ☰
- PRODUCT FINDER ➤
- SURFACE RANGE ➤
  - PORCELAIN TILES
  - OUTDOOR TILES
  - WALL TILES
  - PORCELAIN TILES DECORS
  - WALL TILES DECORS
- COMPANY ➤
- COLLECTIONS ➤
- LARGE SIZES ➤
- TECHNICAL SPECIFICATIONS ➤

**Porcelain Tile Decors Concrete & Resin Look**

MOSAICO MAZE PRISM GRAPHITE

MOSAICO RHOMBUS MATT BOOST NATURAL COBALT

MOSAICO TUMBLED MATT BOOST NATURAL COBALT

**Porcelain Tile Decors Concrete & Resin Look 20x20 cm**

WARM VENTI BOOST MATTE

MIX WARM VENTI BOOST MATTE

CARPET 1 WARM VENTI BOOST MATTE

CARPET 2 WARM VENTI BOOST MATTE

CARPET 3 WARM VENTI BOOST MATTE

COLD VENTI BOOST MATTE

MIX COLD VENTI BOOST MATTE

CARPET 1 COLD VENTI BOOST MATTE

CARPET 2 COLD VENTI BOOST MATTE

CARPET 3 COLD VENTI BOOST MATTE

CLASSIC MIX VENTI BOOST MATTE

CLASSIC CARPET 1 VENTI BOOST MATTE

CLASSIC CARPET 2 VENTI BOOST MATTE

CLASSIC CARPET 3 VENTI BOOST MATTE

BLUE MIX VENTI BOOST MATTE

BLUE CARPET 1 VENTI BOOST MATTE

BLUE CARPET 2 VENTI BOOST MATTE

BLUE CARPET 3 VENTI BOOST MATTE

**Porcelain Tile Decors Large Sizes**

GRADIENT PRISM

BRUSH PRISM

PAINT BOOST PRO

LEAVES BOOST PRO

GROVE BOOST PRO

**Porcelain Tile Decors Metal Look**

MOSAICO 3D FACTORY BLAZE ALUMINIUM

MOSAICO ESAGONO MATT BLAZE ALUMINIUM

MOSAICO BLAZE ALUMINIUM

MOSAICO ESAGONO LAPPATO BLAZE ALUMINIUM

MOSAICO TWIN BLAZE ALUMINIUM

MOSAICO 3D FACTORY BLAZE CORTEN

MOSAICO ESAGONO MATT BLAZE CORTEN

MOSAICO BLAZE CORTEN

MOSAICO ESAGONO LAPPATO BLAZE CORTEN

MOSAICO TWIN BLAZE ALUMINIUM

MOSAICO 3D FACTORY BLAZE CORTEN

MOSAICO ESAGONO MATT BLAZE CORTEN

MOSAICO BLAZE CORTEN

MOSAICO ESAGONO LAPPATO BLAZE CORTEN

MOSAICO TWIN BLAZE CORTEN

MOSAICO ESAGONO MATT BLAZE IRON

MOSAICO TWIN BLAZE IRON

MOSAICO BLAZE IRON

MOSAICO ESAGONO LAPPATO BLAZE IRON

MOSAICO 3D FACTORY BLAZE IRON

INDEX 

PRODUCT FINDER 

SURFACE RANGE 

- PORCELAIN TILES
- OUTDOOR TILES
- WALL TILES
- PORCELAIN TILES DECORS
- WALL TILES DECORS

COMPANY 

COLLECTIONS 

LARGE SIZES 

TECHNICAL SPECIFICATIONS 

Porcelain Tile Decors Range — CONCRETE & RESIN, METAL LOOK

Porcelain Tile Decors Range — CONCRETE & RESIN, METAL LOOK

Porcelain Tile Decors  
Marble Look

Porcelain Tile Decors Range — MARBLE LOOK

Porcelain Tile Decors Range — MARBLE LOOK

INDEX



PRODUCT  
FINDER



SURFACE  
RANGE



- PORCELAIN TILES
- OUTDOOR TILES
- WALL TILES
- PORCELAIN TILES DECORS
- WALL TILES DECORS

COMPANY



COLLECTIONS



LARGE SIZES



TECHNICAL  
SPECIFICATIONS



Porcelain Tile Decors  
Marble Look

MOSAICO TWILL LAPPATO MARVEL EDGE IMPERIAL WHITE	MOSAICO MATT MARVEL STONE CREAM PRESTIGE	BASKETWEAVE WARM LAPPATO MARVEL STONE CARRARA PURE + NERO MARQUINA	MOSAICO ESAGONO 3D MARVEL STONE CREAM PRESTIGE	MOSAICO LAPPATO MARVEL BEIGE MYSTERY	BASKETWEAVE WARM LAPPATO MARVEL STONE CREAM PRESTIGE	MOSAICO LAPPATO MARVEL STONE CREAM PRESTIGE	MOSAICO ESAGONO LAPPATO MARVEL STONE CREAM PRESTIGE	CHEVRON LAPPATO MARVEL STONE CREAM PRESTIGE	
MOSAICO CUBES LAPPATO MARVEL EDGE GRIS CLAIR + ROYAL CALACATTA	MOSAICO LAPPATO MARVEL PRO TRAVERTINO ALABASTRINO	MOSAICO ESAGONO LAPPATO MARVEL PRO TRAVERTINO ALABASTRINO	MOSAICO 3D MARVEL PRO TRAVERTINO ALABASTRINO	MOSAICO ESAGONO GEO WARM LAPPATO MARVEL STONE	MOSAICO MATT MARVEL PRO TRAVERTINO ALABASTRINO	MOSAICO MATT MARVEL BEIGE MYSTERY	MOSAICO 3D MARVEL BEIGE MYSTERY	MOSAICO LAPPATO MARVEL EDGE GOLD ONYX	MOSAICO ESAGONO MULTICOLOR WARM MARVEL PRO
MOSAICO LAPPATO MARVEL EDGE ELEGANT SABLE	MOSAICO MATT MARVEL EDGE ELEGANT SABLE	MOSAICO TWILL LAPPATO MARVEL EDGE ELEGANT SABLE	MOSAICO ESAGONO LAPPATO MARVEL EDGE ELEGANT SABLE	MOSAICO 3D MARVEL EDGE ELEGANT SABLE	MOSAICO LAPPATO MARVEL EDGE AGATA AZUL	MOSAICO MATT MARVEL EDGE GRIS SUPREME	MOSAICO TWILL LAPPATO MARVEL EDGE GRIS SUPREME	MOSAICO ESAGONO LAPPATO MARVEL EDGE GRIS SUPREME	MOSAICO 3D MARVEL EDGE GRIS SUPREME
MOSAICO LAPPATO MARVEL EDGE GRIS SUPREME	MOSAICO LAPPATO MARVEL BRONZE LUXURY	MOSAICO MATT MARVEL BRONZE LUXURY	GRECA MOSAICO MARVEL BRONZE LUXURY + CHAMPAGNE ONYX	MOSAICO MATCH LAPPATO MARVEL SHINE CALACATTA DELICATO + CALACATTA PRESTIGIO + BLAZE CORTEN + BOOST PRO TOBACCO	MOSAICO LAPPATO MARVEL DREAM BRAZIL GREEN	MOSAICO LIBERTY LAPPATO MARVEL DREAM BRAZIL GREEN	MOSAICO LEAF LAPPATO MARVEL DREAM BRAZIL GREEN	MOSAICO 3D MARVEL BRONZE LUXURY	MOSAICO TWILL LAPPATO MARVEL EDGE ABSOLUTE BROWN
MOSAICO LAPPATO MARVEL EDGE ABSOLUTE BROWN	MOSAICO ESAGONO LAPPATO MARVEL EDGE ABSOLUTE BROWN	MOSAICO MATT MARVEL EDGE ABSOLUTE BROWN	MOSAICO 3D MARVEL EDGE ABSOLUTE BROWN	MOSAICO LIBERTY LAPPATO MARVEL DREAM CRYSTAL BEAUTY	MOSAICO LEAF LAPPATO MARVEL DREAM CRYSTAL BEAUTY	MOSAICO LAPPATO MARVEL DREAM CRYSTAL BEAUTY	MOSAICO LAPPATO MARVEL EDGE RED LUXURY	MOSAICO LAPPATO MARVEL STONE NERO MARQUINA	MOSAICO LAPPATO BURATTATO MARVEL STONE NERO MARQUINA
MOSAICO MATT MARVEL STONE NERO MARQUINA	MOSAICO STAR LAPPATO MARVEL DREAM GRIGIO INTENSO + CRYSTAL BEAUTY + BLACK ATLANTIS	MOSAICO ESAGONO LAPPATO MARVEL STONE NERO MARQUINA	CHEVRON LAPPATO MARVEL STONE NERO MARQUINA	MOSAICO LAPPATO MARVEL DREAM BLACK ATLANTIS	MOSAICO HONEYCOMB COLD LAPPATO MARVEL PRO STATUARIO SELECT + NOIR ST. LAURENT	CHEVRON COLD LAPPATO MARVEL STONE CARRARA PURE + NERO MARQUINA	HALF HEX COLD LAPPATO MARVEL STONE CARRARA PURE + NERO MARQUINA	MOSAICO ESAGONO GEO COLD LAPPATO MARVEL STONE	MOSAICO ESAGONO MULTICOLOR COLD MARVEL PRO

Porcelain Tile Decors Range — MARBLE LOOK

Porcelain Tile Decors Range — MARBLE LOOK

- INDEX ☰
- PRODUCT FINDER ➤
- SURFACE RANGE ➤
  - PORCELAIN TILES
  - OUTDOOR TILES
  - WALL TILES
  - PORCELAIN TILES DECORS
  - WALL TILES DECORS
- COMPANY ➤
- COLLECTIONS ➤
- LARGE SIZES ➤
- TECHNICAL SPECIFICATIONS ➤

Porcelain Tile Decors  
Marble Look

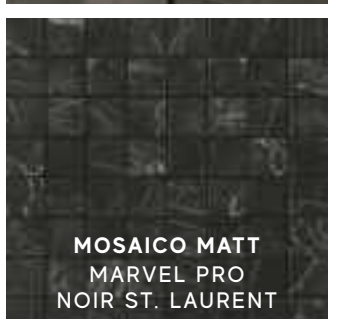
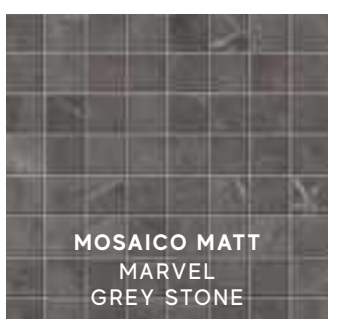
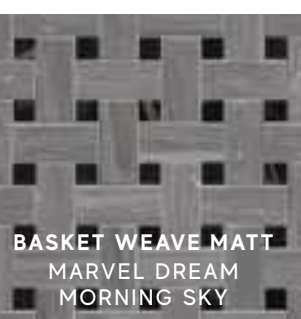
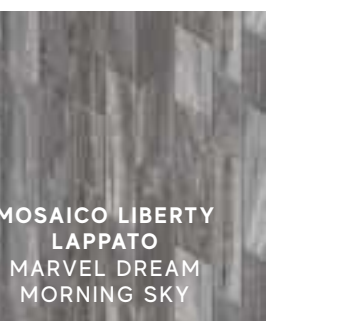
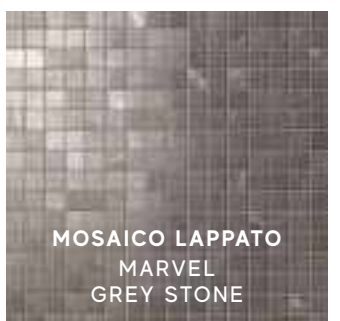

Porcelain Tile Decors Range — MARBLE LOOK

Porcelain Tile Decors Range — MARBLE LOOK

INDEX



PRODUCT FINDER



SURFACE RANGE



- PORCELAIN TILES
- OUTDOOR TILES
- WALL TILES
- PORCELAIN TILES DECORS
- WALL TILES DECORS

COMPANY



COLLECTIONS



LARGE SIZES



TECHNICAL SPECIFICATIONS



Porcelain Tile Decors Stone Look

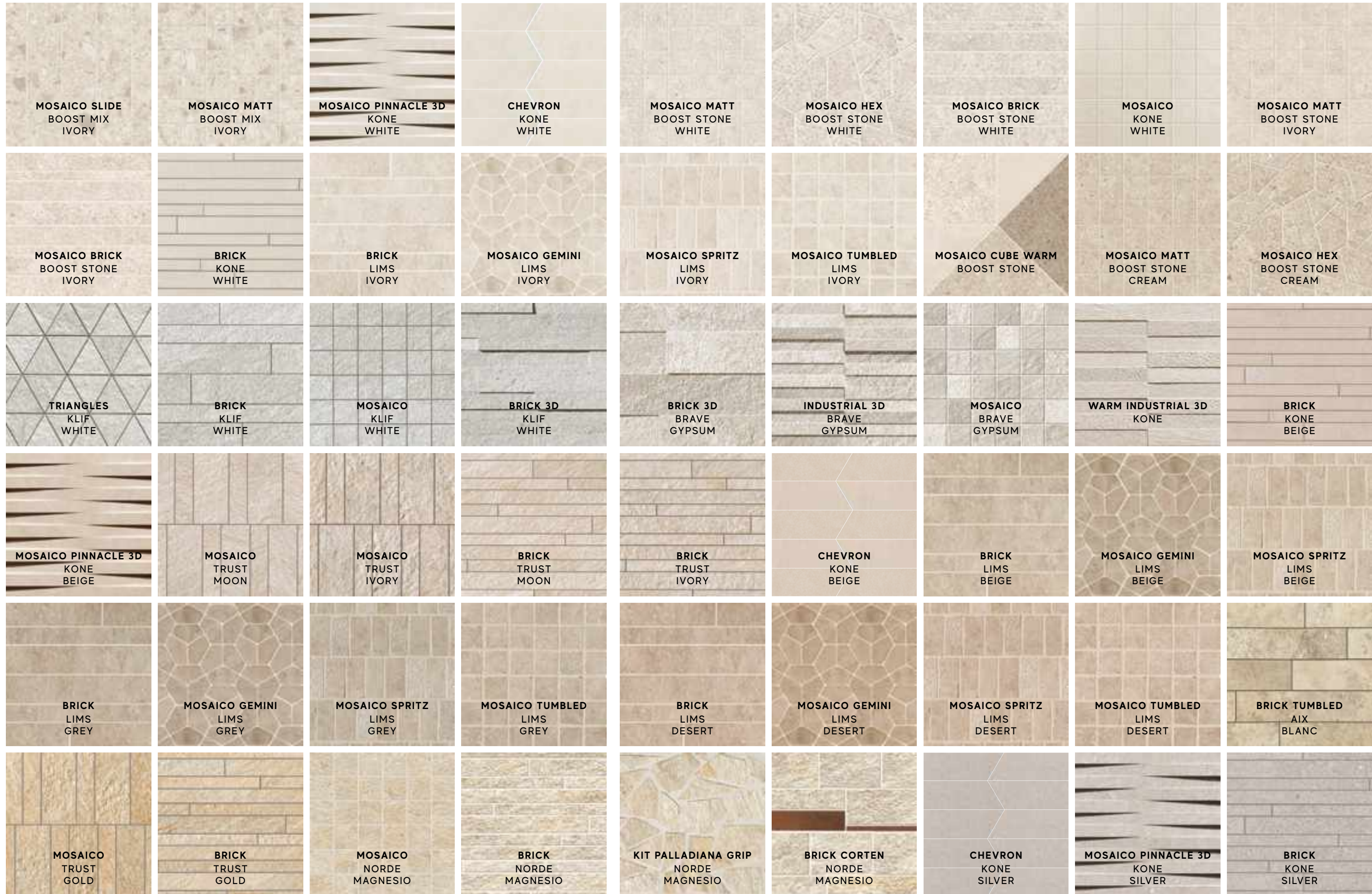

Porcelain Tile Decors Range — STONE LOOK

Porcelain Tile Decors Range — STONE LOOK

INDEX



PRODUCT FINDER



SURFACE RANGE



- PORCELAIN TILES
- OUTDOOR TILES
- WALL TILES
- PORCELAIN TILES DECORS
- WALL TILES DECORS

COMPANY



COLLECTIONS



LARGE SIZES



TECHNICAL SPECIFICATIONS



Porcelain Tile Decors  
Stone Look

Porcelain Tile Decors Range — STONE LOOK

Porcelain Tile Decors Range — STONE LOOK

INDEX



PRODUCT FINDER



SURFACE RANGE



- PORCELAIN TILES
- OUTDOOR TILES
- WALL TILES
- PORCELAIN TILES DECORS
- WALL TILES DECORS

COMPANY



COLLECTIONS



LARGE SIZES



TECHNICAL SPECIFICATIONS



Porcelain Tile Decors  
Stone Look

Porcelain Tile Decors Range — STONE LOOK

Porcelain Tile Decors Range — STONE LOOK

INDEX



PRODUCT FINDER



SURFACE RANGE



- PORCELAIN TILES
- OUTDOOR TILES
- WALL TILES
- PORCELAIN TILES DECORS
- WALL TILES DECORS

COMPANY



COLLECTIONS



LARGE SIZES



TECHNICAL SPECIFICATIONS





Porcelain Tile Decors Stone Look



Outdoor Tile Decors Stone Look

OUTDOOR  
± 20 mm



Porcelain Tile Decors Wood Look

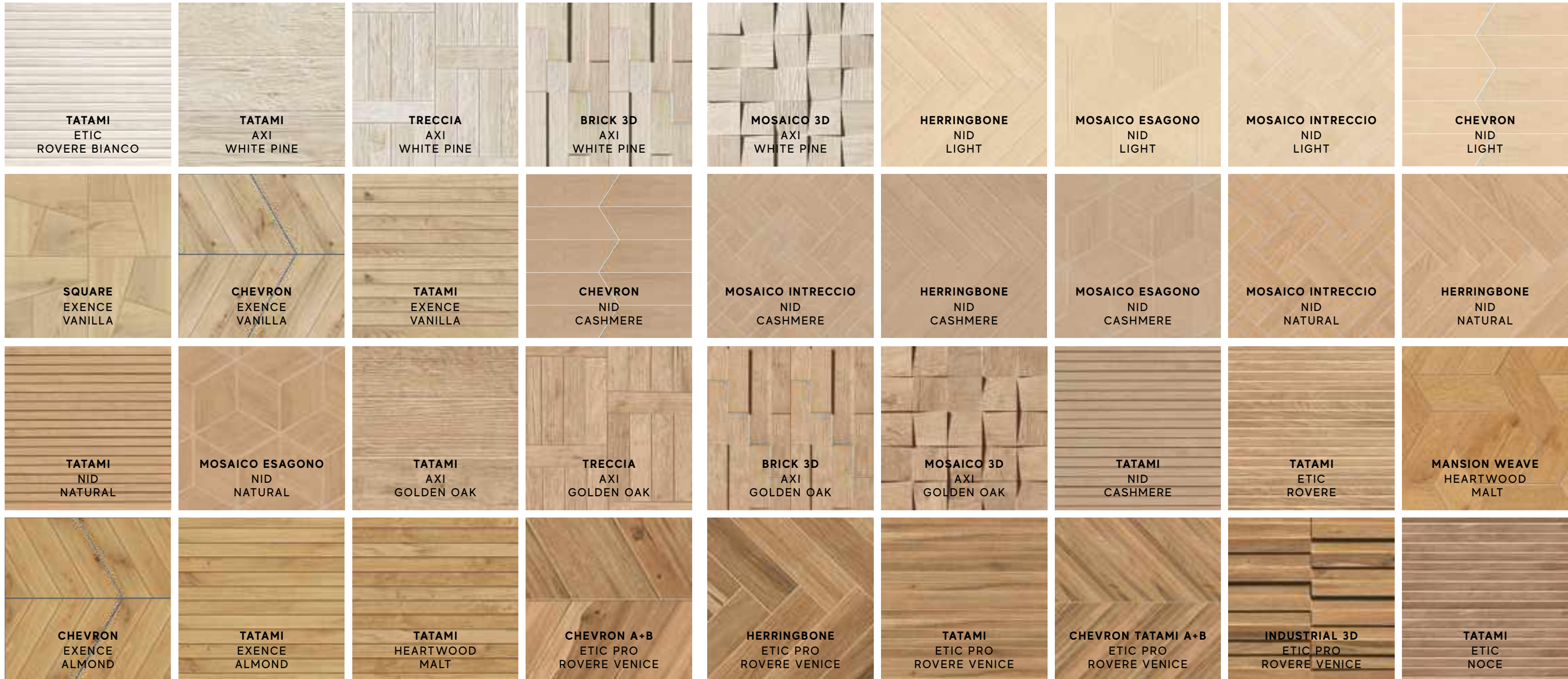

Porcelain Tile Decors Range, Outdoor Range — STONE, WOOD LOOK

Porcelain Tile Decors Range, Outdoor Range — STONE, WOOD LOOK

INDEX



PRODUCT FINDER



SURFACE RANGE



- PORCELAIN TILES
- OUTDOOR TILES
- WALL TILES
- PORCELAIN TILES DECORS
- WALL TILES DECORS

COMPANY



COLLECTIONS



LARGE SIZES



TECHNICAL SPECIFICATIONS



Porcelain Tile Decors  
Wood Look

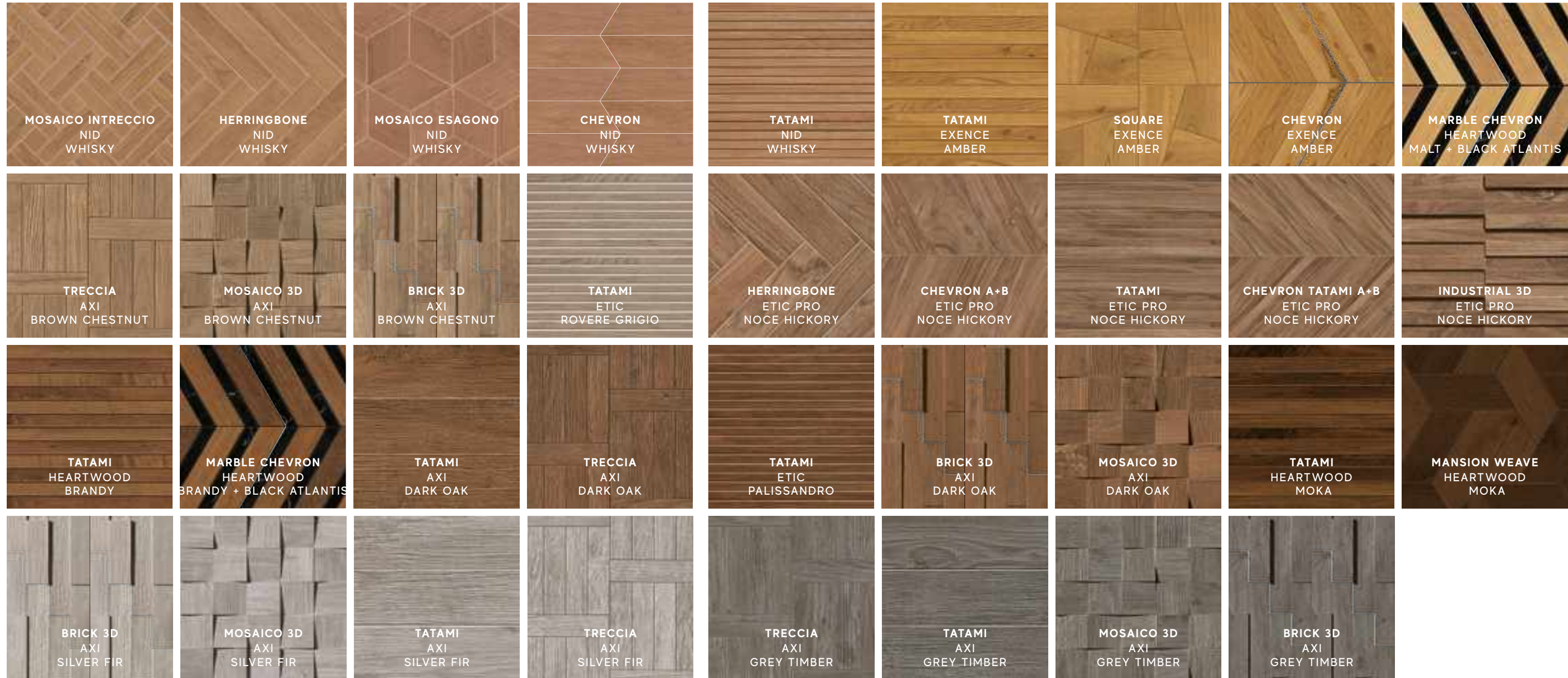

Porcelain Tile Decors Range — WOOD LOOK

Porcelain Tile Decors Range — WOOD LOOK

INDEX



PRODUCT  
FINDER



SURFACE  
RANGE



- PORCELAIN TILES
- OUTDOOR TILES
- WALL TILES
- PORCELAIN TILES DECORS
- WALL TILES DECORS

COMPANY



COLLECTIONS



LARGE SIZES



TECHNICAL  
SPECIFICATIONS



Wall Tile Decors  
Concrete &  
Resin Look



Wall Tile Decors Range — CONCRETE & RESIN LOOK

Wall Tile Decors Range — CONCRETE & RESIN LOOK

INDEX



PRODUCT  
FINDER



SURFACE  
RANGE



- PORCELAIN TILES
- OUTDOOR TILES
- WALL TILES
- PORCELAIN TILES DECORS
- WALL TILES DECORS

COMPANY



COLLECTIONS



LARGE SIZES



TECHNICAL  
SPECIFICATIONS



Wall Tile Decors  
Concrete &  
Resin Look



MOSAICO NEST  
BLAZE  
ALUMINIUM



TEXTURE  
BLAZE  
ALUMINIUM



MOSAICO Q  
BLAZE  
ALUMINIUM



MOSAICO DIAMOND  
MEK  
MEDIUM



MOSAICO CHEVRON  
MEK  
MEDIUM

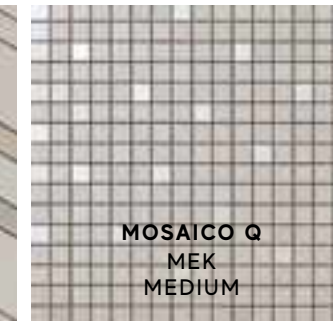

MOSAICO Q  
MEK  
MEDIUM



MINIBRICK  
BOOST  
PEARL



MINIBRICK  
BOOST  
GREY



ENIGMA  
PRISM



MOSAICO PIANO MATT  
BOOST NATURAL  
ECRU



MOSAICO  
PIANO MIX MATT  
BOOST NATURAL  
ECRU



MOSAICO  
TRACE MIX MATT  
BOOST NATURAL  
ECRU



MOSAIC Q  
PRISM  
SUEDE



MOSAICO BEAD  
PRISM  
SUEDE

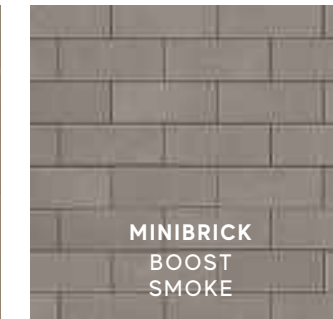

MINIBRICK  
BOOST  
SMOKE



MINIBRICK  
ARTY  
CHARCOAL

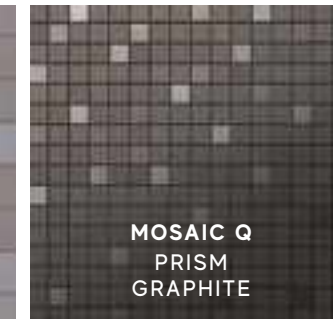

MOSAIC Q  
PRISM  
GRAPHITE

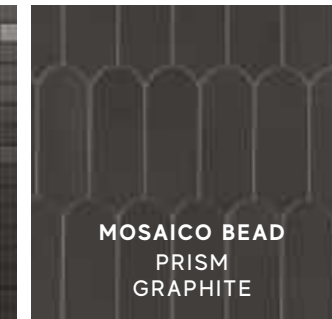

MOSAICO BEAD  
PRISM  
GRAPHITE

Wall Tile Decors  
Metal Look



MOSAICO NEST  
BLAZE  
CORTEN



MOSAICO Q  
BLAZE  
CORTEN



MOSAICO NEST  
BLAZE  
IRON



MOSAICO Q  
BLAZE  
IRON



STRIPES  
BLAZE  
IRON

Wall Tile Decors Range — CONCRETE & RESIN, METAL LOOK

Wall Tile Decors Range — CONCRETE & RESIN, METAL LOOK

INDEX



PRODUCT  
FINDER



SURFACE  
RANGE



- PORCELAIN TILES
- OUTDOOR TILES
- WALL TILES
- PORCELAIN TILES DECORS
- WALL TILES DECORS

COMPANY



COLLECTIONS



LARGE SIZES



TECHNICAL  
SPECIFICATIONS



Wall Tile Decors  
Marble Look



Wall Tile Decors Range — MARBLE LOOK

Wall Tile Decors Range — MARBLE LOOK

INDEX



PRODUCT  
FINDER



SURFACE  
RANGE



- PORCELAIN TILES
- OUTDOOR TILES
- WALL TILES
- PORCELAIN TILES DECORS
- WALL TILES DECORS

COMPANY



COLLECTIONS



LARGE SIZES



TECHNICAL  
SPECIFICATIONS



Wall Tile Decors  
Marble Look

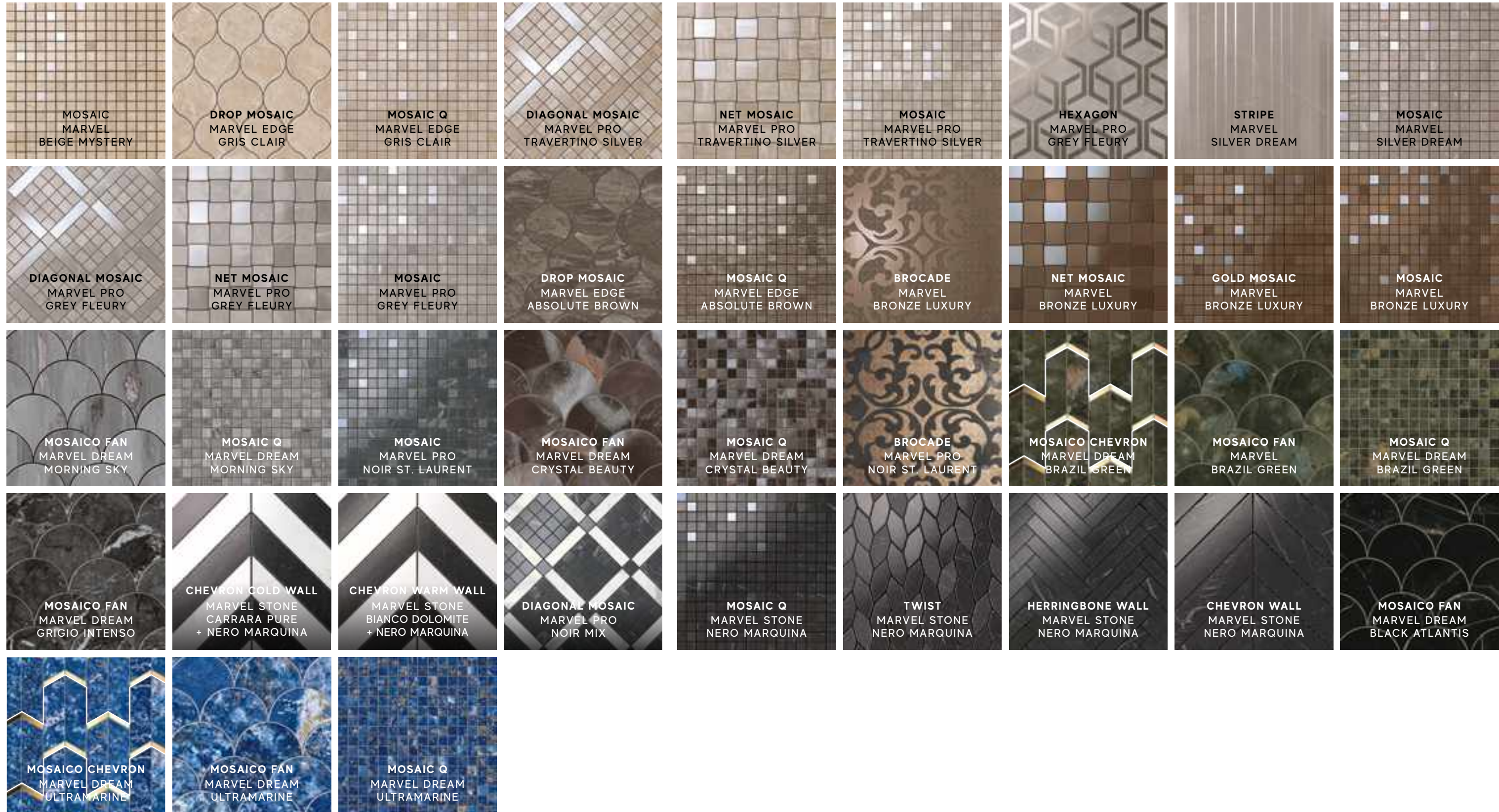

Wall Tile Decors Range — MARBLE LOOK

Wall Tile Decors Range — MARBLE LOOK

INDEX



PRODUCT FINDER



SURFACE RANGE



- PORCELAIN TILES
- OUTDOOR TILES
- WALL TILES
- PORCELAIN TILES DECORS
- WALL TILES DECORS

COMPANY



COLLECTIONS



LARGE SIZES



TECHNICAL SPECIFICATIONS



Wall Tile Decors Color Look

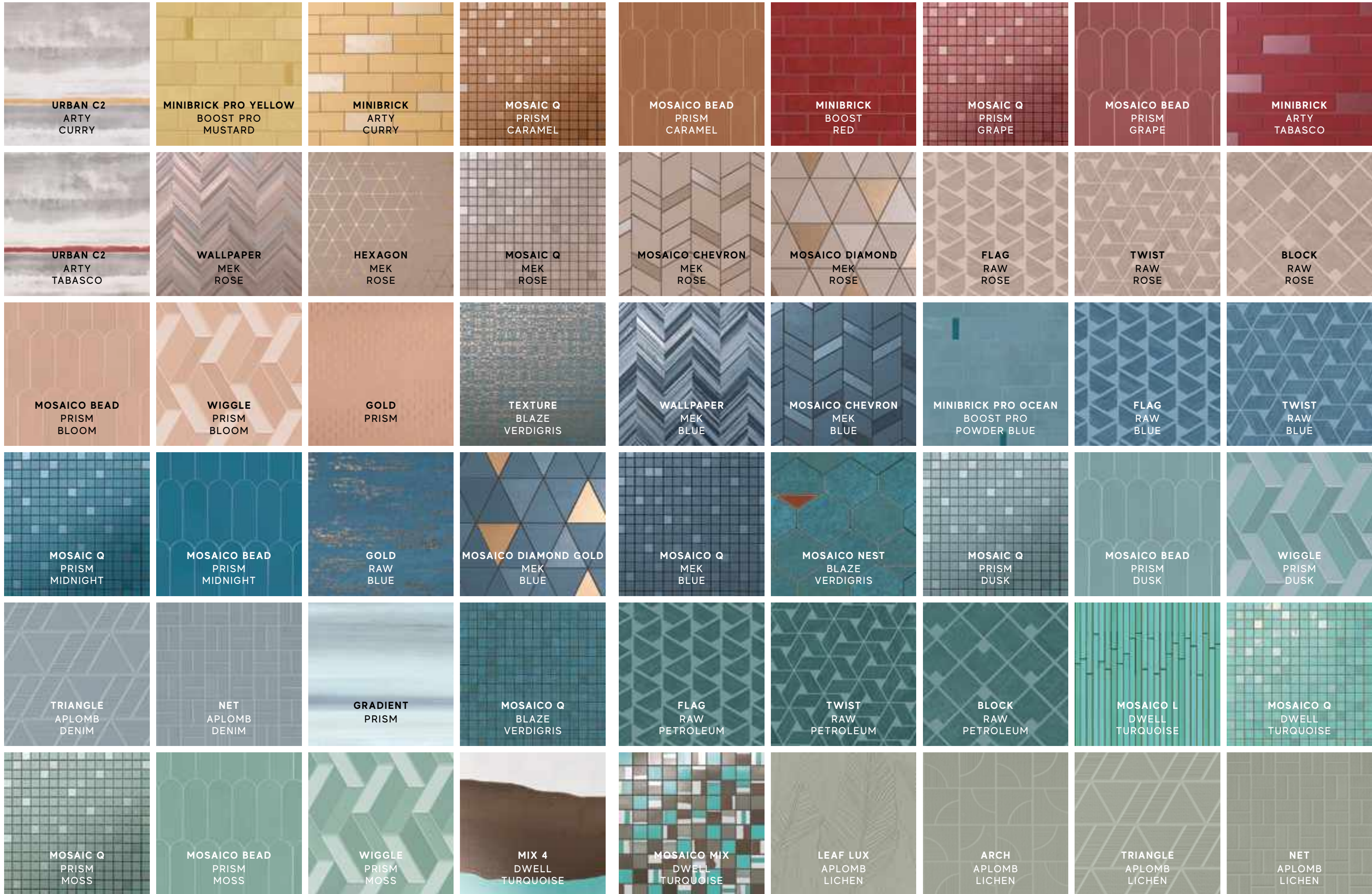

Wall Tile Decors Range — COLOR LOOK

Wall Tile Decors Range — COLOR LOOK

- INDEX
- PRODUCT FINDER
- SURFACE RANGE**
  - PORCELAIN TILES
  - OUTDOOR TILES
  - WALL TILES
  - PORCELAIN TILES DECORS
  - WALL TILES DECORS
- COMPANY
- COLLECTIONS
- LARGE SIZES
- TECHNICAL SPECIFICATIONS

Wall Tile Decors  
Color Look



MINIBRICK  
BOOST  
SAGE



BRUSH  
PRISM

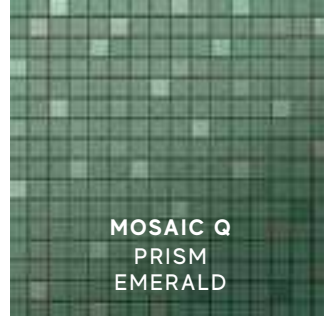

MOSAIC Q  
PRISM  
EMERALD

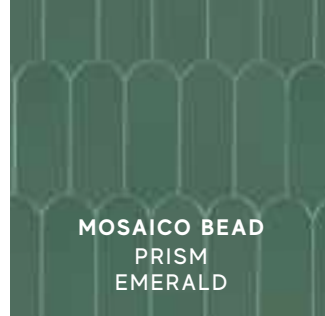

MOSAICO BEAD  
PRISM  
EMERALD



MOSAICO GOLD CIRCLES  
MEK



TEXTURE  
BLAZE  
CORTEN

Wall Tile Decors  
Stone Look



MOSAIC  
BRAVE  
GYPSUM



MINIBRICK TUMBLED  
AIX  
BLANC



MOSAIC  
BRAVE  
PEARL



MINIBRICK TUMBLED  
AIX  
CENDRE



MINIBRICK TUMBLED  
AIX  
BEIGE



MOSAIC  
BRAVE  
GREY

Wall Tile Decors Range — COLOR, STONE LOOK

Wall Tile Decors Range — COLOR, STONE LOOK

INDEX



PRODUCT  
FINDER



SURFACE  
RANGE



- PORCELAIN TILES
- OUTDOOR TILES
- WALL TILES
- PORCELAIN TILES DECORS
- WALL TILES DECORS

COMPANY



COLLECTIONS



LARGE SIZES



TECHNICAL  
SPECIFICATIONS









© Ceramiche Atlas Concorde

# Company

- 64 ABOUT US
- 94 RESPONSIBILITY
- 98 VALUES OF CERAMICS

INDEX 

PRODUCT FINDER 

SURFACE RANGE 

COMPANY 

COLLECTIONS 

LARGE SIZES 

TECHNICAL SPECIFICATIONS 



atlasconcorde.com >  
COMPANY PROFILE

# Our history

Over time Atlas Concorde has grown solidly on the pillars that its founders established at its inception: innovation, technology, research, ethics, respect for the environment, and confidence in the future.



© Ceramiche Atlas Concorde



© Ceramiche Atlas Concorde



© Ceramiche Atlas Concorde



© Ceramiche Atlas Concorde

Our history began in 1969 with the founding of Ceramiche Concorde, followed in 1974 by that of Ceramiche Atlas. The two companies merged in 1990 to create Atlas Concorde, a brand that has established itself as an international benchmark in the industry. Over time the company has grown solidly on the pillars that its founders established at its inception: innovation, technology, research, ethics, respect for the environment, and confidence in the future.

La nostra storia comincia nel 1969, con la fondazione di Ceramiche Concorde, cui è seguita nel 1974 quella di Ceramiche Atlas. Nel 1990 le due aziende si sono unite, dando vita ad Atlas Concorde, un marchio che si è affermato come punto di riferimento internazionale del settore. Nel corso del tempo, l'azienda è cresciuta solida sui pilastri che i fondatori hanno costruito fin dalle origini: innovazione, tecnologia, ricerca, etica, rispetto per l'ambiente e fiducia nel futuro.

Notre histoire commence en 1969, avec la création de Ceramiche Concorde, suivie par celle de Ceramiche Atlas en 1974. En 1990, les deux entreprises ont fusionnées en donnant naissance à Atlas Concorde, une marque qui s'est affirmée comme référence internationale du secteur. Avec le temps, l'entreprise s'est solidement développée sur les piliers que les fondateurs avaient construits dès leurs débuts: innovation, technologie, recherche, éthique, respect de l'environnement et confiance dans l'avenir.

Unsere Geschichte begann 1969 mit der Gründung von Ceramiche Concorde, auf die 1974 jene von Ceramiche Atlas folgte. 1990 wurden die beiden Unternehmen zusammengelegt, und mit Atlas Concorde entstand eine Marke, die am internationalen Markt bald zu einem maßgeblichen Namen der Branche werden sollte. Im Laufe der Zeit ist das Unternehmen kontinuierlich gewachsen, auch dank seiner bereits von den Gründern aufgebauten, soliden Grundpfeiler: Innovation, Technologie, Forschung, Ethik, Umweltbewusstsein und Vertrauen in die Zukunft.

Nuestra historia comienza en 1969, con la fundación de Ceramiche Concorde que fue seguida en 1974 por Ceramiche Atlas. En 1990, las dos empresas se fusionaron, creando Atlas Concorde una marca que se ha consolidado como referente internacional en el sector. Con el paso del tiempo, la empresa ha crecido sólidamente sobre los pilares que los fundadores construyeron desde sus orígenes: innovación, tecnología, investigación, ética, respeto por el medio ambiente y confianza en el futuro.

Наша история начинается в 1969 году, когда была основана компания Ceramiche Concorde. За этим в 1974 году последовало основание компании Ceramiche Atlas. В 1990 в результате их слияния появилась компания Atlas Concorde, которой суждено было стать одним из ориентиров в международной панораме керамического сектора. Со временем компания разрослась и укрепила свои позиции, оставаясь при этом верной своим исконным ценностям, таким как инновации, технологии, этика, уважение к окружающей среде, вера в будущее.



© Ceramiche Atlas Concorde

INDEX 

PRODUCT FINDER 

SURFACE RANGE 

COMPANY 

COLLECTIONS 

LARGE SIZES 

TECHNICAL SPECIFICATIONS 

# Designer surfaces

The company produces excellent ceramic materials for floors, walls, furnishings, worktops, and outdoor spaces, fully responding to the needs of modern international design.



© Ceramiche Atlas Concorde



© Ceramiche Atlas Concorde



© Ceramiche Atlas Concorde

Today Atlas Concorde is one of the leading global brands in the production of ceramic surfaces, with a strong vocation for design and architecture. Parent of the Concorde Group, the top Italian holding company in the industry, the company produces excellent ceramic materials for floors, walls, furnishings, worktops, and outdoor spaces, fully responding to the needs of modern international design.

Oggi Atlas Concorde è uno dei principali brand mondiali nella produzione di superfici ceramiche, con una spiccata vocazione al design e all'architettura. Capostipite del Gruppo Concorde, la prima holding italiana del settore, l'azienda produce materiali ceramici di eccellenza per pavimenti, rivestimenti, arredi, piani lavoro, ambienti outdoor, rispondendo in modo completo alle esigenze della moderna progettazione internazionale.

Aujourd'hui, Atlas Concorde est une des principales marques mondiales dans la production de carrelages en céramique, avec une forte vocation pour le design et l'architecture. Chef du Groupe Concorde, première holding italienne du secteur, l'entreprise produit des carreaux céramiques d'excellence pour les sols et les murs, ainsi que des équipements en céramique, des plans de travail et des matériaux pour l'extérieur, en répondant entièrement aux exigences de la conception moderne et internationale.

Heute ist Atlas Concorde einer der wichtigsten Hersteller von Keramikbelägen und zeichnet sich durch eine klare Berufung zum Design und zur Architektur aus. Das Stammhaus der Gruppo Concorde, der ersten italienischen Holding der Branche, produziert hochwertige Keramikmaterialien für Boden- und Wandbeläge, Einrichtungselemente, Arbeitsplatten und Außenbereiche, die den Ansprüchen der internationalen, modernen Bauplanung in jeder Hinsicht perfekt gerecht werden.

Hoy Atlas Concorde es una de las marcas líderes mundiales en la producción de superficies cerámicas, con una fuerte vocación por el diseño y la arquitectura. Empresa matriz del Gruppo Concorde el principal holding italiano del sector, la empresa produce excelentes materiales cerámicos para pavimentos, revestimientos, decoraciones, encimeras y ambientes exteriores, que satisfacen plenamente las necesidades del diseño moderno internacional.

Сегодня Atlas Concorde является одним из ведущих мировых производителей плитки, умеющим находить незаурядные решения для архитектуры и дизайна. Будучи родоначальницей группы Concorde, первого итальянского холдинга в отрасли, компания производит качественную плитку для оформления полов, стен, столешниц, наружных пространств, исчерпывающе отвечая требованиям современного проектирования.

# Multipurpose headquarters

The headquarters in Fiorano Modenese is a prestigious multipurpose site with large exhibition spaces and an elegant facility for hosting guests.



© Ceramiche Atlas Concorde



© Ceramiche Atlas Concorde



© Ceramiche Atlas Concorde



© Ceramiche Atlas Concorde

The headquarters in Fiorano Modenese is a prestigious multipurpose site equipped with large indoor and outdoor exhibition spaces as well as an elegant complex for hosting customers and visitors, complete with restaurant, sports, and recreational facilities situated in a beautiful centuries-old park.

Il quartier generale a Fiorano Modenese è una prestigiosa sede multifunzionale, dotata di ampie aree espositive interne ed esterne, oltre che di una elegante struttura per l'accoglienza di clienti e visitatori, attrezzata con ristorante, facilities sportive e ricreative all'interno di uno splendido parco secolare.

Il siège a Fiorano Modenese est un établissement prestigieux et multifonctionnel qui dispose de grandes zones d'exposition en intérieur et en extérieur, avec aussi un édifice élégant pour l'accueil des clients et des visiteurs, muni de restaurant et d'équipements sportifs et récréatifs, le tout au milieu d'un parc splendide de plantes centenaires.

Die elegante Unternehmenszentrale in Fiorano Modenese ist polyfunktional und elegant. Sie bietet einen stilvollen Rahmen für den Empfang von Kunden und Besuchern und umfasst ein Restaurant sowie Anlagen für Sport und Erholung in einem herrlichen, jahrhundertealten Park.

La sede de Fiorano Modenese es una prestigiosa sede multifuncional, dotada de amplias zonas de exposición interiores y exteriores, así como de una elegante estructura para la recepción de clientes y visitantes, dotada de un restaurante e instalaciones deportivas y recreativas en un hermoso parque.

Штаб-квартира в Фьорано-Моденезе является мультифункциональным местом с крытыми и открытыми выставочными площадками и комфортной инфраструктурой для приема клиентов и посетителей. Здесь же в старинном парке расположились ресторан, спортивные площадки и зоны для отдыха.



INDEX 

PRODUCT FINDER 

SURFACE RANGE 

COMPANY 

COLLECTIONS 

LARGE SIZES 

TECHNICAL SPECIFICATIONS 

# International presence

We have exclusive, functional, and constantly updated showrooms in the main centers of international design.



Showroom Franklin – TN, USA  
© Ceramiche Atlas Concorde



Showroom Moscow – Russia  
© Ceramiche Atlas Concorde



© Ceramiche Atlas Concorde Showroom Dubai – UAE



© Ceramiche Atlas Concorde Showroom Paris | Lyon – France



Atlas Concorde is an international company with plants in Italy and local production in the United States and Russia, as well as commercial branches on five continents. We have exclusive, functional, and constantly updated showrooms in Milan, Dubai, Paris, Moscow, London, and in other important international design centers.

Atlas Concorde è una azienda internazionale con stabilimenti produttivi in Italia, e produzioni dedicate in Stati Uniti e Russia, oltre che con filiali commerciali nei cinque continenti. Siamo presenti con showroom esclusive, funzionali e costantemente aggiornate a Milano, Dubai, Parigi, Mosca, Londra e in altri importanti centri della progettazione internazionale.

Atlas Concorde est une entreprise internationale avec des établissements de production en Italie, des productions dédiées aux États-Unis et en Russie, et des filiales commerciales sur les cinq continents. Nous sommes présents avec des showrooms exclusifs, fonctionnels et constamment mis à jour, à Milan, Dubai, Paris, Londres et Moscou, et dans d'autres villes importantes, leader dans la conception des projets architecturaux.

Atlas Concorde ist ein internationales Unternehmen mit Produktionsstätten in Italien und eigenen Werken in den Vereinigten Staaten und in Russland, sowie mit Vertriebsfilialen auf allen fünf Kontinenten. Mit unseren exklusiven, funktionellen und immer auf dem neuesten Stand gehaltenen Showrooms sind wir in Mailand, Dubai, Paris, Moskau, London und anderen bedeutenden Zentren der internationalen Bauplanung vertreten.

Atlas Concorde es una empresa multinacional con plantas de producción en Italia, y de producciones dedicadas en Estados Unidos y Rusia, así como sucursales de venta en los cinco continentes. Estamos presentes con salas de exposición exclusivas, funcionales y constantemente actualizadas en Milán, Dubai, París, Moscú, Londres y otros importantes centros de diseño internacionales.

Atlas Concorde – международная реалья. Располагает заводами в Италии, Соединенных Штатах и России, а также представительствами и филиалами на всех пяти континентах. Мы открыли функциональные шоу-румы в Милане, Дубае, Париже, Москве, Лондоне и других крупных мировых центрах архитектуры и дизайна.

# Global specialists

Private and public spaces, commercial properties, hospitality venues, indoor and outdoor areas: we offer the ideal solution for every need.



© Ceramiche Atlas Concorde



© Ceramiche Atlas Concorde



© Ceramiche Atlas Concorde



© Ceramiche Atlas Concorde

The variety of floor and wall tile collections we offer is what sets us apart. Atlas Concorde's products span a wide variety of styles and needs and are always able to offer the most suitable solution for each specific demand. Private and public spaces, commercial properties, hospitality venues, indoor and outdoor areas: we offer the ideal solution for every need.

La variété de l'offre des collections de carreaux de sols et de murs est notre signe distinctif. Les produits d'Atlas Concorde embrassent une grande pluralité de styles et d'exigences et sont en mesure de proposer toujours le produit qui répond le mieux à chaque demande spécifique. Lieux publics et privés, espaces commerciaux, hôtellerie, espaces intérieurs et extérieurs: nous avons la solution idéale pour chaque exigence.

La variedad de nuestras colecciones de pavimentos y revestimientos es lo que nos diferencia. Los productos de Atlas Concorde abarcan una amplia gama de estilos y requisitos y son capaces de ofrecer el producto más adecuado para cada solicitud específica. Espacios privados, públicos, comerciales, de hostelería, interiores y exteriores: tenemos la solución ideal para cada necesidad.

La varietà dell'offerta di collezioni per pavimenti e rivestimenti è ciò che ci contraddistingue. I prodotti di Atlas Concorde abbracciano una grande pluralità di stili ed esigenze e sono in grado di proporre sempre il prodotto più adatto per ogni richiesta specifica. Ambienti privati, pubblici, spazi commerciali, luoghi dell'ospitalità, aree interne ed esterne: per ogni esigenza disponiamo della soluzione ideale.

Wir sind für unser vielfältiges Angebot an Kollektionen für Wand- und Bodenbeläge berühmt. Die Produkte von Atlas Concorde decken viele Stile und Ansprüche ab, so dass für jeden Bedarf immer genau das Richtige dabei ist. Private und öffentliche Bereiche, Verkaufsräume und Gastgewerbe, Innen- und Außenbereiche: Wir bieten für jeden Bedarf die ideale Lösung.

Нас отличает широкий ассортимент коллекций плитки для полов и стен. Изделия Atlas Concorde охватывают огромное разнообразие стилей и способны удовлетворить любые запросы дизайнеров и архитекторов. Внутренние и наружные пространства частных домов, гостиниц, ресторанов, общественных и торговых объектов: у нас найдется идеальное решение для любого архитектурного контекста.



# Worlds of excellence

Atlas Concorde's "Worlds" consist of kindred product systems. They act as containers, sets of ceramic surfaces that are similar in style, look or areas of application.



© Ceramiche Atlas Concorde



© Ceramiche Atlas Concorde



© Ceramiche Atlas Concorde



© Ceramiche Atlas Concorde

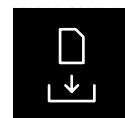

DOWNLOAD >  
BOOST WORLD CATALOG

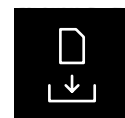

DOWNLOAD >  
OUTDOOR CATALOG

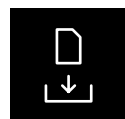

DOWNLOAD >  
MARVEL WORLD CATALOG

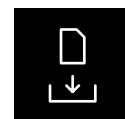

DOWNLOAD >  
LARGE SIZES CATALOG

Atlas Concorde's "Worlds" consist of kindred product systems. They act as containers, sets of ceramic surfaces that are similar in style, look or areas of application. Marvel World, Boost World, large formats, outdoor products, worktops, bathroom furnishings: Atlas Concorde's "Worlds" always present the most appropriate solution.

I "Mondi" di Atlas Concorde sono sistemi omogenei di prodotto. Si tratta di contenitori, insiemi di superfici ceramiche affini per stile, look o aree di applicazione. Marvel World, Boost World, grandi formati, prodotti per esterno, piani lavoro, arredo bagno: i "Mondi" Atlas Concorde sanno suggerire sempre la soluzione più opportuna.

Les "Worlds" d'Atlas Concorde sont des systèmes homogènes de produit. Il s'agit de "conteneurs", ensembles de carrelages céramiques liés par une même affinité de style, d'aspect ou domaines d'application. Marvel World, Boost World, grands formats, produits pour l'extérieur, plans de travail, équipements de salle de bains: les "Mondes" Atlas Concorde savent toujours conseiller la meilleure solution.

Die „Welten“ von Atlas Concorde sind homogene Produktsysteme. Es handelt sich um Produktgruppen aus hinsichtlich Stil, Look oder Anwendungsbereich affinen Keramikbeläge. Marvel World, Boost World, Große Formate, Outdoor-Produkte, Arbeitsplatten, Badmobiliar: in den Atlas Concorde-„Welten“ findet sich stets die beste Lösung.

Los «mundos» de Atlas Concorde son sistemas de productos homogéneos. Se trata de contenedores, conjuntos de superficies cerámicas similares en estilo, aspecto o áreas de aplicación. Marvel World, Boost World, grandes formatos, producto para exterior, superficies de trabajo, decoración baño: los «Mundos» Atlas Concorde siempre presentan la solución más oportuna.

«Миры» Atlas Concorde представляют собой однородные системы плитки. По сути это наборы плиток, сходных по стилю, внешнему виду или области применения. Marvel World, Boost World, большие форматы, изделия для наружного применения, столешницы, предметы для ванной: в «мирах» Atlas Concorde всегда найдется нужное решение для каждого проекта.

# A complete range

Atlas Concorde offers a complete range. Its floor and wall tiles are complemented by a wide selection of kitchen countertops and bathroom furnishing elements.



© Ceramiche Atlas Concorde



© Ceramiche Atlas Concorde



© Ceramiche Atlas Concorde



© Ceramiche Atlas Concorde

Our company partners with architects and interior designers to supply style, design solutions, and products featuring unrivaled technical superiority. With the Atlas Plan brand we offer worktops for kitchens, tables, and furniture, while with the Atlas Concorde Habitat project we provide solutions for bathroom furnishings. The Engineering and Contract Divisions assist designers with custom requests and special orders.

La nostra azienda è partner di progettisti e interior designer con stile, soluzioni di design e prodotti di assoluto rilievo tecnico. Con il brand Atlas Plan proponiamo piani lavoro per cucine, tavoli e arredo, mentre con il progetto Atlas Concorde Habitat offriamo soluzioni per il bagno. Le Divisioni Engineering e Contract assistono invece il progettista per richieste personalizzate e forniture speciali.

Notre entreprise est partenaire de concepteurs et de designers d'intérieur de grand style, avec des solutions de design et des produits de de qualité technique absolue. Sous la marque Atlas Plan, nous proposons des plans de travail pour la cuisine, des tables et autres éléments déco, tandis que le projet Atlas Concorde Habitat offre des solutions pour la salle de bains. En sus, les Divisions Engineering et Contract assistent le concepteur pour les demandes personnalisées et les fournitures spéciales.

Unser Unternehmen ist Partner von Planern und Innendesignern, denen es Stil, Designlösungen und technisch perfekte Produkte bereitstellt. Mit der Marke Atlas Plan bieten wir Arbeitsplatten für Küchen, Tische und andere Einrichtungselemente, während das Projekt Atlas Concorde Habitat Ideen für das Bad umfasst. Die Geschäftsbereiche Engineering und Contract unterstützen den Planer dagegen mit personalisierten Produkten und Sonderlieferungen.

Nuestra empresa colabora con planificadores y diseñadores de interiores proporcionando estilo, soluciones de diseño y productos técnicamente excelentes. Con la marca Atlas Plan ofrecemos encimeras para cocinas, mesas y decoraciones, mientras que con el proyecto Atlas Concorde Habitat ofrecemos soluciones para baños. Las Divisiones Engineering y Contract ayudan al diseñador con las solicitudes personalizadas y las entregas especiales.

Наша компания предлагает архитекторам и дизайнерам стильные и технически превосходные решения. Бренд Atlas Plan включает крупные плиты для оформления кухонных столешниц, столов, предметов обстановки, а проект Atlas Concorde Habitat – предметы для ваннх комнат. Подразделения Engineering и Contract помогают проектировщикам в разработке сложных индивидуальных проектов и в вопросах специальных поставок.



INDEX



PRODUCT  
FINDER



SURFACE  
RANGE



COMPANY



COLLECTIONS



LARGE SIZES



TECHNICAL  
SPECIFICATIONS



# Continuous innovation

For us, innovation means combining the legacy of an ancient “artisanal know-how” with maximum industrial efficiency, to respond to the most authentic concept of Made in Italy.



© Ceramiche Atlas Concorde



© Ceramiche Atlas Concorde



© Ceramiche Atlas Concorde



© Ceramiche Atlas Concorde

For us, innovation means investing in the most advanced technology, building a plant with sustainable energy consumption, having one of the most advanced logistics centers, and an internal Design Lab for developing new materials and surfaces. But it also means combining the legacy of an ancient “artisanal know-how” with maximum industrial efficiency, to respond to the most authentic concept of Made in Italy.

Innovare per noi significa investire nella più evoluta tecnologia, dotarsi di uno stabilimento sostenibile dal punto di vista energetico, disporre di un polo logistico tra i più avanzati e di un Design Lab interno per la ricerca di materiali e superfici sempre nuovi. Ma significa anche coniugare l’eredità di un antico “sapere fare artigianale” con la massima efficienza industriale, per rispondere al concetto più autentico di Made in Italy.

Pour nous, innover veut dire investir dans la technologie la plus évoluée, s’équiper d’un établissement durable du point de vue énergétique, disposer d’un des pôles logistiques les plus avancés et d’un Design Lab interne pour la recherche de matériaux et de nouvelles surfaces. Mais cela veut dire aussi conjuguer l’héritage ancien du “savoir-faire artisanal” avec la plus grande efficacité industrielle, pour répondre au concept le plus authentique du Made in Italy.

Innovation bedeutet für uns, in modernster Technologie zu investieren, und über ein energetisch nachhaltiges Werk, eines der modernsten Logistikzentren und ein internes Design Lab für immer wieder neue Material- und Oberflächenstudien zu verfügen. Aber Innovation bedeutet auch die Verbindung einer überlieferten Handwerkstradition mit maximaler industrieller Effizienz. Und verkörpert damit den wahren Kern des Made in Italy.

Para nosotros, la innovación significa invertir en la última tecnología, contar con una planta sostenible desde el punto de vista de energía, uno de los centros logísticos más avanzados y un Design Lab propio para la investigación de nuevos materiales y superficies. Pero también significa combinar la herencia del antiguo «saber hacer artesanal» con la máxima eficiencia industrial, para responder al concepto más auténtico del Made in Italy.

Для нас внедрять инновации означает инвестировать в новые технологии, вести энергетически устойчивое производство, располагать передовой логистической платформой и внутренним подразделением Design Lab, которое занимается изучением материалов и разработкой новых коллекций плитки. Но означает также сочетать древние традиции ремесленного мастерства с современными промышленными технологиями и создавать тем самым изделия, которые целиком воплощают стиль и качество «Made in Italy».



© Ceramiche Atlas Concorde

INDEX



PRODUCT  
FINDER



SURFACE  
RANGE



COMPANY



COLLECTIONS



LARGE SIZES



TECHNICAL  
SPECIFICATIONS



# On the side of design

We know how to interpret stimuli and suggestions to develop surfaces in line with the most advanced requirements of contemporary design.



Mario Ferrarini  
© Ceramiche Atlas Concorde



Matteo Brioni  
© Ceramiche Atlas Concorde



© Ceramiche Atlas Concorde Piero Lissoni



© Ceramiche Atlas Concorde

For years we have worked closely with internationally renowned Italian architects and designers. We collaborate with them and the many designers we meet all over the world to develop surfaces in line with the most advanced needs of contemporary design.

Collaboriamo da tempo con architetti e designer italiani di fama internazionale. Assieme a loro, e assieme ai tantissimi progettisti che incontriamo ovunque nel mondo, cogliamo stimoli e suggestioni per sviluppare superfici in linea con le più evolute esigenze del design contemporaneo.

Nous collaborons depuis longtemps avec des architectes et des designers italiens de renommée internationale. C'est avec eux et avec les nombreux concepteurs que nous rencontrons partout dans le monde, que nous saisissons les stimulations et suggestions pour développer des carreaux en accord avec les exigences les plus évoluées du design contemporain.

Seit längerem arbeiten wir mit international renommierten, italienischen Architekten und Designern zusammen. Mit ihnen und mit den zahlreichen Planern, denen wir überall in der Welt begegnen, greifen wir Anregungen und Ideen auf, um Beläge zu entwickeln, die den aktuellsten Trends des zeitgenössischen Designs entsprechen.

Llevamos mucho tiempo colaborando con arquitectos y diseñadores italianos de renombre internacional. Junto con ellos, y con los numerosos diseñadores que encontramos en todo el mundo, recogemos estímulos y sugerencias para desarrollar superficies acordes con las exigencias más avanzadas del diseño contemporáneo.

Мы уже давно сотрудничаем со всемирно известными итальянскими архитекторами и дизайнерами. Вместе с ними и со множеством других проектировщиков из разных стран мира, отталкиваясь от самых разнообразных стимулов, мы увлеченно работаем над разработкой новых плиток, способных удовлетворить даже самые сложные требования современного дизайна.



© Ceramiche Atlas Concorde

INDEX



PRODUCT  
FINDER



SURFACE  
RANGE



COMPANY



COLLECTIONS



LARGE SIZES



TECHNICAL  
SPECIFICATIONS



# Prestigious projects

We have a special relationship with the world of international design, as demonstrated by thousands of prestigious projects around the globe.



© Ceramiche Atlas Concorde



© Ceramiche Atlas Concorde



© Ceramiche Atlas Concorde



© Ceramiche Atlas Concorde



[atlasconcorde.com](https://atlasconcorde.com) >  
**PROJECTS**

We have a special relationship with the world of international design. Thousands of prestigious projects around the globe bear witness to this in a wide variety of architectural settings: residential, commercial, public, indoors, and outdoors.

Abbiamo un rapporto speciale con l'universo della progettazione internazionale. Migliaia di prestigiose realizzazioni nel mondo ne sono autentica testimonianza in tutti i contesti architettonici: residenziali, commerciali, pubblici, in spazi indoor o outdoor.

Nous avons des relations spéciales avec l'univers de la conception internationale. Des milliers de réalisations prestigieuses dans le monde entier et dans tous les secteurs architecturaux en sont le meilleur témoignage: résidentiels, commerciaux, publics et espaces d'intérieur et d'extérieur.

Wir haben eine besondere Beziehung zum internationalen Panorama der Bauplanung. Tausende realisierter Projekte bezeugen dies in allen Bereichen der Branche: Wohnungs- und Gewerbebau, öffentliche Bauten, Innen- und Außenbereiche.

Tenemos una relación especial con el universo del diseño internacional. Miles de proyectos prestigiosos en todo el mundo lo atestiguan en todos los contextos arquitectónicos: residenciales, comerciales, públicos, de interiores y de exteriores.

У нас особые отношения с миром международного дизайна. Об этом свидетельствуют тысячи реализованных по всему миру проектов: жилых, коммерческих, общественных, причем как интерьерных, так и уличных.



# Social responsibility

Social responsibility is an integral part of Atlas Concorde's business model.



© Ceramiche Atlas Concorde



© Ceramiche Atlas Concorde



© Ceramiche Atlas Concorde



© Ceramiche Atlas Concorde



atlasconcorde.com >  
**RESPONSIBILITY**

Social responsibility is an integral part of Atlas Concorde's business model. This is evident at all levels of the company, in its training and professional growth programs, investments in workplace safety, and the wellbeing of its employees. Some examples include the Concorde Nursery, an excellent facility that is also open to the area residents, and numerous initiatives in support of local communities.

La responsabilità sociale è parte integrante del modello imprenditoriale di Atlas Concorde. A tutti i livelli aziendali, programmi di formazione e crescita professionale, investimenti per la sicurezza sul lavoro e il benessere dei dipendenti ne sono la testimonianza. Tra questi spiccano inoltre l'Asilo Concorde, una struttura di eccellenza aperta anche al territorio, e numerose iniziative a sostegno delle Comunità locali.

La responsabilité sociale fait partie intégrante de la culture d'entreprise d'Atlas Concorde. À tous les niveaux de l'entreprise, des programmes de formation et de développement professionnel, les investissements pour la sécurité sur le travail et le bien-être du personnel en sont le témoignage. Parmi ces initiatives, également la crèche Concorde, une structure d'excellence ouverte à tout territoire, et de nombreuses autres initiatives en soutien des communautés locales.

Soziale Verantwortung ist ein wichtiger Bestandteil des unternehmerischen Modells von Atlas Concorde. So werden auf allen Ebenen des Unternehmens Fortbildungs- und Schulungsprogramme angeboten, und überall wird in die Sicherheit am Arbeitsplatz und in das Wohlbefinden der Mitarbeiter investiert. Dazu gehören außerdem der auch der Bevölkerung offenstehende und außerordentlich geschätzte Concorde-Kindergarten sowie zahlreiche Initiativen zur Unterstützung der örtlichen Gemeinschaften.

La responsabilidad social es parte integral del modelo de negocio de Atlas Concorde. En todos los niveles de la empresa, los programas de formación y desarrollo profesional, las inversiones en seguridad laboral y bienestar de los empleados lo demuestran. Entre ellos también se encuentra Asilo Concorde, una guardería infantil de excelencia, también abierto al territorio, así como numerosas iniciativas de apoyo a las comunidades locales.

Социальная ответственность является неотъемлемой составляющей бизнес-модели Atlas Concorde. Доказательством этого служат программы повышения квалификации и постоянные вложения средств в обеспечение безопасных и благоприятных условий труда. Для детей работников компании и других жителей города работает детский сад Asilo Concorde. Кроме того, компания предпринимает множество инициатив в поддержку населения своего города и региона.

# Environmental sustainability

Our certifications:



## Energy efficiency

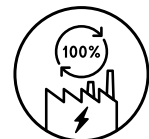

100% autonomous on energy



Hot air heat recovery from kilns and cooling water



40% savings on natural gas

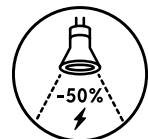

100% LED lighting  
50% ANNUAL SAVINGS in electricity consumption

## Waste management



100% recycled scraps



99% of waste sent for recovery and 25% waste reduction in the last two years

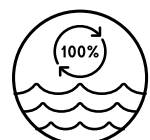

100% recycled industrial water and 27% reduction in water consumption in the last two years

## Environment and health first



Cardboard and other packaging: 100% recycled material

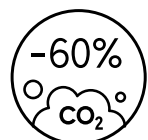

MAV Automatic Vertical Warehouse: 60% CO2 reduction



Complete air filtration

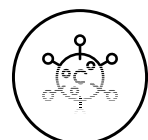

Absence of carcinogenic substances in products

An ecological transition is among the company's industrial priorities. Our plants comply with the most stringent international regulations – fully automated and low-impact – as they are equipped with energy cogeneration systems. A constant commitment to the total reduction of waste and emissions completes the picture of a company oriented towards maximum environmental sustainability.

La transizione ecologica è tra le priorità industriali dell'azienda. I nostri impianti sono conformi alle più stringenti normative internazionali, completamente automatizzati e a basso impatto, in quanto dotati di sistemi di cogenerazione energetica. Il costante impegno per la totale riduzione degli sprechi e delle emissioni completano il quadro di un'azienda orientata alla massima sostenibilità ambientale.

La transition écologique est une des priorités industrielles de l'entreprise. Nos installations sont conformes aux réglementations internationales les plus sévères, entièrement automatisées et à faible impact, car équipées de systèmes de cogénération énergétique. L'engagement constant pour la réduction totale du gaspillage et des émissions complète le tableau d'une entreprise engagée pour une meilleure durabilité environnementale.

Der ökologische Wandel gehört zu den Prioritäten der industriellen Strategie des Unternehmens. Unsere Anlagen entsprechen den strengsten internationalen Richtlinien; sie arbeiten vollautomatisch und umweltschonend, denn sie sind mit Kraft-Wärme-Kopplungssystemen ausgerüstet. Ein weiterer Aspekt dieses Unternehmens, das sich ganz der Erreichung maximaler ökologischer Nachhaltigkeit verschrieben hat, ist sein kontinuierliches Engagement für die völlige Eliminierung von Verschwendung und Emissionen.

La transición ecológica está entre las prioridades industriales de la empresa. Nuestras plantas cumplen las normas internacionales más estrictas, totalmente automatizadas y de bajo impacto, ya que están equipadas con sistemas de cogeneración energética. Los esfuerzos constantes por reducir completamente los residuos y las emisiones completan la imagen de una empresa centrada en la máxima sostenibilidad medioambiental.

Экологический переход – один из основных технологических приоритетов компании. Наши производственные процессы отвечают требованиям строжайших международных стандартов, автоматизированы, оказывают минимальное воздействие на окружающую среду, а кроме того, на заводе работает собственная когенерационная установка. А еще мы принимаем меры по сокращению отходов и выбросов, что является еще одним свидетельством ориентации на экологическую устойчивость.

# Porcelain tiles: an eco-friendly material



## Energy efficient

The thermal inertia of porcelain tiles reduces heating and cooling peaks in every season and climate, moderating room temperature changes with consequent energy savings.

## Ecological

Porcelain tiles have a low environmental impact at all stages of their life cycle, from the extraction of raw materials in select quarries to industrial manufacturing carried out using efficient energy and water systems, and finally to their disposal, being fully recyclable.

## Recycling and re-use

Porcelain tiles are one of the most environmentally friendly options available for covering surfaces, including floors and walls. Produced mostly with recycled and recyclable materials, they have an almost unlimited durability and consistent technical and esthetic performance over time.

## Ideal for floor heating systems

Porcelain tiles efficiently retain heat, emitting it gradually and uniformly. This makes them the ideal choice for underfloor heating systems, also thanks to their generally lower thickness compared to other materials, which may therefore not be as efficient.

# Porcelain and wall tiles: a safe choice



ENG



ITA



FRA



SPA



DEU



RUS

## Health



Prevent  
bacterial growth

© Ceramiche Atlas Concorde



Zero  
PVC

© Ceramiche Atlas Concorde

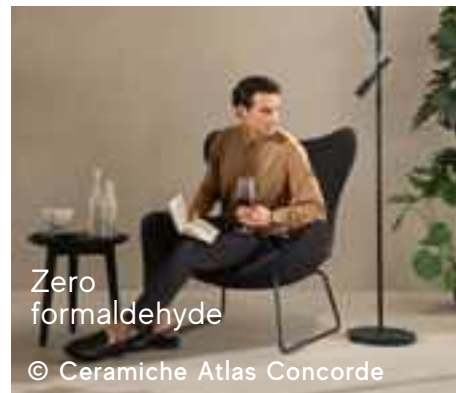

Zero  
formaldehyde

© Ceramiche Atlas Concorde



Zero  
allergens

© Ceramiche Atlas Concorde



Zero  
VOCs

© Ceramiche Atlas Concorde

## Safety

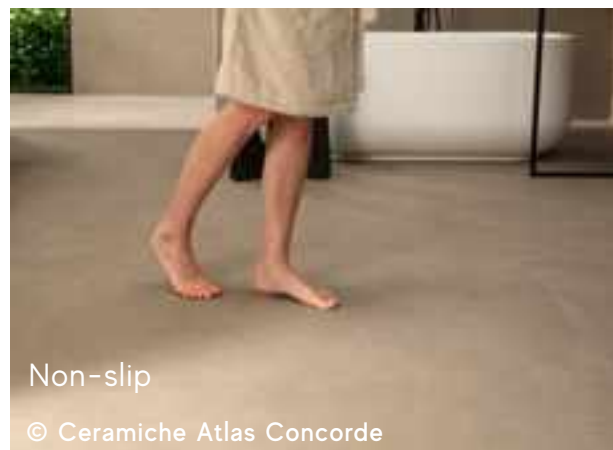

Non-slip

© Ceramiche Atlas Concorde



Fire  
resistant

© Ceramiche Atlas Concorde



Heat  
resistant

© Ceramiche Atlas Concorde

## Resistance and duration



Easy to maintain

© Ceramiche Atlas Concorde



UV  
Resistant

© Ceramiche Atlas Concorde



Stain  
resistant

© Ceramiche Atlas Concorde



Resistant  
to acids

© Ceramiche Atlas Concorde



Resistant to  
chemicals

© Ceramiche Atlas Concorde



Resistant to  
thermal shock

© Ceramiche Atlas Concorde



Easy  
to clean

© Ceramiche Atlas Concorde



Waterproof

© Ceramiche Atlas Concorde



Scratch  
resistant

© Ceramiche Atlas Concorde



Frost  
resistant

© Ceramiche Atlas Concorde

## Wall tile benefits



Ease of  
installation

© Ceramiche Atlas Concorde



Extremely  
easy to clean

© Ceramiche Atlas Concorde

# Ethical identity

For Atlas Concorde, being Made in Italy is not just a prestigious certification of style, design, and production excellence, but an identity that involves all aspects of its business.



© Ceramiche Atlas Concorde



© Ceramiche Atlas Concorde



© Ceramiche Atlas Concorde



© Ceramiche Atlas Concorde

For Atlas Concorde, being Made in Italy is not just a prestigious certification of style, design, and production excellence, but an identity that involves all aspects of its business. For this reason, we identify with the values expressed by Confindustria Ceramica's ethical code, which guarantee absolute compliance with labor regulations, and with the marks Made in Italy and Ceramics of Italy, which certify the quality of authentic Italian style.

Per Atlas Concorde, Made in Italy non è solo un prestigioso attestato di stile, design ed eccellenza produttiva, ma un modo di essere che coinvolge tutti gli aspetti della propria attività. Per questo ci riconosciamo nei valori espressi dal codice etico di Confindustria Ceramica, che garantiscono il rispetto assoluto delle normative sul lavoro, e nei marchi Made in Italy e Ceramics of Italy, che certificano la qualità dell'autentico stile italiano.

Pour Atlas Concorde, le Made in Italy n'est pas seulement une prestigieuse attestation de style, de design et d'excellence de la production, mais une manière d'être qui prend en compte tous les aspects de notre activité. C'est pourquoi nous nous reconnaissons d'abord dans les valeurs exprimées dans le code éthique de Confindustria Ceramica qui garantissent le respect absolu des réglementations sur le travail, mais aussi dans les labels Made in Italy et Ceramics of Italy qui certifient la qualité du vrai style italien.

Für Atlas Concorde ist das Made in Italy mehr als nur ein prestigievolles Gütezeichen für Stil, Design und exzellente Produktion. Es ist eine Einstellung, die alle Aspekte der Tätigkeit einbezieht. Wir teilen die im Ethikcode des Unternehmensverbands Confindustria Ceramica zum Ausdruck kommenden Werte, welche die strenge Einhaltung der arbeitsrechtlichen Vorschriften garantieren, sowie jene der Gütesiegel Made in Italy und Ceramics of Italy als Garantie von Qualität in authentischem, italienischem Stil.

Para Atlas Concorde, Made in Italy no es sólo un prestigioso certificado de excelencia en estilo, diseño y fabricación, sino una forma de ser que abarca todos los aspectos de su actividad. Por eso nos identificamos con los valores expresados en el código ético de Confindustria Ceramica, que garantizan el respeto absoluto de la normativa laboral, y de las marcas Made in Italy y Ceramics of Italy, que certifican la calidad del auténtico estilo italiano.

«Made in Italy» для Atlas Concorde не просто знак подтверждения стиля и качественного производства, а образ жизни, который включает в себя все аспекты деятельности. Поэтому мы полностью разделяем ценности, закрепленные в «Этическом кодексе» федерации Confindustria Ceramica (ассоциация предприятий керамической отрасли) и предусматривающие строгое соблюдение трудового законодательства. А маркировка Made in Italy и Ceramics of Italy на нашей плитке является гарантией ее качества и аутентичного итальянского дизайна.



MADE IN ITALY





© Ceramiche Atlas Concorde

# Collections

- 3D Wall**
  - > 3D WALL CARVE
  - > 3D WALL DESIGN
  
- Concrete & Resin Look**
  - > BOOST
  - > BOOST NATURAL
  - > BOOST PRO
  - > CANONE INVERSO
  - > DWELL
  - > MARK
  - > MEK
  - > PRISM
  - > RAW
  - > VENTI BOOST
  
  - > APLOMB
  - > ARTY
  
- Metal Look**
  - > BLAZE
  
- Marble Look**
  - > MARVEL
  - > MARVEL DREAM
  - > MARVEL EDGE
  - > MARVEL GEMS
  - > MARVEL PRO
  - > MARVEL SHINE
  - > MARVEL STONE
  
- Stone Look**
  - > AIX
  - > BOOST MIX
  - > BOOST STONE
  - > BRAVE
  - > DOLMEN PRO
  - > KLIF
  - > KONE
  - > LIMS
  - > MARVEL STONE
  - > NORDE
  - > TRUST
  
- Wood Look**
  - > AXI
  - > ETIC
  - > ETIC PRO
  - > EXENCE
  - > HEARTWOOD
  - > NID
  
  - > GROUNDTRACK

INDEX 

PRODUCT FINDER 

SURFACE RANGE 

COMPANY 

COLLECTIONS 

- 3D WALL
- CONCRETE & RESIN LOOK
- METAL LOOK
- MARBLE LOOK
- STONE LOOK
- WOOD LOOK

LARGE SIZES 

TECHNICAL SPECIFICATIONS 

# 3D Wall Carve

DOWNLOAD >  
CATALOG &  
IMAGE GALLERY

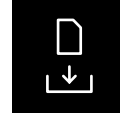

ENJOY THE  
VIDEO

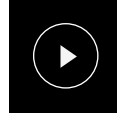

3D SIGN + 3D SQUARES: CAPSULE COLLECTION by Piero Lissoni



© Ceramiche Atlas Concorde

© Copyright 2022 by Ceramiche Atlas Concorde S.p.a.



© Ceramiche Atlas Concorde

© Copyright 2022 by Ceramiche Atlas Concorde S.p.a.



© Ceramiche Atlas Concorde

© Copyright 2022 by Ceramiche Atlas Concorde S.p.a.

## Wall Tiles



### WHITEBODY WALL TILES - RECTIFIED MONOCALIBER

Sizes	Thickness	Surface finish
40x80 cm - 15 <sup>3</sup> / <sub>4</sub> "x31 <sup>1</sup> / <sub>2</sub> "	± 8,5 mm	Matte
<b>3D WALL TILES</b> 40x80 cm - 15 <sup>3</sup> / <sub>4</sub> "x31 <sup>1</sup> / <sub>2</sub> "	± 8,5 mm	Matte

INDEX



PRODUCT  
FINDER



SURFACE  
RANGE



COMPANY



COLLECTIONS



3D WALL

- CONCRETE & RESIN LOOK
- METAL LOOK
- MARBLE LOOK
- STONE LOOK
- WOOD LOOK

LARGE SIZES



TECHNICAL  
SPECIFICATIONS



Whitebody wall tiles - Rivestimenti in pasta bianca - Revêtements en pâte blanche - Weißscherbige Wandfliesen - Revestimientos en pasta blanca - Настенная плитка из белой глины  
Rectified monocaliber - Rettificato monocalibro - Rectifié mono-calibre - Geschliffen einkalbrig - Rectificado monocalibre - Ретифицированный в одном калибре

# 3D Wall Carve

## MATTE SURFACE



V1 Uniform Appearance



± 8,5 mm

40x80 cm - 15<sup>3</sup>/<sub>4</sub>"x31<sup>1</sup>/<sub>2</sub>"

A57T 3D Wall Carve Field White

A57U 3D Wall Carve Field Pearl

A57V 3D Wall Carve Field Ivory



± 8,5 mm 3D WALL

40x80 cm - 15<sup>3</sup>/<sub>4</sub>"x31<sup>1</sup>/<sub>2</sub>"

A57W 3D Wall Carve Sign White

A57X 3D Wall Carve Sign Pearl

A57Y 3D Wall Carve Sign Ivory

A57Z 3D Wall Carve Squares White

A57Ø 3D Wall Carve Squares Pearl

A571 3D Wall Carve Squares Ivory

A572 3D Wall Carve Chisel White

A573 3D Wall Carve Chisel Pearl

A574 3D Wall Carve Chisel Ivory

A575 3D Wall Carve Whittle White

A576 3D Wall Carve Whittle Pearl

A577 3D Wall Carve Whittle Ivory

A578 3D Wall Carve Leaf White

A58A 3D Wall Carve Leaf Pearl

A579 3D Wall Carve Leaf Ivory

## TRIM TILES

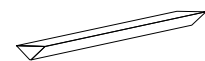

1,4x40 cm - <sup>5</sup>/<sub>8</sub>"x15<sup>3</sup>/<sub>4</sub>"

A60A 3D Wall Carve Field White Corner 40 \*

A60B 3D Wall Carve Field Pearl Corner 40 \*

A60C 3D Wall Carve Field Ivory Corner 40 \*



1,4x1,4 cm - <sup>5</sup>/<sub>8</sub>"x<sup>5</sup>/<sub>8</sub>"

A60D 3D Wall Carve Field White Corner A.E. \*

A60E 3D Wall Carve Field Pearl Corner A.E. \*

A60F 3D Wall Carve Field Ivory Corner A.E. \*

\* These parts are supplied to order - I pezzi sono disponibili su ordinazione - Les pièces sont disponibles sur commande - Die Teile sind auf Bestellung lieferbar - Las piezas se hacen por encargo - Изготавливаются на заказ  
Matte surface - Superficie matt - Surface Mat - Matte Oberfläche - Superficie Mate - Матовая поверхность



INDEX



PRODUCT  
FINDER



SURFACE  
RANGE



COMPANY



COLLECTIONS



3D WALL

CONCRETE & RESIN LOOK

METAL LOOK

MARBLE LOOK

STONE LOOK

WOOD LOOK

LARGE SIZES



TECHNICAL  
SPECIFICATIONS





# 3D Wall Design

DOWNLOAD >  
CATALOG &  
IMAGE GALLERY

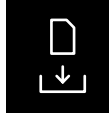

© Ceramiche Atlas Concorde



© Ceramiche Atlas Concorde



© Ceramiche Atlas Concorde

## Wall Tiles



### SINUOUS DESIGN



### MULTI-FACETED DESIGN

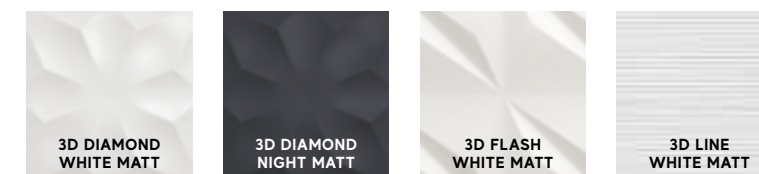

### GEOMETRIC DESIGN



### SOLID DESIGN

### WHITEBODY WALL TILES - RECTIFIED MONOCALIBER

Sizes	Thickness	Surface finish
50x120 cm - 19 5/8"x47 1/4"	± 11 mm	Matte, Shiny
	± 8,5 mm	Matte Shiny
40x80 cm - 15 3/4"x31 1/2"	± 10 mm	Matte, Shiny
	± 8,5 mm	Matte, Shiny
30,5x56 cm - 12"x22"	± 9,5 mm	Matte
	± 8,5 mm	Matte

Whitebody wall tiles - Rivestimenti in pasta bianca - Revêtements en pâte blanche - Weißscherbige Wandfliesen - Revestimientos en pasta blanca - Настенная плитка из белой глины  
Rectified monocaliber - Rettificato monocalibro - Rectifié mono-calibre - Geschliffen einkalibrig - Rectificado monocalibre - Ретифицированный в одном калибре

INDEX



PRODUCT  
FINDER



SURFACE  
RANGE



COMPANY



COLLECTIONS



- 3D WALL
- CONCRETE & RESIN LOOK
- METAL LOOK
- MARBLE LOOK
- STONE LOOK
- WOOD LOOK

LARGE SIZES



TECHNICAL  
SPECIFICATIONS



# 3D Wall Design

## Wall Tiles

### MATTE SURFACE



± 11 mm

50x120 cm - 19<sup>5</sup>/<sub>8</sub>"x47<sup>1</sup>/<sub>4</sub>"

A6BJ 3D Wall Design 3D Ultra Blade White Matt \*

A6BH 3D Wall Design 3D Line White Matt \*

A6BI 3D Wall Design 3D Flows White Matt \*



± 8,5 mm

50x120 cm - 19<sup>5</sup>/<sub>8</sub>"x47<sup>1</sup>/<sub>4</sub>"

A6BF 3D Wall Design Solid White Matt



± 10 mm

40x80 cm - 15<sup>3</sup>/<sub>4</sub>"x31<sup>1</sup>/<sub>2</sub>"

8DMA 3D Wall Design 3D Angle White Matt \*

8DBW 3D Wall Design 3D Blade White Matt \*

8DAW 3D Wall Design 3D Stars White Matt \*

8DDI 3D Wall Design 3D Diamond White Matt \*

8DDN 3D Wall Design 3D Diamond Night Matt \*

8DFW 3D Wall Design 3D Flash White Matt \*

8DUW 3D Wall Design 3D Dune White Matt \*

8DUS 3D Wall Design 3D Dune Sand Matt \*

8DMW 3D Wall Design 3D Wind White Matt \*

8AWS 3D Wall Design 3D Wave Arty Sugar Matt \*

8AWM 3D Wall Design 3D Wave Arty Milk Matt \*

8SBW 3D Wall Design 3D Ribbon White Matt \*

A6PA 3D Wall Design 3D Blade Rose Matt \*



± 8,5 mm

40x80 cm - 15<sup>3</sup>/<sub>4</sub>"x31<sup>1</sup>/<sub>2</sub>"

8DSO 3D Wall Design Solid White Matt

8DSA 3D Wall Design Solid Sand Matt



± 9,5 mm

30,5x56 cm - 12"x22"

9D5B 3D Wall Design 3D Ultra Blade White Matt \*

9D5W 3D Wall Design 3D Wave White Matt \*



± 8,5 mm

30,5x56 cm - 12"x22"

9D5S 3D Wall Design Solid White Matt

### SHINY SURFACE



± 8,5 mm

50x120 cm - 19<sup>5</sup>/<sub>8</sub>"x47<sup>1</sup>/<sub>4</sub>"

A6BG 3D Wall Design Solid White Glossy



± 10 mm

40x80 cm - 15<sup>3</sup>/<sub>4</sub>"x31<sup>1</sup>/<sub>2</sub>"

8DWG 3D Wall Design 3D Wave White Glossy \*



± 8,5 mm

40x80 cm - 15<sup>3</sup>/<sub>4</sub>"x31<sup>1</sup>/<sub>2</sub>"

8DSL 3D Wall Design Solid White Glossy

### TRIM TILES

LD8W Spigolo 8,5mm White Matt  
0,8x20 cm - 3<sup>1</sup>/<sub>8</sub>"x7<sup>7</sup>/<sub>8</sub>"

A8DW Spigolo 8,5mm White Matt A.E.  
0,8x0,8 cm - 3<sup>1</sup>/<sub>8</sub>"x3<sup>1</sup>/<sub>8</sub>"

LDWM Spigolo 10mm White Matt \* ▲  
1x20 cm - 3<sup>7</sup>/<sub>8</sub>"x7<sup>7</sup>/<sub>8</sub>"

LDWG Spigolo 10mm White Glossy \* ▲  
1x20 cm - 3<sup>7</sup>/<sub>8</sub>"x7<sup>7</sup>/<sub>8</sub>"

LDAM Spigolo 10mm Sand Matt \* ▲  
1x20 cm - 3<sup>7</sup>/<sub>8</sub>"x7<sup>7</sup>/<sub>8</sub>"

LDNM Spigolo 10mm Night Matt \* ▲  
1x20 cm - 3<sup>7</sup>/<sub>8</sub>"x7<sup>7</sup>/<sub>8</sub>"

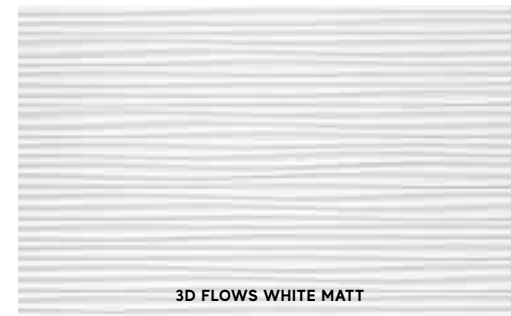

3D FLOWS WHITE MATT



3D WAVE WHITE GLOSSY



3D DUNE WHITE MATT



3D WIND WHITE MATT



3D RIBBON WHITE MATT

### DECOR RANGE

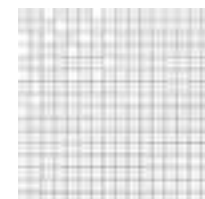

9DSM 3D Wall Design Solid White Mosaic  
30,5x30,5 cm - 12"x12"



SOLID WHITE GLOSSY

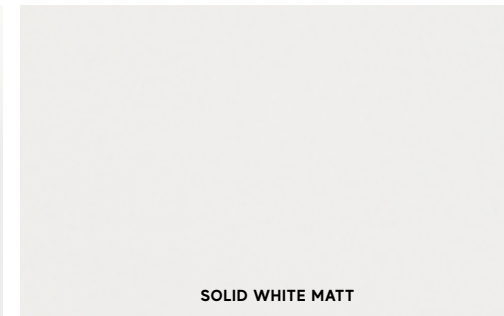

SOLID WHITE MATT



SOLID SAND MATT

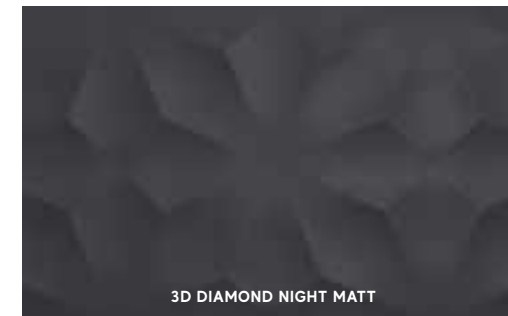

3D DIAMOND NIGHT MATT



3D ULTRA BLADE WHITE MATT

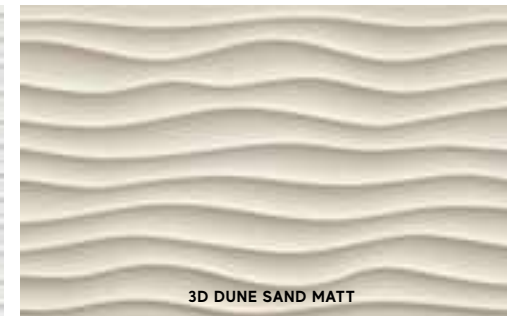

3D DUNE SAND MATT



3D DIAMOND WHITE MATT



3D ANGLE WHITE MATT



3D WAVE ARTY MILK MATT



3D FLASH WHITE MATT



3D STARS WHITE MATT



3D WAVE ARTY SUGAR MATT

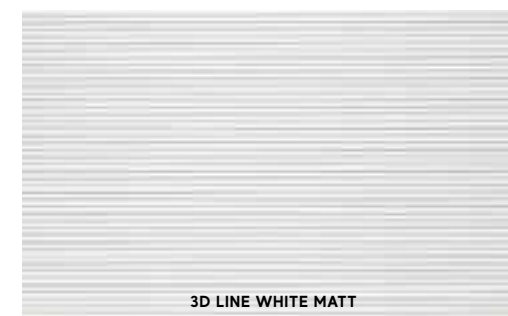

3D LINE WHITE MATT



3D BLADE WHITE MATT

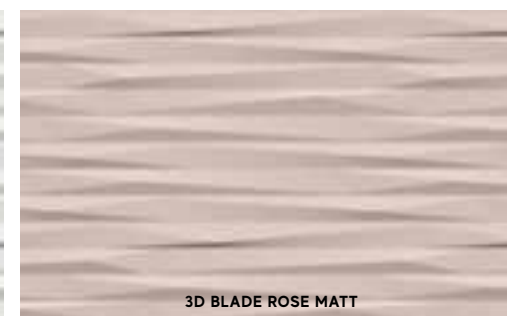

3D BLADE ROSE MATT

\* Registered Community Design

▲ These parts are supplied to order - I pezzi sono disponibili su ordinazione - Les pièces sont disponibles sur commande - Die Teile sind auf Bestellung lieferbar - Las piezas se hacen por encargo - Изготавливаются на заказ

▲ The 10 mm edge matches three-dimensional wall tiles having a 10-11 mm thickness - Lo spigolo 10 mm si abbina a rivestimenti tridimensionali di spessore 10-11 mm - Le bord 10 mm s'adapte aux revêtements tridimensionnels épaisseur 10-11 mm - Die 10 mm Kante ist mit dreidimensionalen Wandfliesen mit einer Stärke von 10-11 mm kombinierbar - La arista de 10 mm se combina con revestimientos tridimensionales de 10-11 mm de grosor - Угловой элемент 10 мм сочетается с трехмерной настенной плиткой толщиной 10-11 мм

Matte surface - Superficie matt - Surface Mat - Matte Oberfläche - Superficie Mate - Матовая поверхность

Shiny surface - Superficie lucida - Surface brillante - Glänzende Oberfläche - Superficie brillante - Глянцевая поверхность

INDEX



PRODUCT  
FINDER



SURFACE  
RANGE



COMPANY



COLLECTIONS



3D WALL

CONCRETE & RESIN LOOK

METAL LOOK

MARBLE LOOK

STONE LOOK

WOOD LOOK

LARGE SIZES



TECHNICAL  
SPECIFICATIONS



# Canone Inverso

DECOR COLLECTION by Piero Lissoni

DOWNLOAD >  
CATALOG &  
IMAGE GALLERY

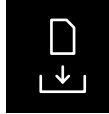

© Ceramiche Atlas Concorde



© Ceramiche Atlas Concorde



© Ceramiche Atlas Concorde



© Ceramiche Atlas Concorde

## Porcelain Tiles



**CANONE INVERSO 1**  
81x32 cm 31<sup>7</sup>/<sub>8</sub>"x12<sup>5</sup>/<sub>8</sub>"  
A19U Canone Inverso 1

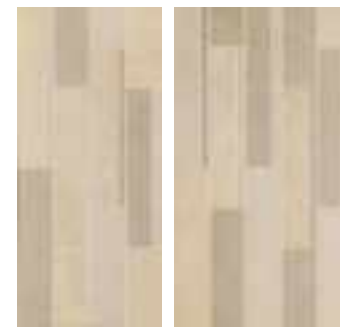

**CANONE INVERSO 2**  
59x59 cm 23"x23"  
A19V Canone Inverso 2



**CANONE INVERSO 3**  
47x147 cm 18<sup>3</sup>/<sub>4</sub>"x57<sup>7</sup>/<sub>8</sub>"  
A2US Canone Inverso 3



**CANONE INVERSO 4**  
59x78 cm 23<sup>1</sup>/<sub>4</sub>"x30<sup>3</sup>/<sub>4</sub>"  
A19X Canone Inverso 4

## SUGGESTED COMBINATIONS:

© Ceramiche Atlas Concorde

© Ceramiche Atlas Concorde

© Ceramiche Atlas Concorde

© Ceramiche Atlas Concorde

Coloured body porcelain tiles - Gres porcellanato colorato in massa - Grès cérame coloré dans la masse - Durchgefärbtes Feinsteinzeug - Gres porcelánico coloreado en masa - Керамический гранит окрашенный в массе

INDEX



PRODUCT  
FINDER



SURFACE  
RANGE



COMPANY



COLLECTIONS



- 3D WALL
- CONCRETE & RESIN LOOK
- METAL LOOK
- MARBLE LOOK
- STONE LOOK
- WOOD LOOK

LARGE SIZES



TECHNICAL  
SPECIFICATIONS



# Boost

DOWNLOAD >  
CATALOG &  
IMAGE GALLERY

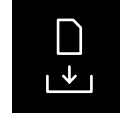

ENJOY THE  
VIDEO

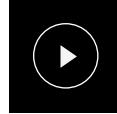

© Ceramiche Atlas Concorde



© Ceramiche Atlas Concorde



© Ceramiche Atlas Concorde

## Porcelain Tiles

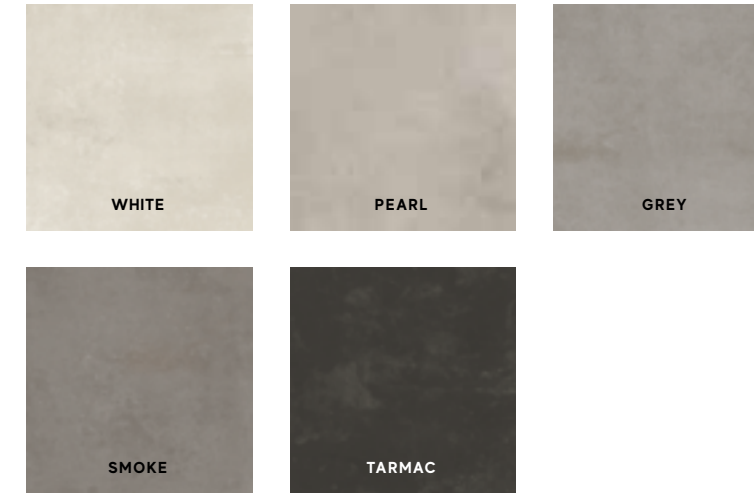

### COLOURED BODY PORCELAIN TILES - RECTIFIED MONOCALIBER

Sizes	Thickness	Surface finish
162x324 cm - 63 <sup>1</sup> / <sub>4</sub> "x127 <sup>1</sup> / <sub>2</sub> " NON RECTIFIED	± 6-12-20 mm	Hammered
160x320 cm - 63"x126"	± 6 mm	Matte R9 A
160x160 cm - 63"x63"	± 6 mm	Matte R9 A
120x278 cm - 47 <sup>1</sup> / <sub>4</sub> "x109 <sup>1</sup> / <sub>2</sub> "	± 6 mm	Matte R9 A
120x240 cm - 47 <sup>1</sup> / <sub>4</sub> "x94 <sup>1</sup> / <sub>2</sub> "	± 9 mm	Matte R10 A+B
120x120 cm - 47 <sup>1</sup> / <sub>4</sub> "x47 <sup>1</sup> / <sub>4</sub> "	± 6 mm	Matte R9 A
	± 9 mm	Matte R10 A+B
60x120 cm - 23 <sup>5</sup> / <sub>8</sub> "x47 <sup>1</sup> / <sub>4</sub> "	± 9 mm	Matte R10 A+B
75x150 cm - 29 <sup>1</sup> / <sub>2</sub> "x59"	± 9 mm	Matte R10 A+B
75x75 cm - 29 <sup>1</sup> / <sub>2</sub> "x29 <sup>1</sup> / <sub>2</sub> "	± 9 mm	Matte R10 A+B
37,5x75 cm - 14 <sup>3</sup> / <sub>8</sub> "x29 <sup>1</sup> / <sub>2</sub> "	± 9 mm	Matte R10 A+B
60x60 cm - 23 <sup>5</sup> / <sub>8</sub> "x23 <sup>5</sup> / <sub>8</sub> "	± 9 mm	Matte R10 A+B
30x60 cm - 11 <sup>3</sup> / <sub>4</sub> "x23 <sup>5</sup> / <sub>8</sub> "	± 9 mm	Matte R10 A+B

LARGE SIZES p. 390

### OUTDOOR AND WET AREAS

Sizes	Thickness	Surface finish
120x120 cm - 47 <sup>1</sup> / <sub>4</sub> "x47 <sup>1</sup> / <sub>4</sub> "	± 9 mm	Grip R11 A+B+C
120x240 cm - 47 <sup>1</sup> / <sub>4</sub> "x94 <sup>1</sup> / <sub>2</sub> "	± 20 mm	Outdoor R11 A+B+C
120x120 cm - 47 <sup>1</sup> / <sub>4</sub> "x47 <sup>1</sup> / <sub>4</sub> "	± 20 mm	Outdoor R11 A+B+C
60x120 cm - 23 <sup>5</sup> / <sub>8</sub> "x47 <sup>1</sup> / <sub>4</sub> "	± 20 mm	Outdoor R11 A+B+C
90x90 cm - 35 <sup>5</sup> / <sub>8</sub> "x35 <sup>5</sup> / <sub>8</sub> "	± 20 mm	Outdoor R11 A+B+C
60x60 cm - 23 <sup>5</sup> / <sub>8</sub> "x23 <sup>5</sup> / <sub>8</sub> "	± 20 mm	Outdoor R11 A+B+C

## Wall Tiles



### WHITEBODY WALL TILES - RECTIFIED MONOCALIBER

Sizes	Thickness	Surface finish
40x80 cm - 15 <sup>3</sup> / <sub>4</sub> "x31 <sup>1</sup> / <sub>2</sub> "	± 8,5 mm	Matte
<b>3D WALL TILES</b>		
40x80 cm - 15 <sup>3</sup> / <sub>4</sub> "x31 <sup>1</sup> / <sub>2</sub> "	± 10 mm	Matte

Coloured body porcelain tiles - Gres porcellanato colorato in massa - Grès cérame coloré dans la masse - Durchgefärbtes Feinsteinzeug - Gres porcelánico coloreado en masa - Керамический гранит окрашенный в массе  
 Whitebody wall tiles - Rivestimenti in pasta bianca - Revêtements en pâte blanche - Weißscherbige Wandfliesen - Revestimientos en pasta blanca - Настенная плитка из белой глины  
 Rectified monocaliber - Rettificato monocalibro - Rectifié mono-calibre - Geschliffen einkalibrig - Rectificado monocalibre - Ретифицированный в одном калибре  
 Non rectified - Non rettificato - Non rectifié - Nicht rektifiziert - No rectificada - Неретифицированные

INDEX



PRODUCT  
FINDER



SURFACE  
RANGE



COMPANY



COLLECTIONS



- 3D WALL
- CONCRETE & RESIN LOOK
- METAL LOOK
- MARBLE LOOK
- STONE LOOK
- WOOD LOOK

LARGE SIZES



TECHNICAL  
SPECIFICATIONS



# Boost

## Porcelain Tiles



### MATTE SURFACE



**± 6 mm**  
**160x320 cm** - 63"x126"  
 A05Z Boost White  
 A05Ø Boost Smoke  
 A68I Boost Grey  
 A68J Boost Tarmac



**± 6 mm**  
**160x160 cm** - 63"x63"  
 A0DE Boost White  
 A0DF Boost Smoke  
 A68K Boost Grey  
 A68L Boost Tarmac



**± 6 mm**  
**120x278 cm** - 47 1/4"x109 1/2"  
 A0BD Boost White  
 A0BE Boost Pearl  
 A0BF Boost Grey  
 A0BG Boost Smoke  
 A0QB Boost Tarmac



**± 6 mm**  
**120x120 cm** - 47 1/4"x47 1/4"  
 A2TK Boost White  
 A2TM Boost Pearl  
 A2TN Boost Grey  
 A2TO Boost Smoke  
 A2TP Boost Tarmac



atlasPLAN  
p. 390



**HAMMERED**  
**162x324 cm** - 63 3/4"x127 1/2"  
 NON RECTIFIED



**± 9 mm**  
**120x240 cm** - 47 1/4"x94 1/2"  
 AMGD Boost White  
 AMGE Boost Pearl  
 AMGF Boost Grey  
 AMGG Boost Smoke  
 AMGH Boost Tarmac



**± 9 mm**  
**120x120 cm** - 47 1/4"x47 1/4"  
 AMGI Boost White  
 AMGJ Boost Pearl  
 AMGK Boost Grey  
 AMGL Boost Smoke  
 AMGM Boost Tarmac



**± 9 mm**  
**60x120 cm** - 23 5/8"x47 1/4"  
 A0MO Boost White  
 A0MP Boost Pearl  
 A0MQ Boost Grey  
 A0MR Boost Smoke  
 A0MS Boost Tarmac



**± 9 mm**  
**60x60 cm** - 23 5/8"x23 5/8"  
 AMH3 Boost White  
 AMH4 Boost Pearl  
 AMH5 Boost Grey  
 AMH6 Boost Smoke  
 AMH7 Boost Tarmac



**± 9 mm**  
**30x60 cm** - 11 1/4"x23 5/8"  
 AMH8 Boost White  
 AMH9 Boost Pearl  
 AMIA Boost Grey  
 AMIC Boost Smoke  
 AMID Boost Tarmac



**± 9 mm**  
**75x150 cm** - 29 1/2"x59"  
 A7GV Boost White  
 A7GW Boost Pearl  
 A7GX Boost Grey  
 A7GY Boost Smoke  
 A7GZ Boost Tarmac



**± 9 mm**  
**75x75 cm** - 29 1/2"x29 1/2"  
 AME6 Boost White  
 AME7 Boost Pearl  
 AMGV Boost Grey  
 AMGW Boost Smoke  
 AMGX Boost Tarmac



**± 9 mm**  
**37.5x75 cm** - 14 3/4"x29 1/2"  
 A0N8 Boost White  
 A0N9 Boost Pearl  
 A0OA Boost Grey  
 A0OB Boost Smoke  
 A0OC Boost Tarmac

### GRIP SURFACE

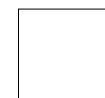

**± 9 mm**  
**120x120 cm** - 47 1/4"x47 1/4"  
 AMGN Boost White Grip  
 AMGO Boost Pearl Grip  
 AMGP Boost Grey Grip  
 AMGQ Boost Smoke Grip  
 AMGR Boost Tarmac Grip



### OUTDOOR ± 20 mm



**± 20 mm**  
**120x240 cm** - 47 1/4"x94 1/2"  
 A2RØ Boost White 20 mm  
 A2R9 Boost Grey 20 mm



**± 20 mm**  
**120x120 cm** - 47 1/4"x47 1/4"  
 AMG3 Boost White 20 mm  
 AMG5 Boost Grey 20 mm  
 AMG6 Boost Smoke 20 mm  
 AMG7 Boost Tarmac 20 mm



**± 20 mm**  
**60x120 cm** - 23 5/8"x47 1/4"  
 AL8Ø Boost White 20 mm  
 AL81 Boost Grey 20 mm  
 AL82 Boost Smoke 20 mm  
 AL83 Boost Tarmac 20 mm



**± 20 mm**  
**60x60 cm** - 23 5/8"x23 5/8"  
 A3TJ Boost White 20 mm  
 A3TK Boost Grey 20 mm  
 A3TL Boost Smoke 20 mm  
 A3TM Boost Tarmac 20 mm



**± 20 mm**  
**90x90 cm** - 35 3/8"x35 3/8"  
 AMBØ Boost White 20 mm  
 AMB1 Boost Grey 20 mm  
 AMB2 Boost Smoke 20 mm  
 AMCK Boost Tarmac 20 mm



WHITE



PEARL



GREY



SMOKE



TARMAC

**Matte surface** – Superficie matt – Surface Mat – Matte Oberfläche – Superficie Mate – Матовая поверхность  
**Grip surface** – Superficie grip – Surface grip – Grip Oberfläche – Superficie Grip – Grip поверхность  
**Outdoor** – Pavimenti da esterno – Sols d'extérieur – Bodenbeläge für Außenbereiche – Pavimentos para exteriores – Уличная плитка

INDEX



PRODUCT  
FINDER



SURFACE  
RANGE



COMPANY



COLLECTIONS



- 3D WALL
- CONCRETE & RESIN LOOK
- METAL LOOK
- MARBLE LOOK
- STONE LOOK
- WOOD LOOK

LARGE SIZES



TECHNICAL  
SPECIFICATIONS



# Boost Porcelain Tiles

## DECOR RANGE



AN6X Boost White Mosaico 30x30 - 1 1/4" x 1 1/4"  
AN6Y Boost Pearl Mosaico 30x30 - 1 1/4" x 1 1/4"  
AN6Z Boost Grey Mosaico 30x30 - 1 1/4" x 1 1/4"  
AN61 Boost Smoke Mosaico 30x30 - 1 1/4" x 1 1/4"  
AN62 Boost Tarmac Mosaico 30x30 - 1 1/4" x 1 1/4"

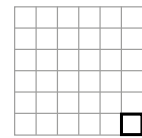

4,8x4,8 cm  
1 7/8" x 1 7/8"



AN63 Boost White Mosaico Shapes 31x33,5 - 12 1/4" x 13 1/4"  
AN64 Boost Pearl Mosaico Shapes 31x33,5 - 12 1/4" x 13 1/4"  
AN65 Boost Grey Mosaico Shapes 31x33,5 - 12 1/4" x 13 1/4"  
AN66 Boost Smoke Mosaico Shapes 31x33,5 - 12 1/4" x 13 1/4"  
AN67 Boost Tarmac Mosaico Shapes 31x33,5 - 12 1/4" x 13 1/4"

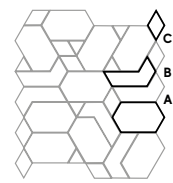

A 11,4x6,5 cm - 4 1/2" x 2 1/2"  
B 11,4x6,5 cm - 4 1/2" x 2 1/2"  
C 6,3x3,2 cm - 2 1/2" x 1 1/4"



AN68 Boost Smoke Mosaico Hex Yellow 25x28,5 - 9 7/8" x 11 1/4"  
AN69 Boost Smoke Mosaico Hex Black 25x28,5 - 9 7/8" x 11 1/4"  
AN7A Boost Tarmac Mosaico Hex Jade 25x28,5 - 9 7/8" x 11 1/4"  
AN7B Boost Tarmac Mosaico Hex Black 25x28,5 - 9 7/8" x 11 1/4"

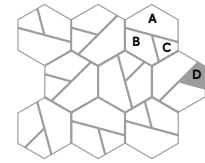

A 9,7x3,8 cm - 3 7/8" x 1 1/2"  
B 4,8x3,8 cm - 1 7/8" x 1 1/2"  
C 4,6x3,6 cm - 1 7/8" x 1 1/4"  
D 4,6x3,6 cm - 1 7/8" x 1 1/4"

## TRIM TILES p. 462



p. 455



### Battiscopa

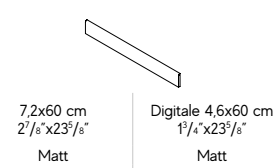

7,2x60 cm  
2 7/8" x 23 7/8"  
Matt

Digitale 4,6x60 cm  
1 7/8" x 23 7/8"  
Matt

### Gradino \*

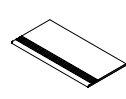

30x60 cm  
11 1/4" x 23 7/8"  
Matt

### Scalino \*

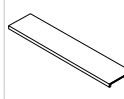

33x150 cm  
13" x 59"

### Scalino \*

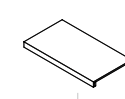

33x120 cm  
13" x 47 1/4"

33x60 cm  
13" x 23 7/8"

### Scalin Ang. \*

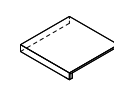

33x33 cm  
13" x 13"

### Battiscopa Sag. Scala \*



7,2x30 cm  
2 7/8" x 11 1/4"

Dx Matt Sx

### Elemento L

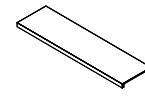

33x120 H.4 cm  
13" x 47 1/4" H.1 1/2"

Grip

\* These parts are supplied to order - I pezzi sono disponibili su ordinazione - Les pièces sont disponibles sur commande - Die Teile sind auf Bestellung lieferbar - Las piezas se hacen por encargo - Изготавливаются на заказ

The decoration can only be laid on the wall - Il decoro si può posare solo a rivestimento - Décor uniquement mural - Das Dekor kann nur an der Wand verlegt werden - La decoración se puede colocar únicamente en paredes - Декор может быть уложен только на стену.



© Ceramiche Atlas Concorde



© Ceramiche Atlas Concorde

INDEX



PRODUCT  
FINDER



SURFACE  
RANGE



COMPANY



COLLECTIONS



- 3D WALL
- CONCRETE & RESIN LOOK
- METAL LOOK
- MARBLE LOOK
- STONE LOOK
- WOOD LOOK

LARGE SIZES



TECHNICAL  
SPECIFICATIONS



# Boost Wall Tiles

## MATTE SURFACE



± 8,5 mm  
40x80 cm - 15 5/8" x 31 1/2"  
8B8W Boost White  
8B8P Boost Pearl  
8B8G Boost Grey  
8B8K Boost Smoke  
8B8S Boost Sage  
8B8R Boost Red

± 10 mm 3D WALL  
40x80 cm - 15 5/8" x 31 1/2"  
8BUW Boost 3D Urban White  
8BUP Boost 3D Urban Pearl  
8BUG Boost 3D Urban Grey

## TRIM TILES

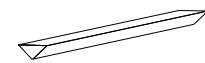

1,4x40 cm - 5/8" x 15 5/8"  
LBBW Boost White Corner 40 \*  
LBBP Boost Pearl Corner 40 \*  
LBBY Boost Grey Corner 40 \*  
LBBH Boost Smoke Corner 40 \*  
LBBT Boost Sage Corner 40 \*  
LBBQ Boost Red Corner 40 \*

▽  
1,4x1,4 cm - 5/8" x 5/8"  
AØAW Boost White Corner A.E. \*  
AØAP Boost Pearl Corner A.E. \*  
AØAG Boost Grey Corner A.E. \*  
AØAK Boost Smoke Corner A.E. \*  
AØAS Boost Sage Corner A.E. \*  
AØAR Boost Red Corner A.E. \*

## 3D TRIM TILES

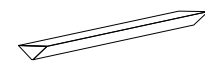

1,4x40 cm - 5/8" x 15 5/8"  
LB3W Boost White 3D Corner 40 \*  
LB3P Boost Pearl 3D Corner 40 \*  
LB3G Boost Grey 3D Corner 40 \*

\* These parts are supplied to order - I pezzi sono disponibili su ordinazione - Les pièces sont disponibles sur commande - Die Teile sind auf Bestellung lieferbar - Las piezas se hacen por encargo - Изготавливаются на заказ  
Matte surface - Superficie matt - Surface Mat - Matte Oberfläche - Superficie Mate - Матовая поверхность



## DECOR RANGE

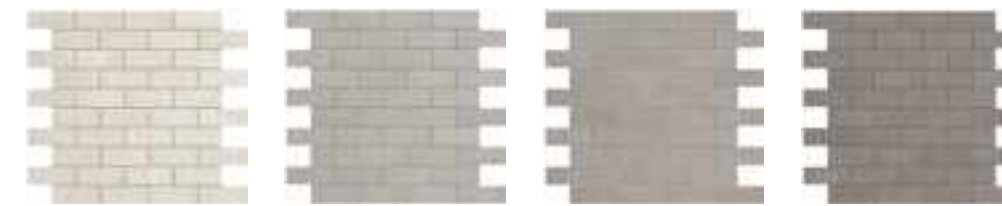

9BMW Boost White Minibrick 30,5x30,5 - 12"x12"  
9BME Boost Pearl Minibrick 30,5x30,5 - 12"x12"  
9BMY Boost Grey Minibrick 30,5x30,5 - 12"x12"  
9BMK Boost Smoke Minibrick 30,5x30,5 - 12"x12"

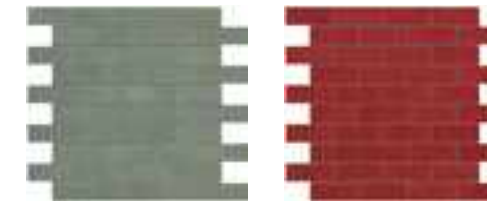

9BMM Boost Sage Minibrick 30,5x30,5 - 12"x12"  
9BMQ Boost Red Minibrick 30,5x30,5 - 12"x12"

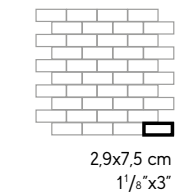

© Ceramiche Atlas Concorde

INDEX



PRODUCT  
FINDER



SURFACE  
RANGE



COMPANY



COLLECTIONS



- 3D WALL
- CONCRETE & RESIN LOOK
- METAL LOOK
- MARBLE LOOK
- STONE LOOK
- WOOD LOOK

LARGE SIZES



TECHNICAL  
SPECIFICATIONS



# Boost Natural

IN COLLABORATION WITH Matteo Brioni

DOWNLOAD >  
CATALOG &  
IMAGE GALLERY

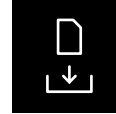

ENJOY THE  
VIDEO

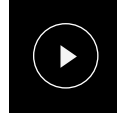

© Ceramiche Atlas Concorde



© Ceramiche Atlas Concorde



© Ceramiche Atlas Concorde

## Porcelain Tiles



### COLOURED BODY PORCELAIN TILES - RECTIFIED MONOCALIBER

Sizes	Thickness	Surface finish
162x324 cm - 63 <sup>3</sup> / <sub>4</sub> "x127 <sup>1</sup> / <sub>2</sub> " NON RECTIFIED	± 12 mm	Hammered
120x278 cm - 47 <sup>1</sup> / <sub>4</sub> "x109 <sup>1</sup> / <sub>2</sub> "	± 6 mm	Matte R9 A
120x120 cm - 47 <sup>1</sup> / <sub>4</sub> "x47 <sup>1</sup> / <sub>4</sub> "	± 9 mm	Matte R10 A+B
60x120 cm - 23 <sup>3</sup> / <sub>8</sub> "x47 <sup>1</sup> / <sub>4</sub> "	± 9 mm	Matte R10 A+B
60x60 cm - 23 <sup>3</sup> / <sub>8</sub> "x23 <sup>3</sup> / <sub>8</sub> "	± 9 mm	Matte R10 A+B
30x60 cm - 11 <sup>3</sup> / <sub>4</sub> "x23 <sup>3</sup> / <sub>8</sub> "	± 9 mm	Matte R10 A+B

LARGE SIZES p. 390

### OUTDOOR AND WET AREAS

Sizes	Thickness	Surface finish
120x120 cm - 47 <sup>1</sup> / <sub>4</sub> "x47 <sup>1</sup> / <sub>4</sub> "	± 9 mm	Grip R11 A+B+C
60x120 cm - 23 <sup>3</sup> / <sub>8</sub> "x47 <sup>1</sup> / <sub>4</sub> "	± 9 mm	Grip R11 A+B+C
120x120 cm - 47 <sup>1</sup> / <sub>4</sub> "x47 <sup>1</sup> / <sub>4</sub> "	± 20 mm	Outdoor R11 A+B+C
60x60 cm - 23 <sup>3</sup> / <sub>8</sub> "x23 <sup>3</sup> / <sub>8</sub> "	± 20 mm	Outdoor R11 A+B+C

## Wall Tiles



### WHITEBODY WALL TILES - RECTIFIED MONOCALIBER

Sizes	Thickness	Surface finish
50x120 cm - 19 <sup>5</sup> / <sub>8</sub> "x47 <sup>1</sup> / <sub>4</sub> "	± 8,5 mm	Matte
<b>3D WALL TILES</b>		
50x120 cm - 19 <sup>5</sup> / <sub>8</sub> "x47 <sup>1</sup> / <sub>4</sub> "	± 8,5 mm	Matte

Coloured body porcelain tiles – Gres porcellanato colorato in massa – Grès cérame coloré dans la masse – Durchgefärbtes Feinsteinzeug – Gres porcelánico coloreado en masa – Керамический гранит окрашенный в массе  
 Whitebody wall tiles – Rivestimenti in pasta bianca – Revêtements en pâte blanche – Weißscheibige Wandfliesen – Revestimientos en pasta blanca – Настенная плитка из белой глины  
 Rectified monocaliber – Rettificato monocalibro – Rectifié mono-calibre – Geschliffen einkalibrig – Rectificado monocalibre – Ретифицированный в одном калибре  
 Non rectified – Non rettificato – Non rectifié – Nicht rektifiziert – No rectificada – Неретифицированные

INDEX



PRODUCT  
FINDER



SURFACE  
RANGE



COMPANY



COLLECTIONS



- 3D WALL
- CONCRETE & RESIN LOOK
- METAL LOOK
- MARBLE LOOK
- STONE LOOK
- WOOD LOOK

LARGE SIZES



TECHNICAL  
SPECIFICATIONS





# Boost Natural

## Porcelain Tiles

### MATTE SURFACE



**± 6 mm**  
**120x278 cm** - 47<sup>1</sup>/<sub>4</sub>"x109<sup>1</sup>/<sub>2</sub>"  
 A67D Boost Natural Ecu  
 A67E Boost Natural Umber  
 A67F Boost Natural Coal  
 A67G Boost Natural Cobalt ▲  
 A67H Boost Natural Coral  
 A67B Boost Natural Kaolin  
 A67C Boost Natural Ash



**± 9 mm**  
**120x120 cm** - 47<sup>1</sup>/<sub>4</sub>"x47<sup>1</sup>/<sub>4</sub>"  
 A6WU Boost Natural Ecu  
 A65O Boost Natural Umber  
 A65P Boost Natural Coal  
 A65Q Boost Natural Cobalt ▲  
 A65R Boost Natural Coral  
 A65N Boost Natural Kaolin  
 A6WT Boost Natural Ash



**± 9 mm**  
**60x120 cm** - 23<sup>5</sup>/<sub>8</sub>"x47<sup>1</sup>/<sub>4</sub>"  
 A6WW Boost Natural Ecu  
 A65T Boost Natural Umber  
 A65U Boost Natural Coal  
 A65V Boost Natural Cobalt ▲  
 A65W Boost Natural Coral  
 A65S Boost Natural Kaolin  
 A6VW Boost Natural Ash



**± 9 mm**  
**60x60 cm** - 23<sup>5</sup>/<sub>8</sub>"x23<sup>5</sup>/<sub>8</sub>"  
 A66E Boost Natural Ecu  
 A66F Boost Natural Umber  
 A66G Boost Natural Coal  
 A658 Boost Natural Kaolin  
 A659 Boost Natural Ash



**± 9 mm**  
**30x60 cm** - 11<sup>3</sup>/<sub>4</sub>"x23<sup>5</sup>/<sub>8</sub>"  
 A66J Boost Natural Ecu  
 A66K Boost Natural Umber  
 A66L Boost Natural Coal  
 A66H Boost Natural Kaolin  
 A66I Boost Natural Ash

### GRIP SURFACE



**± 9 mm**  
**120x120 cm** - 47<sup>1</sup>/<sub>4</sub>"x47<sup>1</sup>/<sub>4</sub>"  
 A655 Boost Natural Ecu Grip  
 A656 Boost Natural Umber Grip  
 A657 Boost Natural Coal Grip  
 A653 Boost Natural Kaolin Grip  
 A654 Boost Natural Ash Grip



**± 9 mm**  
**60x120 cm** - 23<sup>5</sup>/<sub>8</sub>"x47<sup>1</sup>/<sub>4</sub>"  
 A65Ø Boost Natural Ecu Grip  
 A651 Boost Natural Umber Grip  
 A652 Boost Natural Coal Grip  
 A65Y Boost Natural Kaolin Grip  
 A65Z Boost Natural Ash Grip

### OUTDOOR ± 20 mm



**± 20 mm**  
**120x120 cm** - 47<sup>1</sup>/<sub>4</sub>"x47<sup>1</sup>/<sub>4</sub>"  
 A7Q9 Boost Natural Ecu 20 mm  
 A7Q7 Boost Natural Kaolin 20 mm  
 A7Q8 Boost Natural Ash 20 mm



**± 20 mm**  
**60x60 cm** - 23<sup>5</sup>/<sub>8</sub>"x23<sup>5</sup>/<sub>8</sub>"  
 A7RC Boost Natural Ecu 20 mm  
 A7RA Boost Natural Kaolin 20 mm  
 A7RB Boost Natural Ash 20 mm



Matte ± 6 mm



Matte ± 9 mm  
 Grip ± 9 mm  
 Outdoor ± 20 mm



R9 A Matte ± 6 mm  
 R10 A+B Matte ± 9 mm  
 R11 A+B+C Grip ± 9 mm  
 R11 A+B+C Outdoor ± 20 mm



V2 Slight Variation



atlasPLAN  
 p. 390



**HAMMERED**  
**162x324 cm** - 63<sup>3</sup>/<sub>4</sub>"x127<sup>1</sup>/<sub>2</sub>"  
 NON RECTIFIED



KAOLIN

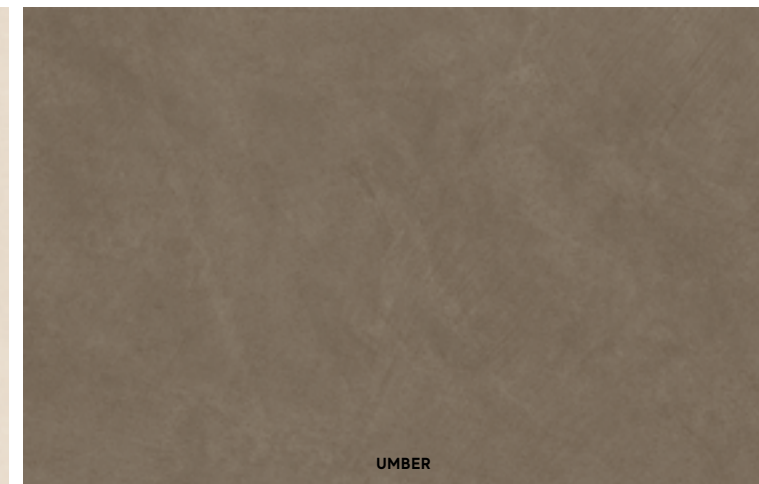

UMBER



ASH



COAL



ECRU



CORAL



COBALT

▲ Cobalt: glazed porcelain tiles / Cobalt: gres porcellanato smaltato / Cobalt: carreaux en grès cérame émaillé / Cobalt: glasierte Feinsteinzeugfliesen / Cobalt: gres porcelánico esmaltado / Cobalt: глазурованный керамогранит.

Matte surface – Superficie matt – Surface Mat – Matte Oberfläche – Superficie Mate – Матовая поверхность

Grip surface – Superficie grip – Surface grip – Grip Oberfläche – Superficie Grip – Grip поверхность

Outdoor – Pavimenti da esterno – Sols d'extérieur – Bodenbeläge für Außenbereiche – Pavimentos para exteriores – Уличная плитка

INDEX



PRODUCT  
 FINDER



SURFACE  
 RANGE



COMPANY



COLLECTIONS



3D WALL

CONCRETE & RESIN LOOK

METAL LOOK

MARBLE LOOK

STONE LOOK

WOOD LOOK

LARGE SIZES



TECHNICAL  
 SPECIFICATIONS



# Boost Natural Porcelain Tiles

## DECOR RANGE



A7CN Boost Natural Kaolin Mosaico Rhombus 36,7x33,8 - 14 1/2"x13 1/4"  
 A7CO Boost Natural Ash Mosaico Rhombus 36,7x33,8 - 14 1/2"x13 1/4"  
 A7CP Boost Natural Ecrú Mosaico Rhombus 36,7x33,8 - 14 1/2"x13 1/4"  
 A7CQ Boost Natural Umber Mosaico Rhombus 36,7x33,8 - 14 1/2"x13 1/4"



A7CR Boost Natural Coal Mosaico Rhombus 36,7x33,8 - 14 1/2"x13 1/4"  
 A7CT Boost Natural Coral Mosaico Rhombus 36,7x33,8 - 14 1/2"x13 1/4"  
 A7CS Boost Natural Cobalt Mosaico Rhombus 36,7x33,8 - 14 1/2"x13 1/4"

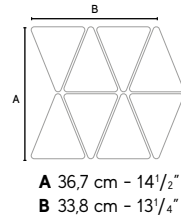

A7CF Boost Natural Kaolin Mosaico Tumbled 31x31 - 12 1/4"x12 1/4"  
 A7CG Boost Natural Ash Mosaico Tumbled 31x31 - 12 1/4"x12 1/4"  
 A7CH Boost Natural Ecrú Mosaico Tumbled 31x31 - 12 1/4"x12 1/4"  
 A7CI Boost Natural Umber Mosaico Tumbled 31x31 - 12 1/4"x12 1/4"  
 A7CJ Boost Natural Coal Mosaico Tumbled 31x31 - 12 1/4"x12 1/4"



A7CL Boost Natural Coral Mosaico Tumbled 31x31 - 12 1/4"x12 1/4"  
 A7CK Boost Natural Cobalt Mosaico Tumbled 31x31 - 12 1/4"x12 1/4"

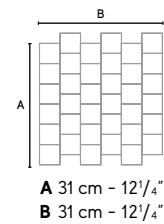

## TRIM TILES p. 462 UPEC p. 455

	Battiscopa	Gradino *	Scalino *	Scalin Ang.*	Corner * ± 6 mm	Corner A.E.* ± 6 mm	Battiscopa Sag. Scala *	Elemento L					
	7,2x120 cm 2 7/8"x47 1/4" Matt	7,2x60 cm 2 7/8"x23 3/4" Matt	30x120 cm 11 7/8"x47 1/4" Matt	30x60 cm 11 7/8"x23 3/4" Matt	33x120 cm 13"x47 1/4" Matt	33x60 cm 13"x23 3/4" Matt	33x33 cm 13"x13" Matt	1x120 cm 3/8"x47 1/4" Matt	1x1 cm 3/8"x3/8" Matt	7,2x30 cm 2 7/8"x11 1/4" Matt	DX	SX	33x120 H. 4 cm 13"x47 1/4" H.1 1/2" Grip
Kaolin	A7DV	A7DQ	A7EQ	A7EL	A7IQ	A7IL	A7IX	A7MY	A7M5	A7D9	A7D2	A7I4	
Ash	A7DW	A7DR	A7ER	A7EM	A7IR	A7IM	A7IY	A7MZ	A7M6	A7EA	A7D3	A7I5	
Ecrú	A7DX	A7DS	A7ES	A7EN	A7IS	A7IN	A7IZ	A7MØ	A7M7	A7EB	A7D4	A7I6	
Umber	A7DY	A7DT	A7ET	A7EO	A7IT	A7IO	A7IØ	A7M1	A7M8	A7EC	A7D5	A7I7	
Coal	A7DZ	A7DU	A7EU	A7EP	A7IU	A7IP	A7I1	A7M2	A7M9	A7ED	A7D6	A7I8	
Cobalt	A7DØ	-	A7EV	-	A7IV	-	A7I2	A7M3	A7NA	A7EE	A7D7	-	
Coral	A7D1	-	A7EW	-	A7IW	-	A7I3	A7M4	A7NB	A7EF	A7D8	-	

\* These parts are supplied to order - I pezzi sono disponibili su ordinazione - Les pièces sont disponibles sur commande - Die Teile sind auf Bestellung lieferbar - Las piezas se hacen por encargo - Изготавливаются на заказ



© Ceramiche Atlas Concorde

INDEX



PRODUCT  
FINDER



SURFACE  
RANGE



COMPANY



COLLECTIONS



- 3D WALL
- CONCRETE & RESIN LOOK
- METAL LOOK
- MARBLE LOOK
- STONE LOOK
- WOOD LOOK

LARGE SIZES



TECHNICAL  
SPECIFICATIONS



# Boost Natural Wall Tiles

## MATTE SURFACE



V2 Slight Variation



± 8,5 mm

50x120 cm - 19<sup>5</sup>/<sub>8</sub>"x47<sup>1</sup>/<sub>4</sub>"

A64P Boost Natural Kaolin

A64Q Boost Natural Ash

A64R Boost Natural Ecrú

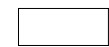

± 8,5 mm 3D WALL

50x120 cm - 19<sup>5</sup>/<sub>8</sub>"x47<sup>1</sup>/<sub>4</sub>"

A64S Boost Natural 3D Brushed Kaolin

A64T Boost Natural 3D Brushed Ash

A64U Boost Natural 3D Brushed Ecrú

A64V Boost Natural 3D Texture Kaolin

A64W Boost Natural 3D Texture Ash

A64X Boost Natural 3D Texture Ecrú

A64Y Boost Natural 3D Wave Kaolin

A64Z Boost Natural 3D Wave Ash

A64Ø Boost Natural 3D Wave Ecrú

## TRIM TILES

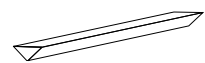

1,4x50 cm - 5<sup>5</sup>/<sub>8</sub>"x19<sup>5</sup>/<sub>8</sub>"

A641 Boost Natural Kaolin Corner 50 \*

A642 Boost Natural Ash Corner 50 \*

A643 Boost Natural Ecrú Corner 50 \*



1,4x1,4 cm - 5<sup>5</sup>/<sub>8</sub>"x5<sup>5</sup>/<sub>8</sub>"

A644 Boost Natural Kaolin Corner A.E. \*

A645 Boost Natural Ash Corner A.E. \*

A646 Boost Natural Ecrú Corner A.E. \*

## 3D TRIM TILES

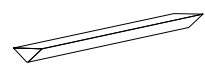

1,4x50 cm - 5<sup>5</sup>/<sub>8</sub>"x19<sup>5</sup>/<sub>8</sub>"

A7BN Boost Natural 3D Texture Kaolin Corner 50 \*

A7BO Boost Natural 3D Texture Ash Corner 50 \*

A7BP Boost Natural 3D Texture Ecrú Corner 50 \*

A7BQ Boost Natural 3D Brushed Kaolin Corner 50 \*

A7BR Boost Natural 3D Brushed Ash Corner 50 \*

A7BS Boost Natural 3D Brushed Ecrú Corner 50 \*

\* These parts are supplied to order - I pezzi sono disponibili su ordinazione  
Les pièces sont disponibles sur commande - Die Teile sind auf Bestellung lieferbar  
Las piezas se hacen por encargo - Изготавливаются на заказ

Matte surface - Superficie matt - Surface Mat  
Matte Oberfläche - Superficie Mate - Матовая поверхность



KAOLIN



3D BRUSHED KAOLIN



3D WAVE KAOLIN



3D TEXTURE KAOLIN



ASH

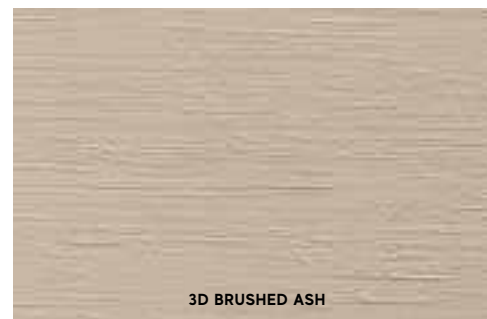

3D BRUSHED ASH



3D WAVE ASH



3D TEXTURE ASH



ECRÚ



3D BRUSHED ECRÚ

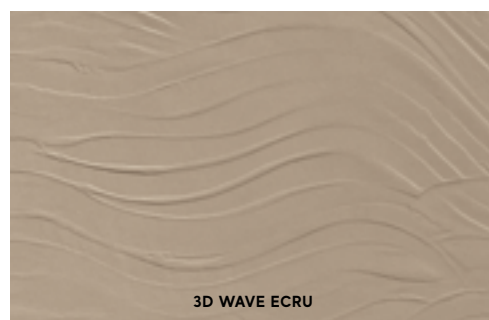

3D WAVE ECRÚ

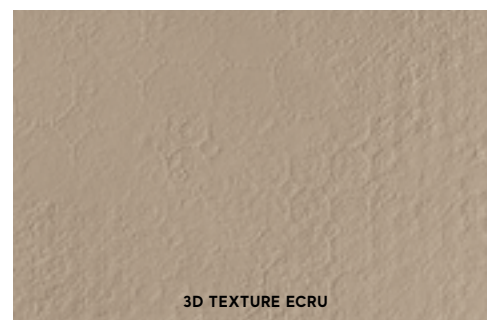

3D TEXTURE ECRÚ

## DECOR RANGE



A7JJ Boost Natural Kaolin  
Mosaico Piano ▲  
50x40,5 - 19<sup>5</sup>/<sub>8</sub>"x16"



A7JK Boost Natural Ash  
Mosaico Piano ▲  
50x40,5 - 19<sup>5</sup>/<sub>8</sub>"x16"



A7JL Boost Natural Ecrú  
Mosaico Piano ▲  
50x40,5 - 19<sup>5</sup>/<sub>8</sub>"x16"



A7JM Boost Natural Kaolin  
Mosaico Piano Mix ▲  
50x40,5 - 19<sup>5</sup>/<sub>8</sub>"x16"



A7JN Boost Natural Ash  
Mosaico Piano Mix ▲  
50x40,5 - 19<sup>5</sup>/<sub>8</sub>"x16"



A7JO Boost Natural Ecrú  
Mosaico Piano Mix ▲  
50x40,5 - 19<sup>5</sup>/<sub>8</sub>"x16"



A7JP Boost Natural Kaolin  
Mosaico Trace Mix  
30x29,2 - 11<sup>3</sup>/<sub>4</sub>"x11<sup>1</sup>/<sub>2</sub>"



A7JQ Boost Natural Ash  
Mosaico Trace Mix  
30x29,2 - 11<sup>3</sup>/<sub>4</sub>"x11<sup>1</sup>/<sub>2</sub>"



A7JR Boost Natural Ecrú  
Mosaico Trace Mix  
30x29,2 - 11<sup>3</sup>/<sub>4</sub>"x11<sup>1</sup>/<sub>2</sub>"

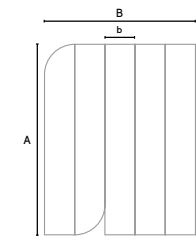

A 50 cm - 19<sup>5</sup>/<sub>8</sub>"  
b 7,95 cm - 3<sup>1</sup>/<sub>8</sub>"  
B 40,4 cm - 15<sup>7</sup>/<sub>8</sub>"

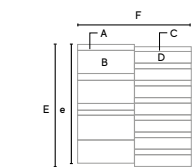

A 14,5x1,3 cm - 5<sup>7</sup>/<sub>8</sub>"x1<sup>1</sup>/<sub>2</sub>"  
B 14,5x5,9 cm - 5<sup>7</sup>/<sub>8</sub>"x2<sup>3</sup>/<sub>4</sub>"  
C 14,5x1 cm - 5<sup>7</sup>/<sub>8</sub>"x1<sup>1</sup>/<sub>8</sub>"  
D 14,5x3 cm - 5<sup>7</sup>/<sub>8</sub>"x1<sup>1</sup>/<sub>8</sub>"  
E 30,7 cm - 12<sup>1</sup>/<sub>8</sub>"  
e 30 cm - 11<sup>7</sup>/<sub>8</sub>"  
F 29,1 cm - 11<sup>1</sup>/<sub>2</sub>"

▲ For the best performance of the mosaic we recommend the use of epoxy mortars (class RG - EN 13888/ISO 13007) or decorative resins-cement, following the manufacturer's instructions. - Al fine di ottenere una resa ottimale del mosaico, è consigliato l'utilizzo di malte epossidiche (classe RG - EN 13888/ISO 13007) o di resine cementizie attenendosi alle indicazioni di utilizzo fornite dal produttore. - Afin d'obtenir un rendu optimal de la mosaïque, nous vous conseillons d'utiliser des mortiers époxy (classe RG - EN 13888/ISO 13007) ou des résines à base de ciment, en suivant les indications d'utilisation fournies par le fabricant. - Um das Mosaik optimal zur Geltung zu bringen, empfehlen wir die Verwendung von Epoxidharzfügenmörtel (Klasse RG - EN 13888/ISO 13007) oder von vergüteten Fugenmörteln unter Beachtung der vom Hersteller angegebenen Verwendungshinweise. - Para obtener un rendimiento óptimo del mosaico, se aconseja utilizar mortero epoxi (clase RG - EN 13888/ISO 13007) o resinas de cemento siguiendo las indicaciones entregadas por el fabricante. - Для наилучшего эстетического результата при укладке мозаики рекомендуется использовать эпоксидные растворы (класс RG - EN 13888/ISO 13007) или полимерцемент, соблюдая инструкции производителя.

INDEX



PRODUCT  
FINDER



SURFACE  
RANGE



COMPANY



COLLECTIONS



3D WALL

CONCRETE & RESIN LOOK

METAL LOOK

MARBLE LOOK

STONE LOOK

WOOD LOOK

LARGE SIZES



TECHNICAL  
SPECIFICATIONS



# Boost Pro

DOWNLOAD >  
CATALOG &  
IMAGE GALLERY

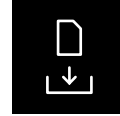

ENJOY THE  
VIDEO

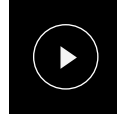

© Ceramiche Atlas Concorde



© Ceramiche Atlas Concorde



© Ceramiche Atlas Concorde

## Porcelain Tiles



### COLOURED BODY PORCELAIN TILES - RECTIFIED MONOCALIBER

Sizes	Thickness	Surface finish
160x320 cm - 63"x126"	± 6 mm	Matte R9 A
160x160 cm - 63"x63"	± 6 mm	Matte R9 A
120x278 cm - 47 1/4"x109 1/2"	± 6 mm	Matte R9 A
120x240 cm - 47 1/4"x94 1/2"	± 9 mm	Matte R10 A+B
120x120 cm - 47 1/4"x47 1/4"	± 6 mm	Matte R9 A
	± 9 mm	Matte R10 A+B
60x120 cm - 23 5/8"x47 1/4"	± 9 mm	Matte R10 A+B
75x150 cm - 29 1/2"x59"	± 9 mm	Matte R10 A+B
75x75 cm - 29 1/2"x29 1/2"	± 9 mm	Matte R10 A+B
37,5x75 cm - 14 3/4"x29 1/2"	± 9 mm	Matte R10 A+B
60x60 cm - 23 5/8"x23 5/8"	± 9 mm	Matte R10 A+B
30x60 cm - 11 3/4"x23 5/8"	± 9 mm	Matte R10 A+B

LARGE SIZES p. 390

### OUTDOOR AND WET AREAS

Sizes	Thickness	Surface finish
120x120 cm - 47 1/4"x47 1/4"	± 9 mm	Grip R11 A+B+C
120x120 cm - 47 1/4"x47 1/4"	± 20 mm	Outdoor R11 A+B+C
60x120 cm - 23 5/8"x47 1/4"	± 20 mm	Outdoor R11 A+B+C
90x90 cm - 35 3/8"x35 3/8"	± 20 mm	Outdoor R11 A+B+C
60x60 cm - 23 5/8"x23 5/8"	± 20 mm	Outdoor R11 A+B+C

## Wall Tiles



### WHITEBODY WALL TILES - RECTIFIED MONOCALIBER

Sizes	Thickness	Surface finish
40x80 cm - 15 3/4"x31 1/2"	± 8,5 mm	Matte
<b>3D WALL TILES</b>		
40x80 cm - 15 3/4"x31 1/2"	± 10 mm	Matte

Coloured body porcelain tiles - Gres porcellanato colorato in massa - Grès cérame coloré dans la masse - Durchgefärbtes Feinsteinzeug - Gres porcelánico coloreado en masa - Керамический гранит окрашенный в массе  
 Whitebody wall tiles - Rivestimenti in pasta bianca - Revêtements en pâte blanche - Weißscherbige Wandfliesen - Revestimientos en pasta blanca - Настенная плитка из белой глины  
 Rectified monocaliber - Rettificato monocalibro - Rectifié mono-calibre - Geschliffen einkalbrig - Rectificado monocalibre - Ретицированный в одном калибре

INDEX



PRODUCT  
FINDER



SURFACE  
RANGE



COMPANY



COLLECTIONS



- 3D WALL
- CONCRETE & RESIN LOOK
- METAL LOOK
- MARBLE LOOK
- STONE LOOK
- WOOD LOOK

LARGE SIZES



TECHNICAL  
SPECIFICATIONS



# Boost Pro

## Porcelain Tiles



Matte ± 6 mm



Matte ± 9 mm  
Grip ± 9 mm  
Outdoor ± 20 mm



R9 A Matte ± 6 mm  
R10 A+B Matte ± 9 mm  
R11 A+B+C Grip ± 9 mm  
R11 A+B+C Outdoor ± 20 mm



V3 Moderate  
Variation

### MATTE SURFACE



± 6 mm  
**160x320 cm** - 63"x126"  
AØQE Boost Pro Clay  
AØQF Boost Pro Taupe



± 6 mm  
**160x160 cm** - 63"x63"  
AØQG Boost Pro Clay  
AØQH Boost Pro Taupe



± 6 mm  
**120x278 cm** - 47<sup>1</sup>/<sub>4</sub>"x109<sup>1</sup>/<sub>2</sub>"  
AØCK Boost Pro Ivory  
AØCM Boost Pro Cream  
AØCN Boost Pro Clay  
AØCO Boost Pro Taupe  
AØCP Boost Pro Tobacco



± 6 mm  
**120x120 cm** - 47<sup>1</sup>/<sub>4</sub>"x47<sup>1</sup>/<sub>4</sub>"  
AØCQ Boost Pro Ivory  
AØCR Boost Pro Cream  
AØCS Boost Pro Clay  
AØCT Boost Pro Taupe  
AØCU Boost Pro Tobacco



± 9 mm  
**120x240 cm** - 47<sup>1</sup>/<sub>4</sub>"x94<sup>1</sup>/<sub>2</sub>"  
AØCF Boost Pro Ivory  
AØCG Boost Pro Cream  
AØCJ Boost Pro Clay  
AØCH Boost Pro Taupe  
AØCI Boost Pro Tobacco

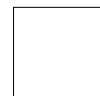

± 9 mm  
**120x120 cm** - 47<sup>1</sup>/<sub>4</sub>"x47<sup>1</sup>/<sub>4</sub>"  
AØAF Boost Pro Ivory  
AØAH Boost Pro Cream  
AØAJ Boost Pro Clay  
AØAL Boost Pro Taupe  
AØAN Boost Pro Tobacco



± 9 mm  
**60x120 cm** - 23<sup>5</sup>/<sub>8</sub>"x47<sup>1</sup>/<sub>4</sub>"  
AØBY Boost Pro Ivory  
AØBZ Boost Pro Cream  
AØBØ Boost Pro Clay  
AØB8 Boost Pro Taupe  
AØB9 Boost Pro Tobacco



± 9 mm  
**60x60 cm** - 23<sup>5</sup>/<sub>8</sub>"x23<sup>5</sup>/<sub>8</sub>"  
AØC3 Boost Pro Ivory  
AØC4 Boost Pro Cream  
AØC5 Boost Pro Clay  
AØC6 Boost Pro Taupe  
AØC7 Boost Pro Tobacco



± 9 mm  
**30x60 cm** - 11<sup>3</sup>/<sub>4</sub>"x23<sup>5</sup>/<sub>8</sub>"  
AØC8 Boost Pro Ivory  
AØC9 Boost Pro Cream  
AØDA Boost Pro Clay  
AØDB Boost Pro Taupe  
AØDC Boost Pro Tobacco

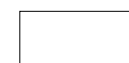

± 9 mm  
**75x150 cm** - 29<sup>1</sup>/<sub>2</sub>"x59"  
A7GØ Boost Pro Ivory  
A7G2 Boost Pro Cream  
A7G3 Boost Pro Clay  
A7G4 Boost Pro Taupe  
A7G1 Boost Pro Tobacco



± 9 mm  
**75x75 cm** - 29<sup>1</sup>/<sub>2</sub>"x29<sup>1</sup>/<sub>2</sub>"  
A28F Boost Pro Ivory  
A28G Boost Pro Cream  
A28H Boost Pro Clay  
A28I Boost Pro Taupe  
A28J Boost Pro Tobacco



± 9 mm  
**37,5x75 cm** - 14<sup>3</sup>/<sub>4</sub>"x29<sup>1</sup>/<sub>2</sub>"  
A28K Boost Pro Ivory  
A28M Boost Pro Cream  
A28N Boost Pro Clay  
A28O Boost Pro Taupe  
A28P Boost Pro Tobacco

### GRIP SURFACE

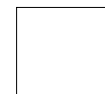

± 9 mm  
**120x120 cm** - 47<sup>1</sup>/<sub>4</sub>"x47<sup>1</sup>/<sub>4</sub>"  
AØAO Boost Pro Ivory Grip  
AØAQ Boost Pro Cream Grip  
AØBV Boost Pro Clay Grip  
AØBW Boost Pro Taupe Grip  
AØBX Boost Pro Tobacco Grip



### OUTDOOR ± 20 mm

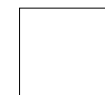

± 20 mm  
**120x120 cm** - 47<sup>1</sup>/<sub>4</sub>"x47<sup>1</sup>/<sub>4</sub>"  
A3DD Boost Pro Cream 20 mm  
A3DE Boost Pro Clay 20 mm  
A3DF Boost Pro Taupe 20 mm  
A3DH Boost Pro Tobacco 20 mm

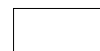

± 20 mm  
**60x120 cm** - 23<sup>5</sup>/<sub>8</sub>"x47<sup>1</sup>/<sub>4</sub>"  
A4XU Boost Pro Cream 20 mm  
A4XV Boost Pro Clay 20 mm  
A4XW Boost Pro Taupe 20 mm  
A4XX Boost Pro Tobacco 20 mm



± 20 mm  
**60x60 cm** - 23<sup>5</sup>/<sub>8</sub>"x23<sup>5</sup>/<sub>8</sub>"  
A4XQ Boost Pro Cream 20 mm  
A4XR Boost Pro Clay 20 mm  
A4XS Boost Pro Taupe 20 mm  
A4XT Boost Pro Tobacco 20 mm



± 20 mm  
**90x90 cm** - 35<sup>3</sup>/<sub>8</sub>"x35<sup>3</sup>/<sub>8</sub>"  
A4XM Boost Pro Cream 20 mm  
A4XN Boost Pro Clay 20 mm  
A4XO Boost Pro Taupe 20 mm  
A4XP Boost Pro Tobacco 20 mm



**Matte surface** – Superficie matt – Surface Mat – Matte Oberfläche – Superficie Mate – Матовая поверхность  
**Grip surface** – Superficie grip – Surface grip – Grip Oberfläche – Superficie Grip – Grip поверхность  
**Outdoor** – Pavimenti da esterno – Sols d'extérieur – Bodenbeläge für Außenbereiche – Pavimentos para exteriores – Уличная плитка



IVORY



CREAM



CLAY



TAUPE



TOBACCO

INDEX



PRODUCT  
FINDER



SURFACE  
RANGE



COMPANY



COLLECTIONS



- 3D WALL
- CONCRETE & RESIN LOOK
- METAL LOOK
- MARBLE LOOK
- STONE LOOK
- WOOD LOOK

LARGE SIZES



TECHNICAL  
SPECIFICATIONS





# Boost Pro Wall Tiles

## MATTE SURFACE





**± 8,5 mm**  
**40x80 cm - 15<sup>5</sup>/<sub>8</sub>"x31<sup>1</sup>/<sub>2</sub>"**  
 8B8I Boost Pro Ivory  
 8B8E Boost Pro Cream  
 8B8C Boost Pro Clay  
 8B8M Boost Pro Mustard  
 8B8B Boost Pro Powder Blue

**± 10 mm 3D WALL**  
**40x80 cm - 15<sup>5</sup>/<sub>8</sub>"x31<sup>1</sup>/<sub>2</sub>"**  
 8BUI Boost Pro 3D Urban Ivory  
 8BUC Boost Pro 3D Urban Clay  
 8BUB Boost Pro 3D Urban Powder Blue

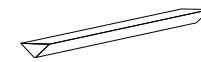

## TRIM TILES

  
**1,4x40 cm - 5<sup>5</sup>/<sub>8</sub>"x15<sup>1</sup>/<sub>2</sub>"**  
 LBBI Boost Pro Ivory Corner 40 \*  
 LBBM Boost Pro Cream Corner 40 \*  
 LBBA Boost Pro Clay Corner 40 \*  
 LBBU Boost Pro Mustard Corner 40 \*  
 LBBG Boost Pro Powder Blue Corner 40 \*

  
**1,4x1,4 cm - 5<sup>5</sup>/<sub>8</sub>"x5<sup>5</sup>/<sub>8</sub>"**  
 AØAI Boost Pro Ivory Corner A.E. \*  
 AØAE Boost Pro Cream Corner A.E. \*  
 AØAC Boost Pro Clay Corner A.E. \*  
 AØAM Boost Pro Mustard Corner A.E. \*  
 AØAB Boost Pro Powder Blue Corner A.E. \*

## 3D TRIM TILES

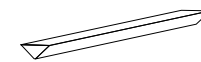
  
**1,4x40 cm - 5<sup>5</sup>/<sub>8</sub>"x15<sup>1</sup>/<sub>2</sub>"**  
 LB3I Boost Pro Ivory 3D Corner 40 \*  
 LB3C Boost Pro Clay 3D Corner 40 \*  
 LB3B Boost Pro Powder Blue 3D Corner 40 \*

\* These parts are supplied to order - I pezzi sono disponibili su ordinazione - Les pièces sont disponibles sur commande - Die Teile sind auf Bestellung lieferbar - Las piezas se hacen por encargo - Изготавливаются на заказ  
 Matte surface - Superficie matt - Surface Mat - Matte Oberfläche - Superficie Mate - Матовая поверхность

## DECOR RANGE



9B8I Boost Pro Ivory  
 Minibrick Pro Olive  
 29,7x33,3 - 11<sup>5</sup>/<sub>8</sub>"x13<sup>1</sup>/<sub>4</sub>"



9BMV Boost Pro Cream  
 Minibrick Pro Blue  
 29,7x33,3 - 11<sup>5</sup>/<sub>8</sub>"x13<sup>1</sup>/<sub>4</sub>"



9BMZ Boost Pro Clay  
 Minibrick Pro Coffee  
 29,7x33,3 - 11<sup>5</sup>/<sub>8</sub>"x13<sup>1</sup>/<sub>4</sub>"

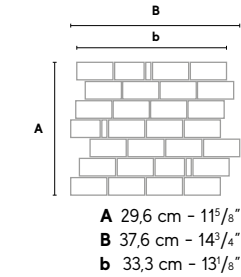

9BMT Boost Pro Mustard  
 Minibrick Pro Yellow  
 29,7x33,3 - 11<sup>5</sup>/<sub>8</sub>"x13<sup>1</sup>/<sub>4</sub>"



9BMU Boost Pro Powder Blue  
 Minibrick Pro Ocean  
 29,7x33,3 - 11<sup>5</sup>/<sub>8</sub>"x13<sup>1</sup>/<sub>4</sub>"



© Ceramiche Atlas Concorde

INDEX



PRODUCT  
FINDER



SURFACE  
RANGE



COMPANY



COLLECTIONS



- 3D WALL
- CONCRETE & RESIN LOOK
- METAL LOOK
- MARBLE LOOK
- STONE LOOK
- WOOD LOOK

LARGE SIZES



TECHNICAL  
SPECIFICATIONS



# Dwell

DOWNLOAD >  
CATALOG &  
IMAGE GALLERY

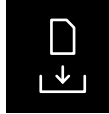

© Ceramiche Atlas Concorde



© Ceramiche Atlas Concorde



© Ceramiche Atlas Concorde

## Porcelain Tiles

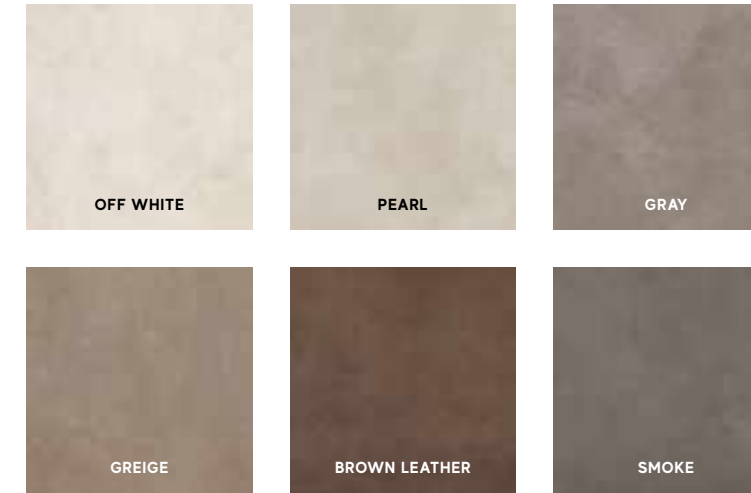

### COLOURED BODY PORCELAIN TILES - RECTIFIED MONOCALIBER

Sizes	Thickness	Surface finish
120x120 cm - 47 <sup>1</sup> / <sub>4</sub> "x47 <sup>1</sup> / <sub>4</sub> "	± 9 mm	Matte R9 A
60x60 cm - 23 <sup>5</sup> / <sub>8</sub> "x23 <sup>5</sup> / <sub>8</sub> "	± 9 mm	Matte R9 A
30x60 cm - 11 <sup>1</sup> / <sub>4</sub> "x23 <sup>5</sup> / <sub>8</sub> "	± 9 mm	Polished   Matte R9 A

LARGE SIZES p. 390

## Wall Tiles

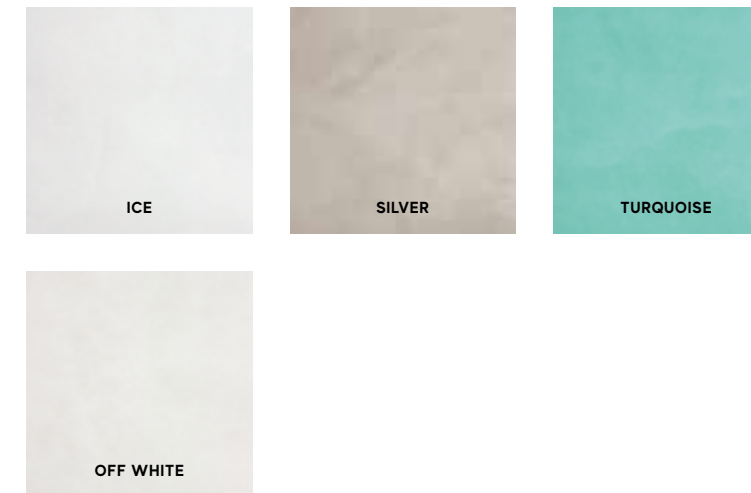

### WHITEBODY WALL TILES - RECTIFIED MONOCALIBER

Sizes	Thickness	Surface finish
40x80 cm - 15 <sup>7</sup> / <sub>4</sub> "x31 <sup>1</sup> / <sub>2</sub> "	± 8.5 mm	Shiny

Coloured body porcelain tiles - Gres porcellanato colorato in massa - Grès cérame coloré dans la masse - Durchgefärbtes Feinsteinzeug - Gres porcelánico coloreado en masa - Керамический гранит окрашенный в массе  
 Whitebody wall tiles - Rivestimenti in pasta bianca - Revêtements en pâte blanche - Weißscherbige Wandfliesen - Revestimientos en pasta blanca - Настенная плитка из белой глины  
 Rectified monocaliber - Rettificato monocalibro - Rectifié mono-calibre - Geschliffen einkalbrig - Rectificado monocalibre - Ретицированный в одном калибре

INDEX



PRODUCT  
FINDER



SURFACE  
RANGE



COMPANY



COLLECTIONS



- 3D WALL
- CONCRETE & RESIN LOOK
- METAL LOOK
- MARBLE LOOK
- STONE LOOK
- WOOD LOOK

LARGE SIZES



TECHNICAL  
SPECIFICATIONS





# Dwell

## Porcelain Tiles

### MATTE SURFACE

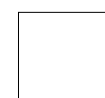

± 9 mm

120x120 cm - 47<sup>1</sup>/<sub>8</sub>"x47<sup>1</sup>/<sub>8</sub>"

- A1QJ Dwell Off White
- A1QK Dwell Gray
- A1QL Dwell Greige
- A1QM Dwell Smoke



± 9 mm

60x60 cm - 23<sup>5</sup>/<sub>8</sub>"x23<sup>5</sup>/<sub>8</sub>"

- AW8Y Dwell Off White
- AW8Z Dwell Pearl
- AW8Ø Dwell Gray
- AW81 Dwell Greige
- AW82 Dwell Brown Leather
- AW83 Dwell Smoke



± 9 mm

30x60 cm - 11<sup>7</sup>/<sub>8</sub>"x23<sup>5</sup>/<sub>8</sub>"

- DØ61 Dwell Off White
- DØ62 Dwell Pearl
- DØ63 Dwell Gray
- DØ64 Dwell Greige
- DØ65 Dwell Brown Leather
- DØ66 Dwell Smoke



Polished ± 9 mm



Matte ± 9 mm



R9 A Matte ± 9 mm



V2 Slight Variation



### POLISHED SURFACE



± 9 mm

30x60 cm - 11<sup>7</sup>/<sub>8</sub>"x23<sup>5</sup>/<sub>8</sub>"

- DØØ1 Dwell Off White Lappato
- DØØ2 Dwell Pearl Lappato
- DØØ3 Dwell Gray Lappato
- DØØ4 Dwell Greige Lappato
- DØØ5 Dwell Brown Leather Lappato
- DØØ6 Dwell Smoke Lappato



OFF WHITE



GREIGE



PEARL



BROWN LEATHER



GRAY



SMOKE

### TRIM TILES

p. 462



p. 455

- Off White
- Pearl
- Gray
- Greige
- Brown Leather
- Smoke

#### Battiscopa



7,2x60 cm  
2<sup>7</sup>/<sub>8</sub>"x23<sup>5</sup>/<sub>8</sub>"

Matt

- A1E8
- A1E9
- A1FC
- A1FD
- A1FE
- A1FF

#### Gradino \*

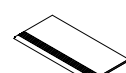

30x60 cm  
11<sup>7</sup>/<sub>8</sub>"x23<sup>5</sup>/<sub>8</sub>"

Matt

- A1KE
- A1KF
- A1KG
- A1KH
- A1KI
- A1KJ

#### Scalino \*



33x60 cm  
13"x23<sup>5</sup>/<sub>8</sub>"

Matt

- A1KW
- A1KX
- A1KY
- A1KZ
- A1KØ
- A1K1

#### Scalin Ang.\*

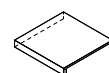

33x33 cm  
13"x13"

Matt

- |      |      |
|------|------|
| DX   | SX   |
| A1K8 | A1K2 |
| A1K9 | A1K3 |
| A1LA | A1K4 |
| A1LB | A1K5 |
| A1LC | A1K6 |
| A1LD | A1K7 |

#### Battiscopa Sag. Scala \*



7,2x30 cm  
2<sup>7</sup>/<sub>8</sub>"x11<sup>7</sup>/<sub>8</sub>"

Matt

- |      |      |
|------|------|
| DX   | SX   |
| A1LK | A1LE |
| A1LM | A1LG |
| A1LN | A1LH |
| A1LO | A1LI |
| A1LP | A1LJ |

\* These parts are supplied to order - I pezzi sono disponibili su ordinazione - Les pièces sont disponibles sur commande - Die Teile sind auf Bestellung lieferbar - Las piezas se hacen por encargo - Изготавливаются на заказ

▲ A polished finish is recommended for low-stress residential or commercial floors where anti-slip performance is not required. The surface's shine and superior ease of cleaning are the result of in-depth studies and extensive technical research aimed at ensuring its durability over time. If the product is in direct contact with the outside, use moisture and dirt absorption devices to prevent scratches. - La finitura lappata è indicata per pavimenti residenziali o commerciali poco sollecitati, laddove non siano richieste prestazioni antiscivolo. La lucentezza e l'elevata facilità di pulizia della superficie sono frutto di studi approfonditi e accurate ricerche tecniche volte a garantire la persistenza nel tempo. Se il prodotto è a diretto contatto con l'esterno, prevedere dei dispositivi di assorbimento dell'umidità e dello sporco per prevenire la formazione di graffi. - La finition semi-polie est indiquée pour les sols résidentiels ou commerciaux à faibles contraintes, où la performance antidérapante n'est pas requise. La brillance et la grande facilité de nettoyage de la surface sont le résultat d'études approfondies et de recherches techniques précises visant à assurer sa persistance dans le temps. Si le produit est en contact direct avec l'extérieur, prévoyez des dispositifs d'absorption de l'humidité et des poussières pour éviter la formation de rayures. - Die Oberflächenversion Geläpft eignet sich für Bodenbeläge in Wohnbereichen bzw. in gering beanspruchten Gewerberäumen, wenn keine Rutschfestigkeit erforderlich ist. Der Glanz und die einfache Reinigung der Oberfläche sind das Resultat eingehender technischer Studien, mit denen die langfristige Beständigkeit sichergestellt wurde. Kommt das Produkt direkt mit der externen Umgebung in Kontakt, so sind Feuchtigkeit und Schmutz mit geeigneten Mitteln aufzunehmen, um Kratzer zu vermeiden. - El acabado lapeado es adecuado para pavimentos residenciales o comerciales con poco tráfico, donde no se requiere un efecto antideslizante. El brillo y la gran facilidad de limpieza de la superficie son el resultado de profundos estudios e investigaciones técnicas precisas para asegurar su persistencia en el tiempo. Si el producto está en contacto directo con el exterior, proporcionar dispositivos de absorción de humedad y suciedad para evitar arañazos. - Лаппатированная поверхность рекомендована для полов жилых и коммерческих помещений с невысокой интенсивностью эксплуатации, в которых от покрытия не требуется характеристика: сопротивления скольжению. Блеск и легкая очищаемость являются результатом глубоких исследований, направленных на создание долговечного материала. Если плитка находится в непосредственном контакте с наружной средой, необходимо предусмотреть устройства поглощения влаги и грязи во избежание образования царапин.

Matte surface - Superficie matt - Surface Mat - Matte Oberfläche - Superficie Mate - Матовая поверхность  
Polished surface - Superficie lappata - Surface adouci - Geläppte Oberfläche - Superficie bruido - Полуполированная поверхность

INDEX



PRODUCT  
FINDER



SURFACE  
RANGE



COMPANY



COLLECTIONS



- 3D WALL
- CONCRETE & RESIN LOOK
- METAL LOOK
- MARBLE LOOK
- STONE LOOK
- WOOD LOOK

LARGE SIZES



TECHNICAL  
SPECIFICATIONS



# Dwell

## Porcelain Tiles

### DECOR RANGE



A1CX Dwell Off White  
Mosaico  
30x30 - 1 1/4" x 1 1/4"



A1CY Dwell Pearl  
Mosaico  
30x30 - 1 1/4" x 1 1/4"



A1CZ Dwell Gray  
Mosaico  
30x30 - 1 1/4" x 1 1/4"



A1CØ Dwell Greige  
Mosaico  
30x30 - 1 1/4" x 1 1/4"



A1C1 Dwell Brown Leather  
Mosaico  
30x30 - 1 1/4" x 1 1/4"



A1C2 Dwell Smoke  
Mosaico  
30x30 - 1 1/4" x 1 1/4"

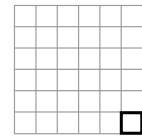

4,8x4,8 cm  
1 7/8" x 1 7/8"



A1C9 Dwell Off White  
Herringbone  
36,2x41,2 - 14 1/8" x 16 1/8"



A1DA Dwell Pearl  
Herringbone  
36,2x41,2 - 14 1/8" x 16 1/8"



A1DC Dwell Gray  
Herringbone  
36,2x41,2 - 14 1/8" x 16 1/8"



A1DD Dwell Greige  
Herringbone  
36,2x41,2 - 14 1/8" x 16 1/8"



A1DE Dwell Brown Leather  
Herringbone  
36,2x41,2 - 14 1/8" x 16 1/8"



A1DF Dwell Smoke  
Herringbone  
36,2x41,2 - 14 1/8" x 16 1/8"

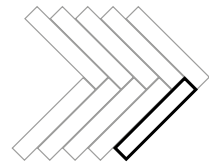

4,9x29 cm  
1 7/8" x 11 3/8"



A1YA Dwell Off White  
Listello  
8x60 - 3 1/8" x 23 3/8"



A1YB Dwell Pearl  
Listello  
8x60 - 3 1/8" x 23 3/8"



A1X8 Dwell Gray  
Listello  
8x60 - 3 1/8" x 23 3/8"



A1X9 Dwell Greige  
Listello  
8x60 - 3 1/8" x 23 3/8"



A1X7 Dwell Brown Leather  
Listello  
8x60 - 3 1/8" x 23 3/8"



A1YC Dwell Smoke  
Listello  
8x60 - 3 1/8" x 23 3/8"



INDEX



PRODUCT  
FINDER



SURFACE  
RANGE



COMPANY



COLLECTIONS



3D WALL

CONCRETE & RESIN LOOK

METAL LOOK

MARBLE LOOK

STONE LOOK

WOOD LOOK

LARGE SIZES



TECHNICAL  
SPECIFICATIONS



# Dwell

## Wall Tiles

### SHINY SURFACE



± 8.5 mm  
 40x80 cm - 15<sup>3</sup>/<sub>8</sub>"x31<sup>1</sup>/<sub>2</sub>"  
 8DWH Dwell Off White  
 8DWC Dwell Ice  
 8DWL Dwell Silver  
 8DWQ Dwell Turquoise



ICE



SILVER



OFF WHITE



TURQUOISE

### TRIM TILES

LDPI Dwell Ice Spigolo 0,8x20 cm - 3 <sup>1</sup> / <sub>8</sub> "x7 <sup>1</sup> / <sub>8</sub> "	A1DI Dwell Ice Spigolo A.E. 0,8x0,8 cm - 3 <sup>1</sup> / <sub>8</sub> "x3 <sup>1</sup> / <sub>8</sub> "
LDPS Dwell Silver Spigolo 0,8x20 cm - 3 <sup>1</sup> / <sub>8</sub> "x7 <sup>1</sup> / <sub>8</sub> "	A1DS Dwell Silver Spigolo A.E. 0,8x0,8 cm - 3 <sup>1</sup> / <sub>8</sub> "x3 <sup>1</sup> / <sub>8</sub> "
LDPT Dwell Turquoise Spigolo 0,8x20 cm - 3 <sup>1</sup> / <sub>8</sub> "x7 <sup>1</sup> / <sub>8</sub> "	A1DT Dwell Turquoise Spigolo A.E. 0,8x0,8 cm - 3 <sup>1</sup> / <sub>8</sub> "x3 <sup>1</sup> / <sub>8</sub> "
LDPW Dwell Off White Spigolo 0,8x20 cm - 3 <sup>1</sup> / <sub>8</sub> "x7 <sup>1</sup> / <sub>8</sub> "	A1DW Dwell Off White Spigolo A.E. 0,8x0,8 cm - 3 <sup>1</sup> / <sub>8</sub> "x3 <sup>1</sup> / <sub>8</sub> "

### DECOR RANGE

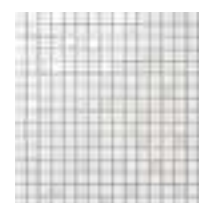

9DQI Dwell Ice  
Mosaico Q  
30,5x30,5 - 12"x12"

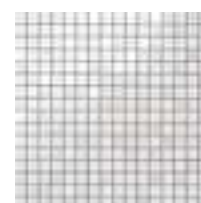

9DQW Dwell Off White  
Mosaico Q  
30,5x30,5 - 12"x12"

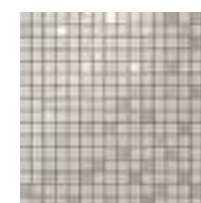

9DQS Dwell Silver  
Mosaico Q  
30,5x30,5 - 12"x12"



9DQT Dwell Turquoise  
Mosaico Q  
30,5x30,5 - 12"x12"

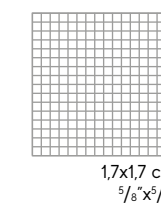

1,7x1,7 cm  
2<sup>3</sup>/<sub>8</sub>"x2<sup>3</sup>/<sub>8</sub>"



9DLI Dwell Ice  
Mosaico L  
30,5x26 - 12"x10<sup>1</sup>/<sub>4</sub>"



9DLW Dwell Off White  
Mosaico L  
30,5x26 - 12"x10<sup>1</sup>/<sub>4</sub>"



9DLS Dwell Silver  
Mosaico L  
30,5x26 - 12"x10<sup>1</sup>/<sub>4</sub>"



9DLT Dwell Turquoise  
Mosaico L  
30,5x26 - 12"x10<sup>1</sup>/<sub>4</sub>"



1x26 cm  
3<sup>1</sup>/<sub>8</sub>"x10<sup>1</sup>/<sub>4</sub>"



9DBV Dwell Silver  
Mosaico Brick  
30,5x30,5 - 12"x12"

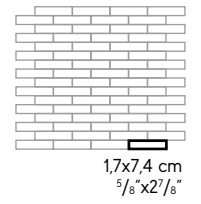

1,7x7,4 cm  
2<sup>3</sup>/<sub>8</sub>"x2<sup>3</sup>/<sub>8</sub>"



9DMT Dwell Turquoise  
Mosaico Mix  
30,5x30,5 - 12"x12"

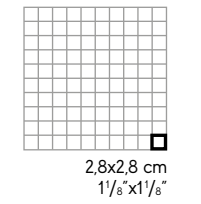

2,8x2,8 cm  
1<sup>1</sup>/<sub>8</sub>"x1<sup>1</sup>/<sub>8</sub>"

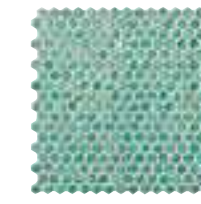

6DHT Dwell Turquoise  
Hexagon Gold  
30x28,5 - 11<sup>1</sup>/<sub>4</sub>"x11<sup>1</sup>/<sub>4</sub>"

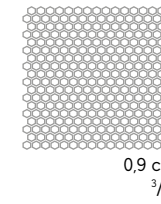

0,9 cm  
3<sup>1</sup>/<sub>8</sub>"



6DMU Dwell Turquoise Mix 4  
20x40 - 7<sup>1</sup>/<sub>8</sub>"x15<sup>1</sup>/<sub>4</sub>"

INDEX



PRODUCT  
FINDER



SURFACE  
RANGE



COMPANY



COLLECTIONS



- 3D WALL
- CONCRETE & RESIN LOOK
- METAL LOOK
- MARBLE LOOK
- STONE LOOK
- WOOD LOOK

LARGE SIZES



TECHNICAL  
SPECIFICATIONS



# Mark



© Ceramiche Atlas Concorde

## Porcelain Tiles

### COLOURED BODY PORCELAIN TILES - RECTIFIED MONOCALIBER

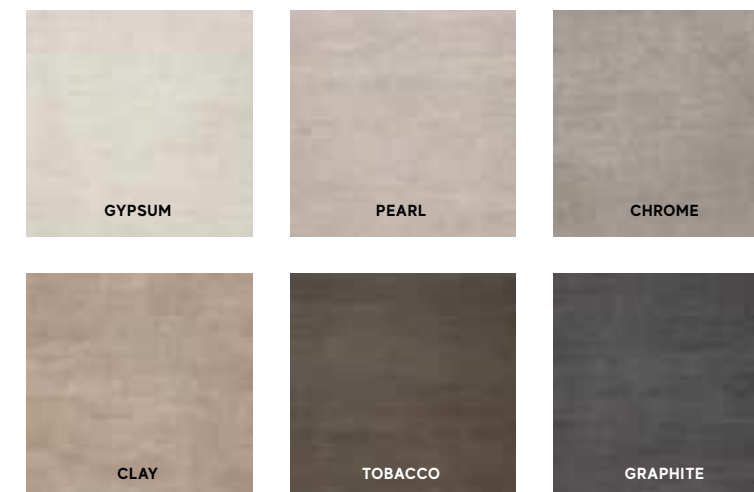

Sizes	Thickness	Surface finish
60x60 cm - 23 <sup>5</sup> / <sub>8</sub> "x23 <sup>5</sup> / <sub>8</sub> "	± 9 mm	Matte R10 A
30x60 cm - 11 <sup>1</sup> / <sub>4</sub> "x23 <sup>5</sup> / <sub>8</sub> "	± 9 mm	Matte R10 A

Coloured body porcelain tiles - Gres porcellanato colorato in massa - Grès cérame coloré dans la masse - Durchgefärbtes Feinsteinzeug - Gres porcelánico coloreado en masa - Керамический гранит окрашенный в массе

INDEX



PRODUCT  
FINDER



SURFACE  
RANGE



COMPANY



COLLECTIONS



- 3D WALL
- CONCRETE & RESIN LOOK
- METAL LOOK
- MARBLE LOOK
- STONE LOOK
- WOOD LOOK

LARGE SIZES



TECHNICAL  
SPECIFICATIONS



# Mark

## Porcelain Tiles

### MATTE SURFACE



± 9 mm

60x60 cm - 23<sup>5</sup>/<sub>8</sub>" x 23<sup>5</sup>/<sub>8</sub>"

AS6N Mark Gypsum  
AS6O Mark Pearl  
AS6P Mark Chrome  
AS6Q Mark Clay  
AS6S Mark Tobacco  
AS6T Mark Graphite



± 9 mm

30x60 cm - 11<sup>3</sup>/<sub>4</sub>" x 23<sup>5</sup>/<sub>8</sub>"

DØ89 Mark Gypsum  
DØ90 Mark Pearl  
DØ91 Mark Chrome  
DØ92 Mark Clay  
DØ93 Mark Tobacco  
DØ94 Mark Graphite



GYP SUM



PEARL



CLAY



CHROME



TOBACCO

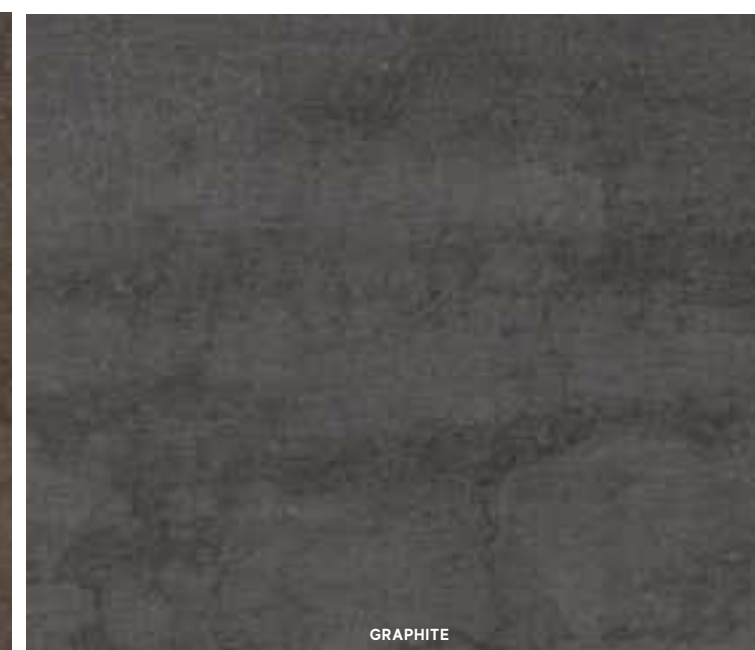

GRAPHITE

### TRIM TILES

p. 462



p. 455



### Battiscopa

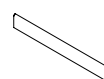

7,2x60 cm  
2<sup>7</sup>/<sub>8</sub>" x 23<sup>5</sup>/<sub>8</sub>"

Matt

AMY9  
AMZA  
AMZC  
AMZD  
AMZE  
AMZF

### Gradino \*

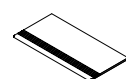

30x60 cm  
11<sup>3</sup>/<sub>4</sub>" x 23<sup>5</sup>/<sub>8</sub>"

Matt

AMØS  
AMØT  
AMØU  
AMØV  
AMØW  
AMØX

### Scalino \*

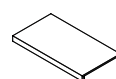

33x60 cm  
13" x 23<sup>5</sup>/<sub>8</sub>"

Matt

AMIK  
AMIL  
AMIM  
AMIN  
AMIO  
AMIP

### Scalin Ang.\*

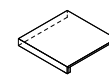

33x33 cm  
13" x 13"

Matt

AM1Q  
AM1R  
AM1S  
AM1T  
AM1U  
AM1V

### Battiscopa Sag. Scala \*



7,2x30 cm  
2<sup>7</sup>/<sub>8</sub>" x 11<sup>3</sup>/<sub>4</sub>"

Matt

DX	SX
AMZO	AMZW
AMZQ	AM1W
AMZR	AMIX
AMZS	AM1Y
AMZU	ANQY
AMZV	AM1Z

\* These parts are supplied to order - I pezzi sono disponibili su ordinazione - Les pièces sont disponibles sur commande - Die Teile sind auf Bestellung lieferbar - Las piezas se hacen por encargo - Изготавливаются на заказ

Matte surface - Superficie matt - Surface Mat - Matte Oberfläche - Superficie Mate - Матовая поверхность

INDEX



PRODUCT  
FINDER



SURFACE  
RANGE



COMPANY



COLLECTIONS



3D WALL  
CONCRETE & RESIN LOOK  
METAL LOOK  
MARBLE LOOK  
STONE LOOK  
WOOD LOOK

LARGE SIZES



TECHNICAL  
SPECIFICATIONS



# Mark

## Porcelain Tiles

### DECOR RANGE



AMX9 Mark Gypsum Mosaico Matt 30x30 - 1<sup>1</sup>/<sub>8</sub>"x1<sup>1</sup>/<sub>8</sub>"  
 AMYA Mark Pearl Mosaico Matt 30x30 - 1<sup>1</sup>/<sub>8</sub>"x1<sup>1</sup>/<sub>8</sub>"  
 AMYC Mark Clay Mosaico Matt 30x30 - 1<sup>1</sup>/<sub>8</sub>"x1<sup>1</sup>/<sub>8</sub>"



AMYB Mark Chrome Mosaico Matt 30x30 - 1<sup>1</sup>/<sub>8</sub>"x1<sup>1</sup>/<sub>8</sub>"  
 AMYD Mark Tobacco Mosaico Matt 30x30 - 1<sup>1</sup>/<sub>8</sub>"x1<sup>1</sup>/<sub>8</sub>"  
 AMYE Mark Graphite Mosaico Matt 30x30 - 1<sup>1</sup>/<sub>8</sub>"x1<sup>1</sup>/<sub>8</sub>"

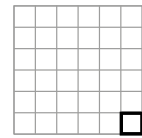

4,8x4,8 cm  
 1<sup>7</sup>/<sub>8</sub>"x1<sup>7</sup>/<sub>8</sub>"



AM2K Mark Gypsum Mosaico Esagono 30x35 - 1<sup>1</sup>/<sub>4</sub>"x1<sup>3</sup>/<sub>4</sub>"  
 AM2L Mark Pearl Mosaico Esagono 30x35 - 1<sup>1</sup>/<sub>4</sub>"x1<sup>3</sup>/<sub>4</sub>"  
 AM2N Mark Clay Mosaico Esagono 30x35 - 1<sup>1</sup>/<sub>4</sub>"x1<sup>3</sup>/<sub>4</sub>"



AM2M Mark Chrome Mosaico Esagono 30x35 - 1<sup>1</sup>/<sub>4</sub>"x1<sup>3</sup>/<sub>4</sub>"  
 AM2O Mark Tobacco Mosaico Esagono 30x35 - 1<sup>1</sup>/<sub>4</sub>"x1<sup>3</sup>/<sub>4</sub>"  
 AM2P Mark Graphite Mosaico Esagono 30x35 - 1<sup>1</sup>/<sub>4</sub>"x1<sup>3</sup>/<sub>4</sub>"

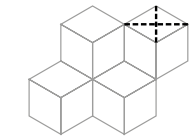

10x17 cm  
 3<sup>7</sup>/<sub>8</sub>"x6<sup>1</sup>/<sub>4</sub>"



AM2R Mark Gypsum Mosaico Brick 3D 29x59 - 1<sup>1</sup>/<sub>8</sub>"x23<sup>3</sup>/<sub>8</sub>"  
 AM2S Mark Pearl Mosaico Brick 3D 29x59 - 1<sup>1</sup>/<sub>8</sub>"x23<sup>3</sup>/<sub>8</sub>"



AM2U Mark Clay Mosaico Brick 3D 29x59 - 1<sup>1</sup>/<sub>8</sub>"x23<sup>3</sup>/<sub>8</sub>"  
 AM2T Mark Chrome Mosaico Brick 3D 29x59 - 1<sup>1</sup>/<sub>8</sub>"x23<sup>3</sup>/<sub>8</sub>"



AM2V Mark Tobacco Mosaico Brick 3D 29x59 - 1<sup>1</sup>/<sub>8</sub>"x23<sup>3</sup>/<sub>8</sub>"  
 AM2W Mark Graphite Mosaico Brick 3D 29x59 - 1<sup>1</sup>/<sub>8</sub>"x23<sup>3</sup>/<sub>8</sub>"



A 19,9x7,1 cm - 7<sup>7</sup>/<sub>8</sub>"x2<sup>7</sup>/<sub>8</sub>"  
 B 38,6x7,1 cm - 15<sup>1</sup>/<sub>8</sub>"x2<sup>7</sup>/<sub>8</sub>"



AMYR Mark Gypsum Mosaico Brick 30x60 - 1<sup>1</sup>/<sub>4</sub>"x23<sup>3</sup>/<sub>8</sub>"  
 AMYS Mark Pearl Mosaico Brick 30x60 - 1<sup>1</sup>/<sub>4</sub>"x23<sup>3</sup>/<sub>8</sub>"



AMYU Mark Clay Mosaico Brick 30x60 - 1<sup>1</sup>/<sub>4</sub>"x23<sup>3</sup>/<sub>8</sub>"  
 AMYT Mark Chrome Mosaico Brick 30x60 - 1<sup>1</sup>/<sub>4</sub>"x23<sup>3</sup>/<sub>8</sub>"



AMYV Mark Tobacco Mosaico Brick 30x60 - 1<sup>1</sup>/<sub>4</sub>"x23<sup>3</sup>/<sub>8</sub>"  
 AMYW Mark Graphite Mosaico Brick 30x60 - 1<sup>1</sup>/<sub>4</sub>"x23<sup>3</sup>/<sub>8</sub>"

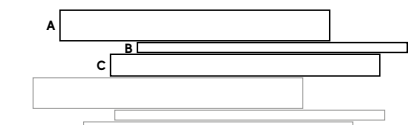

A 4,7x59,5 cm - 1<sup>7</sup>/<sub>8</sub>"x11<sup>1</sup>/<sub>8</sub>"  
 B 2,5x59,5 cm - 1"x23<sup>3</sup>/<sub>8</sub>"  
 C 7,1x59,5 cm - 2<sup>7</sup>/<sub>8</sub>"x23<sup>3</sup>/<sub>8</sub>"

▲ Multi-thickness mosaic, close joint installation without grouting. - Mosaico multispessore, posa senza stuccatura a giunto unito. - Mosaïque multi-épaisseur, pose sans mastic avec joint nul. - Mosaik mit verschiedenen Stärken, fugenlose Verlegung ohne Mörtel. - Mosaico multiespesor, colocación sin mástico y sin juntas. - Мозаика разной толщины, укладка встык без затирки швов.

■ The decoration can only be laid on the wall. - Il decoro si può posare solo a rivestimento. - Décor uniquement mural. - Das Dekor kann nur an der Wand verlegt werden. - La decoración se puede colocar únicamente en paredes. - Декор может быть уложен только на стену.

INDEX



PRODUCT FINDER



SURFACE RANGE



COMPANY



COLLECTIONS



- 3D WALL
- CONCRETE & RESIN LOOK
- METAL LOOK
- MARBLE LOOK
- STONE LOOK
- WOOD LOOK

LARGE SIZES



TECHNICAL SPECIFICATIONS



# Mek

DOWNLOAD >  
CATALOG &  
IMAGE GALLERY

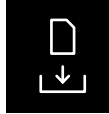

© Ceramiche Atlas Concorde



© Ceramiche Atlas Concorde



© Ceramiche Atlas Concorde

## Porcelain Tiles

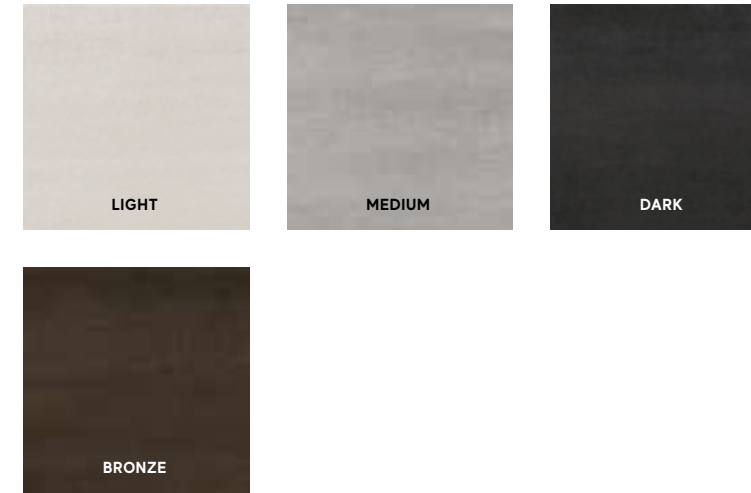

### COLOURED BODY PORCELAIN TILES - RECTIFIED MONOCALIBER

Sizes	Thickness	Surface finish
45x90 cm - 17 <sup>3</sup> / <sub>4</sub> "x35 <sup>5</sup> / <sub>8</sub> "	± 9 mm	Matte R10 A
60x60 cm - 23 <sup>5</sup> / <sub>8</sub> "x23 <sup>5</sup> / <sub>8</sub> "	± 9 mm	Matte R10 A
30x60 cm - 11 <sup>1</sup> / <sub>4</sub> "x23 <sup>5</sup> / <sub>8</sub> "	± 9 mm	Matte R10 A

## Wall Tiles



### WHITEBODY WALL TILES - RECTIFIED MONOCALIBER

Sizes	Thickness	Surface finish
50x120 cm - 19 <sup>5</sup> / <sub>8</sub> "x47 <sup>1</sup> / <sub>4</sub> "	± 8,5 mm	Matte
<b>3D WALL TILES</b>		
50x120 cm - 19 <sup>5</sup> / <sub>8</sub> "x47 <sup>1</sup> / <sub>4</sub> "	± 11 mm	Matte

INDEX



PRODUCT  
FINDER



SURFACE  
RANGE



COMPANY



COLLECTIONS



- 3D WALL
- CONCRETE & RESIN LOOK
- METAL LOOK
- MARBLE LOOK
- STONE LOOK
- WOOD LOOK

LARGE SIZES



TECHNICAL  
SPECIFICATIONS



Coloured body porcelain tiles - Gres porcellanato colorato in massa - Grès cérame coloré dans la masse - Durchgefärbtes Feinsteinzeug - Gres porcelánico coloreado en masa - Керамический гранит окрашенный в массе  
Whitebody wall tiles - Rivestimenti in pasta bianca - Revêtements en pâte blanche - Weißscherbige Wandfliesen - Revestimientos en pasta blanca - Настенная плитка из белой глины  
Rectified monocaliber - Rettificato monocalibro - Rectifié mono-calibre - Geschliffen einkalbrig - Rectificado monocalibre - Ретифицированный в одном калибре

# Mek

## Porcelain Tiles

### MATTE SURFACE



± 9 mm

**60x60 cm** - 23<sup>3/8</sup>"x23<sup>3/8</sup>"  
 AUAA Mek Light  
 AUAC Mek Medium  
 AUAD Mek Bronze  
 AUAF Mek Dark



± 9 mm

**30x60 cm** - 11<sup>3/4</sup>"x23<sup>3/8</sup>"  
 D226 Mek Light  
 D227 Mek Medium  
 D228 Mek Bronze  
 D229 Mek Dark



± 9 mm

**45x90 cm** - 17<sup>3/4</sup>"x35<sup>3/8</sup>"  
 AT96 Mek Light  
 AT97 Mek Medium  
 AT98 Mek Bronze  
 AT99 Mek Dark



Matte ± 9 mm



R10 A Matte ± 9 mm



V2 Slight Variation

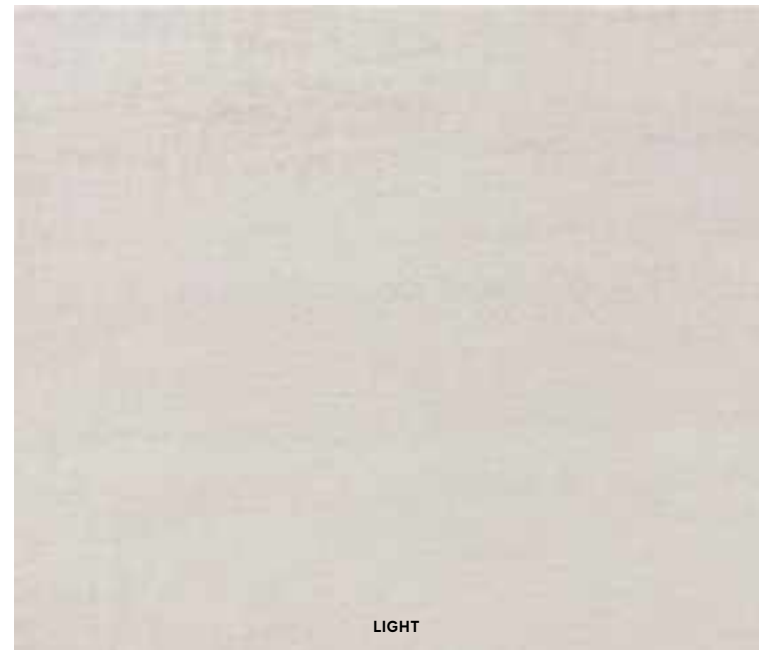

LIGHT



MEDIUM



BRONZE



DARK

### TRIM TILES

p. 462  
 p. 455

- Light
- Medium
- Bronze
- Dark

#### Battiscopa

7,2x60 cm  
 2<sup>7/8</sup>"x23<sup>3/8</sup>"  
 Matt

- AMPN
- AMPO
- AMPQ
- AMPR

#### Gradino \*

30x60 cm  
 11<sup>3/4</sup>"x23<sup>3/8</sup>"  
 Matt

- AMPY
- AMPV
- AMPW
- AMPX

#### Scalino \*

33x60 cm  
 13"x23<sup>3/8</sup>"  
 Matt

- AMP9
- AMQA
- AMQB
- AMQC

#### Scalin Ang.\*

33x33 cm  
 13"x13"  
 Matt

- |      |      |
|------|------|
| DX   | SX   |
| AMQH | AMQL |
| AMQI | AMQM |
| AMQJ | AMQN |
| AMQK | AMQO |

#### Battiscopa Sag. Scala \*

7,2x30 cm  
 2<sup>7/8</sup>"x11<sup>3/8</sup>"  
 Matt

- |      |      |
|------|------|
| DX   | SX   |
| AMQP | AMQT |
| AMQQ | AMQU |
| AMQR | AMQV |
| AMQS | AMQW |

\* These parts are supplied to order - I pezzi sono disponibili su ordinazione - Les pièces sont disponibles sur commande - Die Teile sind auf Bestellung lieferbar - Las piezas se hacen por encargo - Изготавливаются на заказ  
 Matte surface - Superficie matt - Surface Mat - Matte Oberfläche - Superficie Mate - Матовая поверхность

INDEX



PRODUCT  
 FINDER



SURFACE  
 RANGE



COMPANY



COLLECTIONS



- 3D WALL
- CONCRETE & RESIN LOOK
- METAL LOOK
- MARBLE LOOK
- STONE LOOK
- WOOD LOOK

LARGE SIZES



TECHNICAL  
 SPECIFICATIONS





# Mek

## Porcelain Tiles

### DECOR RANGE

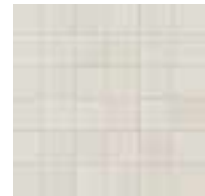

AMKY Mek Light  
Mosaico  
30x30 - 1 1/4" x 1 1/4"



AMKZ Mek Medium  
Mosaico  
30x30 - 1 1/4" x 1 1/4"

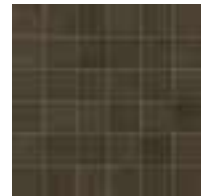

AMKØ Mek Bronze  
Mosaico  
30x30 - 1 1/4" x 1 1/4"

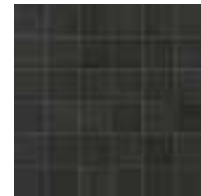

AMK1 Mek Dark  
Mosaico  
30x30 - 1 1/4" x 1 1/4"

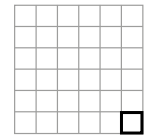

4,8x4,8 cm  
1 7/8" x 1 7/8"



AMKJ Mek Light  
Mosaico Zip  
27x28 - 10 5/8" x 11"



AMKK Mek Medium  
Mosaico Zip  
27x28 - 10 5/8" x 11"



AMKN Mek Bronze  
Mosaico Zip  
27x28 - 10 5/8" x 11"



AMKO Mek Dark  
Mosaico Zip  
27x28 - 10 5/8" x 11"

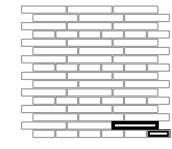

1,5x9,2 cm / 5/8" x 3 7/8"  
1,5x4,5 cm / 5/8" x 1 3/4"



AMKQ Mek Light  
Mosaico Prisma  
36x36 - 14 1/8" x 14 1/8"



AMKV Mek Medium  
Mosaico Prisma  
36x36 - 14 1/8" x 14 1/8"



AMKW Mek Bronze  
Mosaico Prisma  
36x36 - 14 1/8" x 14 1/8"



AMKX Mek Dark  
Mosaico Prisma  
36x36 - 14 1/8" x 14 1/8"

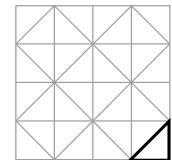

8,9x8,9 cm  
3 1/2" x 3 1/2"



AMKG Mek Light  
Esagono  
30x35 - 1 1/4" x 13 3/4"



AMKF Mek Medium  
Esagono  
30x35 - 1 1/4" x 13 3/4"



AMKH Mek Bronze  
Esagono  
30x35 - 1 1/4" x 13 3/4"



AMK1 Mek Dark  
Esagono  
30x35 - 1 1/4" x 13 3/4"

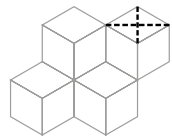

10x17 cm  
3 7/8" x 6 3/4"



AMPJ Mek  
Rombo Gold ▲  
10x17 - 3 7/8" x 6 3/4"

▲ **Loose tiles to add freely to the Esagono Mosaic.** - Tessere sfuse da inserire liberamente all'interno di Mosaico Esagono. - Pièces à utiliser librement pour Mosaico Esagono. - Lose Steinchen, die frei innerhalb des Sechseckigen Mosaiks eingefügt werden können. - Teselas a granel para insertar libremente en el interior de Mosaico Hexagonal. - Мозаичные элементы для произвольного включения в мозаику Esagono.

■ **The decoration can only be laid on the wall.** - Il decoro si può posare solo a rivestimento - Décor uniquement mural - Das Dekor kann nur an der Wand verlegt werden. - La decoración se puede colocar únicamente en paredes - Декор может быть уложен только на стену.



© Ceramiche Atlas Concorde



© Ceramiche Atlas Concorde

INDEX



PRODUCT  
FINDER



SURFACE  
RANGE



COMPANY



COLLECTIONS



- 3D WALL
- CONCRETE & RESIN LOOK
- METAL LOOK
- MARBLE LOOK
- STONE LOOK
- WOOD LOOK

LARGE SIZES



TECHNICAL  
SPECIFICATIONS



# Mek Wall Tiles

## MATTE SURFACE



± 8,5 mm

50x120 cm - 19<sup>5</sup>/<sub>8</sub>"x47<sup>1</sup>/<sub>4</sub>"

A4SQ Mek Light

A4SR Mek Medium

A4SS Mek Rose

A4SP Mek Blue



± 11 mm 3D WALL

50x120 cm - 19<sup>5</sup>/<sub>8</sub>"x47<sup>1</sup>/<sub>4</sub>"

A4S8 Mek 3D Fold Light

A4R9 Mek 3D Fold Medium

A4S9 Mek 3D Ultra Blade Rose

A4TA Mek 3D Ultra Blade Blue

## TRIM TILES

LMPK Mek Light Spigolo

0,8x25 cm - 3<sup>1</sup>/<sub>8</sub>"x8<sup>7</sup>/<sub>8</sub>"

AMKL Mek Light Spigolo A.E.

0,8x0,8 cm - 3<sup>1</sup>/<sub>8</sub>"x2<sup>1</sup>/<sub>8</sub>"

LMPH Mek Medium Spigolo

0,8x25 cm - 3<sup>1</sup>/<sub>8</sub>"x8<sup>7</sup>/<sub>8</sub>"

AMKM Mek Medium Spigolo A.E.

0,8x0,8 cm - 3<sup>1</sup>/<sub>8</sub>"x2<sup>1</sup>/<sub>8</sub>"

LMPQ Mek Rose Spigolo

0,8x25 cm - 3<sup>1</sup>/<sub>8</sub>"x8<sup>7</sup>/<sub>8</sub>"

AMKR Mek Rose Spigolo A.E.

0,8x0,8 cm - 3<sup>1</sup>/<sub>8</sub>"x2<sup>1</sup>/<sub>8</sub>"

LMPU Mek Blue Spigolo

0,8x25 cm - 3<sup>1</sup>/<sub>8</sub>"x8<sup>7</sup>/<sub>8</sub>"

AMKU Mek Blue Spigolo A.E.

0,8x0,8 cm - 3<sup>1</sup>/<sub>8</sub>"x2<sup>1</sup>/<sub>8</sub>"

## 3D TRIM TILES

LM1L Mek Light Spigolo 10mm \*

1x20 cm - 3<sup>1</sup>/<sub>8</sub>"x7<sup>7</sup>/<sub>8</sub>"

LM1M Mek Medium Spigolo 10mm \*

1x20 cm - 3<sup>1</sup>/<sub>8</sub>"x7<sup>7</sup>/<sub>8</sub>"

LM1R Mek Rose Spigolo 10mm \*

1x20 cm - 3<sup>1</sup>/<sub>8</sub>"x7<sup>7</sup>/<sub>8</sub>"

LM1U Mek Blue Spigolo 10mm \*

1x20 cm - 3<sup>1</sup>/<sub>8</sub>"x7<sup>7</sup>/<sub>8</sub>"

The 10 mm edge matches three-dimensional wall tiles having a 10-11 mm thickness -  
Lo spigolo 10 mm si abbina a rivestimenti tridimensionali di spessore 10-11 mm - Le bord  
10 mm s'adapte aux revêtements tridimensionnels épaisseur 10-11 mm - Die 10 mm Kante  
ist mit dreidimensionalen Wandfliesen mit einer Dicke von 10-11 mm kombinierbar -  
La arista de 10 mm se combina con revestimientos tridimensionales de 10 -11 mm  
de grosor - Угловой элемент 10 мм сочетается с трехмерной настенной плиткой  
толщиной 10-11 мм

\* These parts are supplied to order - I pezzi sono disponibili su ordinazione - Les pièces  
sont disponibles sur commande - Die Teile sind auf Bestellung lieferbar - Las piezas se  
hacen por encargo - Изготавливаются на заказ

Matte surface - Superficie matt - Surface Mat - Matte Oberfläche -  
Superficie Mate - Матовая поверхность



LIGHT



3D FOLD LIGHT



MEDIUM



3D FOLD MEDIUM



ROSE



3D ULTRA BLADE ROSE

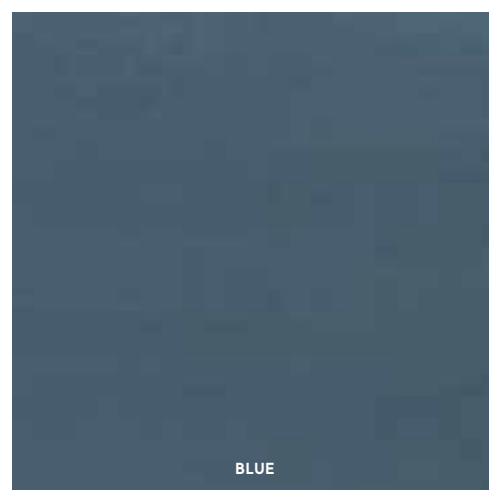

BLUE

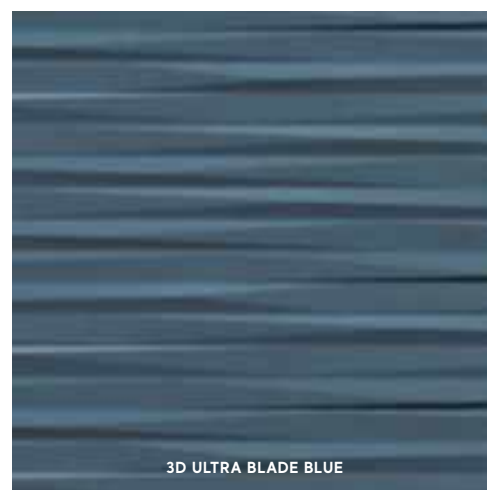

3D ULTRA BLADE BLUE

## DECOR RANGE



A4T9 Mek Rose Hexagon •  
50x120 - 19<sup>5</sup>/<sub>8</sub>"x47<sup>1</sup>/<sub>4</sub>"



A4UA Mek Rose Wallpaper  
50x120 - 19<sup>5</sup>/<sub>8</sub>"x47<sup>1</sup>/<sub>4</sub>"



A4UB Mek Blue Wallpaper  
50x120 - 19<sup>5</sup>/<sub>8</sub>"x47<sup>1</sup>/<sub>4</sub>"



4MKC Mek Gold Circles •  
29x31 - 11<sup>1</sup>/<sub>8</sub>"x12<sup>1</sup>/<sub>4</sub>"

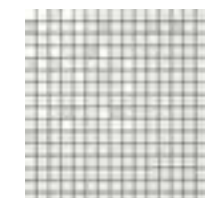

9MQL Mek Light  
Mosaico Q Wall  
30,5x30,5 - 12"x12"

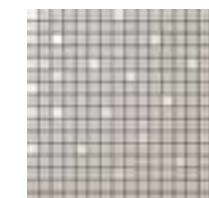

9MQM Mek Medium  
Mosaico Q Wall  
30,5x30,5 - 12"x12"



9MQR Mek Rose  
Mosaico Q Wall  
30,5x30,5 - 12"x12"



9MCU Mek Blue  
Mosaico Q Wall  
30,5x30,5 - 12"x12"

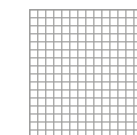

1,7x1,7 cm  
3<sup>1</sup>/<sub>8</sub>"x3<sup>1</sup>/<sub>8</sub>"



9MCH Mek Light  
Mosaico Chevron Wall  
30,5x30,5 - 12"x12"



9MCE Mek Medium  
Mosaico Chevron Wall  
30,5x30,5 - 12"x12"



9MCR Mek Rose  
Mosaico Chevron Wall  
30,5x30,5 - 12"x12"



9MCU Mek Blue  
Mosaico Chevron Wall  
30,5x30,5 - 12"x12"



A 5x3 cm - 2"x1<sup>1</sup>/<sub>8</sub>"  
B 5x1,7 cm - 2"x3<sup>1</sup>/<sub>8</sub>"  
C 5x5,5 cm - 2"x2<sup>1</sup>/<sub>8</sub>"



9MDL Mek Light  
Mosaico Diamond Wall  
30,5x30,5 - 12"x12"



9MDM Mek Medium  
Mosaico Diamond Wall  
30,5x30,5 - 12"x12"



9MDR Mek Rose  
Mosaico Diamond Wall  
30,5x30,5 - 12"x12"



9MDU Mek Blue •  
Mosaico Diamond Gold Wall  
30,5x30,5 - 12"x12"

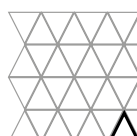

7,4x7,4 cm  
2<sup>7</sup>/<sub>8</sub>"x2<sup>7</sup>/<sub>8</sub>"

• Decor with gold insert - Decoro con inserto in oro - Décor avec insert en or - Dekor mit Goldinlage - Decoración con aplicación de oro - Декор с золотой вставкой

INDEX



PRODUCT  
FINDER



SURFACE  
RANGE



COMPANY



COLLECTIONS



- 3D WALL
- CONCRETE & RESIN LOOK
- METAL LOOK
- MARBLE LOOK
- STONE LOOK
- WOOD LOOK

LARGE SIZES



TECHNICAL  
SPECIFICATIONS



# Prism

A COLOR CONCEPT by Piero Lissoni

DOWNLOAD >  
CATALOG &  
IMAGE GALLERY

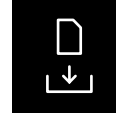

ENJOY THE  
VIDEO

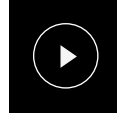

© Ceramiche Atlas Concorde



© Ceramiche Atlas Concorde



© Ceramiche Atlas Concorde

## Porcelain Tiles



### COLOURED BODY PORCELAIN TILES - RECTIFIED MONOCALIBER

Sizes	Thickness	Surface finish
120x278 cm - 47 <sup>1</sup> / <sub>4</sub> "x109 <sup>1</sup> / <sub>2</sub> "	± 6 mm	Matte R9 A
120x120 cm - 47 <sup>1</sup> / <sub>4</sub> "x47 <sup>1</sup> / <sub>4</sub> "	± 9 mm	Silk   Matte R10 A+B
60x120 cm - 23 <sup>3</sup> / <sub>8</sub> "x47 <sup>1</sup> / <sub>4</sub> "	± 9 mm	Matte R10 A+B
60x60 cm - 23 <sup>3</sup> / <sub>8</sub> "x23 <sup>3</sup> / <sub>8</sub> "	± 9 mm	Silk   Matte R10 A+B
30x60 cm - 11 <sup>3</sup> / <sub>4</sub> "x23 <sup>3</sup> / <sub>8</sub> "	± 9 mm	Silk   Matte R10 A+B

### OUTDOOR AND WET AREAS

Sizes	Thickness	Surface finish
120x120 cm - 47 <sup>1</sup> / <sub>4</sub> "x47 <sup>1</sup> / <sub>4</sub> "	± 9 mm	Grip R11 A+B+C
120x120 cm - 47 <sup>1</sup> / <sub>4</sub> "x47 <sup>1</sup> / <sub>4</sub> "	± 20 mm	Outdoor R11 A+B+C
80x80 cm - 31 <sup>1</sup> / <sub>2</sub> "x31 <sup>1</sup> / <sub>2</sub> "	± 20 mm	Outdoor R11 A+B+C

LARGE SIZES p. 390

### GLAZED PORCELAIN TILES

Sizes	Thickness	Surface finish
120x278 cm - 47 <sup>1</sup> / <sub>4</sub> "x109 <sup>1</sup> / <sub>2</sub> "	± 6 mm	Matte

## Wall Tiles



### WHITEBODY WALL TILES - RECTIFIED MONOCALIBER

Sizes	Thickness	Surface finish
50x120 cm - 19 <sup>3</sup> / <sub>8</sub> "x47 <sup>1</sup> / <sub>4</sub> "	± 8,5 mm	Matte

Coloured body porcelain tiles - Gres porcellanato colorato in massa - Grès cérame coloré dans la masse - Durchgefärbtes Feinsteinzeug - Gres porcelánico coloreado en masa - Керамический гранит окрашенный в массе  
 Glazed porcelain tiles - Gres Porcellanato Smaltato - Grès cérame émaillé - Glasiertes Feinsteinzeug - Gres porcelánico esmaltado - Глазурованный керамический гранит  
 Whitebody wall tiles - Rivestimenti in pasta bianca - Revêtements en pâte blanche - Weißscherbige Wandfliesen - Revestimientos en pasta blanca - Настенная плитка из белой глины  
 Rectified monocaliber - Rettificato monocalibro - Rectifié mono-calibre - Geschliffen einkalbrig - Rectificado monocalibre - Ретифицированный в одном калибре

INDEX



PRODUCT  
FINDER



SURFACE  
RANGE



COMPANY



COLLECTIONS



- 3D WALL
- CONCRETE & RESIN LOOK
- METAL LOOK
- MARBLE LOOK
- STONE LOOK
- WOOD LOOK

LARGE SIZES



TECHNICAL  
SPECIFICATIONS



# Prism

## Porcelain Tiles

### MATTE SURFACE



**± 6 mm**  
**120x278 cm** - 47<sup>1</sup>/<sub>4</sub>"x109<sup>1</sup>/<sub>2</sub>"  
 A4UP Prism Suede  
 A4UQ Prism Cord  
 A4UR Prism Cotton  
 A4US Prism Cloud  
 A4UT Prism Fog  
 A4UU Prism Graphite



**± 9 mm**  
**120x120 cm** - 47<sup>1</sup>/<sub>4</sub>"x47<sup>1</sup>/<sub>4</sub>"  
 A4OG Prism Suede  
 A4OH Prism Cord  
 A4OI Prism Cotton  
 A4OJ Prism Cloud  
 A4OK Prism Fog  
 A4OL Prism Graphite



**± 9 mm**  
**60x120 cm** - 23<sup>5</sup>/<sub>8</sub>"x47<sup>1</sup>/<sub>4</sub>"  
 A4OS Prism Suede  
 A4OT Prism Cord  
 A4OU Prism Cotton  
 A4OV Prism Cloud  
 A4OW Prism Fog  
 A4OX Prism Graphite



**± 9 mm**  
**60x60 cm** - 23<sup>5</sup>/<sub>8</sub>"x23<sup>5</sup>/<sub>8</sub>"  
 A4UV Prism Suede  
 A4UW Prism Cord  
 A4UX Prism Cotton  
 A4UY Prism Cloud  
 A4UZ Prism Fog  
 A4UØ Prism Graphite



**± 9 mm**  
**30x60 cm** - 11<sup>3</sup>/<sub>4</sub>"x23<sup>5</sup>/<sub>8</sub>"  
 A4U1 Prism Suede  
 A4U2 Prism Cord  
 A4U3 Prism Cotton  
 A4U4 Prism Cloud  
 A4U5 Prism Fog  
 A4U6 Prism Graphite



### SILK SURFACE

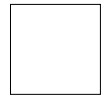

**± 9 mm**  
**120x120 cm** - 47<sup>1</sup>/<sub>4</sub>"x47<sup>1</sup>/<sub>4</sub>"  
 A4OM Prism Suede Silk  
 A4ON Prism Cord Silk  
 A4OO Prism Cotton Silk  
 A4OP Prism Cloud Silk  
 A4OQ Prism Fog Silk  
 A4OR Prism Graphite Silk



**± 9 mm**  
**60x60 cm** - 23<sup>5</sup>/<sub>8</sub>"x23<sup>5</sup>/<sub>8</sub>"  
 A5RV Prism Suede Silk  
 A5RW Prism Cord Silk  
 A5RX Prism Cotton Silk  
 A5RY Prism Cloud Silk  
 A5RZ Prism Fog Silk  
 A5RØ Prism Graphite Silk



**± 9 mm**  
**30x60 cm** - 11<sup>3</sup>/<sub>4</sub>"x23<sup>5</sup>/<sub>8</sub>"  
 A5R2 Prism Suede Silk  
 A5R6 Prism Cord Silk  
 A5R7 Prism Cotton Silk  
 A5SA Prism Cloud Silk  
 A5SB Prism Fog Silk  
 A5SC Prism Graphite Silk



### GRIP SURFACE

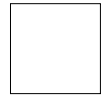

**± 9 mm**  
**120x120 cm** - 47<sup>1</sup>/<sub>4</sub>"x47<sup>1</sup>/<sub>4</sub>"  
 A5OI Prism Suede Grip  
 A5OJ Prism Cord Grip  
 A5OK Prism Cloud Grip  
 A5OL Prism Fog Grip



**± 20 mm**  
**120x120 cm** - 47<sup>1</sup>/<sub>4</sub>"x47<sup>1</sup>/<sub>4</sub>"  
 A5OM Prism Suede 20 mm  
 A5ON Prism Cord 20 mm  
 A5OO Prism Cloud 20 mm  
 A5OP Prism Fog 20 mm



**± 20 mm**  
**80x80 cm** - 31<sup>1</sup>/<sub>2</sub>"x31<sup>1</sup>/<sub>2</sub>"  
 A56H Prism Suede 20 mm  
 A56I Prism Cord 20 mm  
 A56J Prism Cloud 20 mm  
 A56K Prism Fog 20 mm



## Glazed Porcelain Tiles

### MATTE SURFACE



**± 6 mm**  
**120x278 cm** - 47<sup>1</sup>/<sub>4</sub>"x109<sup>1</sup>/<sub>2</sub>" ■  
 A4VH Prism Bloom  
 A4VI Prism Caramel  
 A4VJ Prism Grape  
 A4VK Prism Dusk  
 A4VL Prism Midnight  
 A4VM Prism Moss  
 A4VN Prism Emerald



■ **The use of a common mild detergent is recommended. Avoid using acidic or alkaline products, waxes, steel wool, or abrasives.** - Si consiglia l'utilizzo di un comune detergente neutro. Evitare l'utilizzo di prodotti acidi o alcalini, ceranti, pagliette di metallo o abrasive. - Nous vous conseillons d'utiliser des détergents neutres courants. Éviter l'utilisation de cires et de produits acides ou alcalins, ainsi que les pailles métalliques ou abrasives. - Es empfiehlt sich, ein haushaltsübliches, neutrales Reinigungsmittel zu verwenden. Saure oder alkalische Produkte, Wachs sowie Metallwolle- bzw. Scheuerschwämme sind zu vermeiden. - Recomendamos utilizar un detergente neutro común. Hay que evitar el uso de productos ácidos o alcalinos, ceras y estropajos de metal o abrasivos. - Рекомендуется чистить обычным нейтральным моющим средством. Не рекомендуется использовать кислотные, щелочные, восковые средства, а также металлические мочалки.

**Matte surface** - Superficie matt - Surface Mat - Matte Oberfläche - Superficie Mate - Матовая поверхность  
**Grip surface** - Superficie grip - Surface grip - Grip Oberfläche - Superficie Grip - Grip поверхность  
**Silk surface** - Superficie silk - Surface Silk - Silk Oberfläche - Superficie Silk - Поверхность Silk  
**Outdoor** - Pavimenti da esterno - Sols d'extérieur - Bodenbeläge für Außenbereiche - Pavimentos para exteriores - Уличная плитка



INDEX



PRODUCT  
FINDER



SURFACE  
RANGE



COMPANY



COLLECTIONS



- 3D WALL
- CONCRETE & RESIN LOOK
- METAL LOOK
- MARBLE LOOK
- STONE LOOK
- WOOD LOOK

LARGE SIZES



TECHNICAL  
SPECIFICATIONS



# Prism

## Porcelain Tiles

### DECOR RANGE

4.8x4.8 cm  
1 7/8" x 1 7/8"

**A** 44,6 cm - 17 1/2"  
**B** 31 cm - 12 1/4"  
**a** 35,7 cm - 14"  
**b** 7,6 cm - 3"  
**c** 8,8 cm - 3 1/2"  
**d** 17,6 cm - 6 7/8"

**A4V1 Prism Cotton**  
Mosaico Matt  
30x30 - 1 1/4" x 1 1/4"

**A4VØ Prism Cord**  
Mosaico Matt  
30x30 - 1 1/4" x 1 1/4"

**A4VZ Prism Suede**  
Mosaico Matt  
30x30 - 1 1/4" x 1 1/4"

**A4V2 Prism Cloud**  
Mosaico Matt  
30x30 - 1 1/4" x 1 1/4"

**A4V3 Prism Fog**  
Mosaico Matt  
30x30 - 1 1/4" x 1 1/4"

**A4V4 Prism Graphite**  
Mosaico Matt  
30x30 - 1 1/4" x 1 1/4"

**A41S Prism Cotton**  
Mosaico Maze  
31x35,7 - 12 1/4" x 14"

**A41R Prism Cord**  
Mosaico Maze  
31x35,7 - 12 1/4" x 14"

**A41Q Prism Suede**  
Mosaico Maze  
31x35,7 - 12 1/4" x 14"

**A41T Prism Cloud**  
Mosaico Maze  
31x35,7 - 12 1/4" x 14"

**A41U Prism Fog**  
Mosaico Maze  
31x35,7 - 12 1/4" x 14"

**A41V Prism Graphite**  
Mosaico Maze  
31x35,7 - 12 1/4" x 14"

**A41Y Prism Cotton**  
Mosaico Maze Silk  
31x35,7 - 12 1/4" x 14"

**A41X Prism Cord**  
Mosaico Maze Silk  
31x35,7 - 12 1/4" x 14"

**A41W Prism Suede**  
Mosaico Maze Silk  
31x35,7 - 12 1/4" x 14"

**A41Z Prism Cloud**  
Mosaico Maze Silk  
31x35,7 - 12 1/4" x 14"

**A411 Prism Fog**  
Mosaico Maze Silk  
31x35,7 - 12 1/4" x 14"

**A412 Prism Graphite**  
Mosaico Maze Silk  
31x35,7 - 12 1/4" x 14"

**A4VO Prism Gradient XL** ◆ ■  
120x278 cm - 47 1/4" x 109 1/2"

**A4VP Prism Brush XL** ◆ ■  
120x278 cm - 47 1/4" x 109 1/2"

◆ **The production process does not guarantee the presence of the exact sequence of the graphics inside the packaging** - Il processo produttivo non garantisce la presenza dell'esatta sequenza delle grafiche all'interno dell'imballaggio. - Le processus de fabrication ne garantit pas la présence de la séquence exacte des graphismes à l'intérieur de l'emballage. - Der Produktionsprozess garantiert nicht die exakte Sequenz der Grafiken in der Verpackung. - El proceso de producción no garantiza la presencia de la secuencia exacta de los gráficos dentro del embalaje. - Процесс производства не обеспечивает наличие точно совпадающих рисунков поверхности внутри упаковки.

■ **The use of a common mild detergent is recommended. Avoid using acidic or alkaline products, waxes, steel wool, or abrasives.** - Si consiglia l'utilizzo di un comune detergente neutro. Evitare l'utilizzo di prodotti acidi o alcalini, ceranti, pagliette di metallo o abrasive. - Nous vous conseillons d'utiliser des détergents neutres courants. Éviter l'utilisation de cires et de produits acides ou alcalins, ainsi que les pailles métalliques ou abrasives. - Es empfiehlt sich, ein haushaltsübliches, neutrales Reinigungsmittel zu verwenden. Saure oder alkalische Produkte, Wachs sowie Metallwolle- bzw. Scheuerschwämme sind zu vermeiden. - Recomendamos utilizar un detergente neutro común. Hay que evitar el uso de productos ácidos o alcalinos, ceras y estropajos de metal o abrasivos. - Рекомендуется использовать нейтральным моющим средством. Не рекомендуется использовать кислотные, щелочные, восковые средства, а также металлические моющие средства.

■ **The decoration can only be laid on the wall** - Il decoro si può posare solo a rivestimento - Décor uniquement mural - Das Dekor kann nur an der Wand verlegt werden - La decoración se puede colocar únicamente en paredes - Декор может быть уложен только на стену.

TRIM TILES		Battiscopa		Gradino *		Scalino *		Scalino *		Scalin Ang.*		Corner *	Corner A.E.*	Battiscopa Sag. Scala *				Elemento L *
p. 462		7,2x60 cm 2 7/8" x 23 3/8"		30x60 cm 1 1/4" x 23 3/8"		33x120 cm 13" x 47 1/4"		33x60 cm 13" x 23 3/8"		33x33 cm 13" x 13"		1x120 cm 3/8" x 47 1/4"	1x1 cm 3/8" x 3/8"	7,2x30 cm 2 7/8" x 11 1/4"				33x120 H.4 cm 13" x 47 1/4" H.1 1/2"
p. 455		Matt	Silk	Matt	Silk	Matt	Silk	Matt	Silk	Matt	Silk	Matt	Matt	SX	DX	SX	DX	Grip
Cotton	A4XØ	A5SH	A4YI	A5SX	A4YU	A4Y6	A4YO	A5S3	A4YØ	A4ZD	A4ZJ	A4ZP	A4YC	A4X6	A5SR	A5SL	-	
Cord	A4XZ	A5SE	A4YH	A5SW	A4YT	A4Y5	A4YN	A5S2	A4YZ	A4ZC	A4ZI	A4ZO	A4YB	A4X5	A5SQ	A5SK	A5OZ	
Suede	A4XY	A5SD	A4YG	A5SV	A4YS	A4Y4	A4YM	A5S1	A4YY	A4ZB	A4ZH	A4ZN	A4YA	A4X4	A5SP	A5SJ	A5OY	
Cloud	A4X1	A5SF	A4YJ	A5SY	A4YV	A4Y7	A4YP	A5S4	A4Y1	A4ZE	A4ZK	A4ZQ	A4YD	A4X7	A5SS	A5SM	A5OØ	
Fog	A4X2	A5SG	A4YK	A5SZ	A4YW	A4Y9	A4YQ	A5S5	A4Y2	A4ZF	A4ZL	A4ZR	A4YE	A4X8	A5ST	A5SN	A5O1	
Graphite	A4X3	A5SI	A4YL	A5SØ	A4YX	A4ZA	A4YR	A5S6	A4Y3	A4ZG	A4ZM	A4ZS	A4YF	A4X9	A5SU	A5SO	-	

\* These parts are supplied to order - I pezzi sono disponibili su ordinazione - Les pièces sont disponibles sur commande - Die Teile sind auf Bestellung lieferbar - Las piezas se hacen por encargo - Изготавливаются на заказ

INDEX ☰

PRODUCT FINDER ➤

SURFACE RANGE ➤

COMPANY ➤

COLLECTIONS ➤

- 3D WALL
- CONCRETE & RESIN LOOK
- METAL LOOK
- MARBLE LOOK
- STONE LOOK
- WOOD LOOK

LARGE SIZES ➤

TECHNICAL SPECIFICATIONS ➤

# Prism Wall Tiles

## MATTE SURFACE



V2 Slight Variation



± 8,5 mm

50x120 cm - 19<sup>5</sup>/<sub>8</sub>" x 47<sup>1</sup>/<sub>4</sub>"

- A4TF Prism Suede
- A4TG Prism Cord
- A4TH Prism Cotton
- A4TI Prism Cloud
- A4TJ Prism Graphite
- A4TK Prism Bloom
- A4TL Prism Caramel
- A4TM Prism Grape
- A4TN Prism Dusk
- A4TO Prism Midnight
- A4TP Prism Moss
- A4TQ Prism Emerald

## TRIM TILES



1,4x50 cm - 5<sup>1</sup>/<sub>8</sub>" x 19<sup>5</sup>/<sub>8</sub>"

- A4ØO Prism Suede Corner 50 \*
- A4ØP Prism Cord Corner 50 \*
- A4ØQ Prism Cotton Corner 50 \*
- A4ØR Prism Cloud Corner 50 \*
- A4ØS Prism Graphite Corner 50 \*
- A4ØT Prism Bloom Corner 50 \*
- A4ØU Prism Caramel Corner 50 \*
- A4ØV Prism Grape Corner 50 \*
- A4ØW Prism Dusk Corner 50 \*
- A4ØX Prism Midnight Corner 50 \*
- A4ØY Prism Moss Corner 50 \*
- A4ØZ Prism Emerald Corner 50 \*



1,4x1,4 cm - 5<sup>1</sup>/<sub>8</sub>" x 5<sup>1</sup>/<sub>8</sub>"

- A4Ø1 Prism Suede Corner A.E. \*
- A4Ø2 Prism Cord Corner A.E. \*
- A4Ø3 Prism Cotton Corner A.E. \*
- A4Ø4 Prism Cloud Corner A.E. \*
- A4Ø5 Prism Graphite Corner A.E. \*
- A4Ø6 Prism Bloom Corner A.E. \*
- A4Ø7 Prism Caramel Corner A.E. \*
- A4Ø8 Prism Grape Corner A.E. \*
- A4Ø9 Prism Dusk Corner A.E. \*
- A41A Prism Midnight Corner A.E. \*
- A41B Prism Moss Corner A.E. \*
- A41C Prism Emerald Corner A.E. \*

\* These parts are supplied to order - I pezzi sono disponibili su ordinazione - Les pièces sont disponibles sur commande - Die Teile sind auf Bestellung lieferbar - Las piezas se hacen por encargo - Изготавливаются на заказ

Matte surface - Superficie matt - Surface Mat - Matte Oberfläche - Superficie Mate - Матовая поверхность



© Ceramiche Atlas Concorde



© Ceramiche Atlas Concorde



© Ceramiche Atlas Concorde

INDEX



PRODUCT  
FINDER



SURFACE  
RANGE



COMPANY



COLLECTIONS



3D WALL

CONCRETE & RESIN LOOK

METAL LOOK

MARBLE LOOK

STONE LOOK

WOOD LOOK

LARGE SIZES



TECHNICAL  
SPECIFICATIONS



# Prism Wall Tiles

## DECOR RANGE



A4TS Prism Brush ▲  
50x120 cm - 19<sup>3</sup>/<sub>8</sub>"x47<sup>1</sup>/<sub>4</sub>"

8 patterns



A4ZT Prism Enigma  
50x120 cm - 19<sup>3</sup>/<sub>8</sub>"x47<sup>1</sup>/<sub>4</sub>"

This item matches with the following colors / Questo articolo si abbina ai colori seguenti:  
Cloud 50x120, Graphite 50x120, Cotton 50x120



A4TR Prism Gradient ▲  
50x120 cm - 19<sup>3</sup>/<sub>8</sub>"x47<sup>1</sup>/<sub>4</sub>"

12 patterns



A4ZU Prism Gold ●  
50x120 cm - 19<sup>3</sup>/<sub>8</sub>"x47<sup>1</sup>/<sub>4</sub>"

This item matches with the following colors / Questo articolo si abbina ai colori seguenti:  
Bloom 50x120, Caramel 50x120, Grape 50x120, Cord 50x120, Cloud 50x120, Suede 50x120, Cotton 50x120

● Contains gold. The use of a common mild detergent is recommended. Avoid using acidic or alkaline products, waxes, steel wool, or abrasives. - Parti in oro. Si consiglia l'utilizzo di un comune detergente neutro. Evitare l'utilizzo di prodotti acidi o alcalini, ceranti, pagliette di metallo o abrasive. - Parties dorées. Nous vous conseillons d'utiliser des détergents neutres courants. Éviter l'utilisation de cires et de produits acides ou alcalins, ainsi que les pailles métalliques ou abrasives. - Teile aus Gold. Es empfiehlt sich, ein haushaltsübliches, neutrales Reinigungsmittel zu verwenden. Saure oder alkalische Produkte, Wachs sowie Metallwolle- bzw. Scheuerschwämme sind zu vermeiden. - Partes doradas. Recomendamos utilizar un detergente neutro común. Hay que evitar el uso de productos ácidos o alcalinos, ceras y estropajos de metal o abrasivos. - Золотые детали. Рекомендуется чистить обычным нейтральным моющим средством. Не рекомендуется использовать кислотные, щелочные, восковые средства, а также металлические мочалки.

▲ Item sold by square meter. - Articolo venduto al mq. - Article vendu au mètre carré. - Artikel pro m<sup>2</sup> verkauft. - Artículo vendido por m<sup>2</sup>. - Артикул продается квадратными метрами.

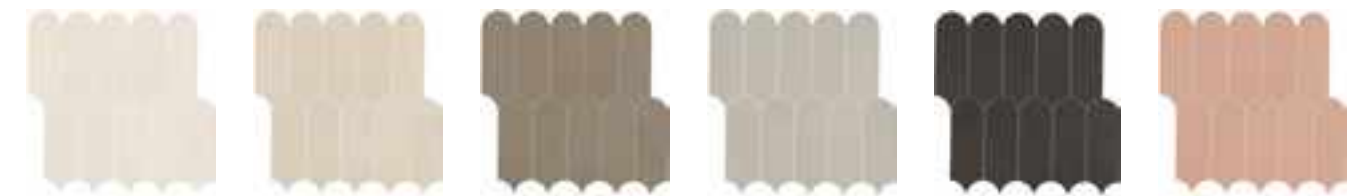

A4ZX Prism Cotton  
Mosaico Bead  
29,7x29,6 - 11<sup>5</sup>/<sub>8</sub>"x11<sup>5</sup>/<sub>8</sub>"

A4ZW Prism Cord  
Mosaico Bead  
29,7x29,6 - 11<sup>5</sup>/<sub>8</sub>"x11<sup>5</sup>/<sub>8</sub>"

A4ZV Prism Suede  
Mosaico Bead  
29,7x29,6 - 11<sup>5</sup>/<sub>8</sub>"x11<sup>5</sup>/<sub>8</sub>"

A4ZY Prism Cloud  
Mosaico Bead  
29,7x29,6 - 11<sup>5</sup>/<sub>8</sub>"x11<sup>5</sup>/<sub>8</sub>"

A4ZZ Prism Graphite  
Mosaico Bead  
29,7x29,6 - 11<sup>5</sup>/<sub>8</sub>"x11<sup>5</sup>/<sub>8</sub>"

A4ZØ Prism Bloom  
Mosaico Bead  
29,7x29,6 - 11<sup>5</sup>/<sub>8</sub>"x11<sup>5</sup>/<sub>8</sub>"

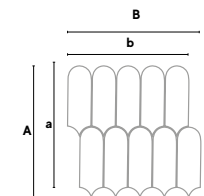

A 32 cm - 12<sup>5</sup>/<sub>8</sub>"  
a 29,6 cm - 11<sup>5</sup>/<sub>8</sub>"  
B 32,6 cm - 12<sup>7</sup>/<sub>8</sub>"  
b 29,7 cm - 11<sup>5</sup>/<sub>4</sub>"

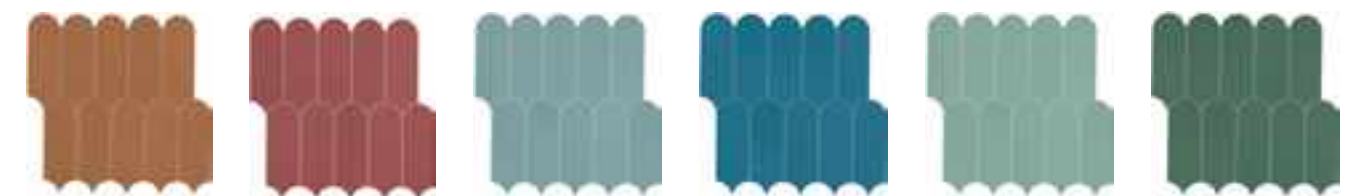

A4Z1 Prism Caramel  
Mosaico Bead  
29,7x29,6 - 11<sup>5</sup>/<sub>8</sub>"x11<sup>5</sup>/<sub>8</sub>"

A4Z2 Prism Grape  
Mosaico Bead  
29,7x29,6 - 11<sup>5</sup>/<sub>8</sub>"x11<sup>5</sup>/<sub>8</sub>"

A4Z3 Prism Dusk  
Mosaico Bead  
29,7x29,6 - 11<sup>5</sup>/<sub>8</sub>"x11<sup>5</sup>/<sub>8</sub>"

A4Z4 Prism Midnight  
Mosaico Bead  
29,7x29,6 - 11<sup>5</sup>/<sub>8</sub>"x11<sup>5</sup>/<sub>8</sub>"

A4Z5 Prism Moss  
Mosaico Bead  
29,7x29,6 - 11<sup>5</sup>/<sub>8</sub>"x11<sup>5</sup>/<sub>8</sub>"

A4Z6 Prism Emerald  
Mosaico Bead  
29,7x29,6 - 11<sup>5</sup>/<sub>8</sub>"x11<sup>5</sup>/<sub>8</sub>"

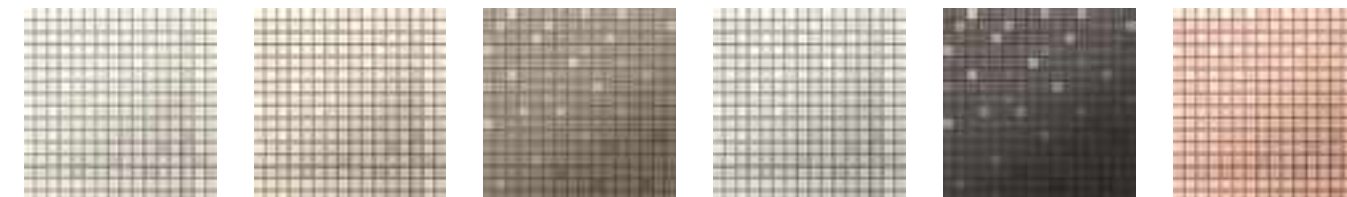

A4ØE Prism Cotton  
Mosaic Q  
30,5x30,5 - 12"x12"

A4ØD Prism Cord  
Mosaic Q  
30,5x30,5 - 12"x12"

A4ØC Prism Suede  
Mosaic Q  
30,5x30,5 - 12"x12"

A4ØF Prism Cloud  
Mosaic Q  
30,5x30,5 - 12"x12"

A4ØG Prism Graphite  
Mosaic Q  
30,5x30,5 - 12"x12"

A4ØH Prism Bloom  
Mosaic Q  
30,5x30,5 - 12"x12"

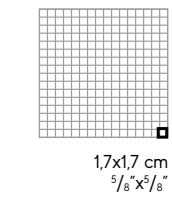

1,7x1,7 cm  
5/8" x 5/8"

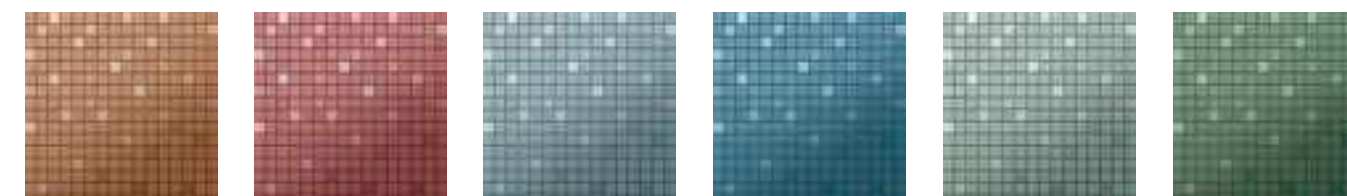

A4ØI Prism Caramel  
Mosaic Q  
30,5x30,5 - 12"x12"

A4ØJ Prism Grape  
Mosaic Q  
30,5x30,5 - 12"x12"

A4ØK Prism Dusk  
Mosaic Q  
30,5x30,5 - 12"x12"

A4ØL Prism Midnight  
Mosaic Q  
30,5x30,5 - 12"x12"

A4ØM Prism Moss  
Mosaic Q  
30,5x30,5 - 12"x12"

A4ØN Prism Emerald  
Mosaic Q  
30,5x30,5 - 12"x12"



A4Z7 Prism Cotton  
Wiggle  
30,6x32,4 - 12"x12<sup>3</sup>/<sub>4</sub>"

A4Z8 Prism Bloom  
Wiggle  
30,6x32,4 - 12"x12<sup>3</sup>/<sub>4</sub>"

A4Z9 Prism Dusk  
Wiggle  
30,6x32,4 - 12"x12<sup>3</sup>/<sub>4</sub>"

A4ØB Prism Moss  
Wiggle  
30,6x32,4 - 12"x12<sup>3</sup>/<sub>4</sub>"

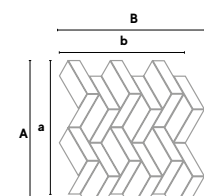

A 36,1 cm - 14<sup>1</sup>/<sub>4</sub>"  
a 32,3 cm - 12<sup>3</sup>/<sub>4</sub>"  
B 35,2 cm - 13<sup>7</sup>/<sub>8</sub>"  
b 30,6 cm - 12"

INDEX



PRODUCT  
FINDER



SURFACE  
RANGE



COMPANY



COLLECTIONS



3D WALL

CONCRETE & RESIN LOOK

METAL LOOK

MARBLE LOOK

STONE LOOK

WOOD LOOK

LARGE SIZES



TECHNICAL  
SPECIFICATIONS



# Raw

DOWNLOAD >  
CATALOG &  
IMAGE GALLERY

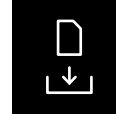

ENJOY THE  
VIDEO

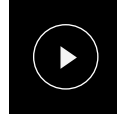

© Ceramiche Atlas Concorde



© Ceramiche Atlas Concorde



© Ceramiche Atlas Concorde

## Porcelain Tiles



### COLOURED BODY PORCELAIN TILES - RECTIFIED MONOCALIBER

Sizes	Thickness	Surface finish
120x278 cm - 47 <sup>1</sup> / <sub>4</sub> "x109 <sup>1</sup> / <sub>2</sub> "	± 6 mm	Matte <b>R9 A</b>
120x120 cm - 47 <sup>1</sup> / <sub>4</sub> "x47 <sup>1</sup> / <sub>4</sub> "	± 9 mm	Matte <b>R10 A+B</b>
75x150 cm - 29 <sup>1</sup> / <sub>2</sub> "x59"	± 9 mm	Matte <b>R10 A+B</b>
75x75 cm - 29 <sup>1</sup> / <sub>2</sub> "x29 <sup>1</sup> / <sub>2</sub> "	± 9 mm	Matte <b>R10 A+B</b>
37,5x75 cm - 14 <sup>3</sup> / <sub>4</sub> "x29 <sup>1</sup> / <sub>2</sub> "	± 9 mm	Matte <b>R10 A+B</b>
60x60 cm - 23 <sup>5</sup> / <sub>8</sub> "x23 <sup>5</sup> / <sub>8</sub> "	± 9 mm	Matte <b>R10 A+B</b>
30x60 cm - 11 <sup>3</sup> / <sub>4</sub> "x23 <sup>5</sup> / <sub>8</sub> "	± 9 mm	Matte <b>R10 A+B</b>

LARGE SIZES p. 390

### OUTDOOR AND WET AREAS

Sizes	Thickness	Surface finish
37,5x75 cm - 14 <sup>3</sup> / <sub>4</sub> "x29 <sup>1</sup> / <sub>2</sub> "	± 9 mm	Grip <b>R11 A+B+C</b>
120x120 cm - 47 <sup>1</sup> / <sub>4</sub> "x47 <sup>1</sup> / <sub>4</sub> "	± 20 mm	Outdoor <b>R11 A+B+C</b>
60x120 cm - 23 <sup>5</sup> / <sub>8</sub> "x47 <sup>1</sup> / <sub>4</sub> "	± 20 mm	Outdoor <b>R11 A+B+C</b>

## Wall Tiles



### WHITEBODY WALL TILES - RECTIFIED MONOCALIBER

Sizes	Thickness	Surface finish
50x120 cm - 19 <sup>5</sup> / <sub>8</sub> "x47 <sup>1</sup> / <sub>4</sub> "	± 8,5 mm	Matte
<b>3D WALL TILES</b>		
50x120 cm - 19 <sup>5</sup> / <sub>8</sub> "x47 <sup>1</sup> / <sub>4</sub> "	± 10 mm	Matte

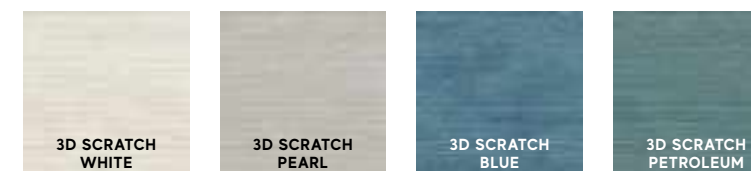

Coloured body porcelain tiles – Gres porcellanato colorato in massa – Grès cérame coloré dans la masse – Durchgefärbtes Feinsteinzeug – Gres porcelánico coloreado en masa – Керамический гранит окрашенный в массе  
 Whitebody wall tiles – Rivestimenti in pasta bianca – Revêtements en pâte blanche – Weißscherbige Wandfliesen – Revestimientos en pasta blanca – Настенная плитка из белой глины  
 Rectified monocaliber – Rettificato monocalibro – Rectifié mono-calibre – Geschliffen einkalbrig – Rectificado monocalibre – Ретифицированный в одном калибре

INDEX



PRODUCT  
FINDER



SURFACE  
RANGE



COMPANY



COLLECTIONS



- 3D WALL
- CONCRETE & RESIN LOOK
- METAL LOOK
- MARBLE LOOK
- STONE LOOK
- WOOD LOOK

LARGE SIZES



TECHNICAL  
SPECIFICATIONS





# Raw

## Porcelain Tiles



Matte ± 6 mm



Matte ± 9 mm  
Grip ± 9 mm  
Outdoor ± 20 mm



R9 A Matte ± 6 mm  
R10 A+B Matte ± 9 mm  
R11 A+B+C Grip ± 9 mm  
R11 A+B+C Outdoor ± 20 mm



V3 Moderate Variation

### MATTE SURFACE



**± 6 mm**  
**120x278 cm** - 47<sup>1</sup>/<sub>4</sub>"x109<sup>1</sup>/<sub>2</sub>"  
APMW Raw White  
APMX Raw Pearl  
APMY Raw Sand  
APMZ Raw Mud

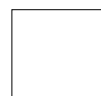

**± 9 mm**  
**120x120 cm** - 47<sup>1</sup>/<sub>4</sub>"x47<sup>1</sup>/<sub>4</sub>"  
APMK Raw White  
APML Raw Pearl  
APMU Raw Sand  
APMV Raw Mud



**± 9 mm**  
**60x60 cm** - 23<sup>5</sup>/<sub>8</sub>"x23<sup>5</sup>/<sub>8</sub>"  
APMB Raw White  
APMD Raw Pearl  
APME Raw Sand  
APMF Raw Mud



**± 9 mm**  
**30x60 cm** - 11<sup>3</sup>/<sub>4</sub>"x23<sup>5</sup>/<sub>8</sub>"  
APMG Raw White  
APMH Raw Pearl  
APMI Raw Sand  
APMJ Raw Mud



**± 9 mm**  
**75x150 cm** - 29<sup>1</sup>/<sub>2</sub>"x59"  
A7IE Raw White  
A7IF Raw Pearl  
A7IG Raw Sand  
A7IH Raw Mud



**± 9 mm**  
**75x75 cm** - 29<sup>1</sup>/<sub>2</sub>"x29<sup>1</sup>/<sub>2</sub>"  
APLW Raw White  
APLX Raw Pearl  
APLY Raw Sand  
APLZ Raw Mud



**± 9 mm**  
**37,5x75 cm** - 14<sup>3</sup>/<sub>4</sub>"x29<sup>1</sup>/<sub>2</sub>"  
APLØ Raw White  
APL1 Raw Pearl  
APL2 Raw Sand  
APL5 Raw Mud

### GRIP SURFACE



**± 9 mm**  
**37,5x75 cm** - 14<sup>3</sup>/<sub>4</sub>"x29<sup>1</sup>/<sub>2</sub>"  
APL7 Raw White  
APL8 Raw Pearl  
APL9 Raw Sand  
APMA Raw Mud



### OUTDOOR ± 20 mm



**± 20 mm**  
**120x120 cm** - 47<sup>1</sup>/<sub>4</sub>"x47<sup>1</sup>/<sub>4</sub>"  
AØ6K Raw White 20 mm  
AØ6M Raw Pearl 20 mm  
AØ6O Raw Sand 20 mm  
AØ6P Raw Mud 20 mm

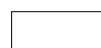

**± 20 mm**  
**60x120 cm** - 23<sup>5</sup>/<sub>8</sub>"x47<sup>1</sup>/<sub>4</sub>"  
AØJO Raw White 20 mm  
AØJP Raw Pearl 20 mm  
AØJQ Raw Sand 20 mm  
AØJR Raw Mud 20 mm



WHITE



PEARL



SAND

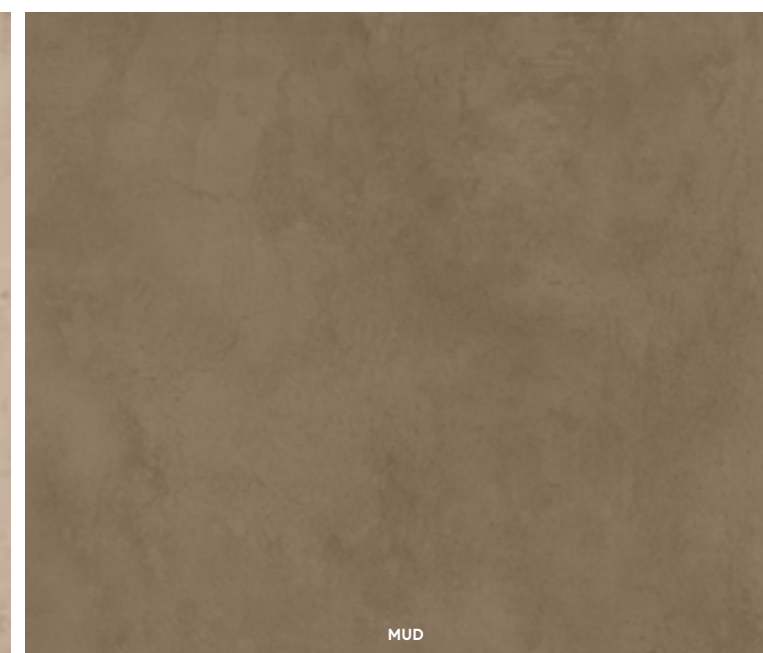

MUD

**Matte surface** – Superficie matt – Surface Mat – Matte Oberfläche – Superficie Mate – Матовая поверхность  
**Grip surface** – Superficie grip – Surface grip – Grip Oberfläche – Superficie Grip – Grip поверхность  
**Outdoor** – Pavimenti da esterno – Sols d'extérieur – Bodenbeläge für Außenbereiche – Pavimentos para exteriores – Уличная плитка

INDEX



PRODUCT  
FINDER



SURFACE  
RANGE



COMPANY



COLLECTIONS



- 3D WALL
- CONCRETE & RESIN LOOK
- METAL LOOK
- MARBLE LOOK
- STONE LOOK
- WOOD LOOK

LARGE SIZES



TECHNICAL  
SPECIFICATIONS



# Raw

## Porcelain Tiles

### DECOR RANGE

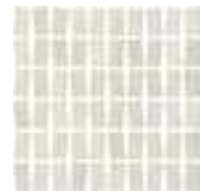

A00J Raw White  
Mosaico Castle ▲  
29x29,2 - 11<sup>1</sup>/<sub>8</sub>"x11<sup>1</sup>/<sub>8</sub>"

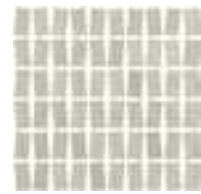

A00K Raw Pearl  
Mosaico Castle ▲  
29x29,2 - 11<sup>1</sup>/<sub>8</sub>"x11<sup>1</sup>/<sub>8</sub>"

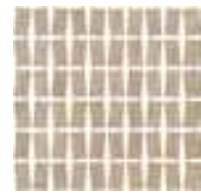

A00L Raw Sand  
Mosaico Castle ▲  
29x29,2 - 11<sup>1</sup>/<sub>8</sub>"x11<sup>1</sup>/<sub>8</sub>"

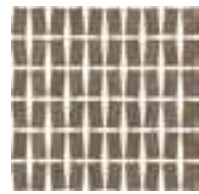

A00M Raw Mud  
Mosaico Castle ▲  
29x29,2 - 11<sup>1</sup>/<sub>8</sub>"x11<sup>1</sup>/<sub>8</sub>"

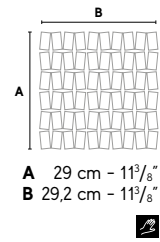

A00Z9 Raw White  
Mosaico Esagono  
35,2x30,5 - 13<sup>7</sup>/<sub>8</sub>"x12"



A00C Raw Pearl  
Mosaico Esagono  
35,2x30,5 - 13<sup>7</sup>/<sub>8</sub>"x12"



A00D Raw Sand  
Mosaico Esagono  
35,2x30,5 - 13<sup>7</sup>/<sub>8</sub>"x12"



A00E Raw Mud  
Mosaico Esagono  
35,2x30,5 - 13<sup>7</sup>/<sub>8</sub>"x12"

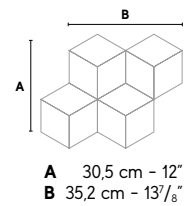

A00Z0 Raw White  
Mosaico Matt  
30x30 - 11<sup>3</sup>/<sub>8</sub>"x11<sup>3</sup>/<sub>8</sub>"

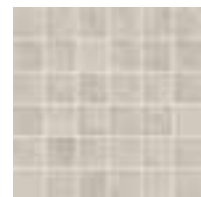

A00Z6 Raw Pearl  
Mosaico Matt  
30x30 - 11<sup>3</sup>/<sub>8</sub>"x11<sup>3</sup>/<sub>8</sub>"



A00Z7 Raw Sand  
Mosaico Matt  
30x30 - 11<sup>3</sup>/<sub>8</sub>"x11<sup>3</sup>/<sub>8</sub>"



A00Z8 Raw Mud  
Mosaico Matt  
30x30 - 11<sup>3</sup>/<sub>8</sub>"x11<sup>3</sup>/<sub>8</sub>"

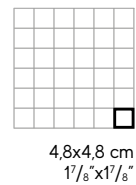

© Ceramiche Atlas Concorde

### TRIM TILES

p. 462



p. 455



	Battiscopa		Gradino *		Scalino *			Scalin Ang. *		Corner *	Corner A.E. *	Battiscopa Sag. Scala *		Elemento L
	7,2x150 cm 2 <sup>7</sup> / <sub>8</sub> "x59"	7,2x60 cm 2 <sup>7</sup> / <sub>8</sub> "x23 <sup>7</sup> / <sub>8</sub> "	37,5x75 cm 14 <sup>7</sup> / <sub>8</sub> "x29 <sup>1</sup> / <sub>2</sub> "	30x60 cm 11 <sup>3</sup> / <sub>8</sub> "x23 <sup>7</sup> / <sub>8</sub> "	37,5x150 cm 14 <sup>7</sup> / <sub>8</sub> "x59"	33x120 cm 13"x47 <sup>1</sup> / <sub>4</sub> "	33x60 cm 13"x23 <sup>7</sup> / <sub>8</sub> "	37,5x37,5 cm 14 <sup>7</sup> / <sub>8</sub> "x14 <sup>7</sup> / <sub>8</sub> "	33x33 cm 13"x13"	1x120 cm 3 <sup>7</sup> / <sub>8</sub> "x47 <sup>1</sup> / <sub>4</sub> "	1x1 cm 3 <sup>7</sup> / <sub>8</sub> "x3 <sup>7</sup> / <sub>8</sub> "	7,2x30 cm 2 <sup>7</sup> / <sub>8</sub> "x11 <sup>3</sup> / <sub>8</sub> "		15x75 H. 4 cm 5 <sup>7</sup> / <sub>8</sub> "x29 <sup>1</sup> / <sub>2</sub> "
	Matt	Matt	Matt	Matt	Matt	Matt	Matt	Matt	Matt	Matt	Matt	Matt DX	Matt SX	Grip
White	A2AD	A199	A2AT	A2AP	A2A8	A2A4	A2AX	A2BG	A2BC	A191	A195	A2AL	A2AH	A2BK
Pearl	A2AE	A2AA	A2AU	A2AQ	A2A9	A2A5	A2AY	A2BH	A2BD	A192	A196	A2AM	A2AI	A2BL
Sand	A2AF	A2AB	A2AV	A2AR	A2BA	A2A6	A2AZ	A2BI	A2BE	A193	A197	A2AN	A2AJ	A2BM
Mud	A2AG	A2AC	A2AW	A2AS	A2BB	A2A7	A2A3	A2BJ	A2BF	A194	A198	A2AO	A2AK	A2BN

\* These parts are supplied to order - I pezzini sono disponibili su ordinazione - Les pièces sont disponibles sur commande - Die Teile sind auf Bestellung lieferbar - Las piezas se hacen por encargo - Изготавливаются на заказ

▲ These mosaics allow you to customize a wall by choosing the color of the grout during the laying phase. The colors presented in these pages are mood suggestions and purely indicative. - Questi mosaici permettono di personalizzare la parete attraverso la scelta del colore dello stucco durante la fase di posa. I colori presentati in queste pagine sono suggerimenti di mood e sono puramente indicativi. - Ces mosaïques permettent de personnaliser le mur moyennant le choix du coloris du joint pendant la phase de pose. Les coloris présentés sur ces pages sont des idées de mood fournies qu'à titre purement indicatif. - Diese Mosaik können zur Personalisierung der Wand mit Fugenmassen in Farben nach Wahl verfügt werden. Die auf diesen Seiten abgebildeten Farben verstehen sich als unverbindliche Beispiele für den erzielbaren Gesamteindruck. - Con estos mosaicos es posible llevar a cabo cualquier idea de personalización de la pared, con la elección del color del estuco durante la fase de colocación. Los colores que les presentamos en estas páginas son sugerencias de estados de ánimo ("mood") y puramente indicativos. - Эта мозаика позволяет индивидуализировать стену путем выбора цвета шовной затирки. Цвета, представленные на этих страницах, приведены в качестве примеров и носят ориентировочный характер.

▲ The decoration can only be laid on the wall - Il decoro si può posare solo a rivestimento - Décor uniquement mural - Das Dekor kann nur an der Wand verlegt werden - La decoración se puede colocar únicamente en paredes - Декор может быть уложен только на стену.



© Ceramiche Atlas Concorde



© Ceramiche Atlas Concorde

INDEX



PRODUCT  
FINDER



SURFACE  
RANGE



COMPANY



COLLECTIONS



3D WALL

CONCRETE & RESIN LOOK

METAL LOOK

MARBLE LOOK

STONE LOOK

WOOD LOOK

LARGE SIZES



TECHNICAL  
SPECIFICATIONS



# Raw Wall Tiles

## MATTE SURFACE

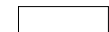

± 8,5 mm

50x120 cm - 19<sup>5</sup>/<sub>8</sub>"x47<sup>1</sup>/<sub>4</sub>"

- A4S2 Raw White
- A4SZ Raw Pearl
- A4S1 Raw Sand
- A4SX Raw Blue
- A4SØ Raw Rose
- A4SY Raw Petroleum

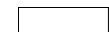

± 10 mm 3D WALL

50x120 cm - 19<sup>5</sup>/<sub>8</sub>"x47<sup>1</sup>/<sub>4</sub>"

- A4TE Raw 3D Scratch White
- A4TD Raw 3D Scratch Pearl
- A4TB Raw 3D Scratch Blue
- A4TC Raw 3D Scratch Petroleum



## TRIM TILES



1,4x50 cm - 5<sup>5</sup>/<sub>8</sub>"x19<sup>5</sup>/<sub>8</sub>"

- LR1W Raw White Corner 50 \*
- LR1P Raw Pearl Corner 50 \*
- LR1S Raw Sand Corner 50 \*
- LR1B Raw Blue Corner 50 \*
- LR1R Raw Rose Corner 50 \*
- LR1E Raw Petroleum Corner 50 \*
- LR3W Raw 3D Scratch White Corner 50 \*
- LR3A Raw 3D Scratch Pearl Corner 50 \*
- LR3L Raw 3D Scratch Blue Corner 50 \*
- LR3E Raw 3D Scratch Petroleum Corner 50 \*



1,4x1,4 cm - 5<sup>5</sup>/<sub>8</sub>"x5<sup>5</sup>/<sub>8</sub>"

- AØRW Raw White Corner A.E. 1,4 \*
- AØRP Raw Pearl Corner A.E. 1,4 \*
- AØRS Raw Sand Corner A.E. 1,4 \*
- AØRB Raw Blue Corner A.E. 1,4 \*
- AØRR Raw Rose Corner A.E. 1,4 \*
- AØRC Raw Petroleum Corner A.E. 1,4 \*

\* These parts are supplied to order - I pezzi sono disponibili su ordinazione - Les pièces sont disponibles sur commande - Die Teile sind auf Bestellung lieferbar - Las piezas se hacen por encargo - Изготавливаются на заказ  
Matte surface - Superficie matt - Surface Mat - Matte Oberfläche - Superficie Mate - Матовая поверхность

## DECOR RANGE



A4UG Raw Pearl Gold •  
50x120 cm - 19<sup>5</sup>/<sub>8</sub>"x47<sup>1</sup>/<sub>4</sub>"



A4UH Raw Sand Gold •  
50x120 cm - 19<sup>5</sup>/<sub>8</sub>"x47<sup>1</sup>/<sub>4</sub>"



A4UF Raw Blue Gold •  
50x120 cm - 19<sup>5</sup>/<sub>8</sub>"x47<sup>1</sup>/<sub>4</sub>"



9RBW Raw White ♦  
Mosaico Block  
28x28 - 11"x11"



9RBP Raw Pearl ♦  
Mosaico Block  
28x28 - 11"x11"



9RBS Raw Sand ♦  
Mosaico Block  
28x28 - 11"x11"



9RBB Raw Blue ♦  
Mosaico Block  
28x28 - 11"x11"



9RBO Raw Rose ♦  
Mosaico Block  
28x28 - 11"x11"

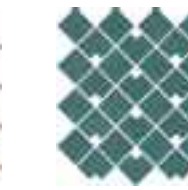

9RBE Raw Petroleum ♦  
Mosaico Block  
28x28 - 11"x11"

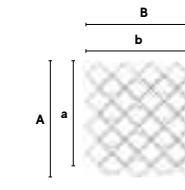

A 31,5 cm - 12<sup>3</sup>/<sub>8</sub>"  
a 28 cm - 11"  
B 31,5 cm - 12<sup>3</sup>/<sub>8</sub>"  
b 28 cm - 11"

• Contains gold. The use of a common mild detergent is recommended. Avoid using acidic or alkaline products, waxes, steel wool, or abrasives - Parti in oro. Si consiglia l'utilizzo di un comune detergente neutro. Evitare l'utilizzo di prodotti acidi o alcalini, ceranti, pagliette di metallo o abrasive - Parties dorées. Nous vous conseillons d'utiliser des détergents neutres courants. Éviter l'utilisation de cires et de produits acides ou alcalins, ainsi que les pailles métalliques ou abrasives - Teile aus Gold. Es empfiehlt sich, ein haushaltsübliches, neutrales Reinigungsmittel zu verwenden. Saure oder alkalische Produkte, Wachs sowie Metallwolle- bzw. Scheuerschwämme sind zu vermeiden - Partes doradas. Recomendamos utilizar un detergente neutro común. Hay que evitar el uso de productos ácidos o alcalinos, ceras y estropajos de metal o abrasivos - Золотые детали. Рекомендуется чистить обычным нейтральным моющим средством. Не рекомендуется использовать кислотные, щелочные, восковые средства, а также металлические мочалки.

• For the best performance of the mosaic we recommend the use of epoxy mortars (class RG - EN 13888/ISO 13007) or decorative resins-cement, following the manufacturer's instructions. - Al fine di ottenere una resa ottimale del mosaico, è consigliato l'utilizzo di malte epossidiche (classe RG - EN 13888/ISO 13007) o di resine cementizie attenendosi alle indicazioni di utilizzo fornite dal produttore. - Afin d'obtenir un rendu optimal de la mosaïque, nous vous conseillons d'utiliser des mortiers époxy (classe RG - EN 13888/ISO 13007) ou des résines à base de ciment, en suivant les indications d'utilisation fournies par le fabricant. - Um das Mosaik optimal zur Geltung zu bringen, empfehlen wir die Verwendung von Epoxidharzfugenmörtel (Klasse RG - EN 13888/ISO 13007) oder von vergüteten Fugenmörteln unter Beachtung der vom Hersteller angegebenen Verwendungshinweise. - Para obtener un rendimiento óptimo del mosaico, se aconseja utilizar mortero epoxi (clase RG - EN 13888/ISO 13007) o resinas de cemento siguiendo las indicaciones entregadas por el fabricante. - Для наилучшего эстетического результата при укладке мозаики рекомендуется использовать эпоксидные растворы (класс RG - EN 13888/ISO 13007) или полимерцемент, соблюдая инструкции производителя.

INDEX



PRODUCT  
FINDER



SURFACE  
RANGE



COMPANY



COLLECTIONS



- 3D WALL
- CONCRETE & RESIN LOOK
- METAL LOOK
- MARBLE LOOK
- STONE LOOK
- WOOD LOOK

LARGE SIZES



TECHNICAL  
SPECIFICATIONS



# Raw Wall Tiles

## DECOR RANGE



9RTW Raw White ♦  
Mosaico Twist  
35,8x31 - 14<sup>1</sup>/<sub>8</sub>"x12<sup>1</sup>/<sub>4</sub>"



9RTP Raw Pearl ♦  
Mosaico Twist  
35,8x31 - 14<sup>1</sup>/<sub>8</sub>"x12<sup>1</sup>/<sub>4</sub>"



9RTS Raw Sand ♦  
Mosaico Twist  
35,8x31 - 14<sup>1</sup>/<sub>8</sub>"x12<sup>1</sup>/<sub>4</sub>"



9RTB Raw Blue ♦  
Mosaico Twist  
35,8x31 - 14<sup>1</sup>/<sub>8</sub>"x12<sup>1</sup>/<sub>4</sub>"

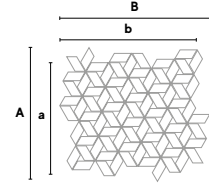

A 36,5 cm - 14<sup>3</sup>/<sub>8</sub>"  
a 31 cm - 12<sup>1</sup>/<sub>4</sub>"  
B 41 cm - 16<sup>1</sup>/<sub>8</sub>"  
b 35,8 cm - 14<sup>1</sup>/<sub>8</sub>"



9RTR Raw Rose ♦  
Mosaico Twist  
35,8x31 - 14<sup>1</sup>/<sub>8</sub>"x12<sup>1</sup>/<sub>4</sub>"



9RTE Raw Petroleum ♦  
Mosaico Twist  
35,8x31 - 14<sup>1</sup>/<sub>8</sub>"x12<sup>1</sup>/<sub>4</sub>"



9RFW Raw White ♦  
Mosaico Flag  
31,1x31,6 - 12<sup>1</sup>/<sub>4</sub>"x12<sup>1</sup>/<sub>2</sub>"



9RFP Raw Pearl ♦  
Mosaico Flag  
31,1x31,6 - 12<sup>1</sup>/<sub>4</sub>"x12<sup>1</sup>/<sub>2</sub>"



9RFS Raw Sand ♦  
Mosaico Flag  
31,1x31,6 - 12<sup>1</sup>/<sub>4</sub>"x12<sup>1</sup>/<sub>2</sub>"



9RFB Raw Blue ♦  
Mosaico Flag  
31,1x31,6 - 12<sup>1</sup>/<sub>4</sub>"x12<sup>1</sup>/<sub>2</sub>"

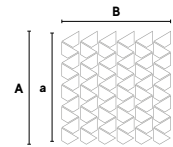

A 32,6 cm - 12<sup>1</sup>/<sub>8</sub>"  
a 31,5 cm - 12<sup>3</sup>/<sub>8</sub>"  
B 31,1 cm - 12<sup>1</sup>/<sub>4</sub>"



9RFR Raw Rose ♦  
Mosaico Flag  
31,1x31,6 - 12<sup>1</sup>/<sub>4</sub>"x12<sup>1</sup>/<sub>2</sub>"



9RFE Raw Petroleum ♦  
Mosaico Flag  
31,1x31,6 - 12<sup>1</sup>/<sub>4</sub>"x12<sup>1</sup>/<sub>2</sub>"

♦ For the best performance of the mosaic we recommend the use of epoxy mortars (class RG - EN 13888/ISO 13007) or decorative resins-cement, following the manufacturer's instructions. - Al fine di ottenere una resa ottimale del mosaico, è consigliato l'utilizzo di malte epossidiche (classe RG - EN 13888/ISO 13007) o di resine cementizie attenendosi alle indicazioni di utilizzo fornite dal produttore. - Afin d'obtenir un rendu optimal de la mosaïque, nous vous conseillons d'utiliser des mortiers époxy (classe RG - EN 13888/ISO 13007) ou des résines à base de ciment, en suivant les indications d'utilisation fournies par le fabricant. - Um das Mosaik optimal zur Geltung zu bringen, empfehlen wir die Verwendung von Epoxidharzfügenmörtel (Klasse RG - EN 13888/ISO 13007) oder von vergüteten Fugenmörteln unter Beachtung der vom Hersteller angegebenen Verwendungshinweise. - Para obtener un rendimiento óptimo del mosaico, se aconseja utilizar mortero epoxi (clase RG - EN 13888/ISO 13007) o resinas de cemento siguiendo las indicaciones entregadas por el fabricante. - Для наилучшего эстетического результата при укладке мозаики рекомендуется использовать эпоксидные растворы (класс RG - EN 13888/ISO 13007) или полимерцемент, соблюдая инструкции производителя.



© Ceramiche Atlas Concorde



© Ceramiche Atlas Concorde



© Ceramiche Atlas Concorde

INDEX



PRODUCT  
FINDER



SURFACE  
RANGE



COMPANY



COLLECTIONS



3D WALL

CONCRETE & RESIN LOOK

METAL LOOK

MARBLE LOOK

STONE LOOK

WOOD LOOK

LARGE SIZES



TECHNICAL  
SPECIFICATIONS



# Venti Boost

DOWNLOAD >  
CATALOG &  
IMAGE GALLERY

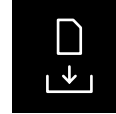

ENJOY THE  
VIDEO

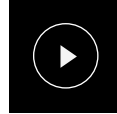

© Ceramiche Atlas Concorde



© Ceramiche Atlas Concorde



© Ceramiche Atlas Concorde

## Porcelain Tiles



### COLOURED BODY PORCELAIN TILES - NON RECTIFIED

Sizes	Thickness	Surface finish
20x20 cm - 7 7/8" x 7 7/8"	± 9 mm	Matte R10 A

## Glazed Porcelain Tiles



### GLAZED PORCELAIN TILES - NON RECTIFIED

Sizes	Thickness	Surface finish
20x20 cm - 7 7/8" x 7 7/8"	± 9 mm	Matte R9 A

Coloured body porcelain tiles – Gres porcellanato colorato in massa – Grés cérame coloré dans la masse – Durchgefärbtes Feinsteinzeug – Gres porcelánico coloreado en masa – Керамический гранит окрашенный в массу  
 Glazed porcelain tiles – Gres Porcellanato Smaltato – Grés cérame émaillé – Glasiertes Feinsteinzeug – Gres porcelánico esmaltado – Глазурованный керамический гранит  
 Non rectified – Non rettificato – Non rectifié – Nicht rektifiziert – No rectificada – Неретифицированные

INDEX



PRODUCT  
FINDER



SURFACE  
RANGE



COMPANY



COLLECTIONS



- 3D WALL
- CONCRETE & RESIN LOOK
- METAL LOOK
- MARBLE LOOK
- STONE LOOK
- WOOD LOOK

LARGE SIZES



TECHNICAL  
SPECIFICATIONS



# Venti Boost

## Porcelain Tiles



### MATTE SURFACE



A3OD Venti Boost Warm  
20x20 - 7 1/8" x 7 1/8"



A3OF Venti Boost Mix Warm ▲  
20x20 - 7 1/8" x 7 1/8"



A3OJ Venti Boost Carpet 1W  
20x20 - 7 1/8" x 7 1/8"



A3OK Venti Boost Carpet 2W  
20x20 - 7 1/8" x 7 1/8"



A3OL Venti Boost Carpet 3W  
20x20 - 7 1/8" x 7 1/8"

### MATTE SURFACE



A3OC Venti Boost Cold  
20x20 - 7 1/8" x 7 1/8"



A3OE Venti Boost Mix Cold ▲  
20x20 - 7 1/8" x 7 1/8"



A3OG Venti Boost Carpet 1C  
20x20 - 7 1/8" x 7 1/8"



A3OH Venti Boost Carpet 2C  
20x20 - 7 1/8" x 7 1/8"



A3OI Venti Boost Carpet 3C  
20x20 - 7 1/8" x 7 1/8"

▲ Article composed of 16 different graphics, randomly mixed inside the boxes. - Articolo composto da 16 grafiche diverse, miscelate in modo casuale all'interno delle scatole. - Article composé de 16 graphismes différents, mélangés au hasard dans les boîtes. - Artikel mit 16 verschiedenen Grafiken, in den Schachteln nach dem Zufallsprinzip gemischt. - Artículo compuesto por 16 gráficos diferentes, mezclados en manera casual dentro a las cajas. - Артикул состоит из 16 различных рисунков, случайно перемешанных внутри коробок.

\* Carpet 1 Warm, Carpet 2 Warm, Carpet 3 Warm, Carpet 1 Cold, Carpet 2 Cold, Carpet 3 Cold  
\*\* Mix Warm, Mix Cold

INDEX



PRODUCT  
FINDER



SURFACE  
RANGE



COMPANY



COLLECTIONS



- 3D WALL
- CONCRETE & RESIN LOOK
- METAL LOOK
- MARBLE LOOK
- STONE LOOK
- WOOD LOOK

LARGE SIZES



TECHNICAL  
SPECIFICATIONS



# Venti Boost

## Glazed Porcelain Tiles



Matte ± 9 mm

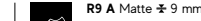

R9 A Matte ± 9 mm

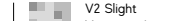

V2 Slight Variation \*

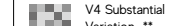

V4 Substantial Variation \*\*

### MATTE SURFACE



A3OM Venti Boost Classic Mix ▲  
20x20 - 7/16"x7/16"

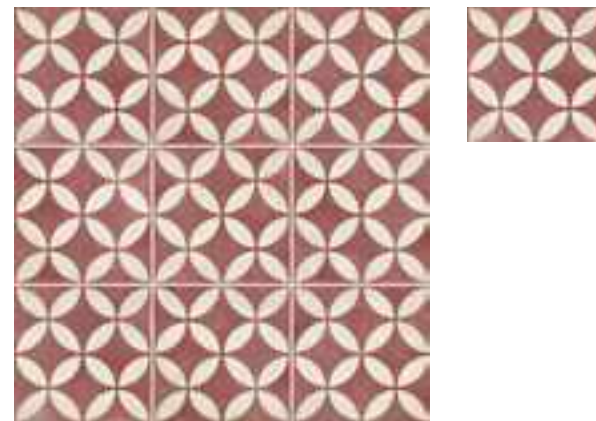

A3ON Venti Boost Classic Carpet 1  
20x20 - 7/16"x7/16"



A3OO Venti Boost Classic Carpet 2  
20x20 - 7/16"x7/16"

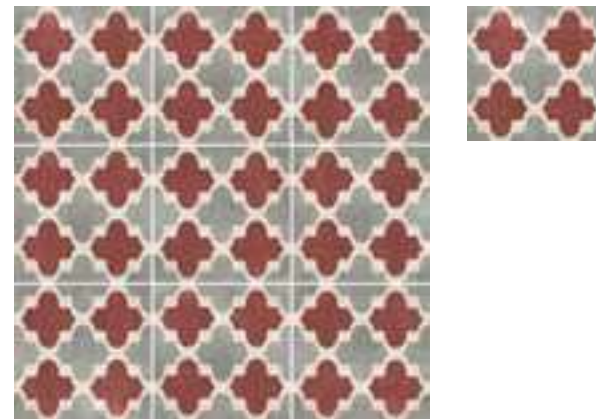

A3OP Venti Boost Classic Carpet 3  
20x20 - 7/16"x7/16"

### MATTE SURFACE



A3OQ Venti Boost Blue Mix ▲  
20x20 - 7/16"x7/16"

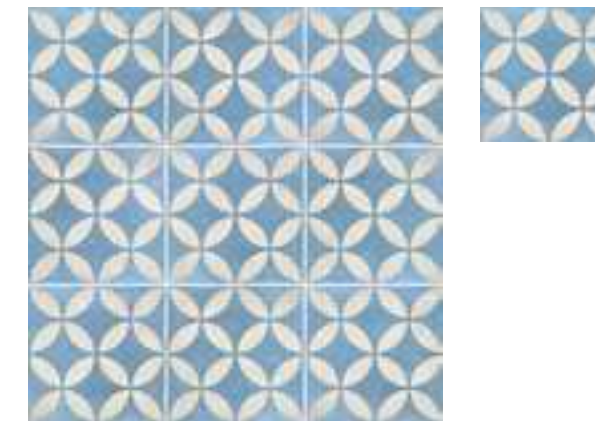

A3OR Venti Boost Blue Carpet 1  
20x20 - 7/16"x7/16"



A3OS Venti Boost Blue Carpet 2  
20x20 - 7/16"x7/16"

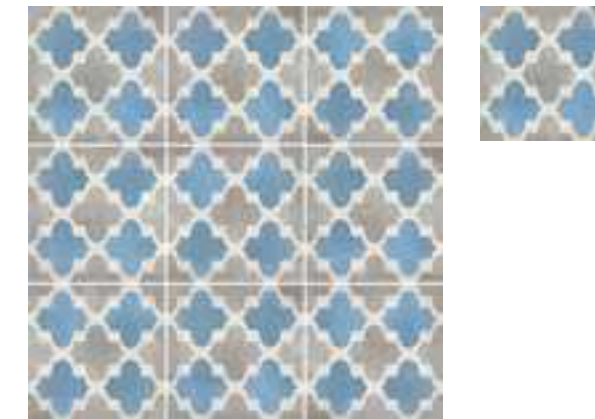

A3OT Venti Boost Blue Carpet 3  
20x20 - 7/16"x7/16"

▲ Article composed of 20 different graphics, randomly mixed inside the boxes. - Articolo composto da 20 grafiche diverse, miscelate in modo casuale all'interno delle scatole. - Article composé de 20 graphismes différents, mélangés au hasard dans les boîtes. - Artikel mit 20 verschiedenen Grafiken, in den Schachteln nach dem Zufallsprinzip gemischt. - Artículo compuesto por 20 gráficos diferentes, mezclados en manera casual dentro a las cajas. - Артикул состоит из 20 различных рисунков, случайно перемешанных внутри коробок.

\* Classic Carpet 1, Classic Carpet 2, Classic Carpet 3, Blue Carpet 1, Blue Carpet 2, Blue Carpet 3  
\*\* Classic Mix, Blue Mix

INDEX



PRODUCT  
FINDER



SURFACE  
RANGE



COMPANY



COLLECTIONS



3D WALL

CONCRETE & RESIN LOOK

METAL LOOK

MARBLE LOOK

STONE LOOK

WOOD LOOK

LARGE SIZES



TECHNICAL  
SPECIFICATIONS



# Aplomb

DOWNLOAD >  
CATALOG &  
IMAGE GALLERY

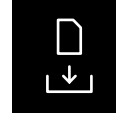

ENJOY THE  
VIDEO

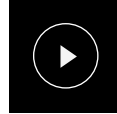

© Ceramiche Atlas Concorde



© Ceramiche Atlas Concorde



© Ceramiche Atlas Concorde

## Wall Tiles

### WHITEBODY WALL TILES - RECTIFIED MONOCALIBER

**Sizes**  
50x120 cm - 19 5/8" x 47 1/4"

**Thickness**  
8,5 mm

**Surface finish**  
Matte



**Whitebody wall tiles** - Rivestimenti in pasta bianca - Revêtements en pâte blanche - Weißscherbige Wandfliesen - Revestimientos en pasta blanca - Настенная плитка из белой глины  
**Rectified monocaliber** - Rettificato monocalibro - Rectifié mono-calibre - Geschliffen einkalbrig - Rectificado monocalibre - Ретифицированный в одном калибре

INDEX



PRODUCT  
FINDER



SURFACE  
RANGE



COMPANY



COLLECTIONS



- 3D WALL
- CONCRETE & RESIN LOOK
- METAL LOOK
- MARBLE LOOK
- STONE LOOK
- WOOD LOOK

LARGE SIZES



TECHNICAL  
SPECIFICATIONS





# Aplomb Wall Tiles

## MATTE SURFACE



V1 Uniform Appearance



± 8,5 mm

50x120 cm - 19<sup>5</sup>/<sub>8</sub>"x47<sup>1</sup>/<sub>4</sub>"

- A6E5 Aplomb Canvas Minidots
- A6E4 Aplomb Cream Minidots
- A6E3 Aplomb White Minidots
- A6E6 Aplomb Denim Minidots
- AGIL Aplomb Lichen Minidots
- A6E9 Aplomb Canvas Stripes
- A6E8 Aplomb Cream Stripes
- A6E7 Aplomb White Stripes
- A6FA Aplomb Denim Stripes
- AGIM Aplomb Lichen Stripes



## TRIM TILES



1,4x50 cm - 5<sup>5</sup>/<sub>8</sub>"x19<sup>5</sup>/<sub>8</sub>"

- A6NH Aplomb Canvas Minidots Corner 50 \*
- A6NG Aplomb Cream Minidots Corner 50 \*
- A6NF Aplomb White Minidots Corner 50 \*
- A6NJ Aplomb Denim Minidots Corner 50 \*
- A6NI Aplomb Lichen Minidots Corner 50 \*
- A6NM Aplomb Canvas Stripes Corner 50 \*
- A6NL Aplomb Cream Stripes Corner 50 \*
- A6NK Aplomb White Stripes Corner 50 \*
- A6NO Aplomb Denim Stripes Corner 50 \*
- A6NN Aplomb Lichen Stripes Corner 50 \*



1,4x1,4 cm - 5<sup>5</sup>/<sub>8</sub>"x5<sup>5</sup>/<sub>8</sub>"

- A6NR Aplomb Canvas Minidots Corner A.E \*
- A6NQ Aplomb Cream Minidots Corner A.E \*
- A6NP Aplomb White Minidots Corner A.E \*
- A6NT Aplomb Denim Minidots Corner A.E \*
- A6NS Aplomb Lichen Minidots Corner A.E \*
- A6NW Aplomb Canvas Stripes Corner A.E \*
- A6NV Aplomb Cream Stripes Corner A.E \*
- A6NU Aplomb White Stripes Corner A.E \*
- A6NY Aplomb Denim Stripes Corner A.E \*
- A6NX Aplomb Lichen Stripes Corner A.E \*

\* These parts are supplied to order - I pezzi sono disponibili su ordinazione - Les pièces sont disponibles sur commande - Die Teile sind auf Bestellung lieferbar - Las piezas se hacen por encargo - Изготавливаются на заказ  
Matte surface - Superficie matt - Surface Mat - Matte Oberfläche - Superficie Mate - Матовая поверхность



© Ceramiche Atlas Concorde



© Ceramiche Atlas Concorde



© Ceramiche Atlas Concorde

INDEX



PRODUCT  
FINDER



SURFACE  
RANGE



COMPANY



COLLECTIONS



3D WALL

CONCRETE & RESIN LOOK

METAL LOOK

MARBLE LOOK

STONE LOOK

WOOD LOOK

LARGE SIZES



TECHNICAL  
SPECIFICATIONS



# Aplomb

## Wall Tiles

### DECOR RANGE

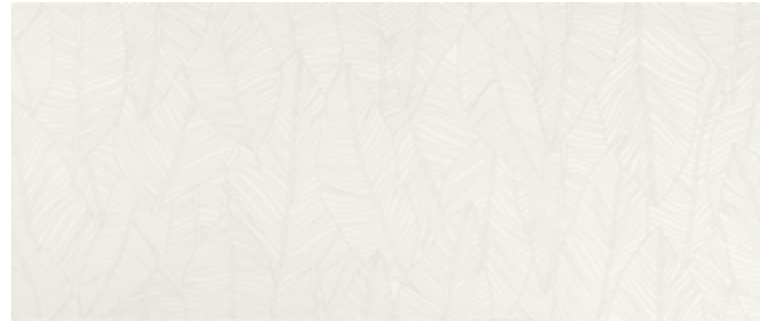

A6FC Aplomb White Leaf  
50x120 cm - 19<sup>5</sup>/<sub>8</sub>"x47<sup>1</sup>/<sub>4</sub>"



A6FD Aplomb Canvas Leaf  
50x120 cm - 19<sup>5</sup>/<sub>8</sub>"x47<sup>1</sup>/<sub>4</sub>"



A6SH Aplomb Cream Leaf Lux  
50x120 cm - 19<sup>5</sup>/<sub>8</sub>"x47<sup>1</sup>/<sub>4</sub>"

It can be combined with / Abbinabile con / Peut être combiné avec /  
Kombinierbar mit / Combinable con / Совместимы с:  
**Minidots Cream - Stripes Cream**



A6SI Aplomb Lichen Leaf Lux  
50x120 cm - 19<sup>5</sup>/<sub>8</sub>"x47<sup>1</sup>/<sub>4</sub>"

It can be combined with / Abbinabile con / Peut être combiné avec /  
Kombinierbar mit / Combinable con / Совместимы с:  
**Minidots Lichen - Stripes Lichen**



A6SJ Aplomb Canvas Flora  
50x120 cm - 19<sup>5</sup>/<sub>8</sub>"x47<sup>1</sup>/<sub>4</sub>"

It can be combined with / Abbinabile con / Peut être combiné avec /  
Kombinierbar mit / Combinable con / Совместимы с:  
**Minidots Canvas**

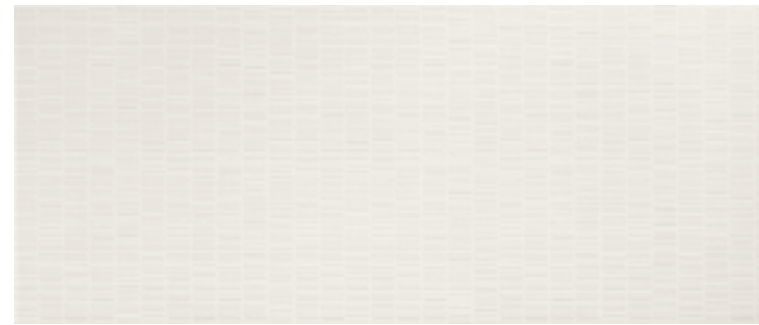

A6FB Aplomb White Mesh  
50x120 cm - 19<sup>5</sup>/<sub>8</sub>"x47<sup>1</sup>/<sub>4</sub>"

Item sold by square meter. / Articolo venduto al mq. / Article vendu  
au mètre carré. / Artikel pro m2 verkauft. / Artículo vendido por m2. /  
Артикул продается квадратными метрами.



A6VØ Aplomb Fabric Light  
50x120 cm - 19<sup>5</sup>/<sub>8</sub>"x47<sup>1</sup>/<sub>4</sub>"

It can be combined with / Abbinabile con / Peut être combiné avec /  
Kombinierbar mit / Combinable con / Совместимы с:  
**Minidots Cream**



A6V1 Aplomb Fabric Dark  
50x120 cm - 19<sup>5</sup>/<sub>8</sub>"x47<sup>1</sup>/<sub>4</sub>"

It can be combined with / Abbinabile con / Peut être combiné avec /  
Kombinierbar mit / Combinable con / Совместимы с:  
**Minidots Lichen - Minidots Cream**



A6SP Aplomb White  
Mosaico Triangle ▲  
31,5x30,5 - 12<sup>7</sup>/<sub>8</sub>"x12"

A6SQ Aplomb Cream  
Mosaico Triangle ▲  
31,5x30,5 - 12<sup>7</sup>/<sub>8</sub>"x12"

A6SR Aplomb Canvas  
Mosaico Triangle ▲  
31,5x30,5 - 12<sup>7</sup>/<sub>8</sub>"x12"

A6SS Aplomb Lichen  
Mosaico Triangle ▲  
31,5x30,5 - 12<sup>7</sup>/<sub>8</sub>"x12"

A6ST Aplomb Denim  
Mosaico Triangle ▲  
31,5x30,5 - 12<sup>7</sup>/<sub>8</sub>"x12"

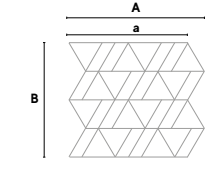

A 35,9 cm - 15<sup>1</sup>/<sub>8</sub>"  
a 30,5 cm - 12"  
B 31,5 cm - 12<sup>7</sup>/<sub>8</sub>"



A6SK Aplomb White  
Mosaico Arch ▲  
32x32 - 12<sup>5</sup>/<sub>8</sub>"x12<sup>5</sup>/<sub>8</sub>"

A6SL Aplomb Cream  
Mosaico Arch ▲  
32x32 - 12<sup>5</sup>/<sub>8</sub>"x12<sup>5</sup>/<sub>8</sub>"

A6SM Aplomb Canvas  
Mosaico Arch ▲  
32x32 - 12<sup>5</sup>/<sub>8</sub>"x12<sup>5</sup>/<sub>8</sub>"

A6SN Aplomb Lichen  
Mosaico Arch ▲  
32x32 - 12<sup>5</sup>/<sub>8</sub>"x12<sup>5</sup>/<sub>8</sub>"

A6SO Aplomb Denim  
Mosaico Arch ▲  
32x32 - 12<sup>5</sup>/<sub>8</sub>"x12<sup>5</sup>/<sub>8</sub>"

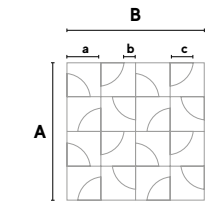

A 32 cm - 12<sup>5</sup>/<sub>8</sub>"  
B 32 cm - 12<sup>5</sup>/<sub>8</sub>"  
a 7,8 cm - 3<sup>1</sup>/<sub>8</sub>"  
b 2,533 cm - 1"  
c 5,167 cm - 2"



A6SU Aplomb White  
Mosaico Net ◆  
30x30 - 11<sup>1</sup>/<sub>4</sub>"x11<sup>1</sup>/<sub>4</sub>"

A6SV Aplomb Cream  
Mosaico Net ◆  
30x30 - 11<sup>1</sup>/<sub>4</sub>"x11<sup>1</sup>/<sub>4</sub>"

A6SW Aplomb Canvas  
Mosaico Net ◆  
30x30 - 11<sup>1</sup>/<sub>4</sub>"x11<sup>1</sup>/<sub>4</sub>"

A6SX Aplomb Lichen  
Mosaico Net ◆  
30x30 - 11<sup>1</sup>/<sub>4</sub>"x11<sup>1</sup>/<sub>4</sub>"

A6SY Aplomb Denim  
Mosaico Net ◆  
30x30 - 11<sup>1</sup>/<sub>4</sub>"x11<sup>1</sup>/<sub>4</sub>"

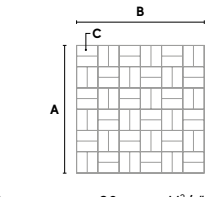

A 30 cm - 11<sup>1</sup>/<sub>4</sub>"  
B 30 cm - 11<sup>1</sup>/<sub>4</sub>"  
C 4,88x2,36 cm - 1<sup>7</sup>/<sub>8</sub>"x2<sup>3</sup>/<sub>8</sub>"

▲ The tesserae come from Minidots and Stripes Textures - Le tessere sono ricavate dalle texture minidots e stripes - Les tesselles proviennent des textures minidots et stripes - Die Mosaiksteinchen stammen aus den Textures Minidots und Stripes - Los mosaicos se obtienen de las texturas minidots y stripes - Тессеры вырезаны из структур minidots и stripes

◆ The tesserae come from Minidots Textures - Le tessere sono ricavate dalle texture minidots - Les tesselles proviennent des Textures Minidots - Die Mosaiksteinchen stammen aus den Textures Minidots - Los mosaicos se obtienen de las texturas minidots - Тессеры вырезаны из структур Minidots

INDEX



PRODUCT  
FINDER



SURFACE  
RANGE



COMPANY



COLLECTIONS



- 3D WALL
- CONCRETE & RESIN LOOK
- METAL LOOK
- MARBLE LOOK
- STONE LOOK
- WOOD LOOK

LARGE SIZES



TECHNICAL  
SPECIFICATIONS



# Arty



© Ceramiche Atlas Concorde



© Ceramiche Atlas Concorde



© Ceramiche Atlas Concorde

## Wall Tiles



### WHITEBODY WALL TILES - RECTIFIED MONOCALIBER

Sizes	Thickness	Surface finish
40x80 cm - 15 <sup>3</sup> / <sub>4</sub> "x31 <sup>1</sup> / <sub>2</sub> "	± 8,5 mm	Matte
<b>3D WALL TILES</b> 40x80 cm - 15 <sup>3</sup> / <sub>4</sub> "x31 <sup>1</sup> / <sub>2</sub> "	± 10 mm	Matte

**Whitebody wall tiles** – Rivestimenti in pasta bianca – Revêtements en pâte blanche – Weißscherbige Wandfliesen – Revestimientos en pasta blanca – Настенная плитка из белой глины  
**Rectified monocaliber** – Rettificato monocalibro – Rectifié mono-calibre – Geschliffen einkalbrig – Rectificado monocalibre – Ретифицированный в одном калибре

INDEX



PRODUCT  
FINDER



SURFACE  
RANGE



COMPANY



COLLECTIONS



- 3D WALL
- CONCRETE & RESIN LOOK
- METAL LOOK
- MARBLE LOOK
- STONE LOOK
- WOOD LOOK

LARGE SIZES



TECHNICAL  
SPECIFICATIONS



# Arty Wall Tiles

## MATTE SURFACE



± 8.5 mm  
**40x80 cm** - 15<sup>3</sup>/<sub>4</sub>"x31<sup>1</sup>/<sub>2</sub>"  
 8ARU Arty Sugar  
 8ARL Arty Milk  
 8ARA Arty Charcoal  
 8ARN Arty Malt  
 8ARD Arty Curry  
 8ARB Arty Tabasco

± 10 mm 3D WALL  
**40x80 cm** - 15<sup>3</sup>/<sub>4</sub>"x31<sup>1</sup>/<sub>2</sub>"  
 8AWS Arty Sugar Wave  
 8AWM Arty Milk Wave

## TRIM TILES

LASS Arty Sugar Spigolo 0,8x20 - 3 <sup>1</sup> / <sub>8</sub> "x7 <sup>7</sup> / <sub>8</sub> "	AASS Spigolo A.E. 0,8x0,8 - 3 <sup>1</sup> / <sub>8</sub> "x3 <sup>1</sup> / <sub>8</sub> "
LASH Arty Charcoal Spigolo 0,8x20 - 3 <sup>1</sup> / <sub>8</sub> "x7 <sup>7</sup> / <sub>8</sub> "	AASH Spigolo A.E. 0,8x0,8 - 3 <sup>1</sup> / <sub>8</sub> "x3 <sup>1</sup> / <sub>8</sub> "
LASC Arty Curry Spigolo 0,8x20 - 3 <sup>1</sup> / <sub>8</sub> "x7 <sup>7</sup> / <sub>8</sub> "	AASU Spigolo A.E. 0,8x0,8 - 3 <sup>1</sup> / <sub>8</sub> "x3 <sup>1</sup> / <sub>8</sub> "
LASK Arty Milk Spigolo 0,8x20 - 3 <sup>1</sup> / <sub>8</sub> "x7 <sup>7</sup> / <sub>8</sub> "	AASI Spigolo A.E. 0,8x0,8 - 3 <sup>1</sup> / <sub>8</sub> "x3 <sup>1</sup> / <sub>8</sub> "
LASD Arty Malt Spigolo 0,8x20 - 3 <sup>1</sup> / <sub>8</sub> "x7 <sup>7</sup> / <sub>8</sub> "	AASM Spigolo A.E. 0,8x0,8 - 3 <sup>1</sup> / <sub>8</sub> "x3 <sup>1</sup> / <sub>8</sub> "
LASO Arty Tabasco Spigolo 0,8x20 - 3 <sup>1</sup> / <sub>8</sub> "x7 <sup>7</sup> / <sub>8</sub> "	AASO Spigolo A.E. 0,8x0,8 - 3 <sup>1</sup> / <sub>8</sub> "x3 <sup>1</sup> / <sub>8</sub> "



## DECOR RANGE



8ATM Arty Milk Textile  
40x80 - 15<sup>3</sup>/<sub>4</sub>"x31<sup>1</sup>/<sub>2</sub>"

8ATT Arty Tabasco Textile  
40x80 - 15<sup>3</sup>/<sub>4</sub>"x31<sup>1</sup>/<sub>2</sub>"

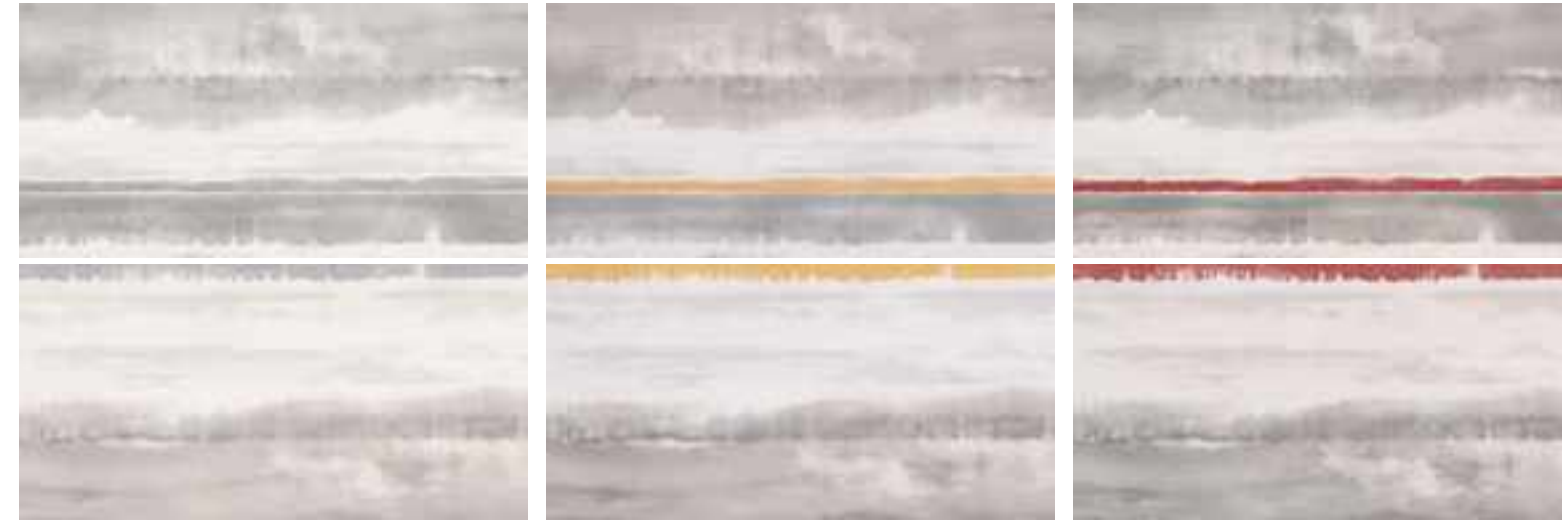

8A2S Arty Sugar Urban C2  
80x80 - 31<sup>1</sup>/<sub>2</sub>"x31<sup>1</sup>/<sub>2</sub>"

8A2C Arty Curry Urban C2  
80x80 - 31<sup>1</sup>/<sub>2</sub>"x31<sup>1</sup>/<sub>2</sub>"

8A2T Arty Tabasco Urban C2  
80x80 - 31<sup>1</sup>/<sub>2</sub>"x31<sup>1</sup>/<sub>2</sub>"



9ASS Arty Sugar  
Mosaico Minibrick  
30,5x30,5 - 12"x12"



9ASH Arty Charcoal  
Mosaico Minibrick  
30,5x30,5 - 12"x12"



9ASC Arty Curry  
Mosaico Minibrick  
30,5x30,5 - 12"x12"



9ASI Arty Milk  
Mosaico Minibrick  
30,5x30,5 - 12"x12"



9ASM Arty Malt  
Mosaico Minibrick  
30,5x30,5 - 12"x12"



9AST Arty Tabasco  
Mosaico Minibrick  
30,5x30,5 - 12"x12"

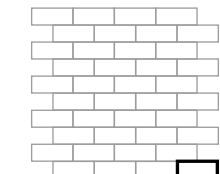

2,8x7,3 cm  
1<sup>1</sup>/<sub>8</sub>"x2<sup>7</sup>/<sub>8</sub>"

INDEX



PRODUCT  
FINDER



SURFACE  
RANGE



COMPANY



COLLECTIONS



- 3D WALL
- CONCRETE & RESIN LOOK
- METAL LOOK
- MARBLE LOOK
- STONE LOOK
- WOOD LOOK

LARGE SIZES



TECHNICAL  
SPECIFICATIONS



# Blaze

DOWNLOAD >  
CATALOG &  
IMAGE GALLERY

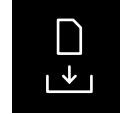

ENJOY THE  
VIDEO

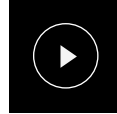

© Ceramiche Atlas Concorde



© Ceramiche Atlas Concorde



© Ceramiche Atlas Concorde

## Porcelain Tiles

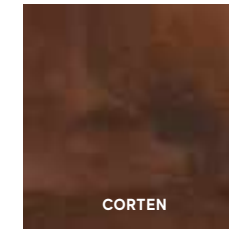
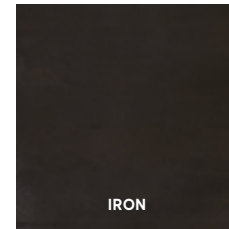

### COLOURED BODY PORCELAIN TILES - RECTIFIED MONOCALIBER

Sizes	Thickness	Surface finish
162x324 cm - 63 <sup>3</sup> / <sub>4</sub> "x127 <sup>1</sup> / <sub>2</sub> " > NON RECTIFIED	± 12 mm	Matte
120x278 cm - 47 <sup>1</sup> / <sub>4</sub> "x109 <sup>1</sup> / <sub>2</sub> "	± 6 mm	Matte R9 A
120x120 cm - 47 <sup>1</sup> / <sub>4</sub> "x47 <sup>1</sup> / <sub>4</sub> "	± 9 mm	Matte R10 A+B
75x150 cm - 29 <sup>1</sup> / <sub>2</sub> "x59"	± 9 mm	Polished   Matte R10 A+B
75x75 cm - 29 <sup>1</sup> / <sub>2</sub> "x29 <sup>1</sup> / <sub>2</sub> "	± 9 mm	Polished   Matte R10 A+B
37,5x75 cm - 14 <sup>3</sup> / <sub>4</sub> "x29 <sup>1</sup> / <sub>2</sub> "	± 9 mm	Matte R10 A+B

LARGE SIZES p. 390

### OUTDOOR AND WET AREAS

Sizes	Thickness	Surface finish
37,5x75 cm - 14 <sup>3</sup> / <sub>4</sub> "x29 <sup>1</sup> / <sub>2</sub> "	± 9 mm	Grip R11 A+B+C
120x120 cm - 47 <sup>1</sup> / <sub>4</sub> "x47 <sup>1</sup> / <sub>4</sub> "	± 20 mm	Outdoor R11 A+B+C
60x60 cm - 23 <sup>5</sup> / <sub>8</sub> "x23 <sup>5</sup> / <sub>8</sub> "	± 20 mm	Outdoor R11 A+B+C

## Wall Tiles

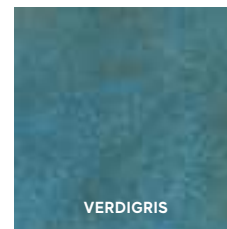
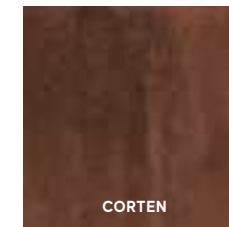
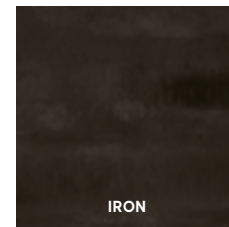
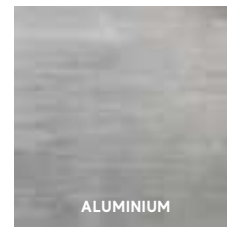

### WHITEBODY WALL TILES - RECTIFIED MONOCALIBER

Sizes	Thickness	Surface finish
50x120 cm - 19 <sup>5</sup> / <sub>8</sub> "x47 <sup>1</sup> / <sub>4</sub> "	± 8,5 mm	Matte

Coloured body porcelain tiles – Gres porcellanato colorato in massa – Grès cérame coloré dans la masse – Durchgefärbtes Feinsteinzeug – Gres porcelánico coloreado en masa – Керамический гранит окрашенный в массе  
 Whitebody wall tiles – Rivestimenti in pasta bianca – Revêtements en pâte blanche – Weißscherbige Wandfliesen – Revestimientos en pasta blanca – Настенная плитка из белой глины  
 Rectified monocaliber – Rettificato monocalibro – Rectifié mono-calibre – Geschliffen einkalbrig – Rectificado monocalibre – Ретифицированный в одном калибре  
 Non rectified – Non rettificato – Non rectifié – Nicht rektifiziert – No rectificada – Неретифицированные

INDEX



PRODUCT  
FINDER



SURFACE  
RANGE



COMPANY



COLLECTIONS



- 3D WALL
- CONCRETE & RESIN LOOK
- METAL LOOK
- MARBLE LOOK
- STONE LOOK
- WOOD LOOK

LARGE SIZES



TECHNICAL  
SPECIFICATIONS



# Blaze

## Porcelain Tiles



Matte ± 6 mm  
Polished ± 9 mm



Matte ± 9 mm  
Grip ± 9 mm  
Outdoor ± 20 mm



R9 A Matte ± 6 mm  
R10 A+B Matte ± 9 mm  
R11 A+B+C Grip ± 9 mm  
R11 A+B+C Outdoor ± 20 mm



V3 Moderate  
Variation

### MATTE SURFACE



± 6 mm  
**120x278 cm** - 47<sup>1</sup>/<sub>4</sub>"x109<sup>1</sup>/<sub>2</sub>"  
APO7 Blaze Aluminium  
APO8 Blaze Corten  
APO9 Blaze Iron



± 9 mm  
**120x120 cm** - 47<sup>1</sup>/<sub>4</sub>"x47<sup>1</sup>/<sub>4</sub>"  
APPK Blaze Aluminium  
APPW Blaze Corten  
APPX Blaze Iron



± 9 mm  
**75x150 cm** - 29<sup>1</sup>/<sub>2</sub>"x59"  
A7GS Blaze Aluminium  
A7GT Blaze Corten  
A7GU Blaze Iron



± 9 mm  
**75x75 cm** - 29<sup>1</sup>/<sub>2</sub>"x29<sup>1</sup>/<sub>2</sub>"  
APOU Blaze Aluminium  
APOV Blaze Corten  
APOW Blaze Iron



**MATTE**  
**162x324 cm** - 63<sup>3</sup>/<sub>4</sub>"x127<sup>1</sup>/<sub>2</sub>"  
NON RECTIFIED



± 9 mm  
**37.5x75 cm** - 14<sup>3</sup>/<sub>4</sub>"x29<sup>1</sup>/<sub>2</sub>"  
APOØ Blaze Aluminium  
APO5 Blaze Corten  
APO6 Blaze Iron

### POLISHED SURFACE

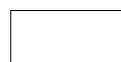

± 9 mm  
**75x150 cm** - 29<sup>1</sup>/<sub>2</sub>"x59"  
A7EY Blaze Aluminium Lapp  
A7E4 Blaze Corten Lapp  
A7E5 Blaze Iron Lapp



± 9 mm  
**75x75 cm** - 29<sup>1</sup>/<sub>2</sub>"x29<sup>1</sup>/<sub>2</sub>"  
APOX Blaze Aluminium Lapp  
APOY Blaze Corten Lapp  
APOZ Blaze Iron Lapp



### GRIP SURFACE



± 9 mm  
**37.5x75 cm** - 14<sup>3</sup>/<sub>4</sub>"x29<sup>1</sup>/<sub>2</sub>"  
AØ1D Blaze Aluminium Grip  
AØ1F Blaze Corten Grip  
AØ1G Blaze Iron Grip

### OUTDOOR ± 20 mm



± 20 mm  
**120x120 cm** - 47<sup>1</sup>/<sub>4</sub>"x47<sup>1</sup>/<sub>4</sub>"  
AØ5F Blaze Corten 20 mm



± 20 mm  
**60x60 cm** - 23<sup>5</sup>/<sub>8</sub>"x23<sup>5</sup>/<sub>8</sub>"  
AØ5G Blaze Corten 20 mm



### TRIM TILES

p. 462



	Battiscopa		Gradino *		Scalino *		Scalin Ang.*		Corner *	Corner A.E *	Battiscopa Sag. Scala *		Elemento L *			
	7,2x150 cm 2 <sup>1</sup> / <sub>8</sub> "x59"	7,2x75 cm 2 <sup>1</sup> / <sub>8</sub> "x29 <sup>1</sup> / <sub>2</sub> "	37,5x75 cm 14 <sup>3</sup> / <sub>4</sub> "x29 <sup>1</sup> / <sub>2</sub> "		37,5x150 cm 14 <sup>3</sup> / <sub>4</sub> "x59"	37,5x75 cm 13"x29 <sup>1</sup> / <sub>2</sub> "	37,5x37,5 cm 14 <sup>3</sup> / <sub>4</sub> "x14 <sup>3</sup> / <sub>4</sub> "		1x120 cm 3 <sup>1</sup> / <sub>8</sub> "x47 <sup>1</sup> / <sub>2</sub> "	1x1 cm 3 <sup>1</sup> / <sub>8</sub> "x1"	7,2x30 cm 2 <sup>7</sup> / <sub>8</sub> "x11 <sup>1</sup> / <sub>4</sub> "	15x75 H. 4 cm 5 <sup>7</sup> / <sub>8</sub> "x29 <sup>1</sup> / <sub>2</sub> " H. 1 <sup>1</sup> / <sub>8</sub> "				
	Lapp.	Matt	Matt		Lapp.	Matt	Lapp.	Matt	Matt	Matt	Matt		Grip			
Aluminium	AØIQ	AØIN	AØIK	AØIH	AØIZ	AØJB	AØIB	AØI5	AØI2	AØJH	AØJE	AØUI	A19Y	AØIT	AØIW	AØJK
Corten	AØIR	AØIO	AØIL	AØII	AØIØ	AØJC	AØI9	AØI6	AØI3	AØJI	AØJF	AØUJ	A19Z	AØIU	AØIX	AØJL
Iron	AØIS	AØIP	AØIM	AØIU	AØI1	AØJD	AØJA	AØI7	AØI4	AØJJ	AØJG	AØUK	A19Ø	AØIV	AØIY	AØJM

\* These parts are supplied to order - I pezzi sono disponibili su ordinazione - Les pièces sont disponibles sur commande - Die Teile sind auf Bestellung lieferbar - Las piezas se hacen por encargo - Изготавливаются на заказ

A polished finish is recommended for low-stress residential or commercial floors where anti-slip performance is not required. The surface's shine and superior ease of cleaning are the result of in-depth studies and extensive technical research aimed at ensuring its durability over time. If the product is in direct contact with the outside, use moisture and dirt absorption devices to prevent scratches. - La finitura lappata è indicata per pavimenti residenziali o commerciali poco sollecitati, laddove non siano richieste prestazioni anticivolo. La lucentezza e l'elevata facilità di pulizia della superficie sono frutto di studi approfonditi e accurate ricerche tecniche volte a garantirne la persistenza nel tempo. Se il prodotto è a diretto contatto con l'esterno, prevedere dei dispositivi di assorbimento dell'umidità e dello sporco per prevenire la formazione di graffi. - La finition semi-polie est indiquée pour les sols résidentiels ou commerciaux à faibles contraintes, où la performance antidérapante n'est pas requise. La brillance et la grande facilité de nettoyage de la surface sont le résultat d'études approfondies et de recherches techniques précises visant à assurer sa persistance dans le temps. Si le produit est en contact direct avec l'extérieur, prévoyez des dispositifs d'absorption de l'humidité et des poussières pour éviter la formation de rayures. - Die Oberflächenversion Gelappt eignet sich für Bodenbeläge in Wohnbereichen bzw. in gering beanspruchten Gewerberäumen, wenn keine Rutschfestigkeit erforderlich ist. Der Glanz und die einfache Reinigung der Oberfläche sind das Resultat eingehender technischer Studien, mit denen die langfristige Beständigkeit sichergestellt wurde. Kommt das Produkt direkt mit der externen Umgebung in Kontakt, so sind Feuchtigkeit und Schmutz mit geeigneten Mitteln aufzunehmen, um Kratzer zu vermeiden. - El acabado lapeado es adecuado para pavimentos residenciales o comerciales con poco tráfico, donde no se requiere un efecto antideslizante. El brillo y la gran facilidad de limpieza de la superficie son el resultado de profundos estudios e investigaciones técnicas precisas para asegurar su persistencia en el tiempo. Si el producto está en contacto directo con el exterior, proporcionar dispositivos de absorción de humedad y suciedad para evitar arañazos. - Лаппатированная поверхность рекомендована для полов жилых и коммерческих помещений с невысокой интенсивностью эксплуатации, в которых от покрытия не требуется характеристик сопротивления скольжению. Блеск и легкая очищаемость являются результатом глубоких исследований, направленных на создание долговечного материала. Если плитка находится в непосредственном контакте с наружной средой, необходимо предусмотреть устройства поглощения влаги и грязи во избежание образования царапин.

**Matte surface** - Superficie matt - Surface Mat - Matte Oberfläche - Superficie Mate - Матовая поверхность  
**Grip surface** - Superficie grip - Surface grip - Grip Oberfläche - Superficie Grip - Grip поверхность  
**Outdoor** - Pavimenti da esterno - Sols d'extérieur - Bodenbeläge für Außenbereiche - Pavimentos para exteriores - Уличная плитка



ALUMINIUM



IRON



CORTEN

INDEX



PRODUCT  
FINDER



SURFACE  
RANGE



COMPANY



COLLECTIONS



3D WALL  
CONCRETE & RESIN LOOK

METAL LOOK

MARBLE LOOK

STONE LOOK

WOOD LOOK

LARGE SIZES



TECHNICAL  
SPECIFICATIONS



# Blaze

## Porcelain Tiles

### DECOR RANGE



AØUR Blaze Aluminium  
Mosaico 3D Factory  
29x29 - 1<sup>1</sup>/<sub>8</sub>"x1<sup>1</sup>/<sub>8</sub>"



AØUS Blaze Corten  
Mosaico 3D Factory  
29x29 - 1<sup>1</sup>/<sub>8</sub>"x1<sup>1</sup>/<sub>8</sub>"



AØUT Blaze Iron  
Mosaico 3D Factory  
29x29 - 1<sup>1</sup>/<sub>8</sub>"x1<sup>1</sup>/<sub>8</sub>"

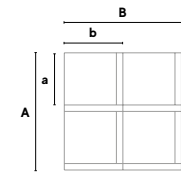

**A** 29 cm - 1<sup>1</sup>/<sub>8</sub>"  
**a** 12,9 cm - 5<sup>1</sup>/<sub>8</sub>"  
**B** 29 cm - 1<sup>1</sup>/<sub>8</sub>"  
**b** 14,5 cm - 5<sup>7</sup>/<sub>8</sub>"



AØUL Blaze Aluminium  
Mosaico Esagono Lapp  
35,2x30,5 - 13<sup>7</sup>/<sub>8</sub>"x12"



AØUM Blaze Corten  
Mosaico Esagono Lapp  
35,2x30,5 - 13<sup>7</sup>/<sub>8</sub>"x12"



AØUN Blaze Iron  
Mosaico Esagono Lapp  
35,2x30,5 - 13<sup>7</sup>/<sub>8</sub>"x12"

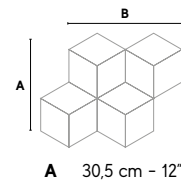

**A** 30,5 cm - 12"  
**B** 35,2 cm - 13<sup>7</sup>/<sub>8</sub>"



AØUO Blaze Aluminium  
Mosaico Esagono Matt  
35,2x30,5 - 13<sup>7</sup>/<sub>8</sub>"x12"



AØUP Blaze Corten  
Mosaico Esagono Matt  
35,2x30,5 - 13<sup>7</sup>/<sub>8</sub>"x12"



AØUQ Blaze Iron  
Mosaico Esagono Matt  
35,2x30,5 - 13<sup>7</sup>/<sub>8</sub>"x12"



AØUX Blaze Aluminium  
Mosaico Matt  
30x30 - 1<sup>1</sup>/<sub>4</sub>"x1<sup>1</sup>/<sub>4</sub>"



AØUY Blaze Corten  
Mosaico Matt  
30x30 - 1<sup>1</sup>/<sub>4</sub>"x1<sup>1</sup>/<sub>4</sub>"



AØUZ Blaze Iron  
Mosaico Matt  
30x30 - 1<sup>1</sup>/<sub>4</sub>"x1<sup>1</sup>/<sub>4</sub>"

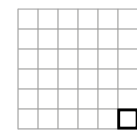

4,8x4,8 cm  
1<sup>7</sup>/<sub>8</sub>"x1<sup>7</sup>/<sub>8</sub>"

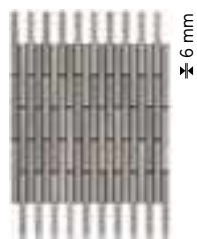

AØUU Blaze Aluminium  
Mosaico Twin  
36,1x29,4 - 14<sup>1</sup>/<sub>4</sub>"x11<sup>5</sup>/<sub>8</sub>"

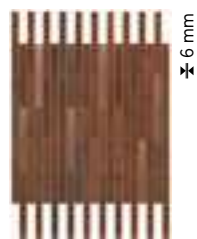

AØUV Blaze Corten  
Mosaico Twin  
36,1x29,4 - 14<sup>1</sup>/<sub>4</sub>"x11<sup>5</sup>/<sub>8</sub>"

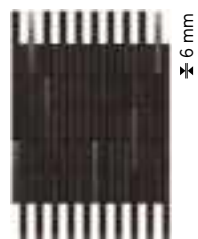

AØUW Blaze Iron  
Mosaico Twin  
36,1x29,4 - 14<sup>1</sup>/<sub>4</sub>"x11<sup>5</sup>/<sub>8</sub>"

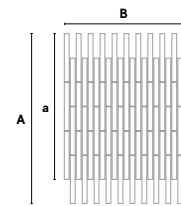

**A** 42,1 cm - 16<sup>5</sup>/<sub>8</sub>"  
**a** 36 cm - 14<sup>1</sup>/<sub>8</sub>"  
**B** 29,4 cm - 11<sup>5</sup>/<sub>8</sub>"

The decoration can only be laid on the wall - Il decoro si può posare solo a rivestimento - Décor uniquement mural - Das Dekor kann nur an der Wand verlegt werden  
La decoración se puede colocar únicamente en paredes - Декор может быть уложен только на стену.



© Ceramiche Atlas Concorde



© Ceramiche Atlas Concorde



© Ceramiche Atlas Concorde

INDEX



PRODUCT  
FINDER



SURFACE  
RANGE



COMPANY



COLLECTIONS



- 3D WALL
- CONCRETE & RESIN LOOK
- METAL LOOK
- MARBLE LOOK
- STONE LOOK
- WOOD LOOK

LARGE SIZES



TECHNICAL  
SPECIFICATIONS



# Blaze

## Wall Tiles

### MATTE SURFACE

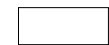

± 8,5 mm

50x120 cm - 19<sup>5</sup>/<sub>8</sub>"x47<sup>1</sup>/<sub>4</sub>"

A4R8 Blaze Aluminium

A4SB Blaze Iron

A4SA Blaze Corten

A4SC Blaze Verdigris



### TRIM TILES

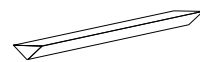

1,4x50 cm - 5<sup>5</sup>/<sub>8</sub>"x19<sup>5</sup>/<sub>8</sub>"

LB5M Blaze Aluminium Corner 50 \*

LB5C Blaze Corten Corner 50 \*

LB5R Blaze Iron Corner 50 \*

LB5V Blaze Verdigris Corner 50 \*

LB5S Blaze Iron Stripes Corner 50 \*



1,4x1,4 cm - 5<sup>5</sup>/<sub>8</sub>"x5<sup>5</sup>/<sub>8</sub>"

AØLA Blaze Aluminium Corner A.E. 1,4 \*

AØLC Blaze Corten Corner A.E. 1,4 \*

AØLR Blaze Iron Corner A.E. 1,4 \*

AØLV Blaze Verdigris Corner A.E. 1,4 \*

AØLS Blaze Iron Stripes Corner A.E. 1,4 \*

\* These parts are supplied to order - I pezzi sono disponibili su ordinazione - Les pièces sont disponibles sur commande - Die Teile sind auf Bestellung lieferbar - Las piezas se hacen por encargo - Изготавливаются на заказ  
Matte surface - Superficie matt - Surface Mat - Matte Oberfläche - Superficie Mate - Матовая поверхность

### DECOR RANGE



A4UC Blaze Aluminium Texture •  
50x120 cm - 19<sup>5</sup>/<sub>8</sub>"x47<sup>1</sup>/<sub>4</sub>"



A4UD Blaze Corten Texture •  
50x120 cm - 19<sup>5</sup>/<sub>8</sub>"x47<sup>1</sup>/<sub>4</sub>"

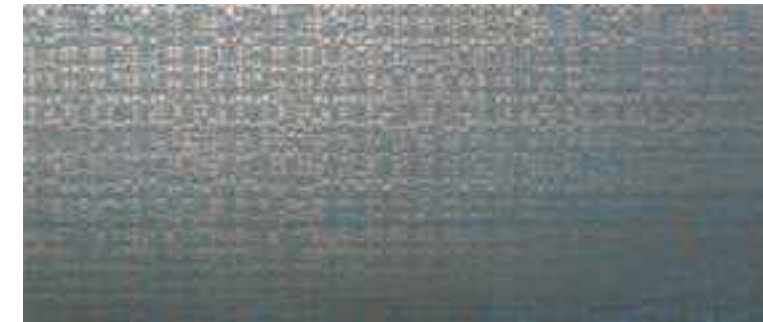

A4UE Blaze Verdigris Texture •  
50x120 cm - 19<sup>5</sup>/<sub>8</sub>"x47<sup>1</sup>/<sub>4</sub>"



A4SD Blaze Iron Stripes •  
50x120 cm - 19<sup>5</sup>/<sub>8</sub>"x47<sup>1</sup>/<sub>4</sub>"



9BNA Blaze Aluminium  
Mosaico Nest •  
29,4x25,8 - 11<sup>5</sup>/<sub>8</sub>"x10<sup>1</sup>/<sub>8</sub>"



9BNC Blaze Corten  
Mosaico Nest •  
29,4x25,8 - 11<sup>5</sup>/<sub>8</sub>"x10<sup>1</sup>/<sub>8</sub>"



9BNI Blaze Iron  
Mosaico Nest •  
29,4x25,8 - 11<sup>5</sup>/<sub>8</sub>"x10<sup>1</sup>/<sub>8</sub>"



9BNV Blaze Verdigris  
Mosaico Nest •  
29,4x25,8 - 11<sup>5</sup>/<sub>8</sub>"x10<sup>1</sup>/<sub>8</sub>"

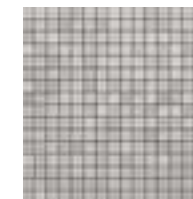
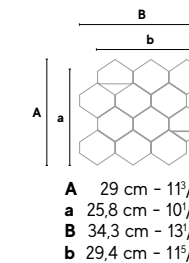

9BQA Blaze Aluminium  
Mos Q  
30,5x30,5 - 12"x12"



9BQC Blaze Corten  
Mos Q  
30,5x30,5 - 12"x12"

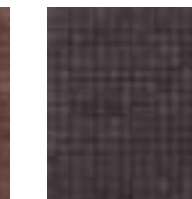

9BQI Blaze Iron  
Mos Q  
30,5x30,5 - 12"x12"

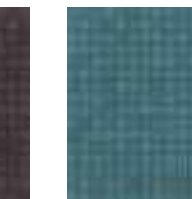

9BQV Blaze Verdigris  
Mos Q  
30,5x30,5 - 12"x12"



• Application of decorative materials. The use of a common mild detergent is recommended. Avoid using acidic or alkaline products, waxes, steel wool or abrasives. - Applicazione di materie decorative. Si consiglia l'utilizzo di un comune detergente neutro. Evitare l'utilizzo di prodotti acidi o alcalini, ceranti e pagliette di metallo o abrasive. - Application de matériaux décoratifs. Nous conseillons l'emploi de détergents neutres courants. Éviter l'utilisation de cires et de produits acides ou alcalins, ainsi que les pâilles métalliques ou abrasives. - Dekorationsmaterial. Es empfiehlt sich, ein haushaltsübliches, neutrales Reinigungsmittel zu verwenden. Saure oder alkalische Produkte, Wachs sowie Stahlwolle- bzw. Scheuerschwämme sind zu vermeiden. - Aplicación de materiales decorativos. Recomendamos utilizar un detergente neutro común. Hay que evitar el uso de productos ácidos o alcalinos, ceras y estropajos de metal o abrasivos. - Применение декоративных материалов. Рекомендуется чистить обычным нейтральным моющим средством. Не рекомендуется использовать кислотные, щелочные, восковые средства, а также металлические мочалки.

INDEX



PRODUCT  
FINDER



SURFACE  
RANGE



COMPANY



COLLECTIONS



3D WALL  
CONCRETE & RESIN LOOK

METAL LOOK

MARBLE LOOK

STONE LOOK

WOOD LOOK

LARGE SIZES



TECHNICAL  
SPECIFICATIONS





# Marvel

DOWNLOAD >  
CATALOG &  
IMAGE GALLERY

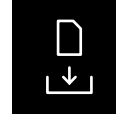

ENJOY THE  
VIDEO



© Ceramiche Atlas Concorde



© Ceramiche Atlas Concorde



© Ceramiche Atlas Concorde

## Porcelain Tiles

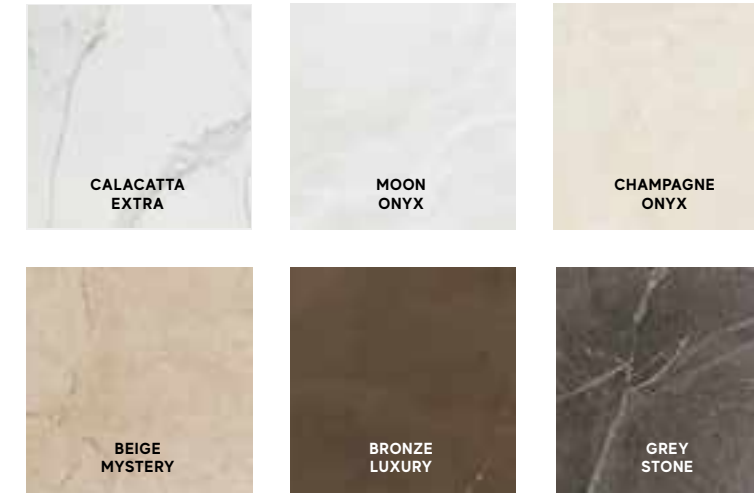

### COLOURED BODY PORCELAIN TILES - RECTIFIED MONOCALIBER

Sizes	Thickness	Surface finish
162x324 cm - 63 <sup>3</sup> / <sub>8</sub> "x127 <sup>1</sup> / <sub>2</sub> " NON RECTIFIED	± 6-12-20 mm	Polished   Silk
160x320 cm - 63"x126"	± 6 mm	Polished   Matte R9 A
160x160 cm - 63"x63"	± 6 mm	Polished   Matte R9 A
120x278 cm - 47 <sup>1</sup> / <sub>4</sub> "x109 <sup>1</sup> / <sub>2</sub> "	± 6 mm	Polished   Matte R9 A
120x240 cm - 47 <sup>1</sup> / <sub>4</sub> "x94 <sup>1</sup> / <sub>2</sub> "	± 9 mm	Polished
120x120 cm - 47 <sup>1</sup> / <sub>4</sub> "x47 <sup>1</sup> / <sub>4</sub> "	± 9 mm	Polished   Matte R9 A
60x120 cm - 23 <sup>3</sup> / <sub>8</sub> "x47 <sup>1</sup> / <sub>4</sub> "	± 9 mm	Polished   Matte R9 A
75x150 cm - 29 <sup>1</sup> / <sub>2</sub> "x59"	± 9 mm	Polished   Matte R9 A
75x75 cm - 29 <sup>1</sup> / <sub>2</sub> "x29 <sup>1</sup> / <sub>2</sub> "	± 9 mm	Polished   Matte R9 A
45x90 cm - 17 <sup>3</sup> / <sub>8</sub> "x35 <sup>3</sup> / <sub>8</sub> "	± 9 mm	Polished   Matte R9 A
60x60 cm - 23 <sup>3</sup> / <sub>8</sub> "x23 <sup>3</sup> / <sub>8</sub> "	± 9 mm	Polished   Matte R9 A
30x60 cm - 11 <sup>3</sup> / <sub>4</sub> "x23 <sup>3</sup> / <sub>8</sub> "	± 9 mm	Polished   Matte R9 A

LARGE SIZES p. 390

## Wall Tiles

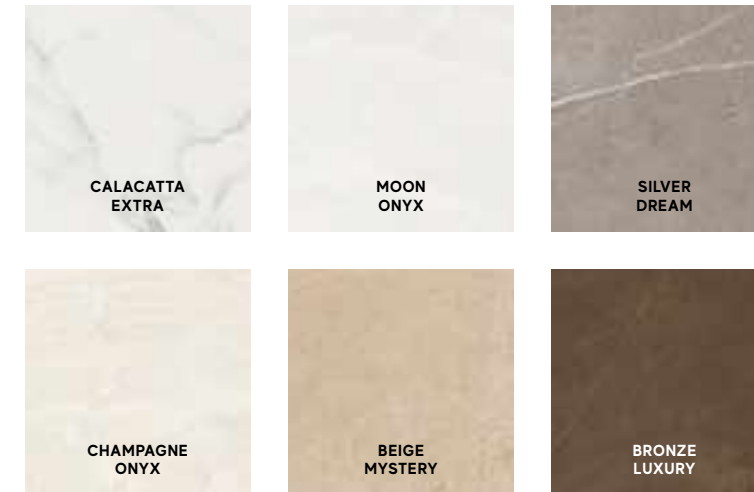

### WHITEBODY WALL TILES - RECTIFIED MONOCALIBER

Sizes	Thickness	Surface finish
50x120 cm - 19 <sup>5</sup> / <sub>8</sub> "x47 <sup>1</sup> / <sub>4</sub> "	± 8,5 mm	Shiny
40x80 cm - 15 <sup>3</sup> / <sub>4</sub> "x31 <sup>1</sup> / <sub>2</sub> "	± 8,5 mm	Shiny
30,5x91,5 cm - 12"x36"	± 8,5 mm	Shiny
30,5x56 cm - 12"x22"	± 8,5 mm	Shiny
8x31,5 cm - 3 <sup>1</sup> / <sub>8</sub> "x12 <sup>3</sup> / <sub>8</sub> "	± 8,5 mm	Shiny

Coloured body porcelain tiles – Gres porcellanato colorato in massa – Grès cérame coloré dans la masse – Durchgefärbtes Feinsteinzeug – Gres porcelánico coloreado en masa – Керамический гранит окрашенный в массе  
 Whitebody wall tiles – Rivestimenti in pasta bianca – Revêtements en pâte blanche – Weißscherbige Wandfliesen – Revestimientos en pasta blanca – Настенная плитка из белой глины  
 Rectified monocaliber – Rettificato monocalibro – Rectifié mono-calibre – Geschliffen einkalbrig – Rectificado monocalibre – Ретифицированный в одном калибре  
 Non rectified – Non rettificato – Non rectifié – Nicht rektifiziert – No rectificada – Неретифицированные

INDEX



PRODUCT  
FINDER



SURFACE  
RANGE



COMPANY



COLLECTIONS



- 3D WALL
- CONCRETE & RESIN LOOK
- METAL LOOK
- MARBLE LOOK
- STONE LOOK
- WOOD LOOK

LARGE SIZES



TECHNICAL  
SPECIFICATIONS



# Marvel

## Porcelain Tiles

### POLISHED SURFACE



± 6 mm  
**160x320 cm** - 63"x126"  
 AO5U Marvel Calacatta Extra Lapp



± 6 mm  
**160x160 cm** - 63"x63"  
 AO51 Marvel Calacatta Extra Lapp



± 6 mm  
**120x278 cm** - 47 1/4"x109 1/2"  
 AØBM Marvel Calacatta Extra Lapp  
 AOTJ Marvel Calacatta Extra Bookmatch A Lapp  
 AOTK Marvel Calacatta Extra Bookmatch B Lapp  
 AOQD Marvel Grey Stone Lapp  
 AOUB Marvel Calacatta Extra Endless Lapp  
 A6DU Marvel Calacatta Extra Lapp Kit Endless Lp



± 9 mm  
**120x240 cm** - 47 1/4"x94 1/2"  
 AY2N Marvel Calacatta Extra Lapp  
 AY2O Marvel Grey Stone Lapp

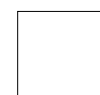

± 9 mm  
**120x120 cm** - 47 1/4"x47 1/4"  
 AY2R Marvel Calacatta Extra Lapp  
 AY2S Marvel Grey Stone Lapp



± 9 mm  
**60x120 cm** - 23 5/8"x47 1/4"  
 A21S Marvel Calacatta Extra Lapp  
 A21H Marvel Grey Stone Lapp



± 9 mm  
**75x150 cm** - 29 1/2"x59"  
 A61F Marvel Calacatta Extra Lapp  
 A7FN Marvel Grey Stone Lapp  
 A7FM Marvel Champagne Onyx Lapp



± 9 mm  
**75x75 cm** - 29 1/2"x29 1/2"  
 ADPV Marvel Calacatta Extra Lapp  
 ADPX Marvel Moon Onyx Lapp  
 ADPY Marvel Grey Stone Lapp  
 ADPW Marvel Champagne Onyx Lapp  
 ADPT Marvel Beige Mystery Lapp  
 ADPU Marvel Bronze Luxury Lapp



± 9 mm  
**45x90 cm** - 17 3/4"x35 3/8"  
 ADRS Marvel Calacatta Extra Lapp  
 AVWZ Marvel Moon Onyx Lapp  
 ADSY Marvel Grey Stone Lapp  
 AVWY Marvel Champagne Onyx Lapp  
 AVWW Marvel Beige Mystery Lapp  
 AVWX Marvel Bronze Luxury Lapp



± 9 mm  
**60x60 cm** - 23 5/8"x23 5/8"  
 7N3O Marvel Calacatta Extra Lapp  
 7N3P Marvel Moon Onyx Lapp  
 7N3T Marvel Grey Stone Lapp  
 7N3Q Marvel Champagne Onyx Lapp  
 7N3R Marvel Beige Mystery Lapp  
 7N3S Marvel Bronze Luxury Lapp



± 9 mm  
**30x60 cm** - 11 1/4"x23 5/8"  
 DØ16 Marvel Calacatta Extra Lapp  
 DØ17 Marvel Moon Onyx Lapp  
 DØ21 Marvel Grey Stone Lapp  
 DØ18 Marvel Champagne Onyx Lapp  
 DØ19 Marvel Beige Mystery Lapp  
 DØ2Ø Marvel Bronze Luxury Lapp



Polished ± 6 mm  
 Polished ± 9 mm



V2 Slight Variation



p. 390



**POLISHED**  
**162x324 cm** - 63 1/2"x127 1/2"  
 NON RECTIFIED



CALACATTA EXTRA



CHAMPAGNE ONYX



MOON ONYX



BEIGE MYSTERY

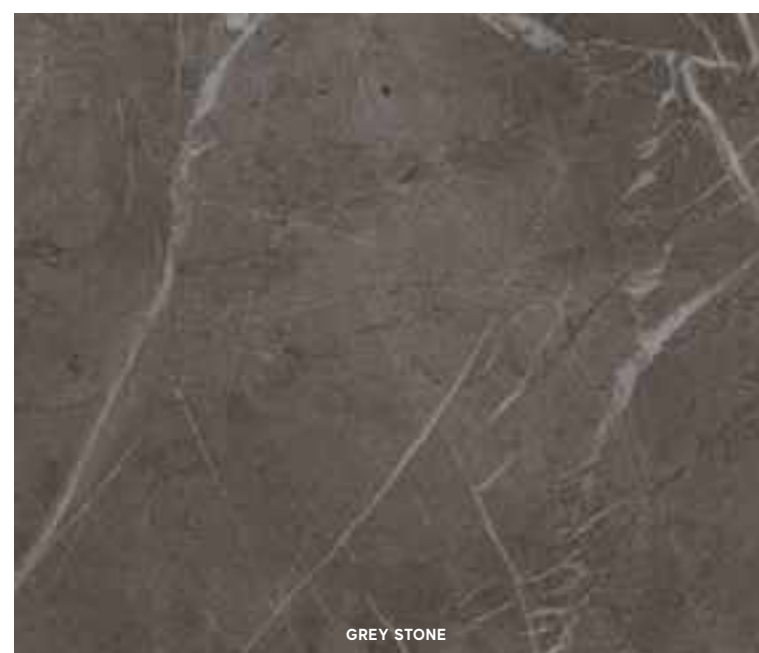

GREY STONE



BRONZE LUXURY

A polished finish is recommended for low-stress residential or commercial floors where anti-slip performance is not required. The surface's shine and superior ease of cleaning are the result of in-depth studies and extensive technical research aimed at ensuring its durability over time. If the product is in direct contact with the outside, use moisture and dirt absorption devices to prevent scratches. - La finitura lappata è indicata per pavimenti residenziali o commerciali poco sollecitati, laddove non siano richieste prestazioni antiscivolo. La lucentezza e l'elevata facilità di pulizia della superficie sono frutto di studi approfonditi e accurate ricerche tecniche volte a garantirne la persistenza nel tempo. Se il prodotto è a diretto contatto con l'esterno, prevedere dei dispositivi di assorbimento dell'umidità e dello sporco per prevenire la formazione di graffi. - La finition semi-polie est indiquée pour les sols résidentiels ou commerciaux à faibles contraintes, où la performance antidérapante n'est pas requise. La brillance et la grande facilité de nettoyage de la surface sont le résultat d'études approfondies et de recherches techniques précises visant à assurer sa persistance dans le temps. Si le produit est en contact direct avec l'extérieur, prévoyez des dispositifs d'absorption de l'humidité et des poussières pour éviter la formation de rayures. - Die Oberflächenversion Geläppt eignet sich für Bodenbeläge in Wohnbereichen bzw. in gering beanspruchten Gewerberäumen, wenn keine Rutschfestigkeit erforderlich ist. Der Glanz und die einfache Reinigung der Oberfläche sind das Resultat eingehender technischer Studien, mit denen die langfristige Beständigkeit sichergestellt wurde. Kommt das Produkt direkt mit der externen Umgebung in Kontakt, so sind Feuchtigkeit und Schmutz mit geeigneten Mitteln aufzunehmen, um Kratzer zu vermeiden. - El acabado lapeado es adecuado para pavimentos residenciales o comerciales con poco tráfico, donde no se requiere un efecto antideslizante. El brillo y la gran facilidad de limpieza de la superficie son el resultado de profundos estudios e investigaciones técnicas precisas para asegurar su persistencia en el tiempo. Si el producto está en contacto directo con el exterior, proporcionar dispositivos de absorción de humedad y suciedad para evitar arañazos. - Лаппатированная поверхность рекомендована для полов жилых и коммерческих помещений с невысокой интенсивностью эксплуатации, в которых от покрытий не требуется характеристик сопротивления скольжению. Блеск и легкая очищаемость являются результатом глубоких исследований, направленных на создание долговечного материала. Если плитка находится в непосредственном контакте с наружной средой, необходимо предусмотреть устройства поглощения влаги и грязи во избежание образования царапин.

Polished surface - Superficie lappata - Surface adouci - Geläppte Oberfläche - Superficie brulido - Полуполированный поверхность

INDEX



PRODUCT FINDER



SURFACE RANGE



COMPANY



COLLECTIONS



- 3D WALL
- CONCRETE & RESIN LOOK
- METAL LOOK
- MARBLE LOOK
- STONE LOOK
- WOOD LOOK

LARGE SIZES



TECHNICAL SPECIFICATIONS



# Marvel

## Porcelain Tiles



### MATTE SURFACE

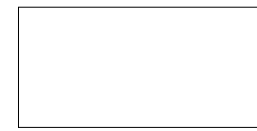

± 6 mm  
160x320 cm - 63"x126"  
A05Y Marvel Calacatta Extra Matt



± 6 mm  
160x160 cm - 63"x63"  
A054 Marvel Calacatta Extra Matt

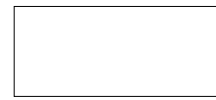

± 6 mm  
120x278 cm - 47 1/4"x109 1/2"  
A0BT Marvel Calacatta Extra Matt  
A2RP Marvel Grey Stone Matt



atlasPLAN  
p. 390  
SILK  
162x324 cm - 63 3/4"x127 1/2"  
NON RECTIFIED



± 9 mm  
120x120 cm - 47 1/4"x47 1/4"  
A2ØY Marvel Calacatta Extra Matt  
AEQY Marvel Grey Stone Matt



± 9 mm  
60x120 cm - 23 5/8"x47 1/4"  
A2Ø8 Marvel Calacatta Extra Matt  
A2Ø9 Marvel Grey Stone Matt



± 9 mm  
60x60 cm - 23 5/8"x23 5/8"  
7N3A Marvel Calacatta Extra Matt  
7N3B Marvel Moon Onyx Matt  
7N3F Marvel Grey Stone Matt  
7N3C Marvel Champagne Onyx Matt  
7N3D Marvel Beige Mystery Matt  
7N3E Marvel Bronze Luxury Matt



± 9 mm  
30x60 cm - 11 3/4"x23 5/8"  
DØ95 Marvel Calacatta Extra Matt  
DØ96 Marvel Moon Onyx Matt  
D1ØØ Marvel Grey Stone Matt  
DØ97 Marvel Champagne Onyx Matt  
DØ98 Marvel Beige Mystery Matt  
DØ99 Marvel Bronze Luxury Matt



± 9 mm  
75x150 cm - 29 1/2"x59"  
A7HX Marvel Calacatta Extra Matt



± 9 mm  
75x75 cm - 29 1/2"x29 1/2"  
ASCE Marvel Calacatta Extra Matt  
ASCF Marvel Moon Onyx Matt  
ASCJ Marvel Grey Stone Matt  
ASCG Marvel Champagne Onyx Matt  
ASCH Marvel Beige Mystery Matt  
ASCI Marvel Bronze Luxury Matt



± 9 mm  
45x90 cm - 17 3/4"x35 3/8"  
ASFE Marvel Calacatta Extra Matt  
ASFG Marvel Moon Onyx Matt  
ASFJ Marvel Grey Stone Matt  
ASFF Marvel Champagne Onyx Matt  
ASFH Marvel Beige Mystery Matt  
ASFI Marvel Bronze Luxury Matt

### TRIM TILES

p. 462  
UPEC  
p. 455

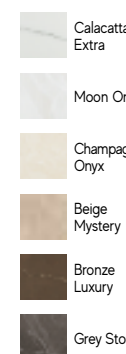

#### Battiscopa

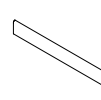

7,2x60 cm  
2 7/8"x23 5/8"

Matt Lapp

ASLJ	AVXS
ASLK	AVXT
ASLL	AVXU
ASLM	AVXV
ASLN	AVXW
ASLO	AVXX

#### Gradino \*

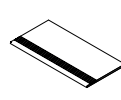

30x60 cm  
11 1/4"x23 5/8"

Matt

ASLQ
ASLR
ASLS
ASLT
ASLU
ASLV

#### Scalino \*

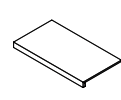

33x75 cm  
13"x29 1/2"

Matt

ASMH	ASMZ
ASMI	ASMØ
ASMJ	ASM1
ASMK	ASM2
ASML	ASM5
ASMM	ASM7

#### Scalin Ang.\*

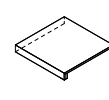

33x60 cm  
13"x23 5/8"

Matt

ASMT	ASMU	ASMV	ASMW	ASMX
ASMN	ASMO	ASMP	ASMQ	ASMR
ASMY				

#### Battiscopa Sag. Scala \*



7,2x30 cm  
2 7/8"x11 1/4"

Matt

DX	SX
ASNC	ASNI
ASND	ASNU
ASNE	ASNK
ASNF	ASNL
ASNG	ASNM
ASNH	ASNN

\* These parts are supplied to order - I pezzi sono disponibili su ordinazione - Les pièces sont disponibles sur commande - Die Teile sind auf Bestellung lieferbar - Las piezas se hacen por encargo - Изготавливаются на заказ

Matte surface - Superficie matt - Surface Mat - Matte Oberfläche - Superficie Mate - Матовая поверхность



CALACATTA EXTRA



CHAMPAGNE ONYX



MOON ONYX



BEIGE MYSTERY



GREY STONE



BRONZE LUXURY

INDEX



PRODUCT  
FINDER



SURFACE  
RANGE



COMPANY



COLLECTIONS



- 3D WALL
- CONCRETE & RESIN LOOK
- METAL LOOK
- MARBLE LOOK
- STONE LOOK
- WOOD LOOK

LARGE SIZES



TECHNICAL  
SPECIFICATIONS



# Marvel

## Porcelain Tiles

### DECOR RANGE



ASLC Marvel Calacatta Mosaico 3D ▲  
30x30 - 1 1/4" x 1 1/4"

ASLD Marvel Moon Mosaico 3D ▲  
30x30 - 1 1/4" x 1 1/4"

ASLH Marvel Grey Mosaico 3D ▲  
30x30 - 1 1/4" x 1 1/4"

ASLE Marvel Champagne Mosaico 3D ▲  
30x30 - 1 1/4" x 1 1/4"

ASLF Marvel Beige Mosaico 3D ▲  
30x30 - 1 1/4" x 1 1/4"

ASLG Marvel Bronze Mosaico 3D ▲  
30x30 - 1 1/4" x 1 1/4"

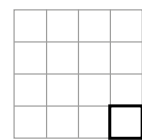

7,4x7,4 cm  
2 7/8" x 2 7/8"



ASK5 Marvel Calacatta Mosaico Matt  
30x30 - 1 1/4" x 1 1/4"

ASK6 Marvel Moon Mosaico Matt  
30x30 - 1 1/4" x 1 1/4"

ASLA Marvel Grey Mosaico Matt  
30x30 - 1 1/4" x 1 1/4"

ASK7 Marvel Champagne Mosaico Matt  
30x30 - 1 1/4" x 1 1/4"

ASK8 Marvel Beige Mosaico Matt  
30x30 - 1 1/4" x 1 1/4"

ASK9 Marvel Bronze Mosaico Matt  
30x30 - 1 1/4" x 1 1/4"

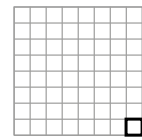

3,5x3,5 cm  
1 3/8" x 1 3/8"



ASMB Marvel Calacatta Mosaico Lapp  
30x30 - 1 1/4" x 1 1/4"

ASMC Marvel Moon Mosaico Lapp  
30x30 - 1 1/4" x 1 1/4"

ASMG Marvel Grey Mosaico Lapp  
30x30 - 1 1/4" x 1 1/4"

ASMD Marvel Champagne Mosaico Lapp  
30x30 - 1 1/4" x 1 1/4"

ASME Marvel Beige Mosaico Lapp  
30x30 - 1 1/4" x 1 1/4"

ASMF Marvel Bronze Mosaico Lapp  
30x30 - 1 1/4" x 1 1/4"

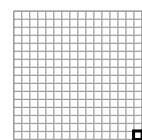

1,7x1,7 cm  
5/8" x 5/8"



ASM9 Marvel Grey/Moon Greca Mosaico  
18,5x30 - 7 1/4" x 1 1/4"

ASNB Marvel Grey/Moon Angolo Mosaico  
18,5x18,5 - 7 1/4" x 7 1/4"



ASM8 Marvel Bronze/Champagne Greca Mosaico  
18,5x30 - 7 1/4" x 1 1/4"

ASNA Marvel Bronze/Champagne Angolo Mosaico  
18,5x18,5 - 7 1/4" x 7 1/4"



1,7x1,7 cm  
5/8" x 5/8"

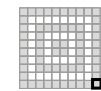

1,7x1,7 cm  
5/8" x 5/8"

▲ Multi-thickness mosaic, close joint installation without grouting. - Mosaico multispessore, posa senza stuccatura a giunto unito. - Mosaïque multi-épaisseur, pose sans mastic avec joint nul. - Mosaik mit verschiedenen Stärken, fugenlose Verlegung ohne Mörtel. - Mosaico multiespesor, colocación sin mástico y sin juntas. - Мозаика разной толщины, укладка встык без затирки швов.

■ The decoration can only be laid on the wall. - Il decoro si può posare solo a rivestimento. - Décor uniquement mural. - Das Dekor kann nur an der Wand verlegt werden. - La decoración se puede colocar únicamente en paredes. - Декор может быть уложен только на стену.



AVXF Marvel Calacatta Listello Lapp  
7x75 - 2 3/4" x 29 1/2"



AVXG Marvel Moon Listello Lapp  
7x75 - 2 3/4" x 29 1/2"



AVXK Marvel Grey Listello Lapp  
7x75 - 2 3/4" x 29 1/2"



AVXH Marvel Champagne Listello Lapp  
7x75 - 2 3/4" x 29 1/2"



AVXJ Marvel Beige Listello Lapp  
7x75 - 2 3/4" x 29 1/2"



AVXI Marvel Bronze Listello Lapp  
7x75 - 2 3/4" x 29 1/2"



AVXL Marvel Calacatta Listello Esagono Lapp  
11x86 - 4 3/8" x 33 7/8"



AVXN Marvel Moon Listello Esagono Lapp  
11x86 - 4 3/8" x 33 7/8"

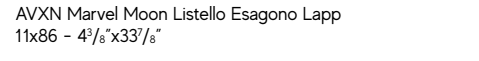

AVXQ Marvel Grey Listello Esagono Lapp  
11x86 - 4 3/8" x 33 7/8"



AVXP Marvel Bronze Listello Esagono Lapp  
11x86 - 4 3/8" x 33 7/8"



AD5Q Etic Rovere Listello Esagono  
11x86 - 4 3/8" x 33 7/8"

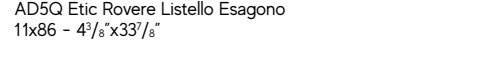

AD5R Etic Noce Listello Esagono  
11x86 - 4 3/8" x 33 7/8"

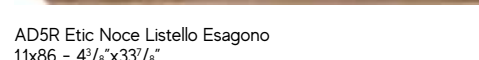

AD5S Etic Ebano Listello Esagono  
11x86 - 4 3/8" x 33 7/8"

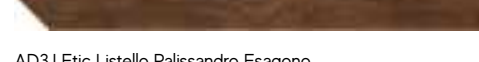

AD3J Etic Listello Palissandro Esagono  
11x86 - 4 3/8" x 33 7/8"



AVXB Marvel Calacatta Listello Lapp  
7x60 - 2 3/4" x 23 5/8"



AVXC Marvel Moon Listello Lapp  
7x60 - 2 3/4" x 23 5/8"



AVXE Marvel Grey Listello Lapp  
7x60 - 2 3/4" x 23 5/8"



AE3W Marvel Champagne Listello Lapp  
7x60 - 2 3/4" x 23 5/8"



AVXD Marvel Beige Listello Lapp  
7x60 - 2 3/4" x 23 5/8"



AE3X Marvel Bronze Listello Lapp  
7x60 - 2 3/4" x 23 5/8"



AVXM Marvel Champagne Listello Esagono Lapp  
11x86 - 4 3/8" x 33 7/8"



AVXO Marvel Beige Listello Esagono Lapp  
11x86 - 4 3/8" x 33 7/8"



AVXP Marvel Bronze Listello Esagono Lapp  
11x86 - 4 3/8" x 33 7/8"

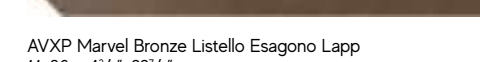

AD5P Etic Rovere Bianco Listello Esagono  
11x86 - 4 3/8" x 33 7/8"

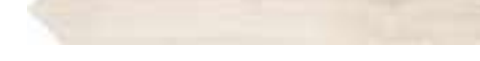

AD5S Etic Ebano Listello Esagono  
11x86 - 4 3/8" x 33 7/8"



AD5S Etic Ebano Listello Esagono  
11x86 - 4 3/8" x 33 7/8"



AD5S Etic Ebano Listello Esagono  
11x86 - 4 3/8" x 33 7/8"

INDEX



PRODUCT  
FINDER



SURFACE  
RANGE



COMPANY



COLLECTIONS



- 3D WALL
- CONCRETE & RESIN LOOK
- METAL LOOK
- MARBLE LOOK
- STONE LOOK
- WOOD LOOK

LARGE SIZES



TECHNICAL  
SPECIFICATIONS



# Marvel

## Porcelain Tiles

### DECOR RANGE



ASL5 Marvel Calacatta Cassettone Lapp  
45x45 - 17<sup>3</sup>/<sub>4</sub>"x17<sup>3</sup>/<sub>4</sub>"

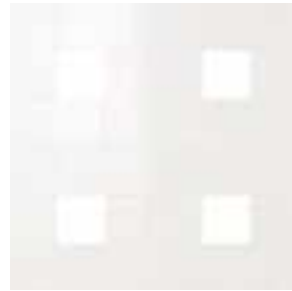

ASL6 Marvel Moon Cassettone Lapp  
45x45 - 17<sup>3</sup>/<sub>4</sub>"x17<sup>3</sup>/<sub>4</sub>"

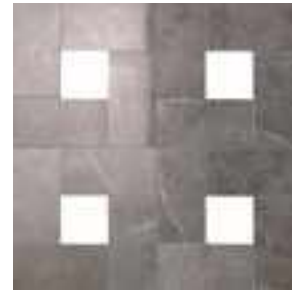

ASMA Marvel Grey Cassettone Lapp  
45x45 - 17<sup>3</sup>/<sub>4</sub>"x17<sup>3</sup>/<sub>4</sub>"

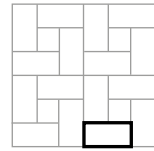

14,5x7,4 cm  
5<sup>3</sup>/<sub>4</sub>"x2<sup>3</sup>/<sub>8</sub>"



ASL7 Marvel Champagne Cassettone Lapp  
45x45 - 17<sup>3</sup>/<sub>4</sub>"x17<sup>3</sup>/<sub>4</sub>"



ASL8 Marvel Beige Cassettone Lapp  
45x45 - 17<sup>3</sup>/<sub>4</sub>"x17<sup>3</sup>/<sub>4</sub>"



ASL9 Marvel Bronze Cassettone Lapp  
45x45 - 17<sup>3</sup>/<sub>4</sub>"x17<sup>3</sup>/<sub>4</sub>"



ASJ3 Marvel Calacatta  
Angolo Lapp  
7x7 - 2<sup>3</sup>/<sub>4</sub>"x2<sup>3</sup>/<sub>4</sub>"



ASJ4 Marvel Moon  
Angolo Lapp  
7x7 - 2<sup>3</sup>/<sub>4</sub>"x2<sup>3</sup>/<sub>4</sub>"



ASJ8 Marvel Grey  
Angolo Lapp  
7x7 - 2<sup>3</sup>/<sub>4</sub>"x2<sup>3</sup>/<sub>4</sub>"



ASJ5 Marvel Champagne  
Angolo Lapp  
7x7 - 2<sup>3</sup>/<sub>4</sub>"x2<sup>3</sup>/<sub>4</sub>"



ASJ6 Marvel Beige  
Angolo Lapp  
7x7 - 2<sup>3</sup>/<sub>4</sub>"x2<sup>3</sup>/<sub>4</sub>"



ASJ7 Marvel Bronze  
Angolo Lapp  
7x7 - 2<sup>3</sup>/<sub>4</sub>"x2<sup>3</sup>/<sub>4</sub>"



ADQ2 Marvel Statuario  
Select Angolo Lapp  
7x7 - 2<sup>3</sup>/<sub>4</sub>"x2<sup>3</sup>/<sub>4</sub>"



ADQ6 Marvel Grey Fleury  
Angolo Lapp  
7x7 - 2<sup>3</sup>/<sub>4</sub>"x2<sup>3</sup>/<sub>4</sub>"



ADQ7 Marvel Noir St.  
Laurent Angolo Lapp  
7x7 - 2<sup>3</sup>/<sub>4</sub>"x2<sup>3</sup>/<sub>4</sub>"



ADQ4 Marvel Crema  
Delicato Angolo Lapp  
7x7 - 2<sup>3</sup>/<sub>4</sub>"x2<sup>3</sup>/<sub>4</sub>"



ADQ3 Marvel Travertino  
Alabastrino Angolo Lapp  
7x7 - 2<sup>3</sup>/<sub>4</sub>"x2<sup>3</sup>/<sub>4</sub>"



ADQ5 Marvel Travertino  
Silver Angolo Lapp  
7x7 - 2<sup>3</sup>/<sub>4</sub>"x2<sup>3</sup>/<sub>4</sub>"



AM8R Etic Rovere  
Bottone  
7x7 - 2<sup>3</sup>/<sub>4</sub>"x2<sup>3</sup>/<sub>4</sub>"



AM8T Etic Noce  
Bottone  
7x7 - 2<sup>3</sup>/<sub>4</sub>"x2<sup>3</sup>/<sub>4</sub>"



AM8V Etic Palissandro  
Bottone  
7x7 - 2<sup>3</sup>/<sub>4</sub>"x2<sup>3</sup>/<sub>4</sub>"



AM8Q Etic Rovere  
Bianco Bottone  
7x7 - 2<sup>3</sup>/<sub>4</sub>"x2<sup>3</sup>/<sub>4</sub>"



AM8U Etic Rovere  
Grigio Bottone  
7x7 - 2<sup>3</sup>/<sub>4</sub>"x2<sup>3</sup>/<sub>4</sub>"



AVW4 Marvel Elegance Angolo Warm ▲  
60x60 - 23<sup>3</sup>/<sub>8</sub>"x23<sup>3</sup>/<sub>8</sub>"



AVW6 Marvel Elegance Fascia Warm  
60x60 - 23<sup>3</sup>/<sub>8</sub>"x23<sup>3</sup>/<sub>8</sub>"



AVW3 Marvel Elegance Angolo Cold ▲  
60x60 - 23<sup>3</sup>/<sub>8</sub>"x23<sup>3</sup>/<sub>8</sub>"



AVW5 Marvel Elegance Fascia Cold  
60x60 - 23<sup>3</sup>/<sub>8</sub>"x23<sup>3</sup>/<sub>8</sub>"



AVW7 Marvel Glitter Rosone Angolo ▲▲  
60x60 - 23<sup>3</sup>/<sub>8</sub>"x23<sup>3</sup>/<sub>8</sub>"



AVW8 Marvel Glitter Fascia  
7x60 - 2<sup>3</sup>/<sub>4</sub>"x23<sup>3</sup>/<sub>8</sub>"



ASNQ Marvel Glitter Bottone  
7x7 - 2<sup>3</sup>/<sub>4</sub>"x2<sup>3</sup>/<sub>4</sub>"

INDEX



PRODUCT  
FINDER



SURFACE  
RANGE



COMPANY



COLLECTIONS



- 3D WALL
- CONCRETE & RESIN LOOK
- METAL LOOK
- MARBLE LOOK
- STONE LOOK
- WOOD LOOK

LARGE SIZES



TECHNICAL  
SPECIFICATIONS



▲ Minimum order 2 pieces. - Ordine minimo 2 pezzi. - Commande minimum 2 pièces. - Mindestbestellmenge 2 Stück. - Pedido mínimo 2 unidades. - Минимальный заказ - 2 шт.  
▲▲ Minimum order 4 pieces. - Ordine minimo 4 pezzi. - Commande minimum 4 pièces. - Mindestbestellmenge 4 Stück. - Pedido mínimo 4 unidades. - Минимальный заказ - 4 шт.

# Marvel

## Wall Tiles

### SHINY SURFACE



± 8,5 mm

**50x120 cm** - 19<sup>5</sup>/<sub>8</sub>"x47<sup>1</sup>/<sub>4</sub>"  
A4ST Marvel Calacatta Extra



± 8,5 mm

**40x80 cm** - 15<sup>3</sup>/<sub>4</sub>"x31<sup>1</sup>/<sub>2</sub>"  
8MVA Marvel Calacatta Extra  
8MVC Marvel Champagne Onyx  
8MVS Marvel Silver Dream

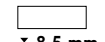

± 8,5 mm

**30,5x91,5 cm** - 12"x36"  
AR5J Marvel Calacatta Extra  
AR5L Marvel Moon Onyx  
AR5N Marvel Silver Dream  
AR5K Marvel Champagne Onyx  
AR5M Marvel Beige Mystery  
AR5O Marvel Bronze Luxury

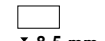

± 8,5 mm

**30,5x56 cm** - 12"x22"  
9P5L Marvel Calacatta Extra  
9P5M Marvel Moon Onyx  
9P5S Marvel Silver Dream  
9P5H Marvel Champagne Onyx  
9P5E Marvel Beige Mystery  
9P5O Marvel Bronze Luxury

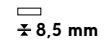

± 8,5 mm

**8x31,5 cm** - 3<sup>1</sup>/<sub>8</sub>"x12<sup>3</sup>/<sub>8</sub>"  
LMKC Calacatta Extra Brick



CALACATTA EXTRA



CHAMPAGNE ONYX



MOON ONYX



BEIGE MYSTERY



SILVER DREAM



BRONZE LUXURY

### TRIM TILES



ASDZ Marvel Calacatta London  
5x30,5 - 2"x12"



ASD7 Marvel London A.E.  
5x2,5 - 2"x1"



ASD1 Marvel Moon London  
5x30,5 - 2"x12"



ASD9 Marvel London A.E.  
5x2,5 - 2"x1"



ASD4 Marvel Silver London  
5x30,5 - 2"x12"



ASEC Marvel London A.E.  
5x2,5 - 2"x1"

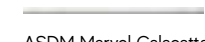

ASDM Marvel Calacatta Spigolo  
0,85x30,5 - 3<sup>3</sup>/<sub>8</sub>"x12"



ASEE Marvel Spigolo A.E.  
0,85x0,85 - 3<sup>3</sup>/<sub>8</sub>"x7<sup>1</sup>/<sub>8</sub>"

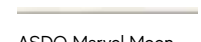

ASDO Marvel Moon Spigolo  
0,85x30,5 - 3<sup>3</sup>/<sub>8</sub>"x12"



ASEG Marvel Spigolo A.E.  
0,85x0,85 - 3<sup>3</sup>/<sub>8</sub>"x7<sup>1</sup>/<sub>8</sub>"



ASDQ Marvel Silver Spigolo  
0,85x30,5 - 3<sup>3</sup>/<sub>8</sub>"x12"



ASEI Marvel Spigolo A.E.  
0,85x0,85 - 3<sup>3</sup>/<sub>8</sub>"x7<sup>1</sup>/<sub>8</sub>"



ASDG Marvel Calacatta Alzata  
20x30,5 - 7<sup>7</sup>/<sub>8</sub>"x12"



ASDT Marvel Alzata A.E.  
1,5x20 - 5<sup>5</sup>/<sub>8</sub>"x7<sup>1</sup>/<sub>8</sub>"



ASDH Marvel Moon Alzata  
20x30,5 - 7<sup>7</sup>/<sub>8</sub>"x12"



ASDV Marvel Alzata A.E.  
1,5x20 - 5<sup>5</sup>/<sub>8</sub>"x7<sup>1</sup>/<sub>8</sub>"



ASDK Marvel Silver Alzata  
20x30,5 - 7<sup>7</sup>/<sub>8</sub>"x12"



ASDX Marvel Alzata A.E.  
1,5x20 - 5<sup>5</sup>/<sub>8</sub>"x7<sup>1</sup>/<sub>8</sub>"



ASDØ Marvel Champagne London  
5x30,5 - 2"x12"



ASD8 Marvel London A.E.  
5x2,5 - 2"x1"



ASD3 Marvel Beige London  
5x30,5 - 2"x12"



ASEA Marvel London A.E.  
5x2,5 - 2"x1"



ASD5 Marvel Bronze London  
5x30,5 - 2"x12"



ASED Marvel London A.E.  
5x2,5 - 2"x1"

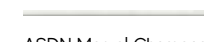

ASDN Marvel Champagne Spigolo  
0,85x30,5 - 3<sup>3</sup>/<sub>8</sub>"x12"



ASEF Marvel Spigolo A.E.  
0,85x0,85 - 3<sup>3</sup>/<sub>8</sub>"x7<sup>1</sup>/<sub>8</sub>"



ASDP Marvel Beige Spigolo  
0,85x30,5 - 3<sup>3</sup>/<sub>8</sub>"x12"



ASEH Marvel Spigolo A.E.  
0,85x0,85 - 3<sup>3</sup>/<sub>8</sub>"x7<sup>1</sup>/<sub>8</sub>"



ASDR Marvel Bronze Spigolo  
0,85x30,5 - 3<sup>3</sup>/<sub>8</sub>"x12"



ASEJ Marvel Spigolo A.E.  
0,85x0,85 - 3<sup>3</sup>/<sub>8</sub>"x7<sup>1</sup>/<sub>8</sub>"



ASDF Marvel Champagne Alzata  
20x30,5 - 7<sup>7</sup>/<sub>8</sub>"x12"



ASDU Marvel Alzata A.E.  
1,5x20 - 5<sup>5</sup>/<sub>8</sub>"x7<sup>1</sup>/<sub>8</sub>"



ASDJ Marvel Beige Alzata  
20x30,5 - 7<sup>7</sup>/<sub>8</sub>"x12"



ASDW Marvel Alzata A.E.  
1,5x20 - 5<sup>5</sup>/<sub>8</sub>"x7<sup>1</sup>/<sub>8</sub>"



ASDL Marvel Bronze Alzata  
20x30,5 - 7<sup>7</sup>/<sub>8</sub>"x12"



ASDY Marvel Alzata A.E.  
1,5x20 - 5<sup>5</sup>/<sub>8</sub>"x7<sup>1</sup>/<sub>8</sub>"

INDEX



PRODUCT FINDER



SURFACE RANGE



COMPANY



COLLECTIONS



- 3D WALL
- CONCRETE & RESIN LOOK
- METAL LOOK
- MARBLE LOOK
- STONE LOOK
- WOOD LOOK

LARGE SIZES



TECHNICAL SPECIFICATIONS



# Marvel

## Wall Tiles

### DECOR RANGE



ASCC Marvel Moon Line  
30,5x91,5 - 12"x36"



ASCA Marvel Champagne Line  
30,5x91,5 - 12"x36"



ASEN Marvel Champagne Wave  
30,5x91,5 - 12"x36"



ASCZ Marvel Beige Brocade  
30,5x91,5 - 12"x36"



ASCY Marvel Bronze Brocade  
30,5x91,5 - 12"x36"



ASCD Marvel Bronze Wallpaper  
30,5x91,5 - 12"x36"



ASDC Marvel Calacatta Terminale Lesena  
10x20 - 3 7/8"x7 1/8"



ASC9 Marvel Champagne Terminale Lesena  
10x20 - 3 7/8"x7 1/8"



ASC6 Marvel Calacatta Lesena  
30,5x20 - 12"x7 1/8"



ASC5 Marvel Champagne Lesena  
30,5x20 - 12"x7 1/8"



ASC8 Marvel Calacatta Base Lesena  
20x20 - 7 1/8"x7 1/8"



ASC7 Marvel Champagne Base Lesena  
20x20 - 7 1/8"x7 1/8"



ASDE Marvel Calacatta Fregio  
10x30,5 - 3 7/8" x12"



ASDD Marvel Champagne Fregio  
10x30,5 - 3 7/8" x12"



ASEK Marvel Greca Gold ●  
7,8x30,5 - 3 1/8"x12"



ASEM Marvel Greca A.E. ●  
7,8x12 - 3 1/8"x1 1/2"

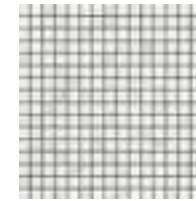

ASCM Marvel Calacatta Mosaic ▲  
30,5x30,5 - 12"x12"

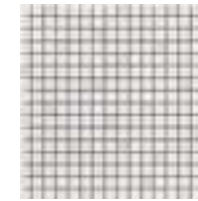

ASCO Marvel Moon Mosaic ▲  
30,5x30,5 - 12"x12"

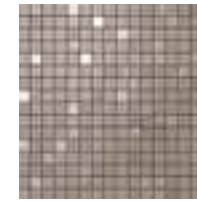

ASCR Marvel Silver Mosaic ▲  
30,5x30,5 - 12"x12"



ASCS Marvel Bronze Mosaic ▲  
30,5x30,5 - 12"x12"



ASCT Marvel Bronze Gold Mosaic ▲●  
30,5x30,5 - 12"x12"

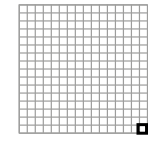

1,7x1,7 cm  
5/8"x5/8"

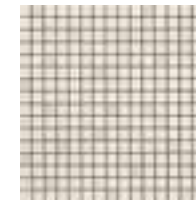

ASCN Marvel Champagne Mosaic ▲  
30,5x30,5 - 12"x12"



ASCQ Marvel Beige Mosaic ▲  
30,5x30,5 - 12"x12"



ASCV Marvel Silver Net Mosaic ▲  
30,5x30,5 - 12"x12"



ASCX Marvel Beige Net Mosaic ▲  
30,5x30,5 - 12"x12"



ASCW Marvel Bronze Net Mosaic ▲  
30,5x30,5 - 12"x12"

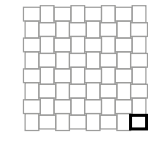

3,3x3,9 cm  
1 1/4"x1 1/2"



ASC1 Marvel Moon Damask ◆  
30,5x56 - 12"x22"



ASCØ Marvel Champagne Damask  
30,5x56 - 12"x22"



ASC4 Marvel Silver Stripe  
30,5x56 - 12"x22"



ASC3 Marvel Beige Stripe  
30,5x56 - 12"x22"

● **Also matching with Calacatta Extra.** - Abbinabile anche al Calacatta Extra. - Combinable également avec Calacatta Extra. - Kombinierbar auch mit Calacatta Extra. - Combinable también con Calacatta Extra. - Сочетается также с Calacatta Extra.  
▲ **Matching with both sizes 30.5x91.5 and 30.5x56.** - Abbinabili a entrambi i formati 30,5x91,5 e 30,5x56. - Combinables avec les deux formats 30,5x91,5 et 30,5x56. - Kombinierbar mit den beiden Formaten 30,5x91,5 und 30,5x56. - Combinables con ambos formatos 30,5x91,5 y 30,5x56. - Сочетается с обоими форматами: 30,5x91,5 и 30,5x56.  
◆ **Decor with gold insert** - Decoro con inserto in oro - Décor avec insert en or - Dekor mit Goldeinlage - Decoración con aplicación de oro - Декор с золотой вставкой  
◆ **Shiny surface** - Superficie lucida - Surface brillante - Glänzende Oberfläche - Superficie brillante - Глянцевая поверхность

INDEX



PRODUCT FINDER



SURFACE RANGE



COMPANY



COLLECTIONS



- 3D WALL
- CONCRETE & RESIN LOOK
- METAL LOOK
- MARBLE LOOK
- STONE LOOK
- WOOD LOOK

LARGE SIZES



TECHNICAL SPECIFICATIONS



# Marvel Dream

DOWNLOAD >  
CATALOG &  
IMAGE GALLERY

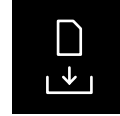

ENJOY THE  
VIDEO

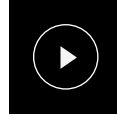

© Ceramiche Atlas Concorde



© Ceramiche Atlas Concorde



© Ceramiche Atlas Concorde

## Porcelain Tiles

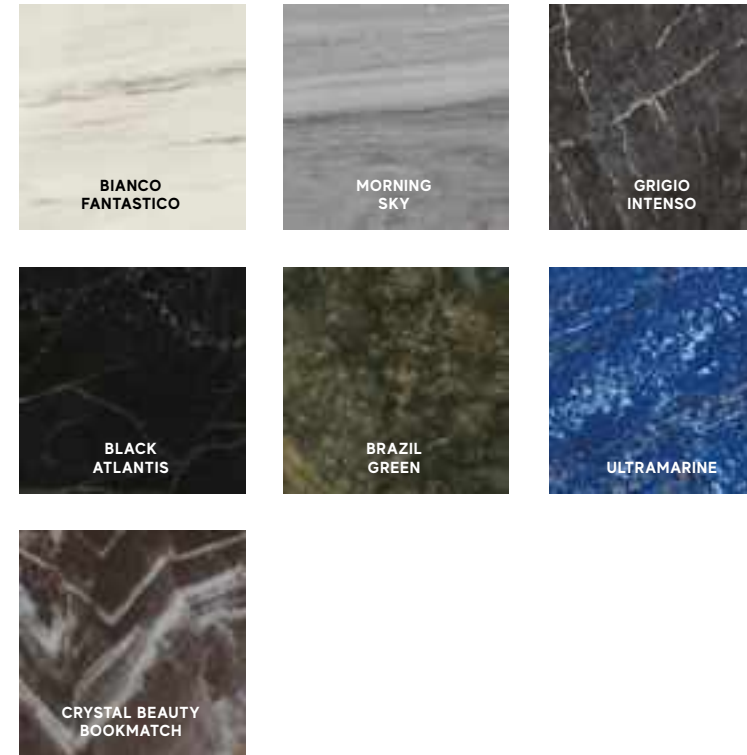

### COLOURED BODY PORCELAIN TILES - RECTIFIED MONOCALIBER

Sizes	Thickness	Surface finish
162x324 cm - 63 <sup>3</sup> / <sub>4</sub> "x127 <sup>1</sup> / <sub>2</sub> " NON RECTIFIED	± 6-12 mm	Polished I Silk
120x278 cm - 47 <sup>1</sup> / <sub>4</sub> "x109 <sup>1</sup> / <sub>2</sub> "	± 6 mm	Polished I Matte R9 A
120x240 cm - 47 <sup>1</sup> / <sub>4</sub> "x94 <sup>1</sup> / <sub>2</sub> "	± 9 mm	Polished
120x120 cm - 47 <sup>1</sup> / <sub>4</sub> "x47 <sup>1</sup> / <sub>4</sub> "	± 9 mm	Polished I Matte R9 A
60x120 cm - 23 <sup>5</sup> / <sub>8</sub> "x47 <sup>1</sup> / <sub>4</sub> "	± 9 mm	Polished I Matte R9 A
75x150 cm - 29 <sup>1</sup> / <sub>2</sub> "x59"	± 9 mm	Polished I Matte R9 A
75x75 cm - 29 <sup>1</sup> / <sub>2</sub> "x29 <sup>1</sup> / <sub>2</sub> "	± 9 mm	Polished I Matte R9 A
37,5x75 cm - 14 <sup>3</sup> / <sub>8</sub> "x29 <sup>1</sup> / <sub>2</sub> "	± 9 mm	Polished I Matte R9 A
60x60 cm - 23 <sup>5</sup> / <sub>8</sub> "x23 <sup>5</sup> / <sub>8</sub> "	± 9 mm	Polished I Matte R10 A+B SOFT TOUCH **

LARGE SIZES p. 390

## Wall Tiles

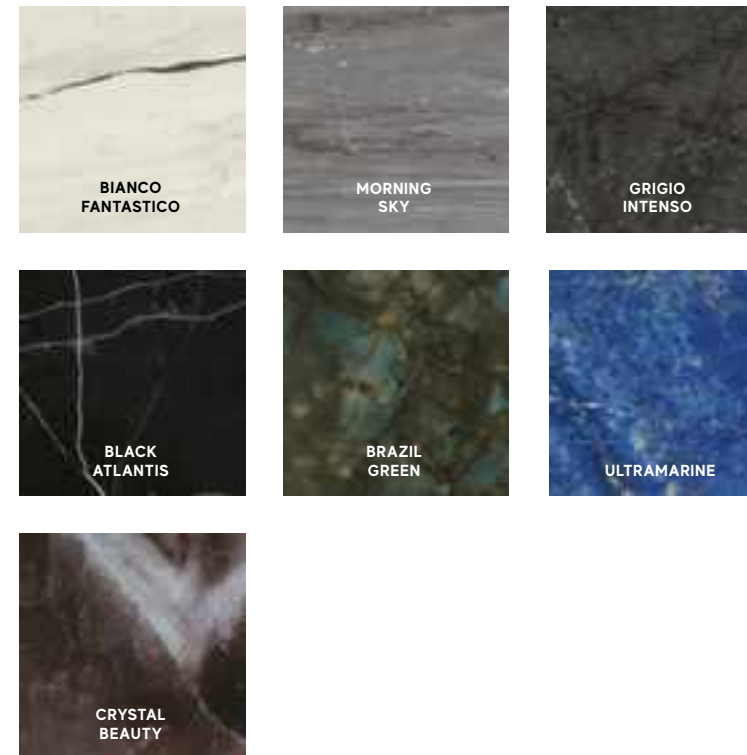

### WHITEBODY WALL TILES - RECTIFIED MONOCALIBER

Sizes	Thickness	Surface finish
50x120 cm - 19 <sup>5</sup> / <sub>8</sub> "x47 <sup>1</sup> / <sub>4</sub> "	± 8,5 mm	Shiny

\*\* On demand - Minimum order quantities must be met  
**Coloured body porcelain tiles** - Gres porcellanato colorato in massa - Grès cérame coloré dans la masse - Durchgefärbtes Feinsteinzeug - Gres porcelánico coloreado en masa - Керамический гранит окрашенный в массе  
**Whitebody wall tiles** - Rivestimenti in pasta bianca - Revêtements en pâte blanche - Weißscherbige Wandfliesen - Revestimientos en pasta blanca - Настенная плитка из белой глины  
**Rectified monocaliber** - Rettificato monocalibro - Rectifié mono-calibre - Geschliffen einkalbrig - Rectificado monocalibre - Ретифицированный в одном калибре  
**Non rectified** - Non rettificato - Non rectifié - Nicht rektifiziert - No rectificada - Неретифицированные

INDEX



PRODUCT  
FINDER



SURFACE  
RANGE



COMPANY



COLLECTIONS



- 3D WALL
- CONCRETE & RESIN LOOK
- METAL LOOK
- MARBLE LOOK
- STONE LOOK
- WOOD LOOK

LARGE SIZES



TECHNICAL  
SPECIFICATIONS





# Marvel Dream

## Porcelain Tiles

### POLISHED SURFACE



± 6 mm  
**120x278 cm** - 47<sup>1</sup>/<sub>4</sub>"x109<sup>1</sup>/<sub>2</sub>"  
 AOSE Marvel Bianco Fantastico Lapp  
 AOSF Marvel Grigio Intenso Lapp  
 AOSG Marvel Black Atlantis Lapp  
 AL2I Marvel Ultramarine Lapp ▲



± 9 mm  
**120x240 cm** - 47<sup>1</sup>/<sub>4</sub>"x94<sup>1</sup>/<sub>2</sub>"  
 A03P Marvel Bianco Fantastico Lapp  
 A03Q Marvel Grigio Intenso Lapp  
 A03R Marvel Black Atlantis Lapp



± 9 mm  
**75x150 cm** - 29<sup>1</sup>/<sub>2</sub>"x59"  
 A7FS Marvel Bianco Fantastico Lapp  
 A7FU Marvel Grigio Intenso Lapp  
 A7FT Marvel Morning Sky Lapp  
 A7FV Marvel Black Atlantis Lapp  
 A7FQ Marvel Ultramarine Lapp  
 A7FR Marvel Brazil Green Lapp  
 A7FO Marvel Crystal Beauty Lap. Book. A  
 A7FP Marvel Crystal Beauty Lap. Book. B

### MATTE SURFACE



± 6 mm  
**120x278 cm** - 47<sup>1</sup>/<sub>4</sub>"x109<sup>1</sup>/<sub>2</sub>"  
 A2RR Marvel Bianco Fantastico Matt  
 A2RQ Marvel Black Atlantis Matt



± 9 mm  
**75x150 cm** - 29<sup>1</sup>/<sub>2</sub>"x59"  
 A7HY Marvel Bianco Fantastico Matt  
 A7HØ Marvel Grigio Intenso Matt  
 A7HZ Marvel Morning Sky Matt  
 A7H1 Marvel Black Atlantis Matt

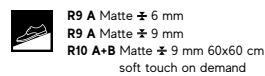

**POLISHED / SILK**  
**162x324 cm** - 63<sup>3</sup>/<sub>4</sub>"x127<sup>1</sup>/<sub>2</sub>"  
 NON RECTIFIED



± 9 mm  
**60x120 cm** - 23<sup>5</sup>/<sub>8</sub>"x47<sup>1</sup>/<sub>4</sub>"  
 AL7N Marvel Bianco Fantastico Lapp  
 AL7O Marvel Grigio Intenso Lapp  
 AL7P Marvel Black Atlantis Lapp



± 9 mm  
**60x60 cm** - 23<sup>5</sup>/<sub>8</sub>"x23<sup>5</sup>/<sub>8</sub>"  
 AL2J Marvel Bianco Fantastico Lapp  
 AL7L Marvel Grigio Intenso Lapp  
 AL2O Marvel Morning Sky Lapp  
 AL7M Marvel Black Atlantis Lapp



± 9 mm  
**37.5x75 cm** - 14<sup>3</sup>/<sub>4</sub>"x29<sup>1</sup>/<sub>2</sub>"  
 AOR8 Marvel Bianco Fantastico Lapp  
 AOSA Marvel Grigio Intenso Lapp  
 AOR9 Marvel Morning Sky Lapp  
 AOSD Marvel Black Atlantis Lapp



± 9 mm  
**60x120 cm** - 23<sup>5</sup>/<sub>8</sub>"x47<sup>1</sup>/<sub>4</sub>"  
 A21B Marvel Bianco Fantastico Matt  
 A21A Marvel Black Atlantis Matt



± 9 mm  
**60x60 cm** - 23<sup>5</sup>/<sub>8</sub>"x23<sup>5</sup>/<sub>8</sub>"  
 AL2J Marvel Bianco Fantastico Matt  
 AL2L Marvel Grigio Intenso Matt  
 AL2K Marvel Morning Sky Matt  
 AL2M Marvel Black Atlantis Matt



± 9 mm  
**37.5x75 cm** - 14<sup>3</sup>/<sub>4</sub>"x29<sup>1</sup>/<sub>2</sub>"  
 AOSH Marvel Bianco Fantastico Matt  
 AOSJ Marvel Grigio Intenso Matt  
 AOSI Marvel Morning Sky Matt  
 AOSK Marvel Black Atlantis Matt



BIANCO FANTASTICO



MORNING SKY



GRIGIO INTENSO



BLACK ATLANTIS



BRAZIL GREEN

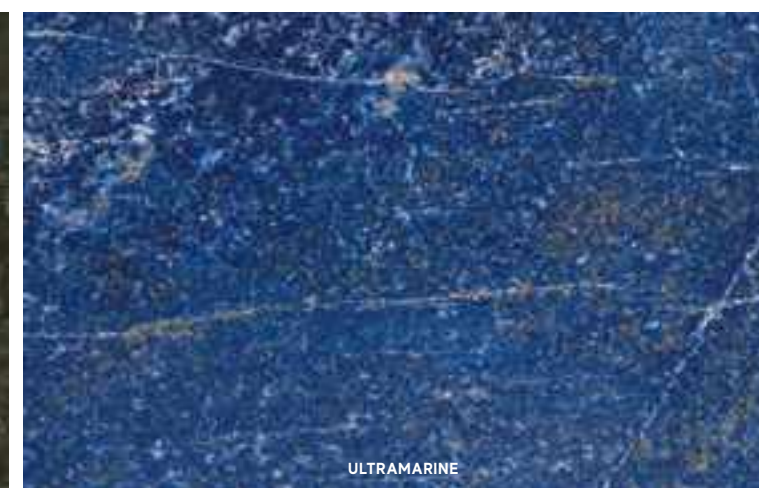

ULTRAMARINE



CRYSTAL BEAUTY BOOKMATCH

\*Bianco Fantastico, Grigio Intenso, Crystal Beauty, Black Atlantis  
 \*\*Brazil Green, Morning Sky, Ultramarine

▲ **Ultramarine 120x278 cm: glazed porcelain tiles** - Ultramarine 120x278 cm: gres porcelánico esmaltado - Ultramarine 120x278 cm: carreaux en grès cérame émaillé - Ultramarine 120x278 cm: glasierte Feinsteinzeugfliesen - Ultramarine 120x278 cm: mosaico de gres porcelánico esmaltado - Ultramarine 120x278 cm: глазурованный керамогранит.

A polished finish is recommended for low-stress residential or commercial floors where anti-slip performance is not required. The surface's shine and superior ease of cleaning are the result of in-depth studies and extensive technical research aimed at ensuring its durability over time. If the product is in direct contact with the outside, use moisture and dirt absorption devices to prevent scratches. - La finitura lappata è indicata per pavimenti residenziali o commerciali poco sollecitati, laddove non siano richieste prestazioni anticivolo. La lucentezza e l'elevata facilità di pulizia della superficie sono frutto di studi approfonditi e accurate ricerche tecniche volte a garantirne la persistenza nel tempo. Se il prodotto è a diretto contatto con l'esterno, prevedere dei dispositivi di assorbimento dell'umidità e dello sporco per prevenire la formazione di graffi. - La finition semi-polie est indiquée pour les sols résidentiels ou commerciaux à faibles contraintes, où la performance antidérapante n'est pas requise. La brillance et la grande facilité de nettoyage de la surface sont le résultat d'études approfondies et de recherches techniques précises visant à assurer sa persistance dans le temps. Si le produit est en contact direct avec l'extérieur, prévoyez des dispositifs d'absorption de l'humidité et des poussières pour éviter la formation de rayures. - Die Oberflächenversion Geläpft eignet sich für Bodenbeläge in Wohnbereichen bzw. in gering beanspruchten Gewerberäumen, wenn keine Rutschfestigkeit erforderlich ist. Der Glanz und die einfache Reinigung der Oberfläche sind das Resultat eingehender technischer Studien, mit denen die langfristige Beständigkeit sichergestellt wurde. Kommt das Produkt direkt mit der externen Umgebung in Kontakt, so sind Feuchtigkeit und Schmutz mit geeigneten Mitteln aufzunehmen, um Kratzer zu vermeiden. - El acabado lapeado es adecuado para pavimentos residenciales o comerciales con poco tráfico, donde no se requiere un efecto antideslizante. El brillo y la gran facilidad de limpieza de la superficie son el resultado de profundos estudios e investigaciones técnicas precisas para asegurar su persistencia en el tiempo. Si el producto está en contacto directo con el exterior, proporcionar dispositivos de absorción de humedad y suciedad para evitar arañazos. - Лаппатированная поверхность рекомендована для полов жилых и коммерческих помещений с невысокой интенсивностью эксплуатации, в которых от покрытий не требуется характеристик сопротивления скольжению. Блеск и легкая очистка являются результатом глубоких исследований, направленных на создание долговечного материала. Если плитка находится в непосредственном контакте с наружной средой, необходимо предусмотреть устройства поглощения влаги и грязи во избежание образования царапин.

**Polished surface** - Superficie lappata - Surface adouci - Geläppte Oberfläche - Superficie bruñido - Полуполированный поверхность  
**Matte surface** - Superficie matt - Surface Mat - Matte Oberfläche - Superficie Mate - Матовая поверхность

INDEX

PRODUCT FINDER

SURFACE RANGE

COMPANY

COLLECTIONS

- 3D WALL
- CONCRETE & RESIN LOOK
- METAL LOOK
- MARBLE LOOK
- STONE LOOK
- WOOD LOOK

LARGE SIZES

TECHNICAL SPECIFICATIONS

Marble Look

# Marvel Dream

## Porcelain Tiles

### DECOR RANGE

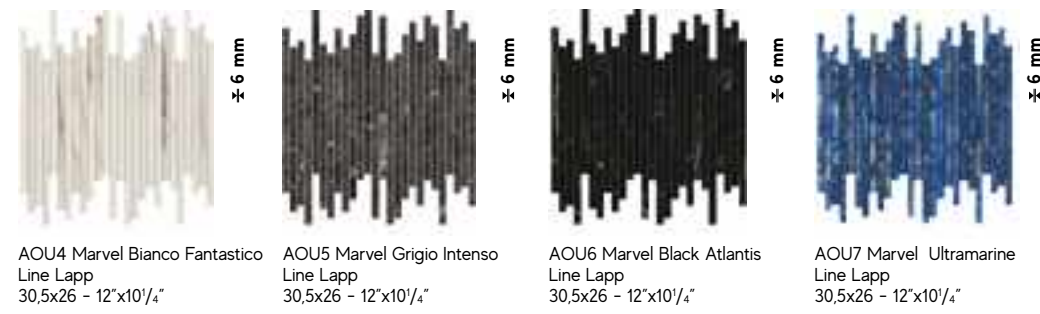

AO4 Marvel Bianco Fantastico Line Lapp 30,5x26 - 12"x10<sup>1</sup>/<sub>4</sub>"  
 AO5 Marvel Grigio Intenso Line Lapp 30,5x26 - 12"x10<sup>1</sup>/<sub>4</sub>"  
 AO6 Marvel Black Atlantis Line Lapp 30,5x26 - 12"x10<sup>1</sup>/<sub>4</sub>"  
 AO7 Marvel Ultramarine Line Lapp 30,5x26 - 12"x10<sup>1</sup>/<sub>4</sub>"

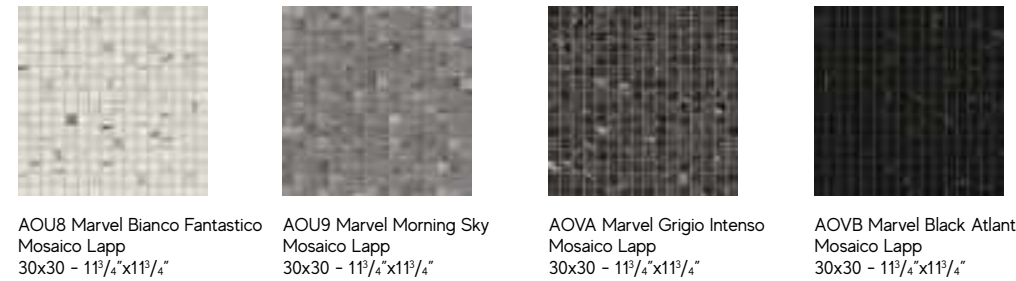
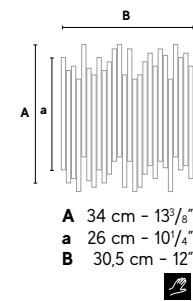

AO8 Marvel Bianco Fantastico Mosaico Lapp 30x30 - 11<sup>3</sup>/<sub>4</sub>"x11<sup>3</sup>/<sub>4</sub>"  
 AO9 Marvel Morning Sky Mosaico Lapp 30x30 - 11<sup>3</sup>/<sub>4</sub>"x11<sup>3</sup>/<sub>4</sub>"  
 AOVA Marvel Grigio Intenso Mosaico Lapp 30x30 - 11<sup>3</sup>/<sub>4</sub>"x11<sup>3</sup>/<sub>4</sub>"  
 AOVB Marvel Black Atlantis Mosaico Lapp 30x30 - 11<sup>3</sup>/<sub>4</sub>"x11<sup>3</sup>/<sub>4</sub>"

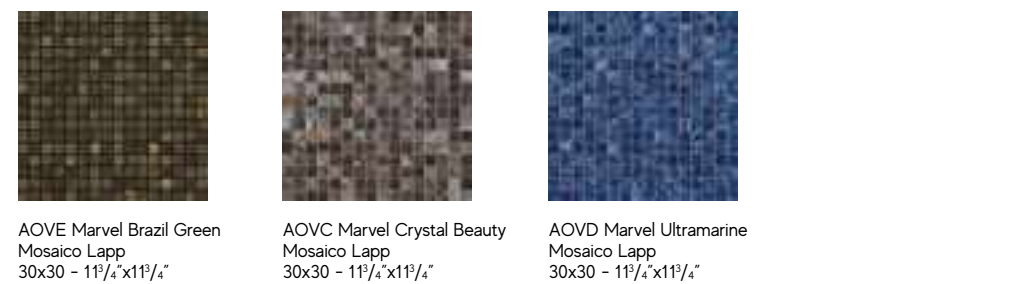
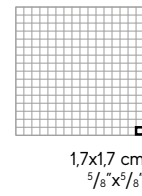

AOVE Marvel Brazil Green Mosaico Lapp 30x30 - 11<sup>3</sup>/<sub>4</sub>"x11<sup>3</sup>/<sub>4</sub>"  
 AOVC Marvel Crystal Beauty Mosaico Lapp 30x30 - 11<sup>3</sup>/<sub>4</sub>"x11<sup>3</sup>/<sub>4</sub>"  
 AOVD Marvel Ultramarine Mosaico Lapp 30x30 - 11<sup>3</sup>/<sub>4</sub>"x11<sup>3</sup>/<sub>4</sub>"

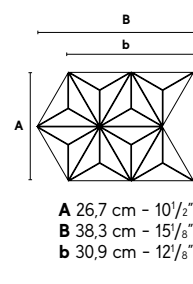

AOVP Marvel Star Lapp 26,7x30,9 - 10<sup>1</sup>/<sub>2</sub>"x12<sup>1</sup>/<sub>8</sub>"

Grigio Intenso + Crystal Beauty + Black Atlantis

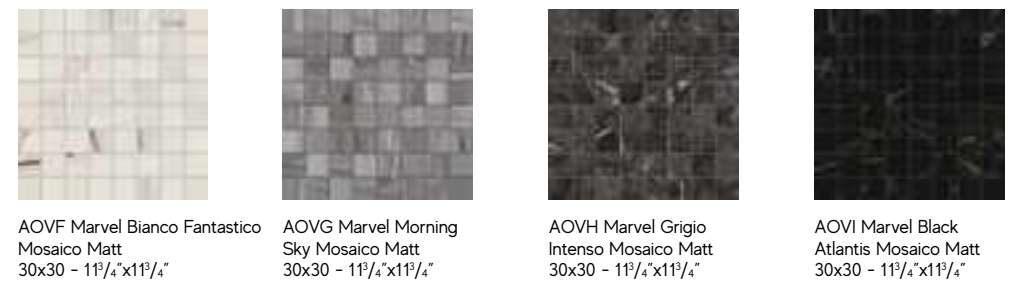

AOVF Marvel Bianco Fantastico Mosaico Matt 30x30 - 11<sup>3</sup>/<sub>4</sub>"x11<sup>3</sup>/<sub>4</sub>"  
 AOVG Marvel Morning Sky Mosaico Matt 30x30 - 11<sup>3</sup>/<sub>4</sub>"x11<sup>3</sup>/<sub>4</sub>"  
 AOVH Marvel Grigio Intenso Mosaico Matt 30x30 - 11<sup>3</sup>/<sub>4</sub>"x11<sup>3</sup>/<sub>4</sub>"  
 AOVI Marvel Black Atlantis Mosaico Matt 30x30 - 11<sup>3</sup>/<sub>4</sub>"x11<sup>3</sup>/<sub>4</sub>"

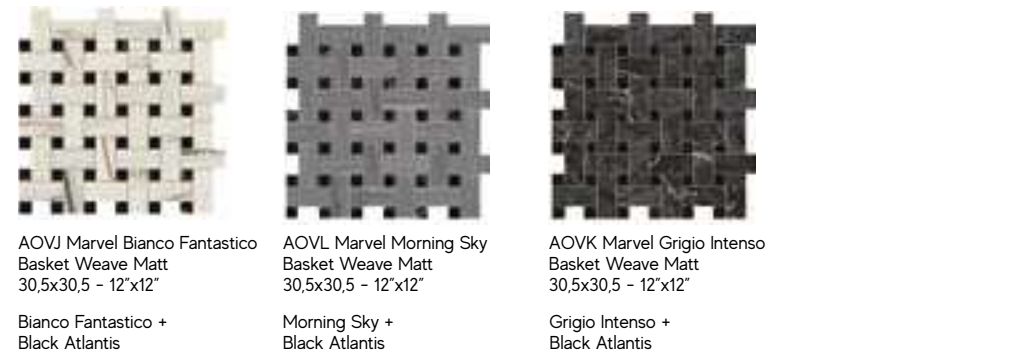
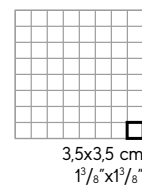

AOVI Marvel Bianco Fantastico Basket Weave Matt 30,5x30,5 - 12"x12"  
 AOVL Marvel Morning Sky Basket Weave Matt 30,5x30,5 - 12"x12"  
 AOVK Marvel Grigio Intenso Basket Weave Matt 30,5x30,5 - 12"x12"

Bianco Fantastico + Black Atlantis

Morning Sky + Black Atlantis

Grigio Intenso + Black Atlantis

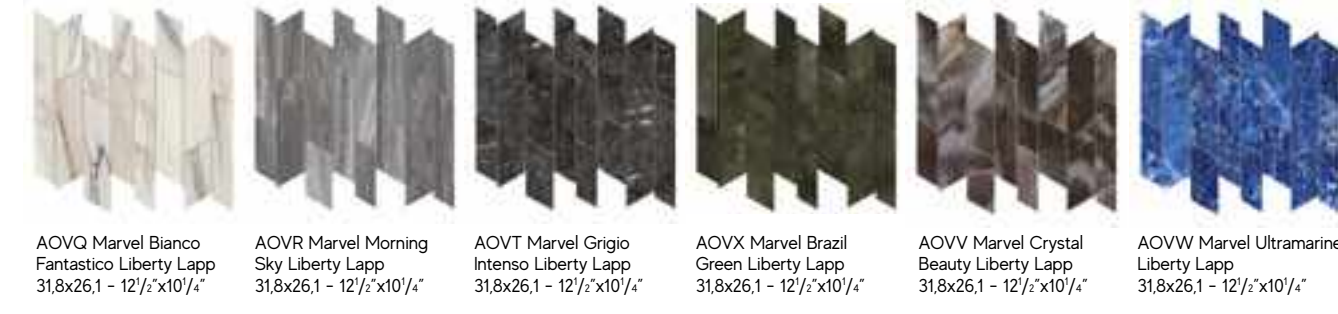
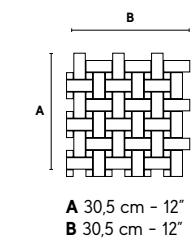

AOVQ Marvel Bianco Fantastico Liberty Lapp 31,8x26,1 - 12<sup>1</sup>/<sub>2</sub>"x10<sup>1</sup>/<sub>4</sub>"  
 AORV Marvel Morning Sky Liberty Lapp 31,8x26,1 - 12<sup>1</sup>/<sub>2</sub>"x10<sup>1</sup>/<sub>4</sub>"  
 AOVT Marvel Grigio Intenso Liberty Lapp 31,8x26,1 - 12<sup>1</sup>/<sub>2</sub>"x10<sup>1</sup>/<sub>4</sub>"  
 AOXV Marvel Brazil Green Liberty Lapp 31,8x26,1 - 12<sup>1</sup>/<sub>2</sub>"x10<sup>1</sup>/<sub>4</sub>"  
 AOYV Marvel Crystal Beauty Liberty Lapp 31,8x26,1 - 12<sup>1</sup>/<sub>2</sub>"x10<sup>1</sup>/<sub>4</sub>"  
 AOVW Marvel Ultramarine Liberty Lapp 31,8x26,1 - 12<sup>1</sup>/<sub>2</sub>"x10<sup>1</sup>/<sub>4</sub>"

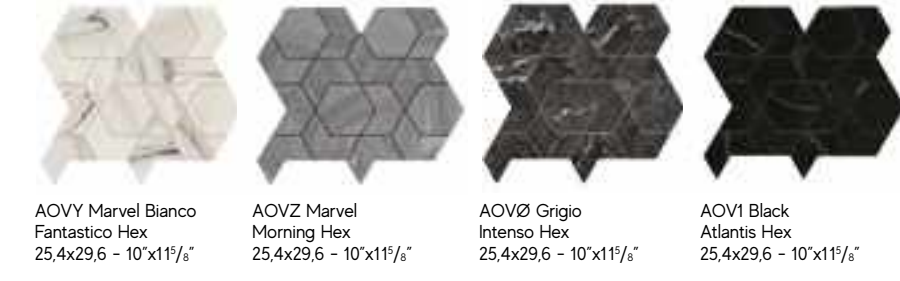
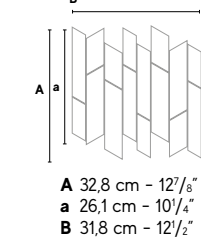

AOYV Marvel Bianco Fantastico Hex 25,4x29,6 - 10"x11<sup>1</sup>/<sub>8</sub>"  
 AOZV Marvel Morning Hex 25,4x29,6 - 10"x11<sup>1</sup>/<sub>8</sub>"  
 AOZØ Grigio Intenso Hex 25,4x29,6 - 10"x11<sup>1</sup>/<sub>8</sub>"  
 AO1 Black Atlantis Hex 25,4x29,6 - 10"x11<sup>1</sup>/<sub>8</sub>"

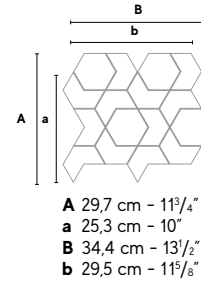

AOVO Marvel Brazil Green Leaf Lapp 42,3x27,2 - 16<sup>2</sup>/<sub>8</sub>"x10<sup>5</sup>/<sub>8</sub>"  
 AOVM Marvel Crystal Beauty Leaf Lapp 42,3x27,2 - 16<sup>2</sup>/<sub>8</sub>"x10<sup>5</sup>/<sub>8</sub>"  
 AOVN Marvel Ultramarine Leaf Lapp 42,3x27,2 - 16<sup>2</sup>/<sub>8</sub>"x10<sup>5</sup>/<sub>8</sub>"

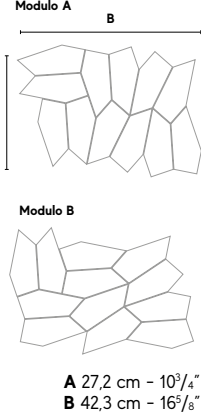

Color	Battiscopa		Gradino *		Scalino *		Scalin Ang.*		Scalin Ang.*				Battiscopa Sag. Scala *													
	Lapp	Matt	Lapp	Matt	Lapp	Matt	Lapp	Matt	Lapp	Matt	Lapp	Matt	SX	DX	SX	DX										
Bianco Fantastico	AOWE	AOWA	AOV2	AOV6	AO61	AO65	AO7L	AO7H	AO7D	AO69	-	-	APAG	APAF	AO95	AO94	-	-	AO9Z	AO9Y	AO9T	AO9S	AOWL	AOWP		
Morning Sky	AOWF	AOWB	AOV3	AOV7	AO62	AO66	AO7M	AO7I	AO7E	AO7A	-	-	APAI	APAH	AO97	AO96	-	-	AO9I	AO9Ø	AO9V	AO9U	AOWM	AOWQ		
Grigio Intenso	AOWG	AOWC	AOV4	AOV8	AO63	AO67	AO7N	AO7J	AO7F	AO7B	AO98	AO92	-	-	-	-	-	-	AO9W	AO9Q	-	-	-	-	AOWN	AOWR
Black Atlantis	AOWH	AOWD	AOV5	AOV9	AO64	AO68	AO7O	AO7K	AO7G	AO7C	AO99	AO93	-	-	-	-	-	-	AO9X	AO9R	-	-	-	-	AOWO	AOWS
Crystal Beauty	AOWI	-	-	-	-	-	AO7P	-	-	-	-	-	-	APAK	APAJ	-	-	-	-	-	-	-	-	-	-	-
Ultramarine	AOWJ	-	-	-	-	-	AO7Q	-	-	-	APAD	-	-	-	-	-	-	-	-	-	-	-	-	-	-	-
Brazil Green	AOWK	-	-	-	-	-	AO7R	-	-	-	APAE	-	-	-	-	-	-	-	-	-	-	-	-	-	-	-

\* These parts are supplied to order - I pezzi sono disponibili su ordinazione - Les pièces sont disponibles sur commande - Die Teile sind auf Bestellung lieferbar - Las piezas se hacen por encargo - Изготавливаются на заказ

The decoration can only be laid on the wall - Il decoro si può posare solo a rivestimento - Décor uniquement mural - Das Dekor kann nur an der Wand verlegt werden - La decoración se puede colocar únicamente en paredes - Декор может быть уложен только на стену.

# Marvel Dream Wall Tiles

## SHINY SURFACE



± 8.5 mm

50x120 cm - 19<sup>5</sup>/<sub>8</sub>"x47<sup>1</sup>/<sub>4</sub>"

A4SF Marvel Bianco Fantastico

A4SI Marvel Black Atlantis

A4SJ Marvel Morning Sky

A4SE Marvel Brazil Green

A4SG Marvel Grigio Intenso

A4SK Marvel Crystal Beauty

A4SH Marvel Ultramarine



V2 Slight  
Variation \*

V3 Moderate  
Variation \*\*



BIANCO FANTASTICO



BLACK ATLANTIS



MORNING SKY

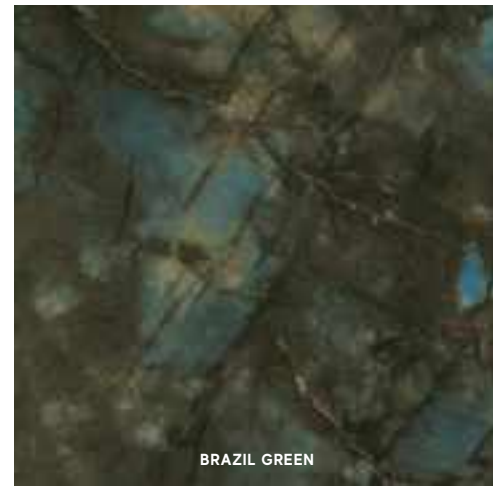

BRAZIL GREEN



GRIGIO INTENSO



CRYSTAL BEAUTY

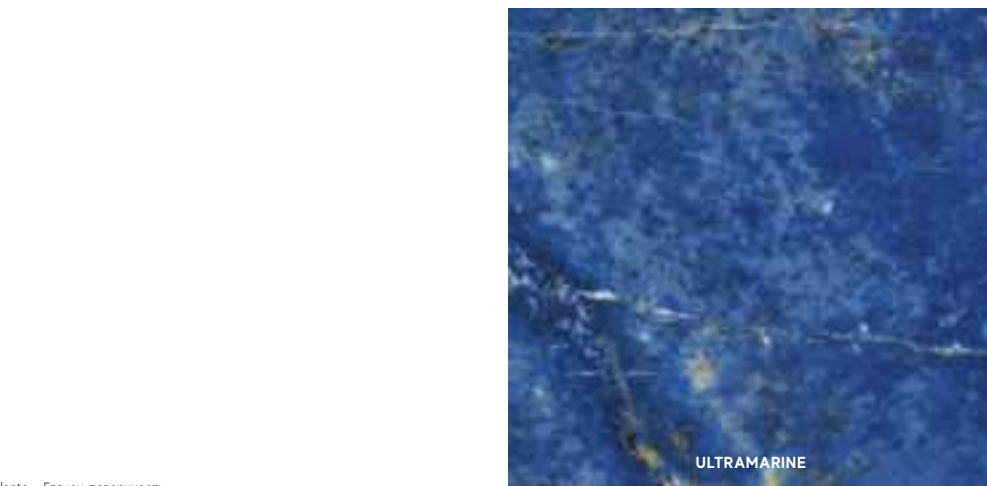

ULTRAMARINE

## TRIM TILES

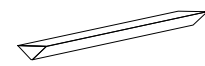

1,4x50 cm - 5<sup>5</sup>/<sub>8</sub>"x19<sup>5</sup>/<sub>8</sub>"

LD5B Marvel Bianco Fantastico Corner 50 \*

LD5S Marvel Morning Sky Corner 50 \*

LD5G Marvel Grigio Intenso Corner 50 \*

LD5N Marvel Black Atlantis Corner 50 \*

LD5M Marvel Ultramarine Corner 50 \*

LD5E Marvel Brazil Green Corner 50 \*

LD5C Marvel Crystal Beauty Corner 50 \*



1,4x1,4 cm - 5<sup>5</sup>/<sub>8</sub>"x5<sup>5</sup>/<sub>8</sub>"

MD1B Marvel Bianco Fantastico Corner A.E. 1,4 \*

MD1S Marvel Morning Sky Corner A.E. 1,4 \*

MD1G Marvel Grigio Intenso Corner A.E. 1,4 \*

MD1N Marvel Black Atlantis Corner A.E. 1,4 \*

MD1M Marvel Ultramarine Corner A.E. 1,4 \*

MD1E Marvel Brazil Green Corner A.E. 1,4 \*

MD1C Marvel Crystal Beauty Corner A.E. 1,4 \*

\* These parts are supplied to order - I pezzi sono disponibili su ordinazione - Les pièces sont disponibles sur commande - Die Teile sind auf Bestellung lieferbar - Las piezas se hacen por encargo - Изготавливаются на заказ

\*\* Bianco Fantastico, Grigio Intenso, Black Atlantis,

\*\* Brazil Green, Morning Sky, Ultramarine, Crystal Beauty

Shiny surface - Superficie lucida - Surface brillante - Glänzende Oberfläche - Superficie brillante - Глянцевая поверхность

## DECOR RANGE



9MQI Marvel Bianco Fantastico  
Mosaic Q  
30,5x30,5 - 12"x12"

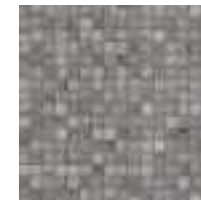

9MQS Marvel Morning Sky  
Mosaic Q  
30,5x30,5 - 12"x12"

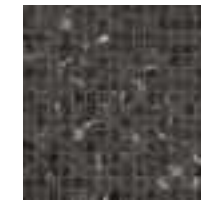

9MQG Marvel Grigio Intenso  
Mosaic Q  
30,5x30,5 - 12"x12"

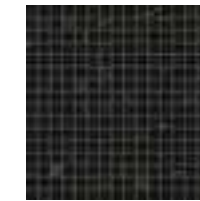

9MQK Marvel Black Atlantis  
Mosaic Q  
30,5x30,5 - 12"x12"

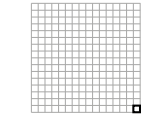

1,7x1,7 cm  
5<sup>5</sup>/<sub>8</sub>"x5<sup>5</sup>/<sub>8</sub>"



9MQH Marvel Brazil Green  
Mosaic Q  
30,5x30,5 - 12"x12"



9MQT Marvel Crystal Beauty  
Mosaic Q  
30,5x30,5 - 12"x12"



9MQD Marvel Ultramarine  
Mosaic Q  
30,5x30,5 - 12"x12"



9MFB Marvel Fan  
Bianco Fantastico  
29x29,2 - 11<sup>1</sup>/<sub>2</sub>"x11<sup>1</sup>/<sub>2</sub>"



9MFS Marvel Fan  
Morning Sky  
29x29,2 - 11<sup>1</sup>/<sub>2</sub>"x11<sup>1</sup>/<sub>2</sub>"



9MFG Marvel Fan  
Grigio Intenso  
29x29,2 - 11<sup>1</sup>/<sub>2</sub>"x11<sup>1</sup>/<sub>2</sub>"



9MFK Marvel Fan  
Black Atlantis  
29x29,2 - 11<sup>1</sup>/<sub>2</sub>"x11<sup>1</sup>/<sub>2</sub>"

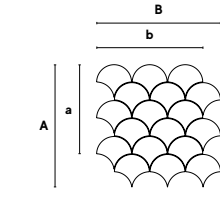

A 33,4 cm - 13<sup>1</sup>/<sub>8</sub>"  
a 29,2 cm - 11<sup>1</sup>/<sub>2</sub>"  
B 33,9 cm - 13<sup>3</sup>/<sub>8</sub>"  
b 29 cm - 11<sup>3</sup>/<sub>8</sub>"



9MFE Marvel Fan  
Brazil Green  
29x29,2 - 11<sup>1</sup>/<sub>2</sub>"x11<sup>1</sup>/<sub>2</sub>"



9MFL Marvel Fan  
Crystal Beauty  
29x29,2 - 11<sup>1</sup>/<sub>2</sub>"x11<sup>1</sup>/<sub>2</sub>"



9MFM Marvel Fan  
Ultramarine  
29x29,2 - 11<sup>1</sup>/<sub>2</sub>"x11<sup>1</sup>/<sub>2</sub>"



9MDB Marvel Diamonds  
Bianco - Black  
35,8x32,9 - 14<sup>1</sup>/<sub>8</sub>"x13"



9MDN Marvel Diamonds  
Bianco - Ultramarine  
35,8x32,9 - 14<sup>1</sup>/<sub>8</sub>"x13"



9MDG Marvel Diamonds  
Bianco - Green  
35,8x32,9 - 14<sup>1</sup>/<sub>8</sub>"x13"

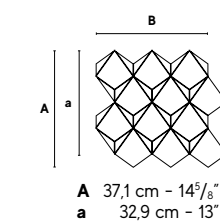

A 37,1 cm - 14<sup>5</sup>/<sub>8</sub>"  
a 32,9 cm - 13"  
B 35,8 cm - 14<sup>1</sup>/<sub>8</sub>"



9MCN Marvel Chevron •▲  
Bianco Fantastico  
17x41,4 - 6<sup>3</sup>/<sub>4</sub>"x16<sup>5</sup>/<sub>8</sub>"



9MCO Marvel Chevron •▲  
Brazil Green  
17x41,4 - 6<sup>3</sup>/<sub>4</sub>"x16<sup>5</sup>/<sub>8</sub>"



9MCP Marvel Chevron •▲  
Ultramarine  
17x41,4 - 6<sup>3</sup>/<sub>4</sub>"x16<sup>5</sup>/<sub>8</sub>"

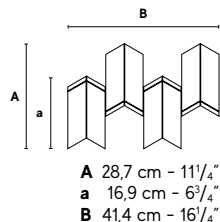

A 28,7 cm - 11<sup>1</sup>/<sub>4</sub>"  
a 16,9 cm - 6<sup>3</sup>/<sub>4</sub>"  
B 41,4 cm - 16<sup>1</sup>/<sub>4</sub>"

• For gold pieces, use an ordinary neutral cleaner. Avoid using acid or alkaline products, waxes and scour pads. - Parti in oro. Si consiglia l'utilizzo di un comune detergente neutro. Evitare l'utilizzo di prodotti acidi o alcalini, ceranti e pagliette di metallo. - Détails en or. Nous vous conseillons d'utiliser un détergent commun neutre. Évitez d'utiliser tout produit acide ou alcalin, cirants et grattoirs. - Vergoldete Teile. Verwenden Sie ein normales, neutrales Reinigungsmittel. Saure oder alkalische Produkte, Wachse und Metallschwämme sind zu vermeiden. - Partes de oro. Se aconseja utilizar un detergente neutro habitual. Hay que evitar el empleo de productos ácidos o alcalinos, ceras y estropajos de metal. - Золотые детали. Рекомендуется чистить обычным нейтральным моющим средством. Не рекомендуется использовать кислотные, щелочные, восковые средства, а также металлические мошки.

▲ One of the six sheets in the box contains a golden tile with the Atlas Concorde logo. - Uno dei sei fogli contenuti nella scatola contiene una tessera dorata con logo Atlas Concorde. - Une des six feuilles dans la boîte contient une tesselle dorée avec logo Atlas Concorde. - Eine der sechs Matten im Karton enthält ein goldfarbenes Mosaiksteinchen mit dem Atlas Concorde-Logo. - En la caja encontrarán 6 folios, uno de éstos contiene una tarjeta dorada con el logotipo Atlas Concorde. - Один из шести листов, помещенных в коробку, содержит золотую табличку с логотипом Atlas Concorde.

INDEX



PRODUCT  
FINDER



SURFACE  
RANGE



COMPANY



COLLECTIONS



- 3D WALL
- CONCRETE & RESIN LOOK
- METAL LOOK
- MARBLE LOOK
- STONE LOOK
- WOOD LOOK

LARGE SIZES



TECHNICAL  
SPECIFICATIONS



# Marvel Edge

DOWNLOAD >  
CATALOG &  
IMAGE GALLERY



ENJOY THE  
VIDEO

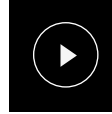

© Ceramiche Atlas Concorde



© Ceramiche Atlas Concorde



© Ceramiche Atlas Concorde

## Porcelain Tiles

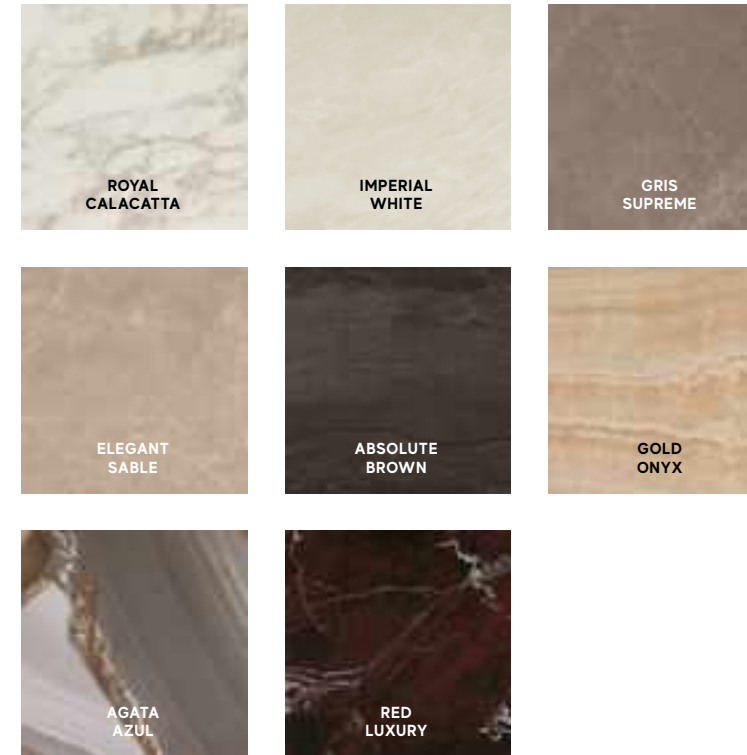

### COLOURED BODY PORCELAIN TILES - RECTIFIED MONOCALIBER

Sizes	Thickness	Surface finish
162x324 cm - 63 <sup>1</sup> / <sub>4</sub> "x127 <sup>1</sup> / <sub>2</sub> " NON RECTIFIED	± 12 mm	Polished
120x278 cm - 47 <sup>1</sup> / <sub>4</sub> "x109 <sup>1</sup> / <sub>2</sub> "	± 6 mm	Polished
120x240 cm - 47 <sup>1</sup> / <sub>4</sub> "x94 <sup>1</sup> / <sub>2</sub> "	± 9 mm	Polished
120x120 cm - 47 <sup>1</sup> / <sub>4</sub> "x47 <sup>1</sup> / <sub>4</sub> "	± 9 mm	Polished
75x150 cm - 29 <sup>1</sup> / <sub>2</sub> "x59"	± 9 mm	Polished
75x75 cm - 29 <sup>1</sup> / <sub>2</sub> "x29 <sup>1</sup> / <sub>2</sub> "	± 9 mm	Polished
45x90 cm - 17 <sup>3</sup> / <sub>8</sub> "x35 <sup>3</sup> / <sub>8</sub> "	± 9 mm	Polished
60x60 cm - 23 <sup>3</sup> / <sub>8</sub> "x23 <sup>3</sup> / <sub>8</sub> "	± 9 mm	Polished   Matte R9 A
30x60 cm - 11 <sup>3</sup> / <sub>4</sub> "x23 <sup>3</sup> / <sub>8</sub> "	± 9 mm	Polished   Matte R9 A

LARGE SIZES p. 390

## Wall Tiles

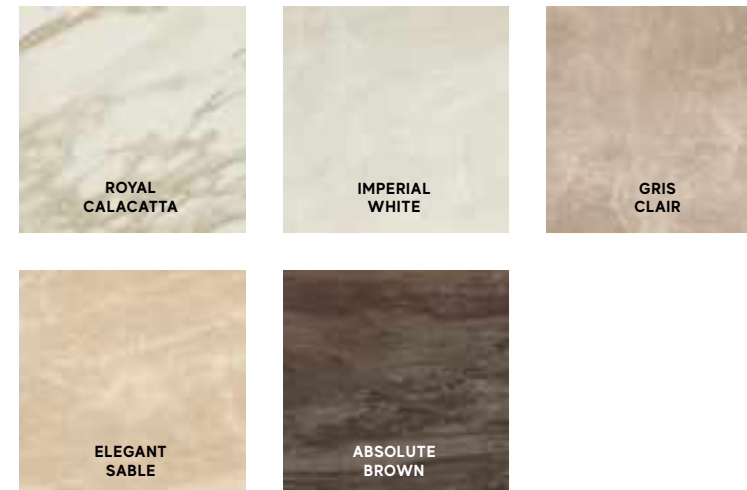

### WHITEBODY WALL TILES - RECTIFIED MONOCALIBER

Sizes	Thickness	Surface finish
50x120 cm - 19 <sup>3</sup> / <sub>8</sub> "x47 <sup>1</sup> / <sub>4</sub> "	± 8,5 mm	Shiny
40x80 cm - 15 <sup>3</sup> / <sub>4</sub> "x31 <sup>1</sup> / <sub>2</sub> "	± 8,5 mm	Shiny

Coloured body porcelain tiles - Gres porcellanato colorato in massa - Grès cérame coloré dans la masse - Durchgefärbtes Feinsteinzeug - Gres porcelánico coloreado en masa - Керамический гранит окрашенный в массе  
 Whitebody wall tiles - Rivestimenti in pasta bianca - Revêtements en pâte blanche - Weißscherbige Wandfliesen - Revestimientos en pasta blanca - Настенная плитка из белой глины  
 Rectified monocaliber - Rettificato monocalibro - Rectifié mono-calibre - Geschliffen einkalbrig - Rectificado monocalibre - Ретифицированный в одном калибре  
 Non rectified - Non rettificato - Non rectifié - Nicht rektifiziert - No rectificada - Неретифицированные

INDEX



PRODUCT  
FINDER



SURFACE  
RANGE



COMPANY



COLLECTIONS



- 3D WALL
- CONCRETE & RESIN LOOK
- METAL LOOK
- MARBLE LOOK
- STONE LOOK
- WOOD LOOK

LARGE SIZES



TECHNICAL  
SPECIFICATIONS



# Marvel Edge

## Porcelain Tiles

### POLISHED SURFACE



± 6 mm  
**120x278 cm** - 47<sup>1</sup>/<sub>4</sub>"x109<sup>1</sup>/<sub>2</sub>"  
 AØBH Marvel Royal Calacatta Lapp  
 AOQC Marvel Absolute Brown Lapp



± 9 mm  
**120x240 cm** - 47<sup>1</sup>/<sub>4</sub>"x94<sup>1</sup>/<sub>2</sub>"  
 AENU Marvel Royal Calacatta Lapp



± 9 mm  
**120x120 cm** - 47<sup>1</sup>/<sub>4</sub>"x47<sup>1</sup>/<sub>4</sub>"  
 AENP Marvel Royal Calacatta Lapp  
 AENQ Marvel Imperial White Lapp  
 AENK Marvel Elegant Sable Lapp  
 AENN Marvel Gris Supreme Lapp  
 AENO Marvel Absolute Brown Lapp



± 9 mm  
**60x60 cm** - 23<sup>5</sup>/<sub>8</sub>"x23<sup>5</sup>/<sub>8</sub>"  
 AEN4 Marvel Royal Calacatta Lapp  
 AEN5 Marvel Imperial White Lapp  
 AEN1 Marvel Elegant Sable Lapp  
 AEN2 Marvel Gris Supreme Lapp  
 AEN3 Marvel Absolute Brown Lapp



± 9 mm  
**30x60 cm** - 11<sup>3</sup>/<sub>4</sub>"x23<sup>5</sup>/<sub>8</sub>"  
 AEN9 Marvel Royal Calacatta Lapp  
 AEOA Marvel Imperial White Lapp  
 AEN6 Marvel Elegant Sable Lapp  
 AEN7 Marvel Gris Supreme Lapp  
 AEN8 Marvel Absolute Brown Lapp



± 9 mm  
**75x150 cm** - 29<sup>1</sup>/<sub>2</sub>"x59"  
 A7FZ Marvel Royal Calacatta Lapp  
 A7FØ Marvel Imperial White Lapp  
 A7FW Marvel Elegant Sable Lapp  
 A7FX Marvel Gris Supreme Lapp  
 A7FY Marvel Absolute Brown Lapp  
 A7F1 Marvel Gold Onyx Lapp  
 A7F2 Marvel Agata Azul Lapp  
 A7F3 Marvel Red Luxury Lapp



± 9 mm  
**75x75 cm** - 29<sup>1</sup>/<sub>2</sub>"x29<sup>1</sup>/<sub>2</sub>"  
 AAIW Marvel Royal Calacatta Lapp  
 AAIX Marvel Imperial White Lapp  
 AAIS Marvel Elegant Sable Lapp  
 AAIT Marvel Gris Supreme Lapp  
 AAIU Marvel Absolute Brown Lapp  
 AAIY Marvel Gold Onyx Lapp  
 AAIO Marvel Agata Azul Lapp  
 AAIS Marvel Red Luxury Lapp



± 9 mm  
**45x90 cm** - 17<sup>1</sup>/<sub>4</sub>"x35<sup>5</sup>/<sub>8</sub>"  
 AENZ Marvel Royal Calacatta Lapp  
 AENØ Marvel Imperial White Lapp  
 AENW Marvel Elegant Sable Lapp  
 AENX Marvel Gris Supreme Lapp  
 AENY Marvel Absolute Brown Lapp

### MATTE SURFACE



± 9 mm  
**60x60 cm** - 23<sup>5</sup>/<sub>8</sub>"x23<sup>5</sup>/<sub>8</sub>"  
 AEOE Marvel Royal Calacatta Matt  
 AEOF Marvel Imperial White Matt  
 AEOB Marvel Elegant Sable Matt  
 AEOC Marvel Gris Supreme Matt  
 AEOD Marvel Absolute Brown Matt



± 9 mm  
**30x60 cm** - 11<sup>3</sup>/<sub>4</sub>"x23<sup>5</sup>/<sub>8</sub>"  
 AEOJ Marvel Royal Calacatta Matt  
 AEOK Marvel Imperial White Matt  
 AEOG Marvel Elegant Sable Matt  
 AEOH Marvel Gris Supreme Matt  
 AEOI Marvel Absolute Brown Matt



Polished ± 6 mm  
 Polished ± 9 mm



Matte ± 9 mm



R9 A Matte ± 9 mm



V2 Slight Variation \*  
 V3 Moderate Variation \*\*



atlasPLAN  
 p. 390



**POLISHED**  
**162x324 cm** - 63<sup>3</sup>/<sub>4</sub>"x127<sup>1</sup>/<sub>2</sub>"  
 NON RECTIFIED



ROYAL CALACATTA



IMPERIAL WHITE



GRIS SUPREME

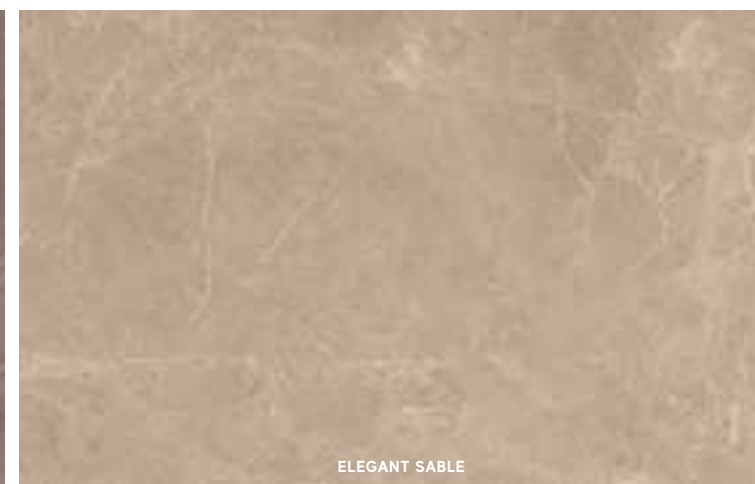

ELEGANT SABLE

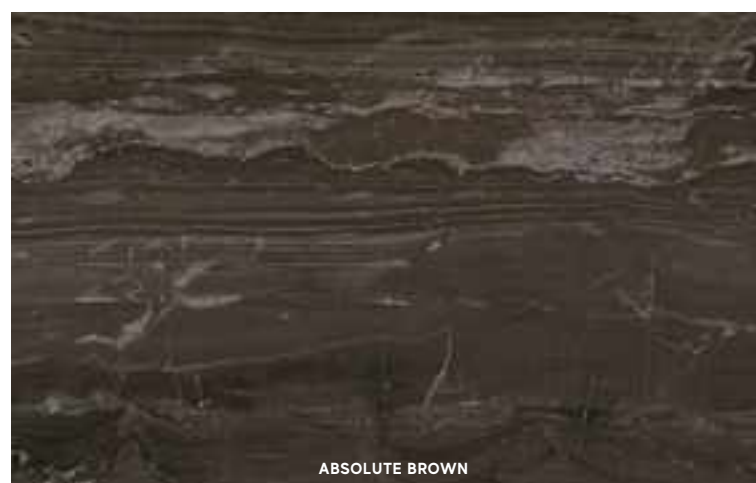

ABSOLUTE BROWN



GOLD ONYX



AGATA AZUL



RED LUXURY

\*Imperial White, Elegant Sable, Gris Supreme  
 \*\*Royal Calacatta, Absolute Brown, Gold Onyx, Agata Azul, Red Luxury

**A polished finish is recommended for low-stress residential or commercial floors where anti-slip performance is not required. The surface's shine and superior ease of cleaning are the result of in-depth studies and extensive technical research aimed at ensuring its durability over time. If the product is in direct contact with the outside, use moisture and dirt absorption devices to prevent scratches.** - La finitura lappata è indicata per pavimenti residenziali o commerciali poco sollecitati, laddove non siano richieste prestazioni antiscivolo. La lucentezza e l'elevata facilità di pulizia della superficie sono frutto di studi approfonditi e accurate ricerche tecniche volte a garantire la persistenza nel tempo. Se il prodotto è a diretto contatto con l'esterno, prevedere dei dispositivi di assorbimento dell'umidità e dello sporco per prevenire la formazione di graffi. - La finition semi-polie est indiquée pour les sols résidentiels ou commerciaux à faibles contraintes, où la performance antidérapante n'est pas requise. La brillance et la grande facilité de nettoyage de la surface sont le résultat d'études approfondies et de recherches techniques précises visant à assurer sa persistance dans le temps. Si le produit est en contact direct avec l'extérieur, prévoyez des dispositifs d'absorption de l'humidité et des poussières pour éviter la formation de rayures. - Die Oberflächenversion Geläppt eignet sich für Bodenbeläge in Wohnbereichen bzw. in gering beanspruchten Gewerberäumen, wenn keine Rutschfestigkeit erforderlich ist. Der Glanz und die einfache Reinigung der Oberfläche sind das Resultat eingehender technischer Studien, mit denen die langfristige Beständigkeit sichergestellt wurde. Kommt das Produkt direkt mit der externen Umgebung in Kontakt, so sind Feuchtigkeit und Schmutz mit geeigneten Mitteln aufzunehmen, um Kratzer zu vermeiden. - El acabado laseado es adecuado para pavimentos residenciales o comerciales con poco tráfico, donde no se requiere un efecto antideslizante. El brillo y la gran facilidad de limpieza de la superficie son el resultado de profundos estudios e investigaciones técnicas precisas para asegurar su persistencia en el tiempo. Si el producto está en contacto directo con el exterior, proporcionar dispositivos de absorción de humedad y suciedad para evitar arañazos. - Лаппатированная поверхность рекомендована для полов жилых и коммерческих помещений с невысокой интенсивностью эксплуатации, в которых от покрытий не требуется характеристик сопротивления скольжению. Блеск и легкая очищаемость являются результатом глубоких исследований, направленных на создание долговечного материала. Если плитка находится в непосредственном контакте с наружной средой, необходимо предусмотреть устройства поглощения влаги и грязи во избежание образования царапин.

**Polished surface** - Superficie lappata - Surface adouci - Geläppte Oberfläche - Superficie bruhido - Полуполированный поверхность  
**Matte surface** - Superficie matt - Surface Mat - Matte Oberfläche - Superficie Mate - Матовая поверхность

INDEX



PRODUCT  
 FINDER



SURFACE  
 RANGE



COMPANY



COLLECTIONS



- 3D WALL
- CONCRETE & RESIN LOOK
- METAL LOOK
- MARBLE LOOK
- STONE LOOK
- WOOD LOOK

LARGE SIZES



TECHNICAL  
 SPECIFICATIONS



# Marvel Edge

## Porcelain Tiles

### DECOR RANGE



AEOU Marvel Imperial White  
Mosaico Matt  
30x30 - 1<sup>1</sup>/<sub>4</sub>"x1<sup>1</sup>/<sub>4</sub>"



AEOY Marvel Royal Calacatta  
Mosaico Matt  
30x30 - 1<sup>1</sup>/<sub>4</sub>"x1<sup>1</sup>/<sub>4</sub>"



AEOZ Marvel Gris Supreme  
Mosaico Matt  
30x30 - 1<sup>1</sup>/<sub>4</sub>"x1<sup>1</sup>/<sub>4</sub>"

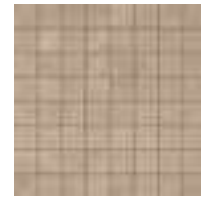

AEOQ Marvel Elegant Sable  
Mosaico Matt  
30x30 - 1<sup>1</sup>/<sub>4</sub>"x1<sup>1</sup>/<sub>4</sub>"



AEOS Marvel Absolute Brown  
Mosaico Matt  
30x30 - 1<sup>1</sup>/<sub>4</sub>"x1<sup>1</sup>/<sub>4</sub>"

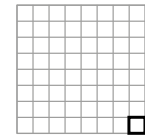

3,5x3,5 cm  
1<sup>1</sup>/<sub>8</sub>"x1<sup>1</sup>/<sub>8</sub>"

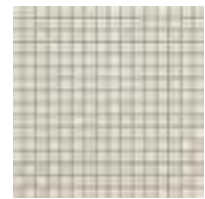

AEO1 Marvel Agata Azul  
Mosaico Lapp  
30x30 - 1<sup>1</sup>/<sub>4</sub>"x1<sup>1</sup>/<sub>4</sub>"



AEO2 Marvel Red Luxury  
Mosaico Lapp  
30x30 - 1<sup>1</sup>/<sub>4</sub>"x1<sup>1</sup>/<sub>4</sub>"



AEO3 Marvel Gold Onyx  
Mosaico Lapp  
30x30 - 1<sup>1</sup>/<sub>4</sub>"x1<sup>1</sup>/<sub>4</sub>"



AEO4 Marvel Gris Supreme  
Mosaico Lapp  
30x30 - 1<sup>1</sup>/<sub>4</sub>"x1<sup>1</sup>/<sub>4</sub>"



AEO5 Marvel Royal Calacatta  
Mosaico Lapp  
30x30 - 1<sup>1</sup>/<sub>4</sub>"x1<sup>1</sup>/<sub>4</sub>"

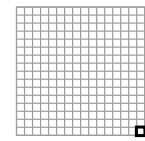

1,7x1,7 cm  
5/8"x5/8"



AEO6 Marvel Gris Supreme  
Mosaico Lapp  
30x30 - 1<sup>1</sup>/<sub>4</sub>"x1<sup>1</sup>/<sub>4</sub>"



AEO7 Marvel Royal Calacatta  
Mosaico Lapp  
30x30 - 1<sup>1</sup>/<sub>4</sub>"x1<sup>1</sup>/<sub>4</sub>"

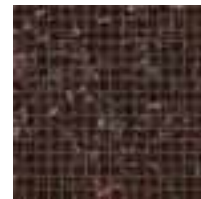

AEO8 Marvel Gris Supreme  
Mosaico Lapp  
30x30 - 1<sup>1</sup>/<sub>4</sub>"x1<sup>1</sup>/<sub>4</sub>"



AEPN Marvel Imperial White  
Mosaico 3D  
30,5x26,4 - 12"x10<sup>1</sup>/<sub>8</sub>"



AEPM Marvel Royal Calacatta  
Mosaico 3D  
30,5x26,4 - 12"x10<sup>1</sup>/<sub>8</sub>"



AEPK Marvel Gris Supreme  
Mosaico 3D  
30,5x26,4 - 12"x10<sup>1</sup>/<sub>8</sub>"



AEPJ Marvel Elegant Sable  
Mosaico 3D  
30,5x26,4 - 12"x10<sup>1</sup>/<sub>8</sub>"



AEPH Marvel Absolute Brown  
Mosaico 3D  
30,5x26,4 - 12"x10<sup>1</sup>/<sub>8</sub>"

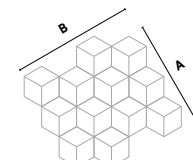

A 26,4 cm - 10<sup>3</sup>/<sub>8</sub>"  
B 30,5 cm - 12"



AEPQ Marvel Gris Supreme  
Mosaico Twill Lapp  
30,5x26,4 - 12"x10<sup>1</sup>/<sub>8</sub>"

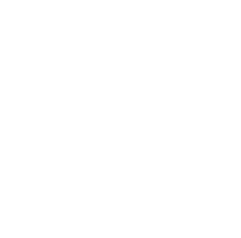

AEPD Marvel Gris Supreme  
Mosaico Twill Lapp  
30,5x26,4 - 12"x10<sup>1</sup>/<sub>8</sub>"



AEPY Marvel Royal Calacatta  
Mosaico Twill Lapp  
30,5x26,4 - 12"x10<sup>1</sup>/<sub>8</sub>"



AEPW Marvel Gris Supreme  
Mosaico Twill Lapp  
30,5x26,4 - 12"x10<sup>1</sup>/<sub>8</sub>"



AEPV Marvel Royal Calacatta  
Mosaico Twill Lapp  
30,5x26,4 - 12"x10<sup>1</sup>/<sub>8</sub>"

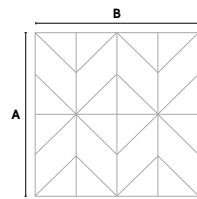

A 36,5 cm - 14<sup>3</sup>/<sub>8</sub>"  
B 36,5 cm - 14<sup>3</sup>/<sub>8</sub>"

AEPU Marvel Gris-Calacatta  
Mosaico Cubes Lapp  
36,5x36,5 - 14<sup>3</sup>/<sub>8</sub>"x14<sup>3</sup>/<sub>8</sub>"



AEPN Marvel Imperial White  
Mosaico Esagono Lapp  
30x35 - 1<sup>1</sup>/<sub>4</sub>"x1<sup>3</sup>/<sub>4</sub>"



AEPM Marvel Royal Calacatta  
Mosaico Esagono Lapp  
30x35 - 1<sup>1</sup>/<sub>4</sub>"x1<sup>3</sup>/<sub>4</sub>"



AEPK Marvel Gris Supreme  
Mosaico Esagono Lapp  
30x35 - 1<sup>1</sup>/<sub>4</sub>"x1<sup>3</sup>/<sub>4</sub>"



AEPJ Marvel Elegant Sable  
Mosaico Esagono Lapp  
30x35 - 1<sup>1</sup>/<sub>4</sub>"x1<sup>3</sup>/<sub>4</sub>"



AEPH Marvel Absolute Brown  
Mosaico Esagono Lapp  
30x35 - 1<sup>1</sup>/<sub>4</sub>"x1<sup>3</sup>/<sub>4</sub>"

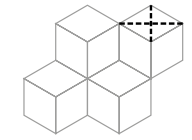

10x17 cm  
3<sup>7</sup>/<sub>8</sub>"x6<sup>7</sup>/<sub>8</sub>"



AEPN Marvel Imperial White  
Mosaico Twill Lapp  
30x31 - 1<sup>1</sup>/<sub>4</sub>"x12<sup>1</sup>/<sub>4</sub>"

Imperial White +  
Gris Supreme



AEPM Marvel Royal Calacatta  
Mosaico Twill Lapp  
30x31 - 1<sup>1</sup>/<sub>4</sub>"x12<sup>1</sup>/<sub>4</sub>"

Royal Calacatta +  
Gris Supreme



AEPK Marvel Gris Supreme  
Mosaico Twill Lapp  
30x31 - 1<sup>1</sup>/<sub>4</sub>"x12<sup>1</sup>/<sub>4</sub>"

Gris Supreme +  
Royal Calacatta



AEPJ Marvel Elegant Sable  
Mosaico Twill Lapp  
30x31 - 1<sup>1</sup>/<sub>4</sub>"x12<sup>1</sup>/<sub>4</sub>"

Elegante Sable +  
Absolute Brown



AEPH Marvel Absolute Brown  
Mosaico Twill Lapp  
30x31 - 1<sup>1</sup>/<sub>4</sub>"x12<sup>1</sup>/<sub>4</sub>"

Absolute Brown +  
Elegant Sable

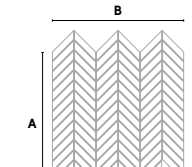

A 31 cm - 12<sup>1</sup>/<sub>4</sub>"  
B 30 cm - 11<sup>3</sup>/<sub>4</sub>"

### TRIM TILES p. 462 UPEC p. 455

	Battiscopa				Gradino *	Scalino *	Scalino *	Scalino Ang.*				Battiscopa Sag. Scala *					
	7,2x60 cm 2 <sup>1</sup> / <sub>8</sub> "x23 <sup>3</sup> / <sub>8</sub> "		Digitale 4,6x60 cm 1 <sup>1</sup> / <sub>4</sub> "x23 <sup>3</sup> / <sub>8</sub> "		30x60 cm 11 <sup>3</sup> / <sub>8</sub> "x23 <sup>3</sup> / <sub>8</sub> "	33x150 cm 13"x59"	33x90 cm 13"x35 <sup>1</sup> / <sub>8</sub> "	33x60 cm 13"x23 <sup>3</sup> / <sub>8</sub> "	33x33 cm 13"x13"				7,2x30 cm 2 <sup>1</sup> / <sub>8</sub> "x11 <sup>3</sup> / <sub>8</sub> "				
	Lapp	Matt	Lapp	Matt	Matt	Lapp	Lapp	Lapp	Matt	Lapp		Matt		Matt		SX	
										DX	SX	DX	SX	DX	SX	DX	SX
Elegant Sable	AFA9	AFA4	AFBO	AFBH	AFB4	AFCO	AFJ	AFCE	AFB9	AFC2		AFCW		AFBT		AFBZ	
Gris Supreme	AFBA	AFA5	AFBP	AFBJ	AFB5	AFCP	AFCK	AFCF	AFCA	AFC3		AFCX		AFBV		AFBØ	
Absolute Brown	AFBC	AFA6	AFBQ	AFBK	AFB6	AFCQ	AFCL	AFCG	AFCB	AFC6	AFC7	AFCØ	AFC1	AFBW		AFB1	
Royal Calacatta	AFBD	AFA7	AFBR	AFBM	AFB7	AFCR	AFCM	AFCH	AFCC	AFC4		AFCY		AFBX		AFB2	
Imperial White	AFBF	AFA8	AFBS	AFBN	AFB8	AFCS	AFCN	AFCI	AFCD	AFC5		AFCZ		AFBY		AFB3	
Gold Onyx	-	-	-	-	-	AFCT	-	-	-	-	-	-	-	-	-	-	-
Agata Azul	-	-	-	-	-	AFCU	-	-	-	-	-	-	-	-	-	-	-
Red Luxury	-	-	-	-	-	AFCV	-	-	-	-	-	-	-	-	-	-	-

\* These parts are supplied to order - I pezzi sono disponibili su ordinazione - Les pièces sont disponibles sur commande - Die Teile sind auf Bestellung lieferbar - Las piezas se hacen por encargo - Маркетологам на заказ

The decoration can only be laid on the wall - Il decoro si può posare solo a rivestimento - Décor uniquement mural - Das Dekor kann nur an der Wand verlegt werden - La decoración se puede colocar únicamente en paredes - Декор может быть уложен только на стену.

# Marvel Edge Wall Tiles

## SHINY SURFACE

$\pm 8,5$  mm  
50x120 cm - 19<sup>5</sup>/<sub>8</sub>"x47<sup>1</sup>/<sub>4</sub>"

A4SL Marvel Royal Calacatta  
A4SN Marvel Imperial White  
A4SM Marvel Elegant Sable

$\pm 8,5$  mm  
40x80 cm - 15<sup>5</sup>/<sub>4</sub>"x31<sup>1</sup>/<sub>2</sub>"

9MER Marvel Royal Calacatta  
9MEW Marvel Imperial White  
9EMG Marvel Gris Clair  
9MES Marvel Elegant Sable  
9MEB Marvel Absolute Brown



V2 Slight Variation \*  
V3 Moderate Variation \*\*

## TRIM TILES

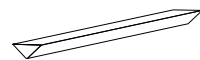

1,4x50 cm - <sup>5</sup>/<sub>8</sub>"x19<sup>3</sup>/<sub>8</sub>"  
LM5C Marvel Royal Calacatta Corner 50 \*  
LM5W Marvel Imperial White Corner 50 \*  
LM5S Marvel Elegant Sable Corner 50 \*

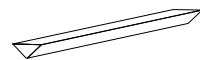

1,4x40 cm - <sup>5</sup>/<sub>8</sub>"x15<sup>3</sup>/<sub>8</sub>"  
LM4C Marvel Royal Calacatta Corner 40 \*  
LM4W Marvel Imperial White Corner 40 \*  
LM4S Marvel Elegant Sable Corner 40 \*  
LM4G Marvel Gris Clair Corner 40 \*  
LM4O Marvel Absolute Brown Corner 40 \*



1,4x1,4 cm - <sup>5</sup>/<sub>8</sub>"x<sup>5</sup>/<sub>8</sub>"  
AMCY Marvel Royal Calacatta Corner A.E. \*  
AMCX Marvel Imperial White Corner A.E. \*  
AMCS Marvel Elegant Sable Corner A.E. \*  
AMCR Marvel Gris Clair Corner A.E. \*  
AMCO Marvel Absolute Brown Corner A.E. \*

\* These parts are supplied to order - I pezzi sono disponibili su ordinazione -  
Les pièces sont disponibles sur commande - Die Teile sind auf Bestellung lieferbar -  
Las piezas se hacen por encargo - Изготавливаются на заказ

\* Imperial White, Elegant Sable, Gris Clair  
\*\* Royal Calacatta, Absolute Brown

Shiny surface - Superficie lucida - Surface brillante - Glänzende Oberfläche - Superficie brillante - Глянец поверхность



ROYAL CALACATTA



IMPERIAL WHITE



GRIS CLAIR



ELEGANT SABLE



ABSOLUTE BROWN

## DECOR RANGE

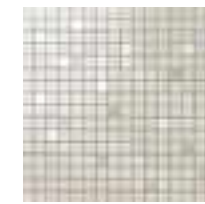

9EQW Marvel Imperial White  
Mosaic Q  
30,5x30,5 - 12"x12"

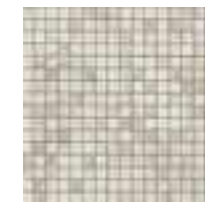

9EQC Marvel Royal Calacatta  
Mosaic Q  
30,5x30,5 - 12"x12"



9EQG Marvel Gris Clair  
Mosaic Q  
30,5x30,5 - 12"x12"



9EQS Marvel Elegant Sable  
Mosaic Q  
30,5x30,5 - 12"x12"



9EQB Marvel Absolute Brown  
Mosaic Q  
30,5x30,5 - 12"x12"

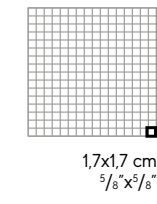

1,7x1,7 cm  
<sup>5</sup>/<sub>8</sub>"x<sup>5</sup>/<sub>8</sub>"



9EDW Marvel Imperial White  
Drop Mosaic  
27,2x29,7 - 10<sup>2</sup>/<sub>8</sub>"x11<sup>5</sup>/<sub>8</sub>"



9EDC Marvel Royal Calacatta  
Drop Mosaic  
27,2x29,7 - 10<sup>2</sup>/<sub>8</sub>"x11<sup>5</sup>/<sub>8</sub>"



9EDR Marvel Gris Clair  
Drop Mosaic  
27,2x29,7 - 10<sup>2</sup>/<sub>8</sub>"x11<sup>5</sup>/<sub>8</sub>"



9EDS Marvel Elegant Sable  
Drop Mosaic  
27,2x29,7 - 10<sup>2</sup>/<sub>8</sub>"x11<sup>5</sup>/<sub>8</sub>"



9EDB Marvel Absolute Brown  
Drop Mosaic  
27,2x29,7 - 10<sup>2</sup>/<sub>8</sub>"x11<sup>5</sup>/<sub>8</sub>"



8x5,8 cm  
<sup>3</sup>/<sub>8</sub>"x2<sup>1</sup>/<sub>4</sub>"



9EHG Marvel Gold Hex •  
Gris-Calacatta  
25,1x29 - 9<sup>7</sup>/<sub>8</sub>"x11<sup>5</sup>/<sub>8</sub>"



9EHB Marvel Gold Hex •  
Brown-Calacatta  
25,1x29 - 9<sup>7</sup>/<sub>8</sub>"x11<sup>5</sup>/<sub>8</sub>"



9EHS Marvel Gold Hex •  
Sable-Brown  
25,1x29 - 9<sup>7</sup>/<sub>8</sub>"x11<sup>5</sup>/<sub>8</sub>"

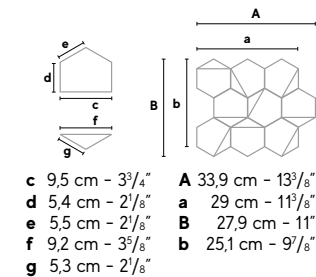

• Decor with gold insert - Decoro con inserto in oro - Décor avec insert en or - Dekor mit Goldinlage - Decoración con aplicación de oro - Декор с золотой вставкой.

INDEX



PRODUCT  
FINDER



SURFACE  
RANGE



COMPANY



COLLECTIONS



3D WALL  
CONCRETE & RESIN LOOK  
METAL LOOK  
MARBLE LOOK  
STONE LOOK  
WOOD LOOK

LARGE SIZES



TECHNICAL  
SPECIFICATIONS



# Marvel Edge Wall Tiles

## DECOR RANGE



8EGD Marvel Royal Calacatta Gold Vein 1 ●▲  
40x80 - 15 7/8"x31 1/2"



8EGE Marvel Royal Calacatta Gold Vein 2 ●▲  
40x80 - 15 7/8"x31 1/2"



8EW1 Marvel Imperial White Gold Vein 1 ●▲  
40x80 - 15 7/8"x31 1/2"



8EW2 Marvel Imperial White Gold Vein 2 ●▲  
40x80 - 15 7/8"x31 1/2"

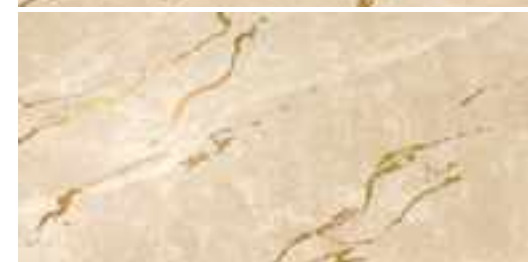
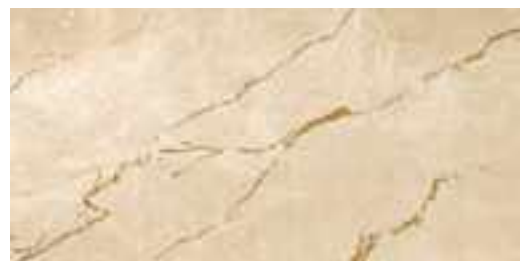

8ES1 Marvel Elegant Sable Gold Vein 1 ●▲  
40x80 - 15 7/8"x31 1/2"

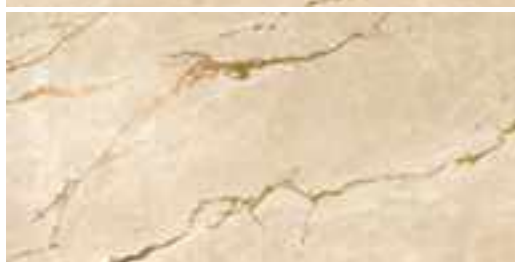

8ES2 Marvel Elegant Sable Gold Vein 2 ●▲  
40x80 - 15 7/8"x31 1/2"

● **Decor with gold insert** - Decoro con inserto in oro - Décor avec insert en or - Dekor mit Goldeinlage - Decoración con aplicación de oro - Декор с золотой вставкой.

▲ **The gold vein decoration consists of four different patterns of golden veins contained in two boxes of two pieces each: gold vein 1 and gold vein 2.** - Il decoro gold vein è composto da quattro diversi pattern di vene dorate, contenuti in due scatole da 2 pezzi ciascuna: gold vein 1 e gold vein 2. - Les décors Gold Vein sont composés de quatre différents motifs de veines dorées et sont contenus dans deux boîtes de 2 pièces chacune: Gold Vein 1 et Gold Vein 2. - Das Dekor Gold Vein setzt sich aus vier verschiedenen Motiven mit vergoldeten Äderungen zusammen, die in zwei Schachteln mit je 2 Fliesen verpackt sind: Gold Vein 1 und Gold Vein 2. - La decoración Gold Vein consta de cuatro pattern diferentes de vetas doradas, contenidas en dos cajas de 2 piezas cada una: Gold Vein 1 y Gold Vein 2. - Декор Gold Vein включает четыре разных рисунка золотистых прожилок, упакованных в две коробки по 2 штуки в каждой: Gold Vein 1 и Gold Vein 2.



© Ceramiche Atlas Concorde



© Ceramiche Atlas Concorde



© Ceramiche Atlas Concorde

INDEX



PRODUCT  
FINDER



SURFACE  
RANGE



COMPANY



COLLECTIONS



- 3D WALL
- CONCRETE & RESIN LOOK
- METAL LOOK
- MARBLE LOOK
- STONE LOOK
- WOOD LOOK

LARGE SIZES



TECHNICAL  
SPECIFICATIONS





# Marvel Gems



© Ceramiche Atlas Concorde

## Porcelain Tiles

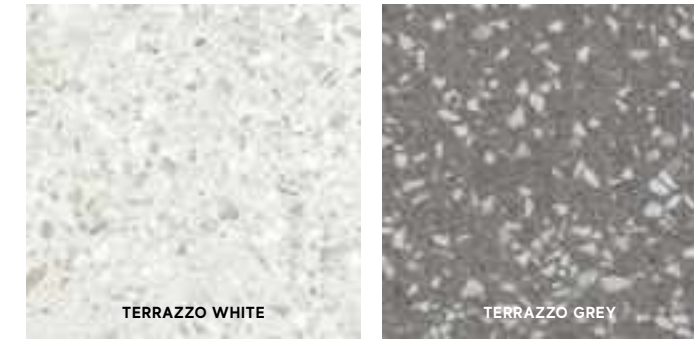

### COLOURED BODY PORCELAIN TILES - RECTIFIED MONOCALIBER

Sizes	Thickness	Surface finish
60x60 cm - 23 <sup>5</sup> / <sub>8</sub> "x23 <sup>5</sup> / <sub>8</sub> "	± 9 mm	Matte R10 A

### MATTE SURFACE

± 9 mm  
 60x60 cm - 23<sup>5</sup>/<sub>8</sub>"x23<sup>5</sup>/<sub>8</sub>"  
 ATW3 Marvel Terrazzo White  
 ATW4 Marvel Terrazzo Pearl  
 ATW5 Marvel Terrazzo Cream  
 ATW6 Marvel Terrazzo Grey  
 ATW7 Marvel Terrazzo Black

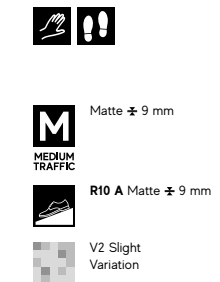

TRIM TILES  
 p. 462  
 UPEC  
 p. 455

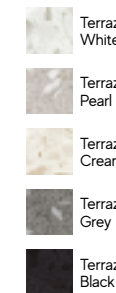

Color	Code
Terrazzo White	AT9M
Terrazzo Pearl	AT9N
Terrazzo Cream	AT9O
Terrazzo Grey	AT9P
Terrazzo Black	AT9Q

### Battiscopa

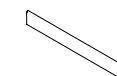

Color	Code
Digitale	AT9H
	AT9I
	AT9J
	AT9K
	AT9L

### Gradino \*



Color	Code
	AUDB
	AUDC
	AUDD
	AUDE
	AUDF

### Scalino \*

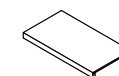

Color	Code
	AT9R
	AT9T
	AT9U
	AT9V
	AT9W

### Scalin Ang.\*

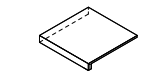

Color	Code
	AS8Y
	AS8Z
	AS8Ø
	AS81
	AS82

\* These parts are supplied to order - I pezzi sono disponibili su ordinazione - Les pièces sont disponibles sur commande - Die Teile sind auf Bestellung lieferbar - Las piezas se hacen por encargo - Изготавливаются на заказ

Coloured body porcelain tiles - Gres porcellanato colorato in massa - Grès cérame coloré dans la masse - Durchgefärbtes Feinsteinzeug - Gres porcelánico coloreado en masa - Керамический гранит окрашенный в массу  
 Rectified monocaliber - Rettificato monocalibro - Rectifié mono-calibre - Geschliffen einkalbrig - Rectificado monocolor - Ретифицированный в одном калибре  
 Matte surface - Superficie matt - Surface Mat - Matte Oberfläche - Superficie Mate - Матовая поверхность

INDEX



PRODUCT  
 FINDER



SURFACE  
 RANGE



COMPANY



COLLECTIONS



- 3D WALL
- CONCRETE & RESIN LOOK
- METAL LOOK
- MARBLE LOOK
- STONE LOOK
- WOOD LOOK

LARGE SIZES



TECHNICAL  
 SPECIFICATIONS



# Marvel Pro

DOWNLOAD >  
CATALOG &  
IMAGE GALLERY

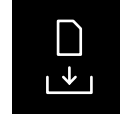

ENJOY THE  
VIDEO

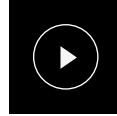

© Ceramiche Atlas Concorde



© Ceramiche Atlas Concorde



© Ceramiche Atlas Concorde

## Porcelain Tiles

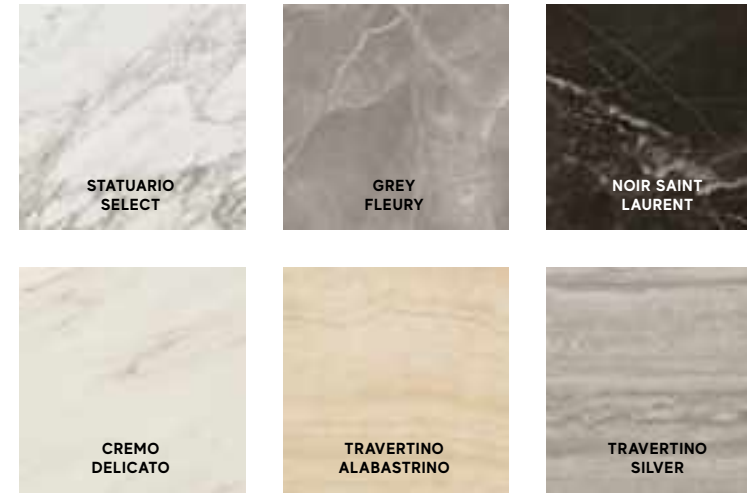

### COLOURED BODY PORCELAIN TILES - RECTIFIED MONOCALIBER

Sizes	Thickness	Surface finish
160x320 cm - 63"x126"	± 6 mm	Polished
160x160 cm - 63"x63"	± 6 mm	Polished
120x278 cm - 47 1/4"x109 1/2"	± 6 mm	Polished I Matte R9 A
120x240 cm - 47 1/4"x94 1/2"	± 9 mm	Polished
120x120 cm - 47 1/4"x47 1/4"	± 9 mm	Polished I Matte R9 A
60x120 cm - 23 3/8"x47 1/4"	± 9 mm	Polished I Matte R9 A
75x150 cm - 29 1/2"x59"	± 9 mm	Polished
75x75 cm - 29 1/2"x29 1/2"	± 9 mm	Polished
45x90 cm - 17 3/4"x35 3/8"	± 9 mm	Polished I Matte R9 A
60x60 cm - 23 3/8"x23 3/8"	± 9 mm	Polished I Matte R9 A
30x60 cm - 11 3/4"x23 3/8"	± 9 mm	Polished I Matte R9 A

LARGE SIZES p. 390

### OUTDOOR AND WET AREAS

Sizes	Thickness	Surface finish
30x60 cm - 11 3/4"x23 3/8"	± 9 mm	Textured R11 A+B

## Wall Tiles

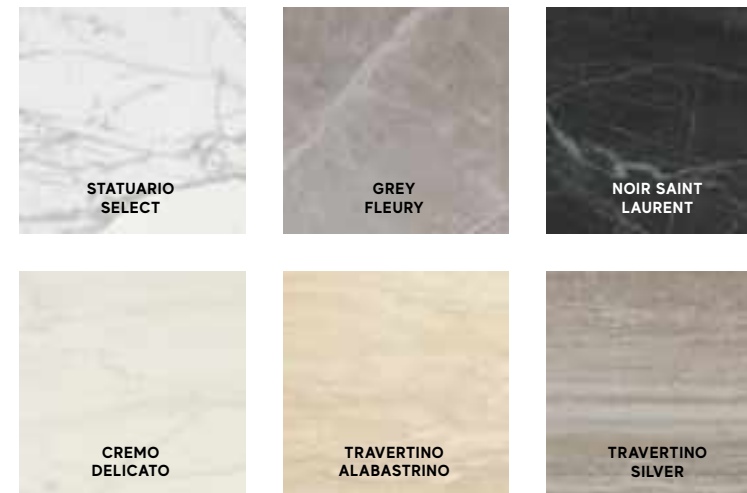

### WHITEBODY WALL TILES - RECTIFIED MONOCALIBER

Sizes	Thickness	Surface finish
50x120 cm - 19 5/8"x47 1/4"	± 8.5 mm	Shiny
40x80 cm - 15 3/4"x31 1/2"	± 8.5 mm	Shiny
30,5x91,5 cm - 12"x36"	± 8.5 mm	Shiny
8x31,5 cm - 3 1/8"x12 3/8"	± 8.5 mm	Shiny

Coloured body porcelain tiles - Gres porcellanato colorato in massa - Grès cérame coloré dans la masse - Durchgefärbtes Feinsteinzeug - Gres porcelánico coloreado en masa - Керамический гранит окрашенный в массе  
 Whitebody wall tiles - Rivestimenti in pasta bianca - Revêtements en pâte blanche - Weißscherbige Wandfliesen - Revestimientos en pasta blanca - Настенная плитка из белой глины  
 Rectified monocaliber - Rettificato monocalibro - Rectifié mono-calibre - Geschliffen einkalbrig - Rectificado monocalibre - Ретицированный в одном калибре

INDEX



PRODUCT  
FINDER



SURFACE  
RANGE



COMPANY



COLLECTIONS



- 3D WALL
- CONCRETE & RESIN LOOK
- METAL LOOK
- MARBLE LOOK
- STONE LOOK
- WOOD LOOK

LARGE SIZES



TECHNICAL  
SPECIFICATIONS



# Marvel Pro

## Porcelain Tiles

### POLISHED SURFACE



± 6 mm  
**160x320 cm** - 63"x126"  
 AO5W Marvel Crema Delicato Lapp



± 6 mm  
**160x160 cm** - 63"x63"  
 AO52 Marvel Crema Delicato Lapp



± 6 mm  
**120x278 cm** - 47 1/4"x109 1/2"  
 AØBN Marvel Statuario Select Lapp  
 AØBO Marvel Crema Delicato Lapp  
 A2RX Marvel Grey Fleury Lapp



± 9 mm  
**120x240 cm** - 47 1/4"x94 1/2"  
 AY2P Marvel Statuario Select Lapp  
 AY2Q Marvel Crema Delicato Lapp



± 9 mm  
**120x120 cm** - 47 1/4"x47 1/4"  
 AY2T Marvel Statuario Select Lapp  
 AY2U Marvel Crema Delicato Lapp  
 A21O Marvel Grey Fleury Lapp



± 9 mm  
**60x120 cm** - 23 5/8"x47 1/4"  
 A21N Marvel Crema Delicato Lapp  
 A21M Marvel Grey Fleury Lapp



± 9 mm  
**60x60 cm** - 23 5/8"x23 5/8"  
 ADUM Marvel Statuario Select Lapp  
 ADUK Marvel Crema Delicato Lapp  
 ADUO Marvel Grey Fleury Lapp  
 ADUP Marvel Noir St. Laurent Lapp  
 ADUL Marvel Travertino Alabastrino Lapp  
 ADUN Marvel Travertino Silver Lapp



± 9 mm  
**30x60 cm** - 11 5/8"x23 5/8"  
 DØ32 Marvel Statuario Select Lapp  
 DØ3Ø Marvel Crema Delicato Lapp  
 DØ34 Marvel Grey Fleury Lapp  
 DØ35 Marvel Noir St. Laurent Lapp  
 DØ31 Marvel Travertino Alabastrino Lapp  
 DØ33 Marvel Travertino Silver Lapp



± 9 mm  
**75x150 cm** - 29 1/2"x59"  
 A7F4 Marvel Statuario Select Lapp  
 A7F6 Marvel Crema Delicato Lapp  
 A7F8 Marvel Grey Fleury Lapp  
 A7F9 Marvel Noir St. Laurent Lapp  
 A7F5 Marvel Travertino Alabastrino Lapp  
 A7F7 Marvel Travertino Silver Lapp



± 9 mm  
**75x75 cm** - 29 1/2"x29 1/2"  
 AD4U Marvel Statuario Select Lapp  
 AD4W Marvel Crema Delicato Lapp  
 AD4Y Marvel Grey Fleury Lapp  
 AD4Z Marvel Noir St. Laurent Lapp  
 AD4V Marvel Travertino Alabastrino Lapp  
 AD4X Marvel Travertino Silver Lapp



± 9 mm  
**45x90 cm** - 17 3/4"x35 3/8"  
 AD49 Marvel Statuario Select Lapp  
 AD5B Marvel Crema Delicato Lapp  
 AD5D Marvel Grey Fleury Lapp  
 AD5E Marvel Noir St. Laurent Lapp  
 AD5A Marvel Travertino Alabastrino Lapp  
 AD5C Marvel Travertino Silver Lapp

\* Crema Delicato, Travertino Alabastrino, Travertino Silver, Noir St. Laurent

\*\* Statuario Select, Grey Fleury

**A polished finish is recommended for low-stress residential or commercial floors where anti-slip performance is not required. The surface's shine and superior ease of cleaning are the result of in-depth studies and extensive technical research aimed at ensuring its durability over time. If the product is in direct contact with the outside, use moisture and dirt absorption devices to prevent scratches.** - La finitura lappata è indicata per pavimenti residenziali o commerciali poco sollecitati, laddove non siano richieste prestazioni antiscivolo. La lucentezza e l'elevata facilità di pulizia della superficie sono frutto di studi approfonditi e accurate ricerche tecniche volte a garantirne la persistenza nel tempo. Se il prodotto è a diretto contatto con l'esterno, prevedere dei dispositivi di assorbimento dell'umidità e dello sporco per prevenire la formazione di graffi. - La finition semi-polie est indiquée pour les sols résidentiels ou commerciaux à faibles contraintes, où la performance antidérapante n'est pas requise. La brillance et la grande facilité de nettoyage de la surface sont le résultat d'études approfondies et de recherches techniques précises visant à assurer sa persistance dans le temps. Si le produit est en contact direct avec l'extérieur, prévoyez des dispositifs d'absorption de l'humidité et des poussières pour éviter la formation de rayures. - Die Oberflächenversion Geläpft eignet sich für Bodenbeläge in Wohnbereichen bzw. in gering beanspruchten Gewerberäumen, wenn keine Rutschfestigkeit erforderlich ist. Der Glanz und die einfache Reinigung der Oberfläche sind das Resultat eingehender technischer Studien, mit denen die langfristige Beständigkeit sichergestellt wurde. Kommt das Produkt direkt mit der externen Umgebung in Kontakt, so sind Feuchtigkeit und Schmutz mit geeigneten Mitteln aufzunehmen, um Kratzer zu vermeiden. - El acabado lapeado es adecuado para pavimentos residenciales o comerciales con poco tráfico, donde no se requiere un efecto antideslizante. El brillo y la gran facilidad de limpieza de la superficie son el resultado de profundos estudios e investigaciones técnicas precisas para asegurar su persistencia en el tiempo. Si el producto está en contacto directo con el exterior, proporcionar dispositivos de absorción de humedad y suciedad para evitar arañazos. - Лаппатированная поверхность рекомендована для полов жилых и коммерческих помещений с невысокой интенсивностью эксплуатации, в которых от покрытий не требуется характеристик сопротивления скольжению. Блеск и легкая очищаемость являются результатом глубоких исследований, направленных на создание долговечного материала. Если плитка находится в непосредственном контакте с наружной средой, необходимо предусмотреть устройства поглощения влаги и грязи во избежание образования царапин.

**Polished surface** - Superficie lappata - Surface adouci - Geläppte Oberfläche - Superficie brulido - Полуполированный поверхность



STATUARIO SELECT



CREMA DELICATO



GREYX FLEURY



TRAVERTINO ALABASTRINO



NOIR SAINT LAURENT



TRAVERTINO SILVER

INDEX



PRODUCT FINDER



SURFACE RANGE



COMPANY



COLLECTIONS



- 3D WALL
- CONCRETE & RESIN LOOK
- METAL LOOK
- MARBLE LOOK
- STONE LOOK
- WOOD LOOK

LARGE SIZES



TECHNICAL SPECIFICATIONS



# Marvel Pro

## Porcelain Tiles



Matte ± 6 mm



Matte ± 9 mm  
Textured ± 9 mm



R9 A Matte ± 6 mm  
R9 A Matte ± 9 mm  
R11 A+B Textured ± 9 mm



V2 Slight Variation \*  
V3 Moderate Variation \*\*

### MATTE SURFACE



± 6 mm  
120x278 cm - 47<sup>1</sup>/<sub>4</sub>"x109<sup>1</sup>/<sub>2</sub>"  
A2RU Marvel Crema Delicato Matt  
A2RT Marvel Grey Fleury Matt



± 9 mm  
120x120 cm - 47<sup>1</sup>/<sub>4</sub>"x47<sup>1</sup>/<sub>4</sub>"  
A2Ø6 Marvel Crema Delicato Matt  
A2Ø5 Marvel Grey Fleury Matt



± 9 mm  
60x120 cm - 23<sup>5</sup>/<sub>8</sub>"x47<sup>1</sup>/<sub>4</sub>"  
A21G Marvel Crema Delicato Matt  
A21F Marvel Grey Fleury Matt



± 9 mm  
60x60 cm - 23<sup>5</sup>/<sub>8</sub>"x23<sup>5</sup>/<sub>8</sub>"  
AVGC Marvel Statuario Select Matt  
AVGD Marvel Crema Delicato Matt  
AVGF Marvel Grey Fleury Matt  
AVGG Marvel Noir St. Laurent Matt  
AVA7 Marvel Travertino Alabastrino Matt  
AVGE Marvel Travertino Silver Matt



± 9 mm  
30x60 cm - 11<sup>3</sup>/<sub>4</sub>"x23<sup>5</sup>/<sub>8</sub>"  
D1Ø1 Marvel Statuario Select Matt  
D1Ø3 Marvel Crema Delicato Matt  
D1Ø5 Marvel Grey Fleury Matt  
D1Ø6 Marvel Noir St. Laurent Matt  
D1Ø2 Marvel Travertino Alabastrino Matt  
D1Ø4 Marvel Travertino Silver Matt



± 9 mm  
45x90 cm - 17<sup>3</sup>/<sub>4</sub>"x35<sup>5</sup>/<sub>8</sub>"  
ADKV Marvel Statuario Select Matt  
ADKX Marvel Crema Delicato Matt  
ADKZ Marvel Grey Fleury Matt  
ADKØ Marvel Noir St. Laurent Matt  
ADKW Marvel Travertino Alabastrino Matt  
ADKY Marvel Travertino Silver Matt



### TEXTURED SURFACE



± 9 mm  
30x60 cm - 11<sup>3</sup>/<sub>4</sub>"x23<sup>5</sup>/<sub>8</sub>"  
D1Ø9 Marvel Statuario Select Strutturato  
D1Ø7 Marvel Crema Delicato Strutturato  
D1Ø8 Marvel Grey Fleury Strutturato



### TRIM TILES

p. 462



p. 455

#### Battiscopa

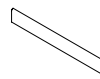

7,2x60 cm  
2<sup>7</sup>/<sub>8</sub>"x23<sup>5</sup>/<sub>8</sub>"

Matt Lapp

#### Gradino \*

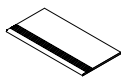

30x60 cm  
11<sup>3</sup>/<sub>4</sub>"x23<sup>5</sup>/<sub>8</sub>"

Matt

#### Scalino \*

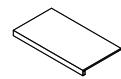

33x90 cm  
13<sup>1</sup>/<sub>2</sub>"x35<sup>5</sup>/<sub>8</sub>"

Matt

33x60 cm  
13<sup>1</sup>/<sub>2</sub>"x23<sup>5</sup>/<sub>8</sub>"

Matt

#### Scalin Ang.\*

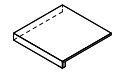

33x33 cm  
13"x13"

Matt

DX

SX

#### Battiscopa Sag. Scala \*



7,2x30 cm  
2<sup>7</sup>/<sub>8</sub>"x11<sup>3</sup>/<sub>4</sub>"

Matt

DX

SX

#### Elemento L Str. \*



15x60 H. 4 cm  
5<sup>7</sup>/<sub>8</sub>"x23<sup>5</sup>/<sub>8</sub>" H. 1<sup>1</sup>/<sub>2</sub>"

Matt

Statuario Select	ADV3	ADV9	ADW5	ADXB	ADXH	ADXQ	ADXY	ADXZ	ADYD
Crema Delicato	ADV5	ADWB	ADW7	ADXD	ADXJ	ADXR	ADX2	ADX3	ADYE
Travertino Alabastrino	ADV4	ADWA	ADW6	ADXC	ADXI	ADXU	ADXØ	ADX1	-
Travertino Silver	ADV6	ADWC	ADW8	ADXE	AD XK	ADXW	ADX4	ADX5	-
Grey Fleury	ADV7	ADWD	ADW9	ADXF	ADXL	ADXS	ADX6	ADX7	ADYF
Noir St. Laurent	ADV8	ADWE	ADXA	ADXG	ADXM	ADXT	ADX8	ADX9	-

\* These parts are supplied to order - I pezzi sono disponibili su ordinazione - Les pièces sont disponibles sur commande - Die Teile sind auf Bestellung lieferbar - Las piezas se hacen por encargo - Изготавливаются на заказ

\* Crema Delicato, Travertino Alabastrino, Travertino Silver, Noir St. Laurent  
\*\* Statuario Select, Grey Fleury

Matte surface - Superficie matt - Surface Mat - Matte Oberfläche - Superficie Mate - Матовая поверхность  
Textured surface - Superficie strutturata - Surface structuré - Strukturierte Oberfläche - Superficie estructurado - Структурная поверхность



STATUARIO SELECT



CREMA DELICATO

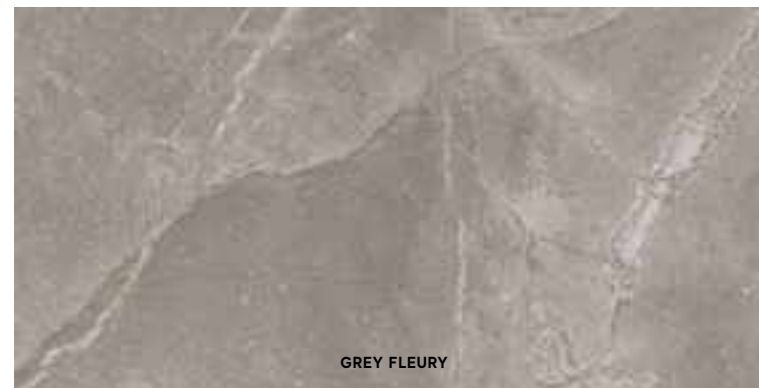

GREY FLEURY



TRAVERTINO ALABASTRINO



NOIR SAINT LAURENT



TRAVERTINO SILVER



STATUARIO SELECT TEXTURED



CREMA DELICATO TEXTURED



GREY FLEURY TEXTURED

INDEX



PRODUCT  
FINDER



SURFACE  
RANGE



COMPANY



COLLECTIONS



- 3D WALL
- CONCRETE & RESIN LOOK
- METAL LOOK
- MARBLE LOOK
- STONE LOOK
- WOOD LOOK

LARGE SIZES



TECHNICAL  
SPECIFICATIONS



# Marvel Pro

## Porcelain Tiles

### DECOR RANGE



ADP6 Marvel Statuario Select Mosaico 3D ▲  
30x30 - 1 1/4" x 1 1/4"



ADQA Marvel Grey Fleury Mosaico 3D ▲  
30x30 - 1 1/4" x 1 1/4"



ADQB Marvel Noir St. Laurent Mosaico 3D ▲  
30x30 - 1 1/4" x 1 1/4"



ADP8 Marvel Crema Delicato Mosaico 3D ▲  
30x30 - 1 1/4" x 1 1/4"



ADP7 Marvel Travertino Alabastrino Mosaico 3D ▲  
30x30 - 1 1/4" x 1 1/4"



ADP9 Marvel Travertino Silver Mosaico 3D ▲  
30x30 - 1 1/4" x 1 1/4"

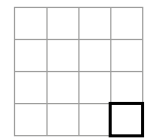

7,4x7,4 cm  
2 7/8" x 2 7/8"



ADVK Marvel Statuario Select Mosaico Esagono Lapp  
30x35 - 1 1/4" x 1 3/4"



ADVO Marvel Grey Fleury Mosaico Esagono Lapp  
30x35 - 1 1/4" x 1 3/4"



ADVP Marvel Noir St. Laurent Mosaico Esagono Lapp  
30x35 - 1 1/4" x 1 3/4"



ADVQ Marvel Mosaico Esagono Multicolor Cold  
30x35 - 1 1/4" x 1 3/4"

Statuario Select + Grey Fleury + Noir St. Laurent

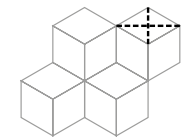

10x17 cm  
3 7/8" x 6 3/4"



ADQI Marvel Statuario Select Mosaico Matt  
30x30 - 1 1/4" x 1 1/4"



ADQM Marvel Grey Fleury Mosaico Matt  
30x30 - 1 1/4" x 1 1/4"



ADQN Marvel Noir St. Laurent Mosaico Matt  
30x30 - 1 1/4" x 1 1/4"

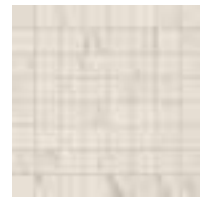

ADQK Marvel Crema Delicato Mosaico Matt  
30x30 - 1 1/4" x 1 1/4"



ADQJ Marvel Travertino Alabastrino Mosaico Matt  
30x30 - 1 1/4" x 1 1/4"



ADQL Marvel Travertino Silver Mosaico Matt  
30x30 - 1 1/4" x 1 1/4"

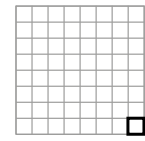

3,5x3,5 cm  
1 3/8" x 1 3/8"



ADVM Marvel Crema Delicato Mosaico Esagono Lapp  
30x35 - 1 1/4" x 1 3/4"



ADVL Marvel Travertino Alabastrino Mosaico Esagono Lapp  
30x35 - 1 1/4" x 1 3/4"



ADVN Marvel Travertino Silver Mosaico Esagono Lapp  
30x35 - 1 1/4" x 1 3/4"



ADVR Marvel Mosaico Esagono Multicolor Warm  
30x35 - 1 1/4" x 1 3/4"

Crema Delicato + Travertino Alabastrino + Noir St. Laurent



ADQC Marvel Statuario Select Mosaico Lapp  
30x30 - 1 1/4" x 1 1/4"



ADQG Marvel Grey Fleury Mosaico Lapp  
30x30 - 1 1/4" x 1 1/4"

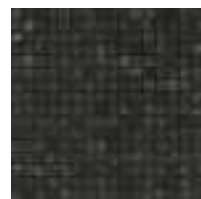

ADQH Marvel Noir St. Laurent Mosaico Lapp  
30x30 - 1 1/4" x 1 1/4"



ADQE Marvel Crema Delicato Mosaico Lapp  
30x30 - 1 1/4" x 1 1/4"



ADQD Marvel Travertino Alabastrino Mosaico Lapp  
30x30 - 1 1/4" x 1 1/4"

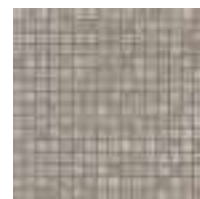

ADQF Marvel Travertino Silver Mosaico Lapp  
30x30 - 1 1/4" x 1 1/4"

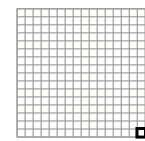

1,7x1,7 cm  
5/8" x 5/8"



AD5J Marvel Statuario Select Listello Lapp  
7x75 - 2 3/4" x 29 1/2"



ADVW Marvel Statuario Select Listello Lapp  
7x60 - 2 3/4" x 23 3/8"

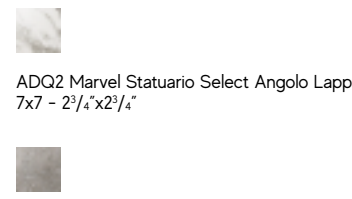

ADQ2 Marvel Statuario Select Angolo Lapp  
7x7 - 2 1/4" x 2 7/8"



AD5N Marvel Grey Fleury Listello Lapp  
7x75 - 2 3/4" x 29 1/2"

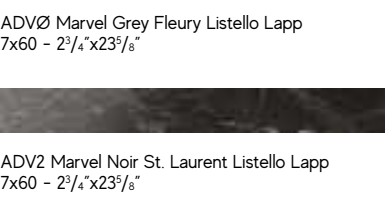

ADVØ Marvel Grey Fleury Listello Lapp  
7x60 - 2 3/4" x 23 3/8"

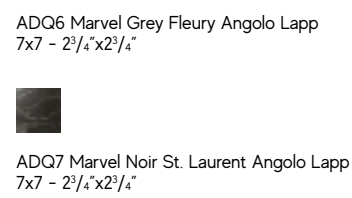

ADQ6 Marvel Grey Fleury Angolo Lapp  
7x7 - 2 1/4" x 2 7/8"



AD5O Marvel Noir St. Laurent Listello Lapp  
7x75 - 2 3/4" x 29 1/2"

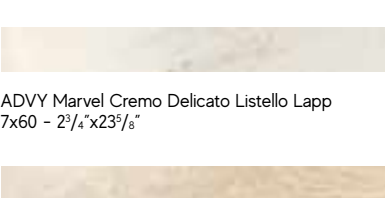

ADV2 Marvel Noir St. Laurent Listello Lapp  
7x60 - 2 3/4" x 23 3/8"

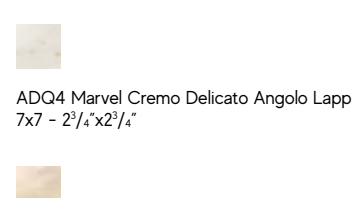

ADQ7 Marvel Noir St. Laurent Angolo Lapp  
7x7 - 2 1/4" x 2 7/8"



AD5L Marvel Crema Delicato Listello Lapp  
7x75 - 2 3/4" x 29 1/2"



ADVY Marvel Crema Delicato Listello Lapp  
7x60 - 2 3/4" x 23 3/8"

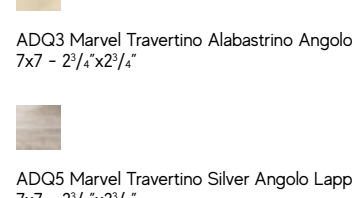

ADQ4 Marvel Crema Delicato Angolo Lapp  
7x7 - 2 1/4" x 2 7/8"

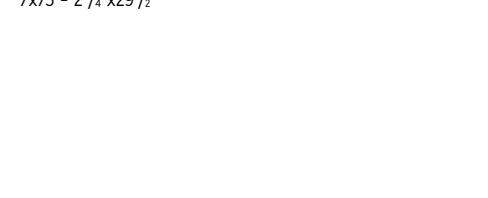

AD5K Marvel Travertino Alabastrino Listello Lapp  
7x75 - 2 3/4" x 29 1/2"

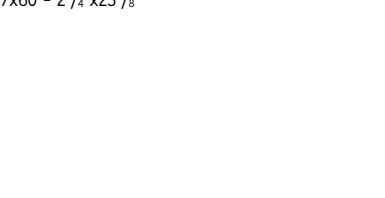

ADVX Marvel Travertino Alabastrino Listello Lapp  
7x60 - 2 3/4" x 23 3/8"

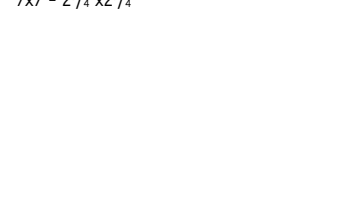

ADQ3 Marvel Travertino Alabastrino Angolo Lapp  
7x7 - 2 1/4" x 2 7/8"



AD5M Marvel Travertino Silver Listello Lapp  
7x75 - 2 3/4" x 29 1/2"



ADVZ Marvel Travertino Silver Listello Lapp  
7x60 - 2 3/4" x 23 3/8"



ADQ5 Marvel Travertino Silver Angolo Lapp  
7x7 - 2 1/4" x 2 7/8"

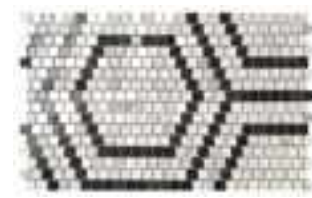

ADVA Marvel Mosaico Honeycomb Cold Lapp  
30x49 - 1 1/4" x 19 1/4"



ADVB Marvel Mosaico Honeycomb Warm Lapp  
30x49 - 1 1/4" x 19 1/4"

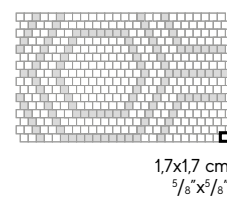

1,7x1,7 cm  
5/8" x 5/8"

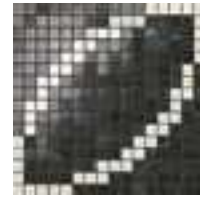

ADU9 Marvel Mosaico Circle Lapp  
30x30 - 1 1/4" x 1 1/4"

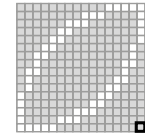

1,7x1,7 cm  
5/8" x 5/8"



ADRJ Marvel Noir/Crema Greca Mosaico  
18,5x30 - 7 1/4" x 11 1/4"

Crema Delicato + Noir St. Laurent



ADRI Marvel Noir/Crema Angolo Mosaico  
18,5x18,5 - 7 1/4" x 7 1/4"

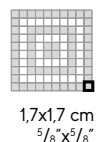

1,7x1,7 cm  
5/8" x 5/8"

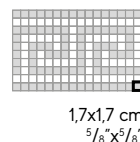

1,7x1,7 cm  
5/8" x 5/8"

▲ Multi-thickness mosaic, close joint installation without grouting - Mosaico multispessore, posa senza stuccatura a giunto unito - Mosaïque multi-épaisseur, pose sans mastic avec joint nul - Mosaik mit verschieden Stärken, fugenlose Verlegung ohne Mörtel - Mosaico multiespesor, colocación sin mástique y sin juntas - Мозаика разной толщины, укладка встык без затирки швов

■ The decoration can only be laid on the wall - Il decoro si può posare solo a rivestimento - Décor uniquement mural - Das Dekor kann nur an der Wand verlegt werden - La decoración se puede colocar únicamente en paredes - Декор может быть уложен только на стену.

# Marvel Pro

## Porcelain Tiles

### DECOR RANGE



AD5F Marvel Statuario Select Macchia Aperta Lapp A  
75x150 - 29 1/2"x59" •



AD5G Marvel Statuario Select Macchia Aperta Lapp B  
75x150 - 29 1/2"x59" •



AD5H Marvel Grey Fleury Macchia Aperta Lapp A  
75x150 - 29 1/2"x59" •



AD5I Marvel Grey Fleury Macchia Aperta Lapp B  
75x150 - 29 1/2"x59" •

In order to obtain a symmetrical open book installation pattern as reported in the charts below, it is necessary to lay an equal number of tiles of type A and B - Per ottenere la posa simmetrica a macchia aperta riportata negli schemi di posa sottostanti occorre posare un numero uguale di piastrelle di tipo A e di tipo B - Pour obtenir la pose symétrique à livre ouvert indiquée dans les schémas de pose ci-dessous, il est nécessaire de poser une quantité identique de carreaux de type A et de type B - Für die symmetrische bildfurnierte Verlegung, wie im Verlegeschema dargestellt, muss man die gleiche Anzahl von Fliesen vom Typ A und Typ B verlegen - Para obtener la colocación a libro abierto mostrada en los esquemas de colocación de abajo hay que colocar el mismo número de baldosas de tipo A y de tipo B - Для получения симметричного зеркального рисунка укладки, приведенного на схемах ниже, необходимо уложить одинаковое число плиток типа А и типа В



Layout 1 •▲



Layout 2 •▲



Layout 3 •▲

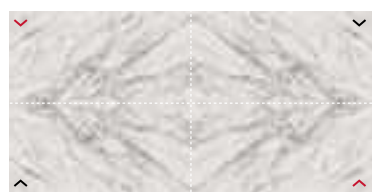

Layout 4 ▲



Layout 1 •▲

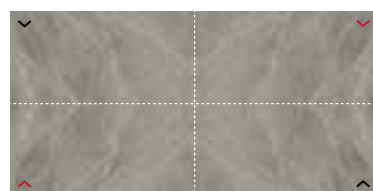

Layout 2 •▲



Layout 3 •▲

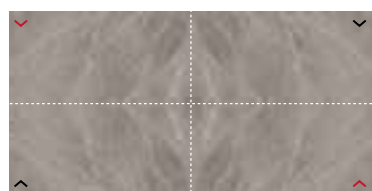

Layout 4 ▲

▲The miniatures of the multiformato module are not in proportion. - I minimali nel modulo multiformato non sono in proporzione. - Les illustrations à échelle réduite dans le Module - Multiformato ne sont pas proportionnelles. Die Abbildungen im Modul Multiformato sind nicht verhältnismäßig. - Los miniaturas en el Módulo Multiformato no están en proporción. - Изображения Multiformato модуля не соблюдают пропорций.

◆Minor misalignments in the continuity of the veins between different graphics is normal for this type of product. - Eventuali piccoli disallineamenti nella continuità delle venature tra grafiche diverse sono una caratteristica intrinseca di questa tipologia di prodotto. - Les éventuels petits désalignements de la continuité des veines entre différents graphismes sont une caractéristique intrinsèque de cette typologie de produit. - Eventuelle kleine Versätze im Verlauf der Äderungen zwischen unterschiedlichen Grafiken sind charakteristisch für dieses Produkt. - Cualquier pequeño desalineado en la continuidad de las vetas entre diferentes gráficos es una característica intrínseca de este tipo de productos. - Возможные небольшие смещения рисунка прожилок на стыке плит являются характеристикой данного вида изделий.



ADVT Marvel Elegance Angolo Dark ◆◆  
60x60 - 23 3/8"x23 3/8"

Crema Delicato + Travertino Alabastrino + Grey Fleury + Noir St. Laurent



ADVU Marvel Elegance Fascia Dark ◆  
60x60 - 23 3/8"x23 3/8"

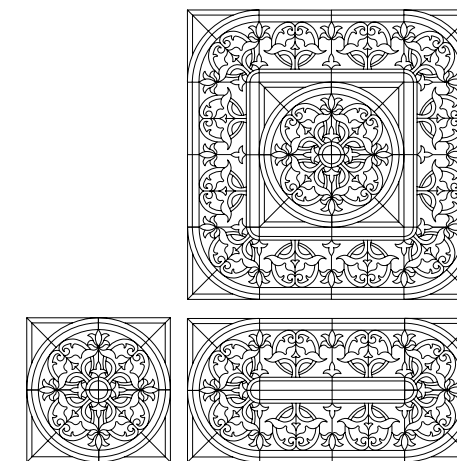

AD5T Marvel Noir St. Laurent Listello Esagono Lapp  
11x86 - 4 1/8"x33 7/8"



AD5Q Etic Rovere Listello Esagono  
11x86 - 4 1/8"x33 7/8"



AD5R Etic Noce Listello Esagono  
11x86 - 4 1/8"x33 7/8"



AD3J Etic Pallissandro Listello Esagono  
11x86 - 4 1/8"x33 7/8"



AD5P Etic Rovere Bianco Listello Esagono  
11x86 - 4 1/8"x33 7/8"

INDEX



PRODUCT  
FINDER



SURFACE  
RANGE



COMPANY



COLLECTIONS



- 3D WALL
- CONCRETE & RESIN LOOK
- METAL LOOK
- MARBLE LOOK
- STONE LOOK
- WOOD LOOK

LARGE SIZES



TECHNICAL  
SPECIFICATIONS



◆To be ordered in multiples of 4. - Ordinabile in multipli di 4. - Peut être commandé en multiples de 4. - Zum Bestellen als Vielfache von 4. - Es posible efectuar pedidos en múltiplos de 4. - Заказываются в количестве кратном 4. ◆Not matching with sizes 59x59 cm, 29.5x59 cm. - Non abbinabile ai formati 59x59 cm, 29.5x59 cm. - Ne peut être assorti aux formats 59x59 cm, 29.5x59 cm. - Nicht mit den Formaten 59x59 cm, 29.5x59 cm kombinierbar. - No combinable con los formatos 59x59 cm, 29.5x59 cm. - Не сочетается с форматами 59x59 см, 29.5x59 см.

# Marvel Pro Wall Tiles

## SHINY SURFACE



-  V2 Slight Variation \*
-  V3 Moderate Variation \*\*

± 8,5 mm

50x120 cm - 19<sup>5</sup>/<sub>8</sub>"x47<sup>1</sup>/<sub>4</sub>"

A4SW Marvel Statuario Select

A4SU Marvel Crema Delicato

A4SV Marvel Noir St. Laurent



± 8,5 mm

40x80 cm - 15<sup>7</sup>/<sub>8</sub>"x31<sup>1</sup>/<sub>2</sub>"

9M4R Marvel Statuario Select

9M4E Marvel Crema Delicato

9M4F Marvel Grey Fleury

9M4L Marvel Travertino Alabastrino

9M4O Marvel Noir St. Laurent

9M4Q Marvel Travertino Silver



± 8,5 mm

30,5x91,5 cm - 12"x36"

9M3S Marvel Statuario Select

9M3C Marvel Crema Delicato

9M3G Marvel Grey Fleury

9M3T Marvel Travertino Alabastrino

9M3N Marvel Noir St. Laurent

9M3V Marvel Travertino Silver



± 8,5 mm

8x31,5 cm - 3<sup>1</sup>/<sub>8</sub>"x12<sup>3</sup>/<sub>8</sub>"

LMKT Statuario Select Brick

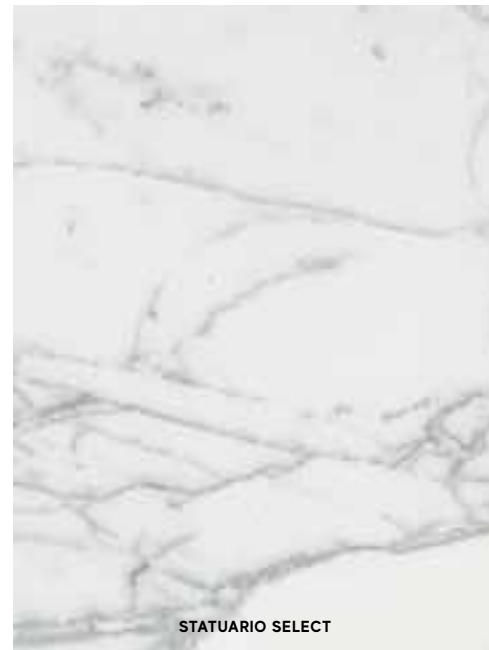

STATUARIO SELECT



CREMA DELICATO



GREY FLEURY



TRAVERTINO ALABASTRINO

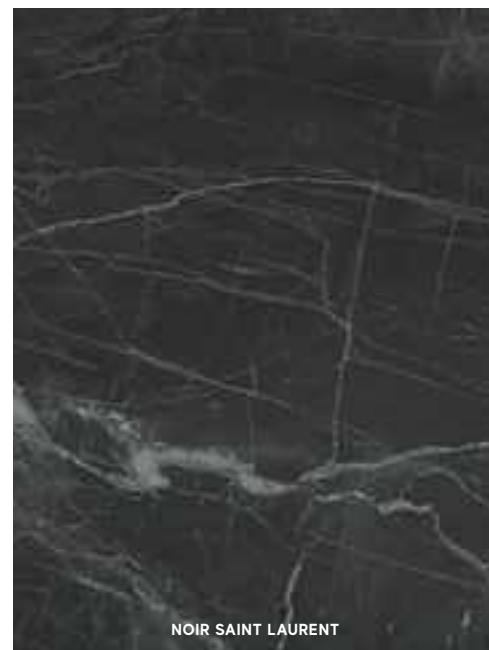

NOIR SAINT LAURENT



TRAVERTINO SILVER

## DECOR RANGE

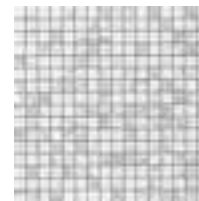

9MVS Marvel Statuario Select Mosaic  
30,5x30,5 - 12"x12"

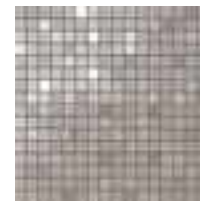

9MVE Marvel Grey Fleury Mosaic  
30,5x30,5 - 12"x12"



9MVN Marvel Noir St. Laurent Mosaic  
30,5x30,5 - 12"x12"



9MVC Marvel Crema Delicato Mosaic  
30,5x30,5 - 12"x12"

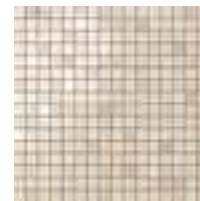

9MVT Marvel Travertino Alabastrino Mosaic  
30,5x30,5 - 12"x12"

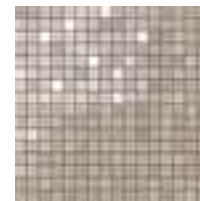

9MVB Marvel Travertino Silver Mosaic  
30,5x30,5 - 12"x12"

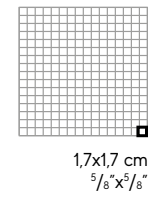

1,7x1,7 cm  
5/8"x5/8"



9MVD Marvel Grey Fleury Diagonal Mosaic  
30,5x30,5 - 12"x12"



9MVA Marvel Travertino Alabastrino Diagonal Mosaic  
30,5x30,5 - 12"x12"



9MVB Marvel Travertino Silver Diagonal Mosaic  
30,5x30,5 - 12"x12"



9MVH Marvel Noir Mix Diagonal Mosaic  
30,5x30,5 - 12"x12"

Noir St. Laurent  
+ Statuario Select



9MVF Marvel Crema Mix Diagonal Mosaic  
30,5x30,5 - 12"x12"

Crema Delicato  
+ Noir St. Laurent

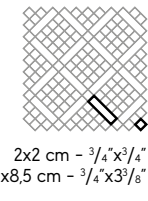

2x2 cm - 3/4"x3/4"  
2x8,5 cm - 3/4"x33/8"



9MVP Marvel Grey Fleury Net Mosaic  
30,5x30,5 - 12"x12"



9MVM Marvel Travertino Silver Net Mosaic  
30,5x30,5 - 12"x12"

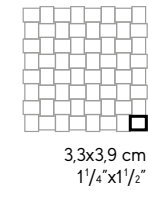

3,3x3,9 cm  
1 1/4"x1 1/2"



9MBT Marvel Travertino Alabastrino Brocade  
30,5x91,5 - 12"x36"

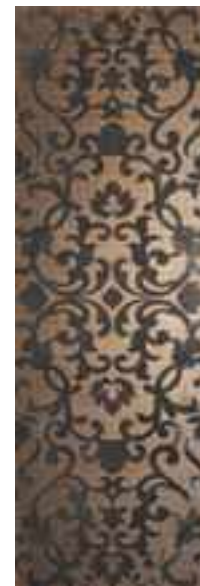

9MBN Marvel Noir St. Laurent Brocade  
30,5x91,5 - 12"x36"



8MHG Marvel Grey Fleury Hexagon  
40x80 - 15<sup>7</sup>/<sub>8</sub>"x31<sup>1</sup>/<sub>2</sub>"



LVGW Marvel Gold White •  
7,8x30,5 - 3<sup>1</sup>/<sub>8</sub>"x12"



LVGB Marvel Gold Black •  
7,8x30,5 - 3<sup>1</sup>/<sub>8</sub>"x12"



AVGW Marvel Gold White A.E. •  
7,8x1,2 - 3<sup>1</sup>/<sub>8</sub>"x1/2"



AVGB Marvel Gold Black A.E. •  
7,8x1,2 - 3<sup>1</sup>/<sub>8</sub>"x1/2"

\* Crema Delicato, Travertino Alabastrino, Travertino Silver, Noir St. Laurent  
\*\* Statuario Select, Grey Fleury

Shiny surface - Superficie lucida - Surface brillante - Glänzende Oberfläche -  
Superficie brillante - Глянцевая поверхность

INDEX



PRODUCT  
FINDER



SURFACE  
RANGE



COMPANY



COLLECTIONS



- 3D WALL
- CONCRETE & RESIN LOOK
- METAL LOOK
- MARBLE LOOK
- STONE LOOK
- WOOD LOOK

LARGE SIZES



TECHNICAL  
SPECIFICATIONS



• Decor with gold insert - Decoro con inserto in oro - Décor avec insert en or - Dekor mit Goldelinge - Decoración con aplicación de oro - Декор с золотой вставкой

# Marvel Pro Wall Tiles

## TRIM TILES



LVL S Marvel Statuario Select London  
5x30,5 - 2"x12"



AVL S Marvel London A.E.  
5x2,5 - 2"x1"



LVL G Marvel Grey Fleury London  
5x30,5 - 2"x12"



AVL G Marvel London A.E.  
5x2,5 - 2"x1"



LVL N Marvel Noir St. Laurent London  
5x30,5 - 2"x12"



AVL N Marvel London A.E.  
5x2,5 - 2"x1"

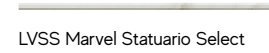

LVSS Marvel Statuario Select Spigolo  
0,85x30,5 - 3/8"x12"



AVSS Marvel Spigolo A.E.  
0,85x0,85 - 3/8"x3/8"



LVSF Marvel Grey Fleury Spigolo  
0,85x30,5 - 3/8"x12"



AVSG Marvel Spigolo A.E.  
0,85x0,85 - 3/8"x3/8"



LVSO Marvel Noir St. Laurent Spigolo  
0,85x30,5 - 3/8"x12"



AVSN Marvel Spigolo A.E.  
0,85x0,85 - 3/8"x3/8"



LVAS Marvel Statuario Select Alzata  
20x30,5 - 7/8"x12"



AVAA Marvel Alzata A.E.  
1,5x20 - 5/8"x7/8"



LVAG Marvel Grey Fleury Alzata  
20x30,5 - 7/8"x12"



AVAF Marvel Alzata A.E.  
1,5x20 - 5/8"x7/8"



LVAN Marvel Noir St. Laurent Alzata  
20x30,5 - 7/8"x12"



AVAN Marvel Alzata A.E.  
1,5x20 - 5/8"x7/8"



LVLC Marvel Crema Delicato London  
5x30,5 - 2"x12"



AVL C Marvel London A.E.  
5x2,5 - 2"x1"



LVL T Marvel Travertino Alabastrino London  
5x30,5 - 2"x12"



AVL T Marvel London A.E.  
5x2,5 - 2"x1"



LVL V Marvel Travertino Silver London  
5x30,5 - 2"x12"



AVL V Marvel London A.E.  
5x2,5 - 2"x1"



LVSE Marvel Crema Delicato Spigolo  
0,85x30,5 - 3/8"x12"



AVS C Marvel Spigolo A.E.  
0,85x0,85 - 3/8"x3/8"



LVSR Marvel Travertino Alabastrino Spigolo  
0,85x30,5 - 3/8"x12"



AVS T Marvel Spigolo A.E.  
0,85x0,85 - 3/8"x3/8"



LVSV Marvel Travertino Silver Spigolo  
0,85x30,5 - 3/8"x12"



AVS V Marvel Spigolo A.E.  
0,85x0,85 - 3/8"x3/8"



LVAC Marvel Crema Delicato Alzata  
20x30,5 - 7/8"x12"



AVAC Marvel Alzata A.E.  
1,5x20 - 5/8"x7/8"



LVAT Marvel Travertino Alabastrino Alzata  
20x30,5 - 7/8"x12"



AVAT Marvel Alzata A.E.  
1,5x20 - 5/8"x7/8"



LVAV Marvel Travertino Silver Alzata  
20x30,5 - 7/8"x12"



AVAV Marvel Alzata A.E.  
1,5x20 - 5/8"x7/8"



© Ceramiche Atlas Concorde



© Ceramiche Atlas Concorde



© Ceramiche Atlas Concorde

INDEX



PRODUCT  
FINDER



SURFACE  
RANGE



COMPANY



COLLECTIONS



- 3D WALL
- CONCRETE & RESIN LOOK
- METAL LOOK
- MARBLE LOOK
- STONE LOOK
- WOOD LOOK

LARGE SIZES



TECHNICAL  
SPECIFICATIONS





# Marvel Shine

DOWNLOAD >  
CATALOG &  
IMAGE GALLERY

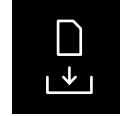

ENJOY THE  
VIDEO

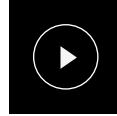

© Ceramiche Atlas Concorde



© Ceramiche Atlas Concorde



© Ceramiche Atlas Concorde

## Porcelain Tiles

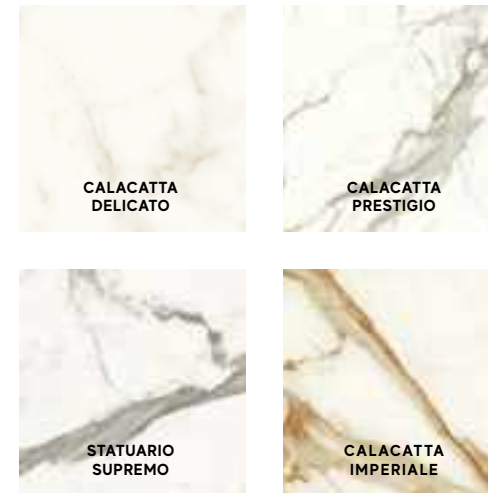

### COLOURED BODY PORCELAIN TILES - RECTIFIED MONOCALIBER

Sizes	Thickness	Surface finish
162x324 cm - 63 <sup>3</sup> / <sub>4</sub> "x127 <sup>1</sup> / <sub>2</sub> " NON RECTIFIED	± 6-12-20* mm	Polished   Silk   Satin
160x320 cm - 63"x126"	± 6 mm	Polished
160x160 cm - 63"x63"	± 6 mm	Polished
120x278 cm - 47 <sup>1</sup> / <sub>4</sub> "x109 <sup>1</sup> / <sub>2</sub> "	± 6 mm	Polished   Silk
120x240 cm - 47 <sup>1</sup> / <sub>4</sub> "x94 <sup>1</sup> / <sub>2</sub> "	± 9 mm	Polished
120x120 cm - 47 <sup>1</sup> / <sub>4</sub> "x47 <sup>1</sup> / <sub>4</sub> "	± 9 mm	Polished   Matte R9 A
60x120 cm - 23 <sup>3</sup> / <sub>8</sub> "x47 <sup>1</sup> / <sub>4</sub> "	± 9 mm	Polished   Matte R9 A
75x150 cm - 29 <sup>1</sup> / <sub>2</sub> "x59"	± 9 mm	Polished   Silk
75x75 cm - 29 <sup>1</sup> / <sub>2</sub> "x29 <sup>1</sup> / <sub>2</sub> "	± 9 mm	Polished   Silk
37,5x75 cm - 14 <sup>3</sup> / <sub>4</sub> "x29 <sup>1</sup> / <sub>2</sub> "	± 9 mm	Polished
60x60 cm - 23 <sup>3</sup> / <sub>8</sub> "x23 <sup>3</sup> / <sub>8</sub> "	± 9 mm	Polished   Silk   Matte R10 A+B SOFT TOUCH
30x60 cm - 11 <sup>1</sup> / <sub>4</sub> "x23 <sup>3</sup> / <sub>8</sub> "	± 9 mm	Silk

LARGE SIZES p. 390

## Wall Tiles



### WHITEBODY WALL TILES - RECTIFIED MONOCALIBER

Sizes	Thickness	Surface finish
50x120 cm - 19 <sup>5</sup> / <sub>8</sub> "x47 <sup>1</sup> / <sub>4</sub> "	± 8,5 mm	Silk
40x80 cm - 15 <sup>1</sup> / <sub>4</sub> "x31 <sup>1</sup> / <sub>2</sub> "	± 8,5 mm	Shiny

\* Natura-vein tech  
**Coloured body porcelain tiles** – Gres porcellanato colorato in massa – Grès cérame coloré dans la masse – Durchgefärbtes Feinsteinzeug – Gres porcelánico coloreado en masa – Керамический гранит окрашенный в массе  
**Whitebody wall tiles** – Rivestimenti in pasta bianca – Revêtements en pâte blanche – Weißscherbige Wandfliesen – Revestimientos en pasta blanca – Настенная плитка из белой глины  
**Rectified monocaliber** – Rettificato monocalibro – Rectifié mono-calibre – Geschliffen einkalbrig – Rectificado monocalibre – Ретифицированный в одном калибре  
**Non rectified** – Non rettificato – Non rectifié – Nicht rektifiziert – No rectificada – Неретифицированные

INDEX



PRODUCT  
FINDER



SURFACE  
RANGE



COMPANY



COLLECTIONS



- 3D WALL
- CONCRETE & RESIN LOOK
- METAL LOOK
- MARBLE LOOK
- STONE LOOK
- WOOD LOOK

LARGE SIZES



TECHNICAL  
SPECIFICATIONS



# Marvel Shine

## Porcelain Tiles

### POLISHED SURFACE



± 6 mm

**160x320 cm** - 63"x126"

A4RR Marvel Calacatta Prestigio Lapp

A4RS Marvel Statuario Supremo Lapp

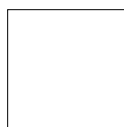

± 6 mm

**160x160 cm** - 63"x63"

A4RP Marvel Calacatta Prestigio Lapp

A4RQ Marvel Statuario Supremo Lapp



± 6 mm

**120x278 cm** - 47<sup>1</sup>/<sub>4</sub>"x109<sup>1</sup>/<sub>2</sub>"

A4OY Marvel Calacatta Delicato Lapp

A4OZ Marvel Calacatta Prestigio Lapp

A4O2 Marvel Calacatta Prestigio Bookm A Lp

A4O3 Marvel Calacatta Prestigio Bookm B Lp

A6EO Marvel Calacatta Prestigio Lapp Kit Endless

A4OØ Marvel Statuario Supremo Lapp

A4O4 Marvel Statuario Supremo Bookm A Lp

A4O5 Marvel Statuario Supremo Bookm B Lp

A6EP Marvel Statuario Supremo Lapp Kit Endless

A4O1 Marvel Calacatta Imperiale Lapp

A6EQ Marvel Calacatta Imperiale Lapp Kit Endless



± 9 mm

**120x240 cm** - 47<sup>1</sup>/<sub>4</sub>"x94<sup>1</sup>/<sub>2</sub>"

A4RH Marvel Calacatta Delicato Lapp

A4RI Marvel Calacatta Prestigio Lapp

A4RJ Marvel Statuario Supremo Lapp

A4RK Marvel Calacatta Imperiale Lapp



± 9 mm

**120x120 cm** - 47<sup>1</sup>/<sub>4</sub>"x47<sup>1</sup>/<sub>4</sub>"

A4Q8 Marvel Calacatta Delicato Lapp

A4Q9 Marvel Calacatta Prestigio Lapp

A4RA Marvel Statuario Supremo Lapp

A4RB Marvel Calacatta Imperiale Lapp



± 9 mm

**60x120 cm** - 23<sup>5</sup>/<sub>8</sub>"x47<sup>1</sup>/<sub>4</sub>"

A4QØ Marvel Calacatta Delicato Lapp

A4Q1 Marvel Calacatta Prestigio Lapp

A4Q2 Marvel Statuario Supremo Lapp

A4Q3 Marvel Calacatta Imperiale Lapp



± 9 mm

**60x60 cm** - 23<sup>5</sup>/<sub>8</sub>"x23<sup>5</sup>/<sub>8</sub>"

A4QS Marvel Calacatta Delicato Lapp

A4QT Marvel Calacatta Prestigio Lapp

A4QU Marvel Statuario Supremo Lapp

A4QV Marvel Calacatta Imperiale Lapp



± 9 mm

**75x150 cm** - 29<sup>1</sup>/<sub>2</sub>"x59"

A7GA Marvel Calacatta Delicato Lapp

A7GB Marvel Calacatta Prestigio Lapp

A7GC Marvel Statuario Supremo Lapp

A4PH Marvel Statuario Supremo Lp Macchia Aperta

A7GD Marvel Calacatta Imperiale Lapp

A4PI Marvel Calacatta Imperiale Lp Macchia Aperta



± 9 mm

**75x75 cm** - 29<sup>1</sup>/<sub>2</sub>"x29<sup>1</sup>/<sub>2</sub>"

A3WX Marvel Calacatta Delicato Lapp

A3WY Marvel Calacatta Prestigio Lapp

A3WZ Marvel Statuario Supremo Lapp

A3WØ Marvel Calacatta Imperiale Lapp



± 9 mm

**37,5x75 cm** - 14<sup>3</sup>/<sub>4</sub>"x29<sup>1</sup>/<sub>2</sub>"

A4RL Marvel Calacatta Delicato Lapp

A4RM Marvel Calacatta Prestigio Lapp

A4RN Marvel Statuario Supremo Lapp

A4RO Marvel Calacatta Imperiale Lapp



Polished ± 6 mm

Polished ± 9 mm



V2 Slight

Variation \*



V3 Moderate

Variation \*\*



atlasPLAN

p. 390



POLISHED

**162x324 cm** - 63<sup>3</sup>/<sub>4</sub>"x127<sup>1</sup>/<sub>2</sub>"

NON RECTIFIED



CALACATTA DELICATO



CALACATTA PRESTIGIO



STATUARIO SUPREMO



CALACATTA IMPERIALE

\* Calacatta Delicato, Calacatta Prestigio, Statuario Supremo

\*\* Calacatta Imperiale

**Polished and silk finishes are recommended for low-stress residential or commercial floors where anti-slip performance is not required. The surface's shine and superior ease of cleaning are the result of in-depth studies and extensive technical research aimed at ensuring its durability over time. If the product is in direct contact with the outside, use moisture and dirt absorption devices to prevent scratches.** - Le finiture lappata e silk sono indicate per pavimenti residenziali o commerciali poco sollecitati, laddove non siano richieste prestazioni antiscivolo. La lucidezza e l'elevata facilità di pulizia della superficie sono frutto di studi approfonditi e accurate ricerche tecniche volte a garantirne la persistenza nel tempo. Se il prodotto è a diretto contatto con l'esterno, prevedere dei dispositivi di assorbimento dell'umidità e dello sporco per prevenire la formazione di graffi. - Les finitions rodée et soyeuse conviennent aux sols résidentiels ou commerciaux à faibles contraintes, où la performance antidérapante n'est pas requise. La brillance et la grande facilité de nettoyage de la surface sont le résultat d'études approfondies et de recherches techniques précises visant à assurer sa persistance dans le temps. Si le produit est en contact direct avec l'extérieur, prévoyez des dispositifs d'absorption de l'humidité et de la saleté pour éviter la formation de rayures. - Die Oberflächenversionen Geläpft und Silk eignen sich für Bodenbeläge in Wohnbereichen bzw. in gering beanspruchten Gewerberäumen, wenn keine Rutschfestigkeit erforderlich ist. Der Glanz und die einfache Reinigung der Oberfläche sind das Resultat eingehender technischer Studien, mit denen die langfristige Beständigkeit sichergestellt wurde. Kommt das Produkt direkt mit der externen Umgebung in Kontakt, so sind Feuchtigkeit und Schmutz mit geeigneten Mitteln aufzunehmen, um Kratzer zu vermeiden. - Los acabados lapeados y silk son adecuados para pavimentos residenciales y comerciales con poco tráfico, donde no se requiere un efecto antideslizante. El brillo y la gran facilidad de limpieza de la superficie son el resultado de profundos estudios e investigaciones técnicas precisas para asegurar su persistencia en el tiempo. Si el producto está en contacto directo con el exterior, proporcionar dispositivos de absorción de humedad y suciedad para evitar arañazos. - Лапатированная поверхность и поверхность Silk рекомендованы для полов жилых и коммерческих помещений с невысокой интенсивностью эксплуатации, в которых от покрытий не требуется характеристик сопротивления скольжению. Блеск и легкая очищаемость являются результатом глубоких исследований, направленных на создание долговечного материала. Если плитка находится в непосредственном контакте с наружной средой, необходимо предусмотреть устройства поглощения влаги и грязи во избежание образования царапин.

**Polished surface** - Superficie lappata - Surface adouci - Geläppte Oberfläche - Superficie brulido - Полуполированный поверхность

INDEX

PRODUCT  
FINDERSURFACE  
RANGE

COMPANY



COLLECTIONS



3D WALL

CONCRETE &amp; RESIN LOOK

METAL LOOK

MARBLE LOOK

STONE LOOK

WOOD LOOK

LARGE SIZES

TECHNICAL  
SPECIFICATIONS

# Marvel Shine

## Porcelain Tiles

### SILK SURFACE



± 6 mm  
**120x278 cm** - 47<sup>1</sup>/<sub>4</sub>"x109<sup>1</sup>/<sub>2</sub>"  
 A4O6 Marvel Calacatta Prestigio Silk  
 A6ER Marvel Calacatta Prestigio Silk Kit Endless  
 A4O7 Marvel Statuario Supremo Silk  
 A6ES Marvel Statuario Supremo Silk Kit Endless



± 9 mm  
**75x150 cm** - 29<sup>1</sup>/<sub>2</sub>"x59"  
 A7H2 Marvel Calacatta Delicato Silk  
 A7H3 Marvel Calacatta Prestigio Silk  
 A7H4 Marvel Statuario Supremo Silk  
 A7H5 Marvel Calacatta Imperiale Silk



± 9 mm  
**75x75 cm** - 29<sup>1</sup>/<sub>2</sub>"x29<sup>1</sup>/<sub>2</sub>"  
 A3W1 Marvel Calacatta Delicato Silk  
 A3W2 Marvel Calacatta Prestigio Silk  
 A3W4 Marvel Statuario Supremo Silk  
 A3W5 Marvel Calacatta Imperiale Silk



± 9 mm  
**60x60 cm** - 23<sup>5</sup>/<sub>8</sub>"x23<sup>5</sup>/<sub>8</sub>"  
 A5TC Marvel Calacatta Delicato Silk  
 A5TD Marvel Calacatta Prestigio Silk  
 A5TE Marvel Statuario Supremo Silk  
 A5TF Marvel Calacatta Imperiale Silk



± 9 mm  
**30x60 cm** - 11<sup>1</sup>/<sub>4</sub>"x23<sup>5</sup>/<sub>8</sub>"  
 A5TG Marvel Calacatta Delicato Silk  
 A5TH Marvel Calacatta Prestigio Silk  
 A5TI Marvel Statuario Supremo Silk  
 A5TJ Marvel Calacatta Imperiale Silk

### MATTE SURFACE



± 9 mm  
**120x120 cm** - 47<sup>1</sup>/<sub>4</sub>"x47<sup>1</sup>/<sub>4</sub>"  
 A4Q4 Marvel Calacatta Delicato Matt  
 A4Q5 Marvel Calacatta Prestigio Matt  
 A4Q6 Marvel Statuario Supremo Matt  
 A4Q7 Marvel Calacatta Imperiale Matt



± 9 mm  
**60x120 cm** - 23<sup>5</sup>/<sub>8</sub>"x47<sup>1</sup>/<sub>4</sub>"  
 A4QW Marvel Calacatta Delicato Matt  
 A4QX Marvel Calacatta Prestigio Matt  
 A4QY Marvel Statuario Supremo Matt  
 A4QZ Marvel Calacatta Imperiale Matt



± 9 mm  
**60x60 cm** - 23<sup>5</sup>/<sub>8</sub>"x23<sup>5</sup>/<sub>8</sub>"  
 A4QO Marvel Calacatta Delicato R10B Soft Touch  
 A4QQ Marvel Calacatta Prestigio R10B Soft Touch  
 A4QR Marvel Statuario Supremo R10B Soft Touch  
 A4QP Marvel Calacatta Imperiale R10B Soft Touch

**M** Silk ± 6 mm  
 Silk ± 9 mm  
**H** Matte ± 9 mm  
**R9 A** Matte ± 9 mm  
**R10 A+B** Soft Touch ± 9 mm 60x60 cm

V2 Slight Variation \*  
 V3 Moderate Variation \*\*



**SILK / SATIN**  
**162x324 cm** - 63<sup>3</sup>/<sub>4</sub>"x127<sup>1</sup>/<sub>2</sub>"  
 NON RECTIFIED



TRIM TILES p. 462	Battiscopa			Gradino *			Scalino *		Scalin Ang.*		Scalin Ang.*		Corner * ± 6 mm		Corner A.E * ± 6 mm	Battiscopa Sag. Scala *											
	Lapp	Silk	Matt	Lapp	Silk	Matt	Lapp	Silk	Lapp	Silk	Lapp	Matt	Silk	Lapp	Silk	Lapp	Lapp	Silk	Matt	Silk							
	A43T	A43P	A535	A43H	A539	A55F	A435	A54W	A443	A44Z	A3CV	A441	A543	A45K	A45G	A45C	A547	A55B	A45O	-	A45U	A54G	A54K	A43X	A431	A54O	A54S
	A43U	A43Q	A536	A43I	A54D	A55G	A436	A54X	A444	A44Ø	A54Ø	A44J	A544	A45L	A45H	A45D	A548	A55C	A45P	A45S	A45X	A54H	A54L	A43Y	A432	A54P	A54T
	A43V	A43R	A537	A43J	A54E	A55H	A437	A54Y	A445	A441	A541	A44K	A545	A45M	A45I	A45E	A549	A55D	A45Q	A45T	A45W	A54I	A54M	A43Z	A433	A54Q	A54U
	A43W	A43S	A538	A43K	A54F	A55I	A438	A54Z	A446	A442	A542	A44L	A546	A45N	A45J	A45F	A55A	A55E	A45R	-	A45V	A54J	A54N	A43Ø	A434	A54R	A54V

\* These parts are supplied to order - I pezzi sono disponibili su ordinazione - Les pièces sont disponibles sur commande - Die Teile sind auf Bestellung lieferbar - Las piezas se hacen por encargo - Изготавливаются на заказ

\* Calacatta Delicato, Calacatta Prestigio, Statuario Supremo  
 \*\* Calacatta Imperiale

Polished and silk finishes are recommended for low-stress residential or commercial floors where anti-slip performance is not required. The surface's shine and superior ease of cleaning are the result of in-depth studies and extensive technical research aimed at ensuring its durability over time. If the product is in direct contact with the outside, use moisture and dirt absorption devices to prevent scratches. - Le finiture lappata e silk sono indicate per pavimenti residenziali o commerciali poco sollecitati, laddove non siano richieste prestazioni antiscivolo. La lucentezza e l'elevata facilità di pulizia della superficie sono frutto di studi approfonditi e accurate ricerche tecniche volte a garantirne la persistenza nel tempo. Se il prodotto è a diretto contatto con l'esterno, prevedere dei dispositivi di assorbimento dell'umidità e dello sporco per prevenire la formazione di graffi. - Les finitions rodée et soyeuse conviennent aux sols résidentiels ou commerciaux à faibles contraintes, où la performance antidérapante n'est pas requise. La brillance et la grande facilité de nettoyage de la surface sont le résultat d'études approfondies et de recherches techniques précises visant à assurer sa persistance dans le temps. Si le produit est en contact direct avec l'extérieur, prévoyez des dispositifs d'absorption de l'humidité et de la saleté pour éviter la formation de rayures. - Die Oberflächenversionen Glapplatt und Silk eignen sich für Bodenbeläge in Wohnbereichen bzw. in gering beanspruchten Gewerberäumen, wenn keine Rutschfestigkeit erforderlich ist. Der Glanz und die einfache Reinigung der Oberfläche sind das Resultat eingehender technischer Studien, mit denen die langfristige Beständigkeit sichergestellt wurde. Kommt das Produkt direkt mit der externen Umgebung in Kontakt, so sind Feuchtigkeit und Schmutz mit geeigneten Mitteln aufzunehmen, um Kratzer zu vermeiden. - Los acabados lapeados y silk son adecuados para pavimentos residenciales y comerciales con poco tráfico, donde no se requiere un efecto antideslizante. El brillo y la gran facilidad de limpieza de la superficie son el resultado de profundos estudios e investigaciones técnicas precisas para asegurar su persistencia en el tiempo. Si el producto está en contacto directo con el exterior, proporcionar dispositivos de absorción de humedad y suciedad para evitar arañazos. - Лаплатированная поверхность и поверхность Silk рекомендованы для полов жилых и коммерческих помещений с невысокой интенсивностью эксплуатации, в которых от покрытий не требуется характеристик сопротивления скольжению. Блеск и легкая очищаемость являются результатом глубоких исследований, направленных на создание долговечного материала. Если плитка находится в непосредственном контакте с наружной средой, необходимо предусмотреть устройства поглощения влаги и грязи во избежание образования царапин.

Silk surface - Superficie silk - Surface Silk - Silk Oberfläche - Superficie Silk - Поверхность Silk  
 Matte surface - Superficie matt - Surface Mat - Matte Oberfläche - Superficie Mate - Матовая поверхность

INDEX



PRODUCT  
FINDER



SURFACE  
RANGE



COMPANY



COLLECTIONS



- 3D WALL
- CONCRETE & RESIN LOOK
- METAL LOOK
- MARBLE LOOK
- STONE LOOK
- WOOD LOOK

LARGE SIZES



TECHNICAL  
SPECIFICATIONS



# Marvel Shine

## Porcelain Tiles

### MACCHIA APERTA, SUGGESTED COMPOSITION

A4PI Marvel Calacatta Imperiale Lappato Macchia Aperta - 75x150 - 29 1/2"x59"

LAYOUT A

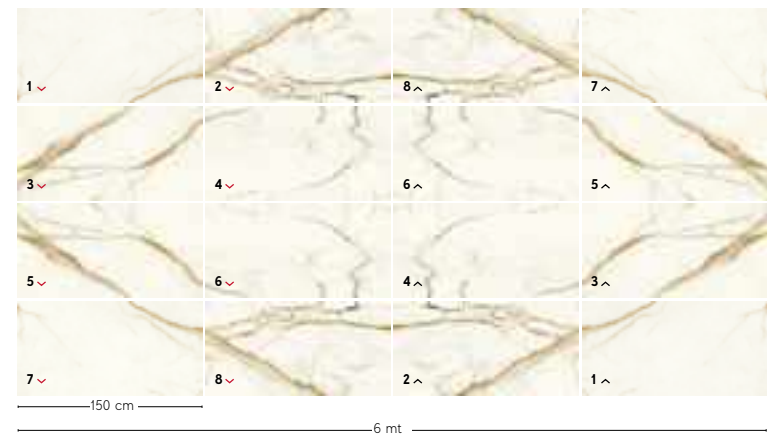

LAYOUT B



LAYOUT C



LAYOUT D

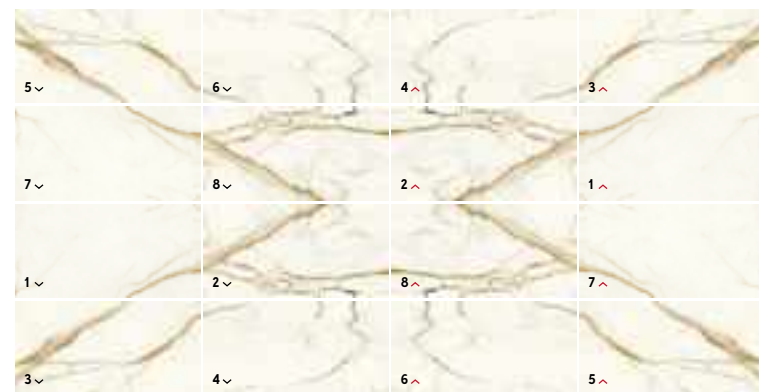

A4PH Marvel Statuario Supremo Lappato Macchia Aperta - 75x150 - 29 1/2"x59"

LAYOUT E



LAYOUT F

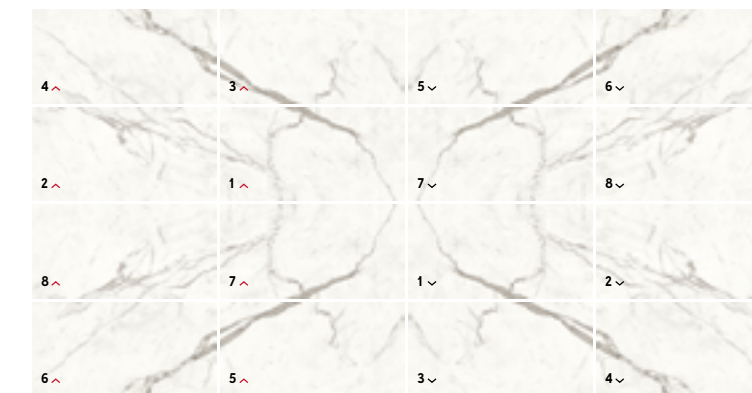

LAYOUT G



LAYOUT H

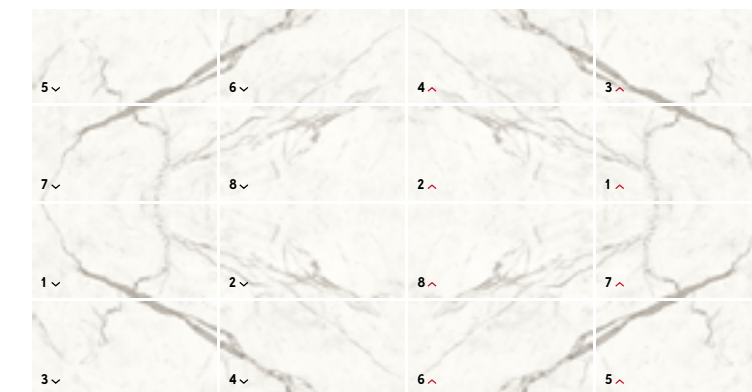

The collection allows creating an open vein measuring 6 m x 3 m (16 75x150 slabs) ideal for large rooms where you can enhance the entire interior design. The junction between the graphics that make up the open vein is not geometrically perfect but imitates the natural irregularity of the open veins of natural marble products. The code "polished open vein" corresponds to a pallet composed of 16 tiles in the 75x150 cm (8+8) format that make up the entire open vein. A number is printed on the edge of each tile (see laying diagram).

La collezione permette di creare una macchia aperta di dimensioni 6m x 3m (16 facce di 75x150) ideale per ambienti ampi nei quali poter valorizzare l'intera composizione. La giunzione tra le grafiche che compongono la macchia aperta non è geometricamente perfetta ma imita la naturale irregolarità delle macchie aperte dei prodotti in marmo naturale. Il codice "lappato macchia aperta" corrisponde ad un pallet composto da 16 piastrelle in formato 75cmx150cm (8+8) che compongono l'intera macchia aperta. Sulla costa di ciascuna piastrella è stampato il numero corrispondente (vedi schema di posa).

La collection permet de créer une tache ouverte de 6m x 3m (16 faces de 75x150) idéale pour les grandes pièces où l'on peut mettre en valeur l'ensemble de la composition. La jonction entre les graphismes qui composent la tache ouverte n'est pas géométriquement parfaite mais imite l'irrégularité naturelle des taches ouvertes des produits en marbre naturel. Le code "lappato macchia aperta" (tache ouverte rodée) correspond à une palette composée de 16 carreaux au format 75cmx150cm (8+8) qui constituent la totalité de la tache ouverte. Le numéro correspondant est imprimé sur le bord de chaque carreau (voir schéma de pose).

Die Kollektion erlaubt die Bildung einer Spiegeloptik mit den Abmessungen 6 m x 3 m (16 verschiedenen Oberflächen 75 x 150). Ideal in weitläufigen Räumen, in denen die Komposition optimal zur Geltung gebracht werden kann. Der Anschluss zwischen den einzelnen Grafikbildern, die den Spiegeleffekt bilden, ist geometrisch nicht perfekt, sondern empfindet die natürliche Unregelmäßigkeit der mit Naturmarmor erzielten Spiegeloptik nach. Die Artikelbezeichnung „gelappt gespiegelt“ entspricht einer Palette mit 16 Fliesen im Format 75 cm x 150 cm (8+8), die das gesamte, gespiegelte Motiv bilden. Jede Fliese ist an der Seite nummeriert (siehe Verlegeplan).

La colección permite crear una mancha abierta de 6m x 3m (16 caras de 75x150) ideal para ambientes amplios donde se puede realzar toda la composición. La unión entre los gráficos que componen la mancha abierta no es geométricamente perfecta, sino que imita la natural irregularidad de las manchas abiertas de los productos de mármol natural. El código «lapeado mancha abierta» corresponde a una paleta compuesta de 16 baldosas de formato 75cmx150cm (8+8) que componen toda la mancha abierta. El número correspondiente está impreso en el borde de cada baldosa (ver diagrama de colocación).

Коллекция позволяет создавать облицовку с симметричным зеркальным рисунком 6 м x 3 м (16 плит 75x150). Данная композиция максимально раскрывает свой потенциал в больших помещениях. Стык между плитками, которые образуют симметричный рисунок, не является геометрически совершенным, а имитирует естественную неровность аналогичных рисунков, составляемых из плит природного мрамора. Код «лаплатированный с симметричным зеркальным рисунком» соответствует поддону, состоящему из 16 плит формата 75 см x 150 см (8+8), из которых складывается данный симметричный рисунок. На торце каждой из плит напечатан соответствующий номер (см. схему укладки).

The miniatures are not in proportion. - I minimali non sono in proporzione. - Les illustrations à échelle réduite ne sont pas proportionnelles. - Die Abbildungen sind nicht verhältnismäßig. - Los miniaturas no están en proporción. n. - Изображения не соблюдают пропорций.

INDEX



PRODUCT FINDER



SURFACE RANGE



COMPANY



COLLECTIONS



- 3D WALL
- CONCRETE & RESIN LOOK
- METAL LOOK
- MARBLE LOOK
- STONE LOOK
- WOOD LOOK

LARGE SIZES



TECHNICAL SPECIFICATIONS



# Marvel Shine

## Porcelain Tiles

### DECOR RANGE

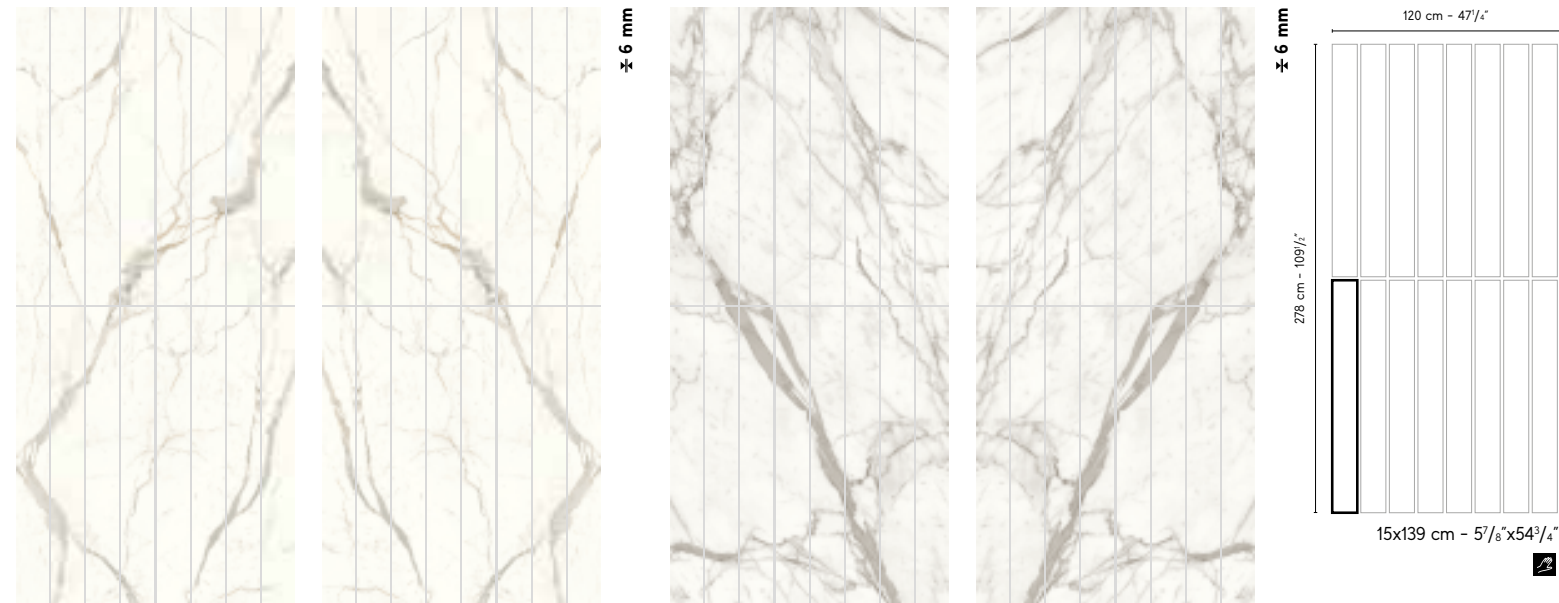

A421 Marvel Calacatta Prestigio Scenic Bookm A Lp ▲ 120x278 - 47 1/4" x 109 1/2"  
 A43L Marvel Calacatta Prestigio Scenic Bookm B Lp ▲ 120x278 - 47 1/4" x 109 1/2"  
 A43O Marvel Statuario Supremo Scenic Bookm A Lp ▲ 120x278 - 47 1/4" x 109 1/2"  
 A43M Marvel Statuario Supremo Scenic Bookm B Lp ▲ 120x278 - 47 1/4" x 109 1/2"



A42Z Marvel Mosaico Match Lapp 29,2x33,7 - 11 1/2" x 13 1/4" ■  
 Calacatta Delicato + Calacatta Prestigio + Blaze Corten + Boost Pro Tobacco

▲ 120x278 cm slabs cut into modules that recombine the open vein. This makes it possible to lay them even on curved surfaces. Each slab is cut into 16 numbered modules measuring 15x139 cm. To recreate the open vein, follow the sequence of pieces indicated in the laying patterns inside the packaging. Each slab is placed in 4 boxes, each of which contains 4 modules, for a total of 16 modules, corresponding to a surface of 3.3 mq. - Lastre 120cmx278cm tagliata in moduli che ricompongono la macchia aperta. Consentono la posa anche su superfici curve. Ogni lastra viene tagliata in 16 moduli numerati, di dimensione 15cmx139cm: per ricreare la macchia aperta seguire la sequenza dei pezzi indicata negli schemi di posa all'interno dell'imballo. Ogni lastra viene collocata in 4 scatole, ciascuna delle quali contiene 4 moduli, per un totale di 16 moduli, corrispondenti ad una superficie di 3,3mq. - Dalles de 120 cm x 278 cm découpées en modules qui reconstituent la tache ouverte. Elles permettent la pose même sur des surfaces courbes. Chaque dalle est découpée en 16 modules numérotés, mesurant 15 cm x 139 cm: pour recréer la tache ouverte, suivez la séquence de pièces indiquée dans les schémas de pose à l'intérieur de l'emballage. Chaque dalle est placée dans 4 boîtes contenant chacune 4 modules, pour un total de 16 modules, correspondant à une surface de 3,3 mètres carrés. - Platten 120 cm x 278 cm, zu Modulen geschnitten, die das gespiegelte Motiv bilden. Die Verlegung ist auch auf gewölbten Oberflächen möglich. Jede Platte wird in 16 nummerierte Module mit Abmessungen 15 cm x 139 cm geschnitten. Um die Spiegeloptik zu erzielen, die auf den die Verpackung beiliegenden Verlegeplänen angegebene Reihenfolge beachten. Jede Platte wird in 4 Schachteln mit je 4 Modulen verpackt. Die insgesamt 16 Module entsprechen einer Oberfläche von 3,3 qm. - Placas 120cmx278cm cortadas en módulos que recomponen la mancha abierta. También permiten la colocación en superficies curvas. Cada losa se corta en 16 módulos numerados que miden 15cmx139cm: para recrear la mancha abierta, se sigue la secuencia de las piezas indicadas en los esquemas de colocación dentro del embalaje. Cada losa se coloca en 4 cajas, cada una de estas contiene 4 módulos por un total de 16 módulos, lo que corresponde a un área de 3,3 metros cuadrados. - Плиты 120 см x 278 см разрезаны на модули, которые впоследствии складываются в симметричный зеркальный рисунок. Также возможна укладка на изогнутые поверхности. Каждая плита разрезается на 16 пронумерованных модулей размером 15 см x 139 см: чтобы заново сложить исходный симметричный рисунок, необходимо соблюдать последовательность, указанную на схемах укладки внутри упаковки. Каждая плита помещается в 4 коробки по 4 модуля, всего - 16 модулей, соответствующих площади 3,3 кв.м.

■ The decoration can only be laid on the wall - Il decoro si può posare solo a rivestimento - Décor uniquement mural - Das Dekor kann nur an der Wand verlegt werden  
 La decoración se puede colocar únicamente en paredes - Декор может быть уложен только на стену.

■ A random laying pattern is recommended. Each box contains 8 elements comprising the composition shown in the figure. - Si consiglia uno schema di posa casuale. Ogni scatola contiene la composizione degli 8 elementi rappresentata in figura. - Un schéma de pose casuelle est conseillé. Chaque boîte contient la composition des 8 éléments indiqués dans l'image. - Es empfiehlt sich die Verlegung nach dem Zufallsprinzip. Jede Schachtel enthält die abgebildete Komposition aus den 8 Elementen. - Se recomienda un esquema aleatorio de colocación. Cada caja contiene la composición de los 8 elementos que se muestran en la figura. - Рекомендуется произвольная схема укладки. Каждая коробка содержит композицию из 8 элементов, показанную на рисунке.

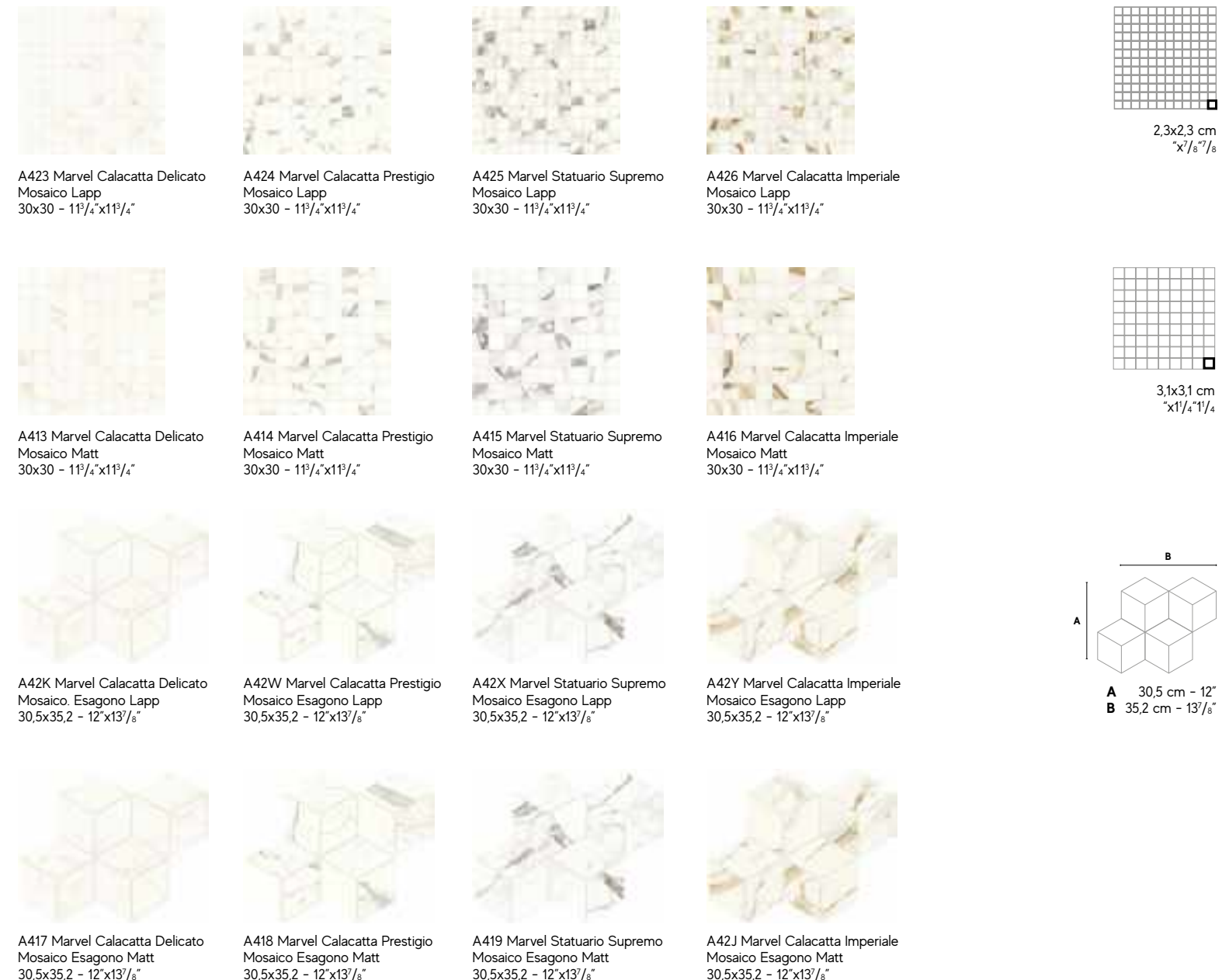

A423 Marvel Calacatta Delicato Mosaico Lapp 30x30 - 11 3/4" x 11 3/4"  
 A424 Marvel Calacatta Prestigio Mosaico Lapp 30x30 - 11 3/4" x 11 3/4"  
 A425 Marvel Statuario Supremo Mosaico Lapp 30x30 - 11 3/4" x 11 3/4"  
 A426 Marvel Calacatta Imperiale Mosaico Lapp 30x30 - 11 3/4" x 11 3/4"  
 A413 Marvel Calacatta Delicato Mosaico Matt 30x30 - 11 3/4" x 11 3/4"  
 A414 Marvel Calacatta Prestigio Mosaico Matt 30x30 - 11 3/4" x 11 3/4"  
 A415 Marvel Statuario Supremo Mosaico Matt 30x30 - 11 3/4" x 11 3/4"  
 A416 Marvel Calacatta Imperiale Mosaico Matt 30x30 - 11 3/4" x 11 3/4"  
 A42K Marvel Calacatta Delicato Mosaico Esagono Lapp 30,5x35,2 - 12" x 13 7/8"  
 A42W Marvel Calacatta Prestigio Mosaico Esagono Lapp 30,5x35,2 - 12" x 13 7/8"  
 A42X Marvel Statuario Supremo Mosaico Esagono Lapp 30,5x35,2 - 12" x 13 7/8"  
 A42Y Marvel Calacatta Imperiale Mosaico Esagono Lapp 30,5x35,2 - 12" x 13 7/8"  
 A417 Marvel Calacatta Delicato Mosaico Esagono Matt 30,5x35,2 - 12" x 13 7/8"  
 A418 Marvel Calacatta Prestigio Mosaico Esagono Matt 30,5x35,2 - 12" x 13 7/8"  
 A419 Marvel Statuario Supremo Mosaico Esagono Matt 30,5x35,2 - 12" x 13 7/8"  
 A42J Marvel Calacatta Imperiale Mosaico Esagono Matt 30,5x35,2 - 12" x 13 7/8"

INDEX



PRODUCT FINDER



SURFACE RANGE



COMPANY



COLLECTIONS



- 3D WALL
- CONCRETE & RESIN LOOK
- METAL LOOK
- MARBLE LOOK
- STONE LOOK
- WOOD LOOK

LARGE SIZES



TECHNICAL SPECIFICATIONS



# Marvel Shine Wall Tiles

## SILK SURFACE



± 8,5 mm

50x120 cm - 19<sup>5</sup>/<sub>8</sub>"x47<sup>1</sup>/<sub>4</sub>"

- A4TT Marvel Calacatta Delicato Silk
- A4TU Marvel Calacatta Prestigio Silk
- A4TV Marvel Statuario Supremo Silk
- A4TW Marvel Calacatta Imperiale Silk

## SHINY SURFACE



± 8,5 mm

40x80 cm - 15<sup>3</sup>/<sub>4</sub>"x31<sup>1</sup>/<sub>2</sub>"

- A3ZS Marvel Calacatta Delicato Shiny
- A3ZT Marvel Calacatta Prestigio Shiny
- A3ZU Marvel Statuario Supremo Shiny
- A3ZV Marvel Calacatta Imperiale Shiny

## TRIM TILES

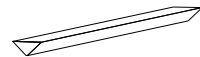

1,4x50 cm - 5<sup>5</sup>/<sub>8</sub>"x19<sup>5</sup>/<sub>8</sub>"

- A41D Marvel Calacatta Delicato Corner 50 Silk \*
- A41E Marvel Calacatta Prestigio Corner 50 Silk \*
- A41F Marvel Statuario Supremo Corner 50 Silk \*
- A41G Marvel Calacatta Imperiale Corner 50 Silk \*

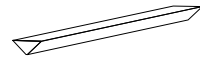

1,4x40 cm - 5<sup>5</sup>/<sub>8</sub>"x15<sup>3</sup>/<sub>4</sub>"

- A41H Marvel Calacatta Delicato Corner 40 Shiny \*
- A41I Marvel Calacatta Prestigio Corner 40 Shiny \*
- A41J Marvel Statuario Supremo Corner 40 Shiny \*
- A41K Marvel Calacatta Imperiale Corner 40 Shiny \*



1,4x1,4 cm - 5<sup>5</sup>/<sub>8</sub>"x5<sup>5</sup>/<sub>8</sub>"

- A41L Marvel Calacatta Delicato Corner A.E. \*
- A41M Marvel Calacatta Prestigio Corner A.E. \*
- A41N Marvel Statuario Supremo Corner A.E. \*
- A41O Marvel Calacatta Imperiale Corner A.E. \*

\* These parts are supplied to order - I pezzi sono disponibili su ordinazione - Les pièces sont disponibles sur commande - Die Teile sind auf Bestellung lieferbar - Las piezas se hacen por encargo - Изготавливаются на заказ

\* Calacatta Delicato, Calacatta Prestigio, Statuario Supremo

\*\* Calacatta Imperiale

Shiny surface - Superficie lucida - Surface brillante - Glänzende Oberfläche - Superficie brillante - Глянцевая поверхность

Silk surface - Superficie silk - Surface Silk - Silk Oberfläche - Superficie Silk - Поверхность Silk



## DECOR RANGE



A4WK Marvel Calacatta Delicato Mosaico Twist Shiny 30,5x30,5 - 12"x12"



A4WL Marvel Calacatta Prestigio Mosaico Twist Shiny 30,5x30,5 - 12"x12"



A4WM Marvel Statuario Supremo Mosaico Twist Shiny 30,5x30,5 - 12"x12"



A4WN Marvel Calacatta Imperiale Mosaico Twist Shiny 30,5x30,5 - 12"x12"



A4WO Marvel Calacatta Delicato Mosaico Twist Silk 30,5x30,5 - 12"x12"



A4WP Marvel Calacatta Prestigio Mosaico Twist Silk 30,5x30,5 - 12"x12"



A4WQ Marvel Statuario Supremo Mosaico Twist Silk 30,5x30,5 - 12"x12"



A4WR Marvel Calacatta Imperiale Mosaico Twist Silk 30,5x30,5 - 12"x12"



A4WT Marvel Calacatta Delicato Gold Hex Shiny • 25,1x29 - 9<sup>7</sup>/<sub>8</sub>"x11<sup>1</sup>/<sub>8</sub>"



A4WU Marvel Calacatta Prestigio Gold Hex Shiny • 25,1x29 - 9<sup>7</sup>/<sub>8</sub>"x11<sup>1</sup>/<sub>8</sub>"



A4WV Marvel Statuario Supremo Platino Hex Shiny • 25,1x29 - 9<sup>7</sup>/<sub>8</sub>"x11<sup>1</sup>/<sub>8</sub>"



A4WW Marvel Calacatta Imperiale Gold Hex Shiny • 25,1x29 - 9<sup>7</sup>/<sub>8</sub>"x11<sup>1</sup>/<sub>8</sub>"



A4WS Marvel Calacatta Prestigio Rose Hex Silk • 25,1x29 - 9<sup>7</sup>/<sub>8</sub>"x11<sup>1</sup>/<sub>8</sub>"

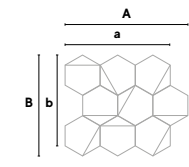
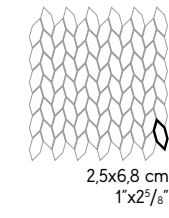

A 33,9 cm - 13<sup>3</sup>/<sub>8</sub>"  
a 29 cm - 11<sup>1</sup>/<sub>8</sub>"  
B 27,9 cm - 11"  
b 25,1 cm - 9<sup>7</sup>/<sub>8</sub>"

• Decor with Gold insert - Decoro con inserto in oro - Décor avec insert en or - Dekor mit Goldeinlage - Decoración con aplicación de oro - Декор с золотой вставкой.

INDEX



PRODUCT  
FINDER



SURFACE  
RANGE



COMPANY



COLLECTIONS



- 3D WALL
- CONCRETE & RESIN LOOK
- METAL LOOK
- MARBLE LOOK
- STONE LOOK
- WOOD LOOK

LARGE SIZES



TECHNICAL  
SPECIFICATIONS



# Marvel Stone

DOWNLOAD >  
CATALOG &  
IMAGE GALLERY

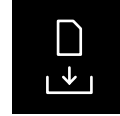

ENJOY THE  
VIDEO

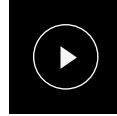

© Ceramiche Atlas Concorde



© Ceramiche Atlas Concorde



© Ceramiche Atlas Concorde

## Porcelain Tiles

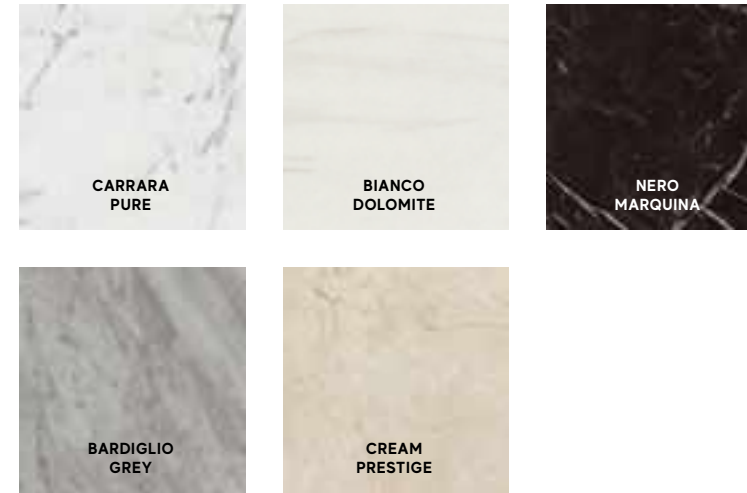

### COLOURED BODY PORCELAIN TILES - RECTIFIED MONOCALIBER

Sizes	Thickness	Surface finish
162x324 cm - 63 <sup>1</sup> / <sub>4</sub> "x127 <sup>1</sup> / <sub>2</sub> " NON RECTIFIED	± 6-12-20* mm	Polished   Silk   Satin
160x320 cm - 63"x126"	± 6 mm	Polished
160x160 cm - 63"x63"	± 6 mm	Polished
120x278 cm - 47 <sup>1</sup> / <sub>4</sub> "x109 <sup>1</sup> / <sub>2</sub> "	± 6 mm	Polished   Matte R9 A
120x240 cm - 47 <sup>1</sup> / <sub>4</sub> "x94 <sup>1</sup> / <sub>2</sub> "	± 9 mm	Polished
120x120 cm - 47 <sup>1</sup> / <sub>4</sub> "x47 <sup>1</sup> / <sub>4</sub> "	± 9 mm	Polished   Matte R9 A
60x120 cm - 23 <sup>3</sup> / <sub>8</sub> "x47 <sup>1</sup> / <sub>4</sub> "	± 9 mm	Polished   Matte R9 A
75x150 cm - 29 <sup>1</sup> / <sub>2</sub> "x59"	± 9 mm	Polished
75x75 cm - 29 <sup>1</sup> / <sub>2</sub> "x29 <sup>1</sup> / <sub>2</sub> "	± 9 mm	Polished
45x90 cm - 17 <sup>3</sup> / <sub>8</sub> "x35 <sup>3</sup> / <sub>8</sub> "	± 9 mm	Polished   Matte R9 A
60x60 cm - 23 <sup>3</sup> / <sub>8</sub> "x23 <sup>3</sup> / <sub>8</sub> "	± 9 mm	Polished   Matte R9 A
30x60 cm - 11 <sup>1</sup> / <sub>4</sub> "x23 <sup>3</sup> / <sub>8</sub> "	± 9 mm	Polished   Matte R9 A

LARGE SIZES p. 390

MARVEL STONE COLLECTION STONE LOOK p. 332

## Wall Tiles

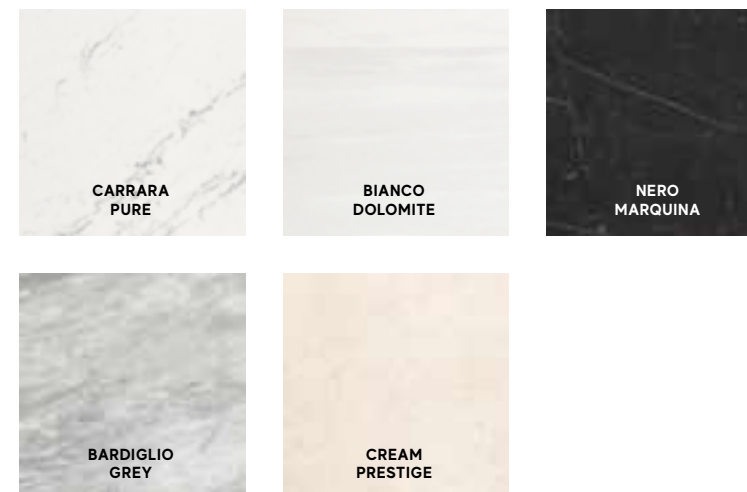

### WHITEBODY WALL TILES - RECTIFIED MONOCALIBER

Sizes	Thickness	Surface finish
50x120 cm - 19 <sup>5</sup> / <sub>8</sub> "x47 <sup>1</sup> / <sub>4</sub> "	± 8,5 mm	Shiny
40x80 cm - 15 <sup>1</sup> / <sub>4</sub> "x31 <sup>1</sup> / <sub>2</sub> "	± 8,5 mm	Shiny
8x31,5 cm - 3 <sup>1</sup> / <sub>8</sub> "x12 <sup>3</sup> / <sub>8</sub> "	± 8,5 mm	Shiny

Coloured body porcelain tiles – Gres porcellanato colorato in massa – Grès cérame coloré dans la masse – Durchgefärbtes Feinsteinzeug – Gres porcelánico coloreado en masa – Керамический гранит окрашенный в массу  
 Whitebody wall tiles – Rivestimenti in pasta bianca – Revêtements en pâte blanche – Weißscherbige Wandfliesen – Revestimientos en pasta blanca – Настенная плитка из белой глины  
 Rectified monocaliber – Rettificato monocalibro – Rectifié mono-calibre – Geschliffen einkalbrig – Rectificado monocalibre – Ретифицированный в одном калибре  
 Non rectified – Non rettificato – Non rectifié – Nicht rektifiziert – No rectificada – Неретифицированные

INDEX



PRODUCT  
FINDER



SURFACE  
RANGE



COMPANY



COLLECTIONS



- 3D WALL
- CONCRETE & RESIN LOOK
- METAL LOOK
- MARBLE LOOK
- STONE LOOK
- WOOD LOOK

LARGE SIZES



TECHNICAL  
SPECIFICATIONS



# Marvel Stone

## Porcelain Tiles

### POLISHED SURFACE

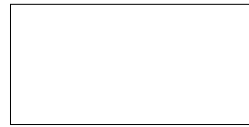

± 6 mm  
**160x320 cm** - 63"x126"  
 AO5X Marvel Bianco Dolomite Lapp



± 6 mm  
**160x160 cm** - 63"x63"  
 AO53 Marvel Bianco Dolomite Lapp



± 6 mm  
**120x278 cm** - 47 1/4"x109 1/2"  
 AØBP Marvel Bianco Dolomite Lapp  
 A2RW Marvel Carrara Pure Lapp



± 9 mm  
**120x240 cm** - 47 1/4"x94 1/2"  
 AZTV Marvel Bianco Dolomite Lapp  
 AZTW Marvel Carrara Pure Lapp



± 9 mm  
**120x120 cm** - 47 1/4"x47 1/4"  
 AZTT Marvel Bianco Dolomite Lapp  
 AZTU Marvel Carrara Pure Lapp



± 9 mm  
**60x120 cm** - 23 3/8"x47 1/4"  
 AZ1K Marvel Bianco Dolomite Lapp  
 AKSØ Marvel Carrara Pure Lapp



± 9 mm  
**60x60 cm** - 23 3/8"x23 3/8"  
 AZRI Marvel Bianco Dolomite Lapp  
 AZRJ Marvel Cream Prestige Lapp  
 AZRK Marvel Bardiglio Grey Lapp  
 AZRL Marvel Carrara Pure Lapp  
 AZRM Marvel Nero Marquina Lapp



± 9 mm  
**30x60 cm** - 11 3/4"x23 3/8"  
 DØ39 Marvel Bianco Dolomite Lapp  
 DØ4Ø Marvel Cream Prestige Lapp  
 DØ41 Marvel Bardiglio Grey Lapp  
 DØ44 Marvel Carrara Pure Lapp  
 DØ45 Marvel Nero Marquina Lapp



± 9 mm  
**75x150 cm** - 29 1/2"x59"  
 A7GE Marvel Bianco Dolomite Lapp  
 A7GF Marvel Cream Prestige Lapp  
 A7GG Marvel Bardiglio Grey Lapp  
 A7GH Marvel Carrara Pure Lapp  
 A7GI Marvel Nero Marquina Lapp



± 9 mm  
**75x75 cm** - 29 1/2"x29 1/2"  
 AZNH Marvel Bianco Dolomite Lapp  
 AZNI Marvel Cream Prestige Lapp  
 AZNJ Marvel Bardiglio Grey Lapp  
 AZNK Marvel Carrara Pure Lapp  
 AZNL Marvel Nero Marquina Lapp



± 9 mm  
**45x90 cm** - 17 3/4"x35 3/8"  
 AZRU Marvel Bianco Dolomite Lapp  
 AZRV Marvel Cream Prestige Lapp  
 AZRW Marvel Bardiglio Grey Lapp  
 AZRX Marvel Carrara Pure Lapp  
 AZRY Marvel Nero Marquina Lapp



Polished ± 6 mm  
 Polished ± 9 mm



V2 Slight  
 Variation



atlasPLAN  
 p. 390



**POLISHED**  
**162x324 cm** - 63 3/4"x127 1/2"  
 NON RECTIFIED



BIANCO DOLOMITE



CARRARA PURE



CREAM PRESTIGE



BARDIGLIO GREY

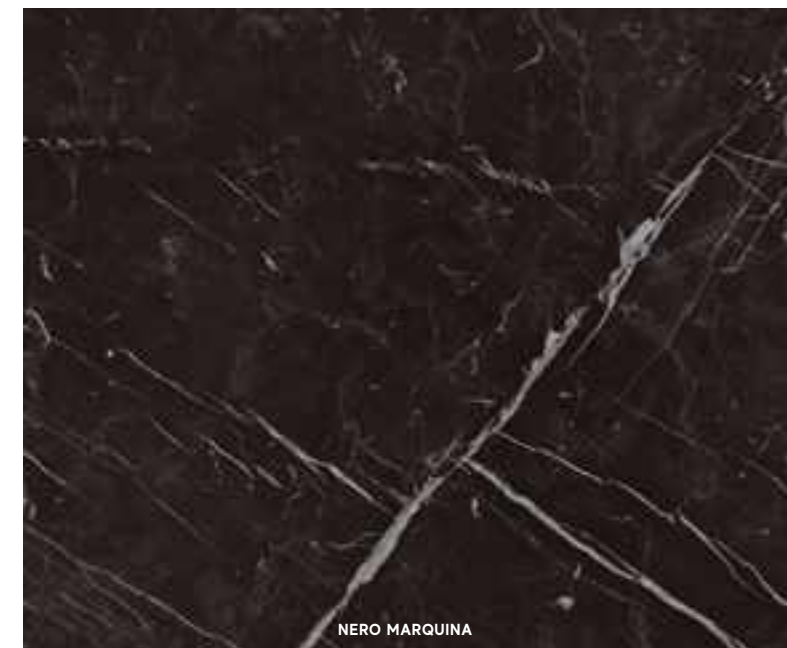

NERO MARQUINA

**A polished finish is recommended for low-stress residential or commercial floors where anti-slip performance is not required. The surface's shine and superior ease of cleaning are the result of in-depth studies and extensive technical research aimed at ensuring its durability over time. If the product is in direct contact with the outside, use moisture and dirt absorption devices to prevent scratches.** - La finitura lappata è indicata per pavimenti residenziali o commerciali poco sollecitati, laddove non siano richieste prestazioni antiscivolo. La lucentezza e l'elevata facilità di pulizia della superficie sono frutto di studi approfonditi e accurate ricerche tecniche volte a garantirne la persistenza nel tempo. Se il prodotto è a diretto contatto con l'esterno, prevedere dei dispositivi di assorbimento dell'umidità e dello sporco per prevenire la formazione di graffi. - La finition semi-polie est indiquée pour les sols résidentiels ou commerciaux à faibles contraintes, où la performance antidérapante n'est pas requise. La brillance et la grande facilité de nettoyage de la surface sont le résultat d'études approfondies et de recherches techniques visant à assurer sa persistance dans le temps. Si le produit est en contact direct avec l'extérieur, prévoyez des dispositifs d'absorption de l'humidité et des poussières pour éviter la formation de rayures. - Die Oberflächenversion Geläpft eignet sich für Bodenbeläge in Wohnbereichen bzw. in gering beanspruchten Gewerberäumen, wenn keine Rutschfestigkeit erforderlich ist. Der Glanz und die einfache Reinigung der Oberfläche sind das Resultat eingehender technischer Studien, mit denen die langfristige Beständigkeit sichergestellt wurde. Kommt das Produkt direkt mit der externen Umgebung in Kontakt, so sind Feuchtigkeit und Schmutz mit geeigneten Mitteln aufzunehmen, um Kratzer zu vermeiden. - El acabado lapedo es adecuado para pavimentos residenciales o comerciales con poco tráfico, donde no se requiere un efecto antideslizante. El brillo y la gran facilidad de limpieza de la superficie son el resultado de profundos estudios e investigaciones técnicas precisas para asegurar su persistencia en el tiempo. Si el producto está en contacto directo con el exterior, proporcionar dispositivos de absorción de humedad y suciedad para evitar arañazos. - Лаппатированная поверхность рекомендована для полов жилых и коммерческих помещений с невысокой интенсивностью эксплуатации, в которых от покрытий не требуется характеристик сопротивления скольжению. Блеск и легкая очистка являются результатом глубоких исследований, направленных на создание долговечного материала. Если плитка находится в непосредственном контакте с наружной средой, необходимо предусмотреть устройства поглощения влаги и грязи во избежание образования царапин.

**Polished surface** - Superficie lappata - Surface adouci - Geläppte Oberfläche - Superficie brulido - Полуполированный поверхность

INDEX



PRODUCT  
 FINDER



SURFACE  
 RANGE



COMPANY



COLLECTIONS



- 3D WALL
- CONCRETE & RESIN LOOK
- METAL LOOK
- MARBLE LOOK
- STONE LOOK
- WOOD LOOK

LARGE SIZES



TECHNICAL  
 SPECIFICATIONS





# Marvel Stone

## Porcelain Tiles

### MATTE SURFACE

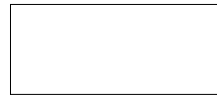

± 6 mm  
**120x278 cm** - 47<sup>1</sup>/<sub>4</sub>"x109<sup>1</sup>/<sub>2</sub>"  
 A2RS Marvel Bianco Dolomite Matt  
 A2RV Marvel Carrara Pure Matt



± 9 mm  
**120x120 cm** - 47<sup>1</sup>/<sub>4</sub>"x47<sup>1</sup>/<sub>4</sub>"  
 A2Ø4 Marvel Bianco Dolomite Matt  
 A2Ø7 Marvel Carrara Pure Matt



± 9 mm  
**60x120 cm** - 23<sup>5</sup>/<sub>8</sub>"x47<sup>1</sup>/<sub>4</sub>"  
 A21C Marvel Bianco Dolomite Matt  
 A21E Marvel Carrara Pure Matt



± 9 mm  
**60x60 cm** - 23<sup>5</sup>/<sub>8</sub>"x23<sup>5</sup>/<sub>8</sub>"  
 AZQS Marvel Bianco Dolomite Matt  
 AZQT Marvel Cream Prestige Matt  
 AZQU Marvel Bardiglio Grey Matt  
 AZQV Marvel Carrara Pure Matt  
 AZQW Marvel Nero Marquina Matt



± 9 mm  
**30x60 cm** - 11<sup>3</sup>/<sub>4</sub>"x23<sup>5</sup>/<sub>8</sub>"  
 D11Ø Marvel Bianco Dolomite Matt  
 D111 Marvel Cream Prestige Matt  
 D112 Marvel Bardiglio Grey Matt  
 D113 Marvel Carrara Pure Matt  
 D114 Marvel Nero Marquina Matt



± 9 mm  
**45x90 cm** - 17<sup>3</sup>/<sub>4</sub>"x35<sup>3</sup>/<sub>8</sub>"  
 AZRZ Marvel Bianco Dolomite Matt  
 AZRØ Marvel Cream Prestige Matt  
 AZR1 Marvel Bardiglio Grey Matt  
 AZR3 Marvel Carrara Pure Matt  
 AZR4 Marvel Nero Marquina Matt



Matte ± 6 mm



Matte ± 9 mm



R9 A Matte ± 6 mm  
 R9 A Matte ± 9 mm



atlasPLAN  
 p. 390



**SILK / SATIN**  
**162x324 cm** - 63<sup>3</sup>/<sub>4</sub>"x127<sup>1</sup>/<sub>2</sub>"  
 NON RECTIFIED



BIANCO DOLOMITE



CARRARA PURE



CREAM PRESTIGE



BARDIGLIO GREY



NERO MARQUINA

TRIM TILES p. 462	Battiscopa				Gradino *	Scalino *	Scalin Ang.*	Battiscopa Sag. Scala *	
	Matt	Lapp	Matt	Lapp				DX	SX
UPECE p. 455	72x60 cm 2 <sup>7</sup> / <sub>8</sub> "x23 <sup>5</sup> / <sub>8</sub> "		Digitale 46x60 cm 1 <sup>7</sup> / <sub>8</sub> "x23 <sup>5</sup> / <sub>8</sub> "		30x60 cm 11 <sup>3</sup> / <sub>4</sub> "x23 <sup>5</sup> / <sub>8</sub> " Matt	33x60 cm 13"x23 <sup>5</sup> / <sub>8</sub> " Matt	33x33 cm 13"x13" Matt	72x30 cm 2 <sup>7</sup> / <sub>8</sub> "x11 <sup>3</sup> / <sub>4</sub> " Matt	
	ATDT	ATDO	ATDJ	ATDE	ATDY	ATD3	ATEE	ATEO	ATEJ
	ATDU	ATDP	ATDK	ATDF	ATDZ	ATD4	ATEF	ATEP	ATEK
	ATDV	ATDQ	ATDL	ATDG	ATDØ	ATD5	ATEG	ATEQ	ATEL
	ATDW	ATDR	ATDM	ATDH	ATD1	ATD6	ATEH	ATER	ATEM
	ATDX	ATDS	ATDN	ATDI	ATD2	ATEI	ATES	ATEN	

\* These parts are supplied to order - I pezzi sono disponibili su ordinazione - Les pièces sont disponibles sur commande - Die Teile sind auf Bestellung lieferbar - Las piezas se hacen por encargo - Изготавливаются на заказ

Matte surface - Superficie matt - Surface Mat - Matte Oberfläche - Superficie Mate - Матовая поверхность

INDEX



PRODUCT  
FINDER



SURFACE  
RANGE



COMPANY



COLLECTIONS



- 3D WALL
- CONCRETE & RESIN LOOK
- METAL LOOK
- MARBLE LOOK
- STONE LOOK
- WOOD LOOK

LARGE SIZES



TECHNICAL  
SPECIFICATIONS



# Marvel Stone

## Porcelain Tiles

### DECOR RANGE

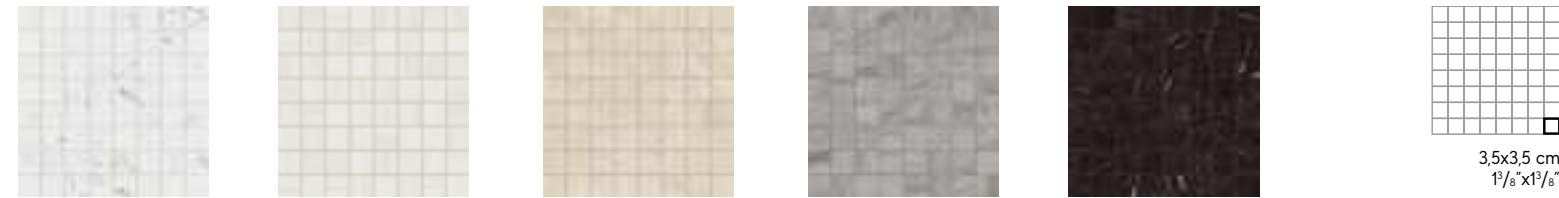

AS3Y Marvel Carrara Pure Mosaico Matt 30x30 - 1 1/4" x 1 1/4"  
 AS3V Marvel Bianco Dolomite Mosaico Matt 30x30 - 1 1/4" x 1 1/4"  
 AS3W Marvel Cream Prestige Mosaico Matt 30x30 - 1 1/4" x 1 1/4"  
 AS3X Marvel Bardiglio Grey Mosaico Matt 30x30 - 1 1/4" x 1 1/4"  
 AS3Z Marvel Nero Marquina Mosaico Matt 30x30 - 1 1/4" x 1 1/4"

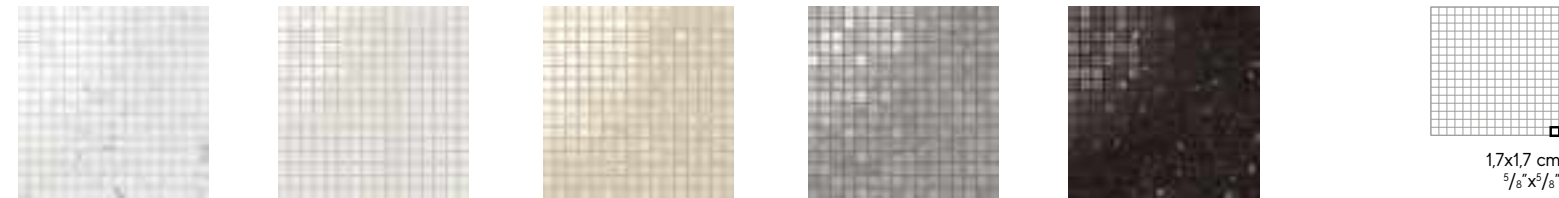

AS3T Marvel Carrara Pure Mosaico Lappato 30x30 - 1 1/4" x 1 1/4"  
 AS2T Marvel Bianco Dolomite Mosaico Lappato 30x30 - 1 1/4" x 1 1/4"  
 AS3Q Marvel Cream Prestige Mosaico Lappato 30x30 - 1 1/4" x 1 1/4"  
 AS3S Marvel Bardiglio Grey Mosaico Lappato 30x30 - 1 1/4" x 1 1/4"  
 AS3U Marvel Nero Marquina Mosaico Lappato 30x30 - 1 1/4" x 1 1/4"



AS2J Marvel Carrara Pure Mosaico Esagono Lappato 30x35 - 1 1/4" x 1 3/4"  
 AS2G Marvel Bianco Dolomite Mosaico Esagono Lappato 30x35 - 1 1/4" x 1 3/4"  
 AS2H Marvel Cream Prestige Mosaico Esagono Lappato 30x35 - 1 1/4" x 1 3/4"  
 AS2I Marvel Bardiglio Grey Mosaico Esagono Lappato 30x35 - 1 1/4" x 1 3/4"  
 AS2K Marvel Nero Marquina Mosaico Esagono Lappato 30x35 - 1 1/4" x 1 3/4"

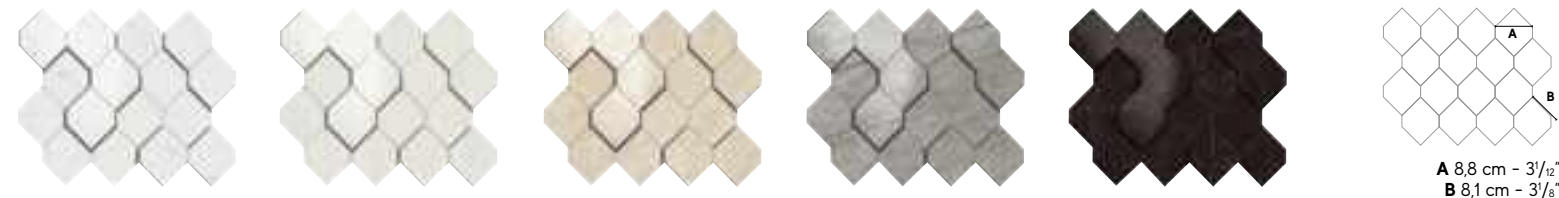

AS4A Marvel Carrara Pure Mosaico Esagono 3D 28,2x35,3 - 11"x14"  
 AS36 Marvel Bianco Dolomite Mosaico Esagono 3D 28,2x35,3 - 11"x14"  
 AS38 Marvel Cream Prestige Mosaico Esagono 3D 28,2x35,3 - 11"x14"  
 AS39 Marvel Bardiglio Grey Mosaico Esagono 3D 28,2x35,3 - 11"x14"  
 AS4B Marvel Nero Marquina Mosaico Esagono 3D 28,2x35,3 - 11"x14"



AS34 Marvel Carrara Pure Mosaico Lappato Burattato 29,8x29,8 - 1 1/8" x 1 1/8"  
 AS31 Marvel Bianco Dolomite Mosaico Lappato Burattato 29,8x29,8 - 1 1/8" x 1 1/8"  
 AS32 Marvel Cream Prestige Mosaico Lappato Burattato 29,8x29,8 - 1 1/8" x 1 1/8"  
 AS33 Marvel Bardiglio Grey Mosaico Lappato Burattato 29,8x29,8 - 1 1/8" x 1 1/8"  
 AS35 Marvel Nero Marquina Mosaico Lappato Burattato 29,8x29,8 - 1 1/8" x 1 1/8"

The decoration can only be laid on the wall - Il decoro si può posare solo a rivestimento - Décor uniquement mural - Das Dekor kann nur an der Wand verlegt werden - La decoración se puede colocar únicamente en paredes - Декор может быть уложен только на стену.



AS1V Marvel Carrara Pure Chevron Lappato 22,5x22,9 - 8 7/8" x 9"  
 AS1Q Marvel Bianco Dolomite Chevron Lappato 22,5x22,9 - 8 7/8" x 9"  
 AS1R Marvel Cream Prestige Chevron Lappato 22,5x22,9 - 8 7/8" x 9"  
 AS1U Marvel Bardiglio Grey Chevron Lappato 22,5x22,9 - 8 7/8" x 9"  
 AS1W Marvel Nero Marquina Chevron Lappato 22,5x22,9 - 8 7/8" x 9"  
 AS2F Marvel Chevron Cold Lappato 22,5x22,9 - 8 7/8" x 9" Carrara Pure + Nero Marquina

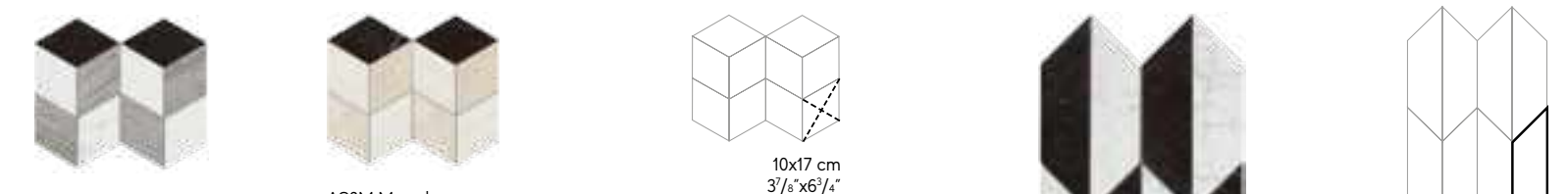

AS2L Marvel Mosaico Esagono Geo Cold Lappato 25,4x35,2 - 10"x13 3/4" Carrara Pure + Bardiglio Grey + Nero Marquina  
 AS2M Marvel Mosaico Esagono Geo Warm Lappato 25,4x35,2 - 10"x13 3/4" Bianco Dolomite + Cream Prestige + Nero Marquina

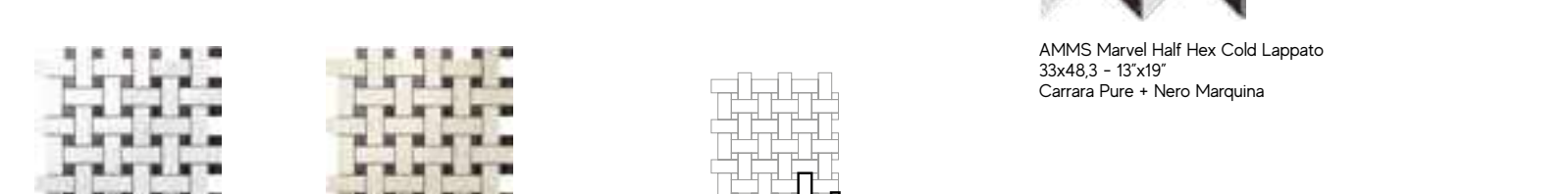

AS2O Marvel Basketweave Cold Lappato 30x30 - 1 1/4" x 1 1/4" Carrara Pure + Nero Marquina  
 AS2P Marvel Basketweave Warm Lappato 30x30 - 1 1/4" x 1 1/4" Cream Prestige + Nero Marquina



AS4W Marvel Carrara Pure Listello Lappato 7x60 - 2 3/4" x 23 3/8"  
 AS41 Marvel Carrara Pure Angolo Lappato 7x7 - 2 3/4" x 2 3/4"



AS4T Marvel Bianco Dolomite Listello Lappato 7x60 - 2 3/4" x 23 3/8"  
 AS4Y Marvel Bianco Dolomite Angolo Lappato 7x7 - 2 3/4" x 2 3/4"

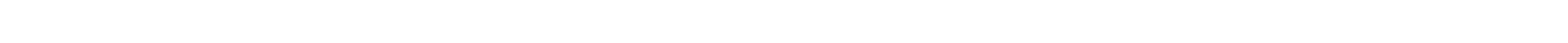

AS4U Marvel Cream Prestige Listello Lappato 7x60 - 2 3/4" x 23 3/8"  
 AS4Z Marvel Cream Prestige Angolo Lappato 7x7 - 2 3/4" x 2 3/4"

INDEX

PRODUCT FINDER

SURFACE RANGE

COMPANY

COLLECTIONS

- 3D WALL
- CONCRETE & RESIN LOOK
- METAL LOOK
- MARBLE LOOK
- STONE LOOK
- WOOD LOOK

LARGE SIZES

TECHNICAL SPECIFICATIONS

# Marvel Stone Wall Tiles

## SHINY SURFACE



± 8,5 mm  
**50x120 cm** - 19<sup>5</sup>/<sub>8</sub>"x47<sup>1</sup>/<sub>4</sub>"  
 A4S3 Marvel Carrara Pure  
 A4S4 Marvel Bianco Dolomite  
 A4S5 Marvel Cream Prestige  
 A4S6 Marvel Bardiglio Grey  
 A4S7 Marvel Nero Marquina



± 8,5 mm  
**40x80 cm** - 15<sup>3</sup>/<sub>4</sub>"x31<sup>1</sup>/<sub>2</sub>"  
 9MSF Marvel Carrara Pure  
 9MSB Marvel Bianco Dolomite  
 9MSI Marvel Cream Prestige  
 9MSD Marvel Bardiglio Grey  
 9MSM Marvel Nero Marquina

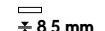

± 8,5 mm  
**8x31,5 cm** - 3<sup>1</sup>/<sub>8</sub>"x12<sup>3</sup>/<sub>8</sub>"  
 AZA2 Carrara Pure Brick

## TRIM TILES



LSLH Carrara Pure London  
 5x30,5 - 2"x12"



ALSF Carrara Pure London A.E.  
 5x2,5 - 2"x1"

LSSA Carrara Pure Spigolo  
 0,8x20 - 3<sup>1</sup>/<sub>8</sub>"x7<sup>1</sup>/<sub>8</sub>"



AS1A Carrara Pure Spigolo A.E.  
 0,8x0,8 - 3<sup>1</sup>/<sub>8</sub>"x3<sup>1</sup>/<sub>8</sub>"

LSLM Bianco Dolomite London  
 5x30,5 - 2"x12"



ALSD Bianco Dolomite London A.E.  
 5x2,5 - 2"x1"

LSSD Bianco Dolomite Spigolo  
 0,8x20 - 3<sup>1</sup>/<sub>8</sub>"x7<sup>1</sup>/<sub>8</sub>"



AS1D Bianco Dolomite Spigolo A.E.  
 0,8x0,8 - 3<sup>1</sup>/<sub>8</sub>"x3<sup>1</sup>/<sub>8</sub>"

LSLE Cream Prestige London  
 5x30,5 - 2"x12"



ALSE Cream Prestige London A.E.  
 5x2,5 cm - 2"x1"

LSSE Cream Prestige Spigolo  
 0,8x20 - 3<sup>1</sup>/<sub>8</sub>"x7<sup>1</sup>/<sub>8</sub>"



AS1E Cream Prestige Spigolo A.E.  
 0,8x0,8 - 3<sup>1</sup>/<sub>8</sub>"x3<sup>1</sup>/<sub>8</sub>"

LSLO Bardiglio Grey London  
 5x30,5 - 2"x12"



ALSG Bardiglio Grey London A.E.  
 5x2,5 - 2"x1"

LSSB Bardiglio Grey Spigolo  
 0,8x20 - 3<sup>1</sup>/<sub>8</sub>"x7<sup>1</sup>/<sub>8</sub>"



AS1G Bardiglio Grey Spigolo A.E.  
 0,8x0,8 - 3<sup>1</sup>/<sub>8</sub>"x3<sup>1</sup>/<sub>8</sub>"

LSLN Nero Marquina London  
 5x30,5 - 2"x12"



ALSN Nero Marquina London A.E.  
 5x2,5 - 2"x1"

LSSN Nero Marquina Spigolo  
 0,8x20 - 3<sup>1</sup>/<sub>8</sub>"x7<sup>1</sup>/<sub>8</sub>"



AS1N Nero Marquina Spigolo A.E.  
 0,8x0,8 - 3<sup>1</sup>/<sub>8</sub>"x3<sup>1</sup>/<sub>8</sub>"

Shiny surface - Superficie lucida - Surface brillante - Glänzende Oberfläche - Superficie brillante - Глянцевая поверхность



CARRARA PURE



BIANCO DOLOMITE



CREAM PRESTIGE



BARDIGLIO GREY

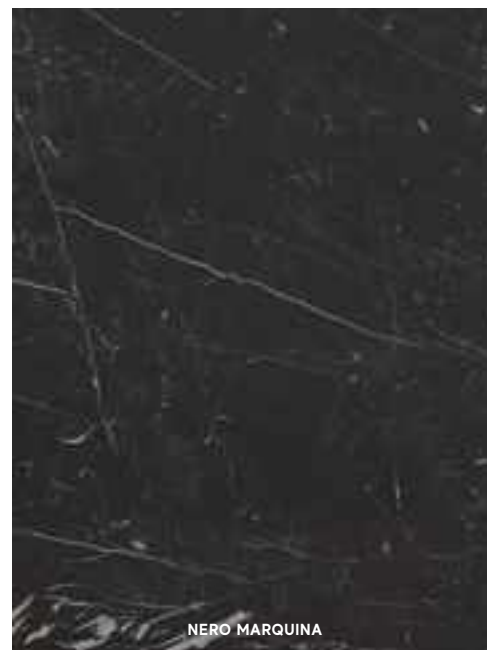

NERO MARQUINA

## DECOR RANGE



9MQC Carrara Pure Mosaic Q  
 30,5x30,5 - 12"x12"

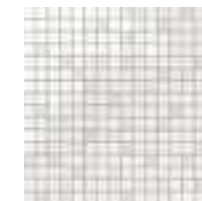

9MQB Bianco Dolomite Mosaic Q  
 30,5x30,5 - 12"x12"



9MQE Cream Prestige Mosaic Q  
 30,5x30,5 - 12"x12"



9MQA Bardiglio Grey Mosaic Q  
 30,5x30,5 - 12"x12"

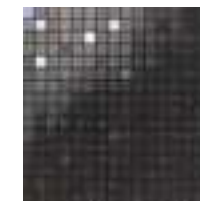

9MQN Nero Marquina Mosaic Q  
 30,5x30,5 - 12"x12"

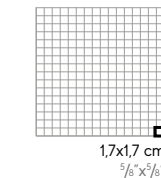

1,7x1,7 cm  
 3/8"x3/8"



9SHC Carrara Pure Herringbone Wall  
 30,5x30 - 12"x11<sup>1</sup>/<sub>4</sub>"



9SHD Bianco Dolomite Herringbone Wall  
 30,5x30 - 12"x11<sup>1</sup>/<sub>4</sub>"



9SHE Cream Prestige Herringbone Wall  
 30,5x30 - 12"x11<sup>1</sup>/<sub>4</sub>"



9SHB Bardiglio Grey Herringbone Wall  
 30,5x30 - 12"x11<sup>1</sup>/<sub>4</sub>"



9SHN Nero Marquina Herringbone Wall  
 30,5x30 - 12"x11<sup>1</sup>/<sub>4</sub>"

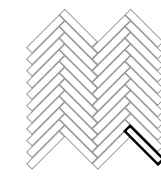

1,7x10,6 cm  
 5/8"x4 1/8"



9STA Carrara Pure Twist  
 30,5x30,5 - 12"x12"



9STD Bianco Dolomite Twist  
 30,5x30,5 - 12"x12"



9STE Cream Prestige Twist  
 30,5x30,5 - 12"x12"



9STB Bardiglio Grey Twist  
 30,5x30,5 - 12"x12"



9STN Nero Marquina Twist  
 30,5x30,5 - 12"x12"

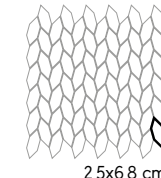

2,5x6,8 cm  
 1"x2 5/8"



9SCA Carrara Pure Chevron Wall  
 30,5x25 - 12"x9<sup>1</sup>/<sub>8</sub>"



9SCD Bianco Dolomite Chevron Wall  
 30,5x25 - 12"x9<sup>1</sup>/<sub>8</sub>"



9SCN Nero Marquina Chevron Wall  
 30,5x25 - 12"x9<sup>1</sup>/<sub>8</sub>"



9SCL Chevron Cold Wall  
 30,5x25 - 12"x9<sup>1</sup>/<sub>8</sub>"



9SCW Chevron Warm Wall  
 30,5x25 - 12"x9<sup>1</sup>/<sub>8</sub>"



9SCM Chevron Mix Wall  
 30,5x25 - 12"x9<sup>1</sup>/<sub>8</sub>"

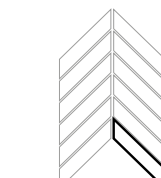

17,5x3,4 cm  
 6 7/8"x1 1/8"



ASEK Marvel Greca Gold •  
 7,8x30,5 - 3<sup>1</sup>/<sub>8</sub>"x12"

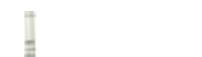

ASEM Marvel Greca A.E. •  
 7,8x1,2 - 3<sup>1</sup>/<sub>8</sub>"x1/2"



LVGB Marvel Gold Black •  
 7,8x30,5 - 3<sup>1</sup>/<sub>8</sub>"x12"



AVGB Marvel Gold Black A.E. •  
 7,8x1,2 - 3<sup>1</sup>/<sub>8</sub>"x1/2"



LVGW Marvel Gold White •  
 7,8x30,5 - 3<sup>1</sup>/<sub>8</sub>"x12"



AVGW Marvel Gold White A.E. •  
 7,8x1,2 - 3<sup>1</sup>/<sub>8</sub>"x1/2"

• Decor with gold insert. - Decoro con inserto in oro - Décor avec insert en or - Dekor mit Goldinlage - Decoración con aplicación de oro - Декор с золотой вставкой.

INDEX



PRODUCT FINDER



SURFACE RANGE



COMPANY



COLLECTIONS



3D WALL  
 CONCRETE & RESIN LOOK  
 METAL LOOK

MARBLE LOOK

STONE LOOK

WOOD LOOK

LARGE SIZES



TECHNICAL SPECIFICATIONS



# Aix

DOWNLOAD >  
CATALOG &  
IMAGE GALLERY

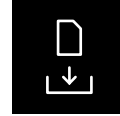

ENJOY THE  
VIDEO

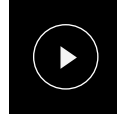

© Ceramiche Atlas Concorde



© Ceramiche Atlas Concorde



© Ceramiche Atlas Concorde

## Porcelain Tiles

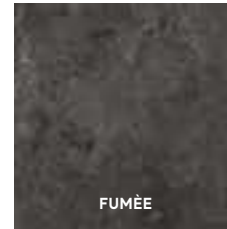

### COLOURED BODY PORCELAIN TILES - RECTIFIED MONOCALIBER

Sizes	Thickness	Surface finish
120x120 cm - 47 <sup>1</sup> / <sub>4</sub> "x47 <sup>1</sup> / <sub>4</sub> "	± 9 mm	Matte R10 A+B
75x150 cm - 29 <sup>1</sup> / <sub>2</sub> "x59"	± 9 mm	Matte R10 A+B
75x75 cm - 29 <sup>1</sup> / <sub>2</sub> "x29 <sup>1</sup> / <sub>2</sub> "	± 9 mm	Matte R10 A+B
37,5x75 cm - 14 <sup>3</sup> / <sub>4</sub> "x29 <sup>1</sup> / <sub>2</sub> "	± 9 mm	Matte R10 A+B

LARGE SIZES p. 390

### OUTDOOR PAVING AND WET AREAS

Sizes	Thickness	Surface finish
37,5x75 cm - 14 <sup>3</sup> / <sub>4</sub> "x29 <sup>1</sup> / <sub>2</sub> "	± 9 mm	Grip R11 A+B+C
22,5x45,3 cm - 8 <sup>7</sup> / <sub>8</sub> "x17 <sup>1</sup> / <sub>4</sub> " NON RECTIFIED	± 9 mm	Textured R11 A+B+C
22,5x22,5 cm - 8 <sup>7</sup> / <sub>8</sub> "x8 <sup>7</sup> / <sub>8</sub> " NON RECTIFIED	± 9 mm	Textured R11 A+B+C
120x120 cm - 47 <sup>1</sup> / <sub>4</sub> "x47 <sup>1</sup> / <sub>4</sub> "	± 20 mm	Outdoor R11 A+B+C
60x90 cm - 23 <sup>3</sup> / <sub>8</sub> "x35 <sup>3</sup> / <sub>8</sub> "	± 20 mm	Outdoor R11 A+B+C
60x60 cm - 23 <sup>3</sup> / <sub>8</sub> "x23 <sup>3</sup> / <sub>8</sub> "	± 20 mm	Outdoor R11 A+B+C
22,5x45,4 cm - 8 <sup>7</sup> / <sub>8</sub> "x17 <sup>1</sup> / <sub>4</sub> " NON RECTIFIED	± 20 mm	Outdoor R11 A+B+C
22,5x22,5 cm - 8 <sup>7</sup> / <sub>8</sub> "x8 <sup>7</sup> / <sub>8</sub> " NON RECTIFIED	± 20 mm	Outdoor R11 A+B+C

## Wall Tiles



### WHITEBODY WALL TILES - RECTIFIED MONOCALIBER

Sizes	Thickness	Surface finish
40x80 cm - 15 <sup>3</sup> / <sub>4</sub> "x31 <sup>1</sup> / <sub>2</sub> "	± 8,5 mm	Matte
<b>3D WALL TILES</b>		
40x80 cm - 15 <sup>3</sup> / <sub>4</sub> "x31 <sup>1</sup> / <sub>2</sub> "	± 10 mm	Matte

**Coloured body porcelain tiles** – Gres porcellanato colorato in massa – Grès cérame coloré dans la masse – Durchgefärbtes Feinsteinzeug – Gres porcelánico coloreado en masa – Керамический гранит окрашенный в массу  
**Whitebody wall tiles** – Rivestimenti in pasta bianca – Revêtements en pâte blanche – Weißscherbige Wandfliesen – Revestimientos en pasta blanca – Настенная плитка из белой глины  
**Rectified monocaliber** – Rettificato monocalibro – Rectifié mono-calibre – Geschliffen einkalbrig – Rectificado monocallibre – Ретифицированный в одном калибре  
**Non rectified** – Non rettificato – Non rectifié – Nicht rektifiziert – No rectificada – Неретифицированные

INDEX



PRODUCT  
FINDER



SURFACE  
RANGE



COMPANY



COLLECTIONS



- 3D WALL
- CONCRETE & RESIN LOOK
- METAL LOOK
- MARBLE LOOK
- STONE LOOK
- WOOD LOOK

LARGE SIZES



TECHNICAL  
SPECIFICATIONS



# Aix

## Porcelain Tiles

### MATTE SURFACE

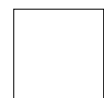

± 9 mm

**120x120 cm** - 47<sup>1</sup>/<sub>4</sub>"x47<sup>1</sup>/<sub>4</sub>"  
 AØ5N Aix Blanc  
 AØ5O Aix Beige  
 AØ5Q Aix Cendre  
 AØ5R Aix Fumée



± 9 mm

**75x150 cm** - 29<sup>1</sup>/<sub>2</sub>"x59"  
 A7GJ Aix Blanc  
 A7GK Aix Beige  
 A7GL Aix Cendre  
 A7GM Aix Fumée



± 9 mm

**75x75 cm** - 29<sup>1</sup>/<sub>2</sub>"x29<sup>1</sup>/<sub>2</sub>"  
 APSC Aix Blanc  
 APSI Aix Beige  
 APSE Aix Cendre  
 APSF Aix Fumée



± 9 mm

**37,5x75 cm** - 14<sup>3</sup>/<sub>4</sub>"x29<sup>1</sup>/<sub>2</sub>"  
 APSG Aix Blanc  
 APSD Aix Beige  
 APSJ Aix Cendre  
 APSK Aix Fumée

**H** HEAVY TRAFFIC  
 Matte ± 9 mm  
 Grip ± 9 mm  
 Textured ± 9 mm  
 Outdoor ± 20 mm

**R10 A+B** Matte ± 9 mm  
**R11 A+B+C** Grip ± 9 mm  
**R11 A+B+C** Textured ± 9 mm  
**R11 A+B+C** Outdoor ± 20 mm

**V3** Moderate Variation



### GRIP SURFACE



± 9 mm

**37,5x75 cm** - 14<sup>3</sup>/<sub>4</sub>"x29<sup>1</sup>/<sub>2</sub>"  
 APPL Aix Blanc Grip  
 APSM Aix Beige Grip  
 APSO Aix Cendre Grip  
 APSQ Aix Fumée Grip

### TEXTURED SURFACE



± 9 mm

**22,5x45,3 cm** - 8<sup>7</sup>/<sub>8</sub>"x17<sup>3</sup>/<sub>4</sub>"  
 NON RECTIFIED  
 APST Aix Beige Strutturato  
 APSU Aix Cendre Strutturato



± 9 mm

**22,5x22,5 cm** - 8<sup>7</sup>/<sub>8</sub>"x8<sup>7</sup>/<sub>8</sub>"  
 NON RECTIFIED  
 APSR Aix Beige Strutturato  
 APSS Aix Cendre Strutturato

### OUTDOOR ± 20 mm

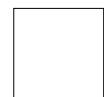

± 20 mm

**120x120 cm** - 47<sup>1</sup>/<sub>4</sub>"x47<sup>1</sup>/<sub>4</sub>"  
 AØ7C Aix Blanc 20 mm  
 AØ7E Aix Beige 20 mm  
 AØ7F Aix Cendre 20 mm  
 AØ7G Aix Fumée 20 mm



± 20 mm

**60x90 cm** - 23<sup>5</sup>/<sub>8</sub>"x35<sup>3</sup>/<sub>8</sub>"  
 APS1 Aix Blanc 20 mm  
 APS2 Aix Beige 20 mm  
 APS4 Aix Cendre 20 mm  
 APS5 Aix Fumée 20 mm



± 20 mm

**60x60 cm** - 23<sup>5</sup>/<sub>8</sub>"x23<sup>5</sup>/<sub>8</sub>"  
 APSZ Aix Beige 20 mm  
 APSØ Aix Cendre 20 mm



± 20 mm

**22,5x45,4 cm** - 8<sup>7</sup>/<sub>8</sub>"x17<sup>3</sup>/<sub>4</sub>"  
 NON RECTIFIED  
 APR2 Aix Beige 20 mm  
 APR3 Aix Cendre 20 mm



± 20 mm

**22,5x22,5 cm** - 8<sup>7</sup>/<sub>8</sub>"x8<sup>7</sup>/<sub>8</sub>"  
 NON RECTIFIED  
 APR4 Aix Beige 20 mm  
 APR5 Aix Cendre 20 mm

**Matte surface** - Superficie matt - Surface Mat - Matte Oberfläche - Superficie Mate - Матовая поверхность  
**Grip surface** - Superficie grip - Surface grip - Grip Oberfläche - Superficie Grip - Grip поверхность  
**Textured surface** - Superficie strutturata - Surface structuré - Strukturierte Oberfläche - Superficie estructurado - Структурная поверхность  
**Outdoor** - Pavimenti da esterno - Sols d'extérieur - Bodenbeläge für Außenbereiche - Pavimentos para exteriores - Уличная плитка

MATTE / GRIP



BLANC



BEIGE

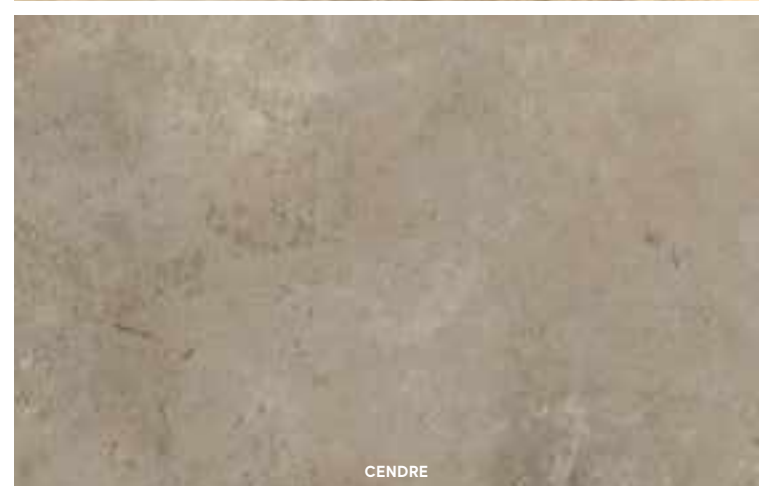

CENDRE



FUMÉE

OUTDOOR 20 mm



BLANC



BEIGE



CENDRE



FUMÉE

INDEX



PRODUCT  
FINDER



SURFACE  
RANGE



COMPANY



COLLECTIONS



- 3D WALL
- CONCRETE & RESIN LOOK
- METAL LOOK
- MARBLE LOOK
- STONE LOOK
- WOOD LOOK

LARGE SIZES



TECHNICAL  
SPECIFICATIONS



# Aix

## Porcelain Tiles

### DECOR RANGE



**AØ4X Aix Blanc Kit Multifornato Tumbled ▲**  
 1 pcs 75x75 - 29 1/2"x29 1/2"  
 1 pcs 50x75 - 19 5/8"x29 1/2"  
 1 pcs 50x50 - 19 5/8"x19 5/8"  
 3 pcs 25x50 - 9 7/8"x19 5/8"  
 2 pcs 25x25 - 9 7/8"x9 7/8"



**AØ4Y Aix Beige Kit Multifornato Tumbled ▲**  
 1 pcs 75x75 - 29 1/2"x29 1/2"  
 1 pcs 50x75 - 19 5/8"x29 1/2"  
 1 pcs 50x50 - 19 5/8"x19 5/8"  
 3 pcs 25x50 - 9 7/8"x19 5/8"  
 2 pcs 25x25 - 9 7/8"x9 7/8"



**AØ4Z Aix Cendre Kit Multifornato Tumbled ▲**  
 1 pcs 75x75 - 29 1/2"x29 1/2"  
 1 pcs 50x75 - 19 5/8"x29 1/2"  
 1 pcs 50x50 - 19 5/8"x19 5/8"  
 3 pcs 25x50 - 9 7/8"x19 5/8"  
 2 pcs 25x25 - 9 7/8"x9 7/8"



**AØ5C Aix Fumée Kit Multifornato Tumbled ▲**  
 1 pcs 75x75 - 29 1/2"x29 1/2"  
 1 pcs 50x75 - 19 5/8"x29 1/2"  
 1 pcs 50x50 - 19 5/8"x19 5/8"  
 3 pcs 25x50 - 9 7/8"x19 5/8"  
 2 pcs 25x25 - 9 7/8"x9 7/8"

▲ Tumbled - Burattato - Tamisé - Genarbt - Tamboreado - Выщербленный

The miniatures of the Kit Multifornato are not in proportion. - Les illustrations à échelle réduite dans le Kit Multifornato ne sont pas proportionnelles. - Die Abbildungen im Kit Multifornato sind nicht verhältnismäßig. - Los miniaturas en el Kit Multifornato no están en proporción. - Изображения Kit Multifornato не соблюдают пропорций.



**AØUA Aix Blanc Honeycomb Tumbled** 30x31- 11 1/4"x12 1/4"  
**AØUB Aix Beige Honeycomb Tumbled** 30x31- 11 1/4"x12 1/4"  
**AØUC Aix Cendre Honeycomb Tumbled** 30x31- 11 1/4"x12 1/4"  
**AØUD Aix Fumée Honeycomb Tumbled** 30x31- 11 1/4"x12 1/4"



**AØTZ Aix Blanc Mosaico Tumbled ▲** 30x30 - 11 1/4"x11 1/4"  
**AØTØ Aix Beige Mosaico Tumbled ▲** 30x30 - 11 1/4"x11 1/4"  
**AØT8 Aix Cendre Mosaico Tumbled ▲** 30x30 - 11 1/4"x11 1/4"  
**AØT9 Aix Fumée Mosaico Tumbled ▲** 30x30 - 11 1/4"x11 1/4"



**AØUE Aix Blanc Brick Tumbled ▲** 37x37 - 14 5/8"x14 5/8"  
**AØUF Aix Beige Brick Tumbled ▲** 37x37 - 14 5/8"x14 5/8"



**AØUG Aix Cendre Brick Tumbled ▲** 37x37 - 14 5/8"x14 5/8"  
**AØUH Aix Fumée Brick Tumbled ▲** 37x37 - 14 5/8"x14 5/8"

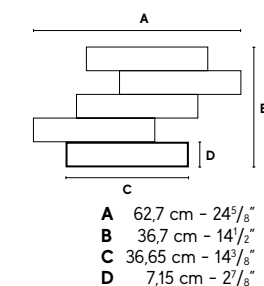
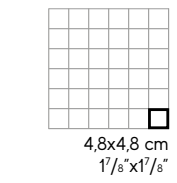
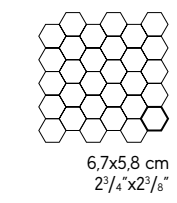

TRIM TILES	Battiscopa	Gradino *	Scalino *	Scalin Ang.*	Battiscopa Sag. Scala *	Elemento L Grip *	Elemento L Strutt. *
p. 462							
7,2x75 cm 2 7/8"x29 1/2"	37,5x75 cm 14 1/4"x29 1/2"	37,5x150 cm 14 1/4"x59"	33x120 cm 13"x47 1/4"	37,5x75 cm 14 1/4"x29 1/2"	7,2x30 cm 2 7/8"x11 7/8"	15x75 H. 4 cm 5 7/8"x29 1/2" H. 1 1/8"	15x30 H. 3,5 cm 5 7/8"x11 1/4" H. 1 1/8"
Matt	Matt	Matt	Matt	Matt	Matt	Matt	Matt
	AØSF	AØSR	AØSV AØST AØSZ	AØTJ AØSY	DX SX	AØTR	-
	AØSG	AØSS	AØSW AØSU AØSØ	AØTK AØSX	AØSJ AØSN	AØTS	AØTW
	AØSH	AØST	AØSX AØSV AØS8	AØTP AØSZ	AØSK AØSO	AØTT	AØTX
	AØSI	AØSU	AØSY AØSW AØS9	AØTQ AØJ	AØSL AØSP	AØTU	-
					AØSM AØSQ		

\* These parts are supplied to order - I pezzi sono disponibili su ordinazione - Les pièces sont disponibles sur commande - Die Teile sind auf Bestellung lieferbar - Las piezas se hacen por encargo - Изготавливаются на заказ

INDEX



PRODUCT FINDER



SURFACE RANGE



COMPANY



COLLECTIONS



- 3D WALL
- CONCRETE & RESIN LOOK
- METAL LOOK
- MARBLE LOOK

STONE LOOK

WOOD LOOK

LARGE SIZES



TECHNICAL SPECIFICATIONS



# Aix Wall Tiles

## MATTE SURFACE



± 8.5 mm  
40x80 cm - 15<sup>7</sup>/<sub>8</sub>"x31<sup>1</sup>/<sub>2</sub>"  
8AIB Aix Blanc  
8AIE Aix Beige  
8AIC Aix Cendre

± 10 mm 3D WALL  
40x80 cm - 15<sup>7</sup>/<sub>8</sub>"x31<sup>1</sup>/<sub>2</sub>"  
8A3B Aix 3D Row Blanc  
8A3E Aix 3D Row Beige  
8A3C Aix 3D Row Cendre

## TRIM TILES



1,4x40 cm - 5<sup>5</sup>/<sub>8</sub>"x15<sup>7</sup>/<sub>8</sub>"  
LA1I Aix Blanc Corner 40 \*  
LA1C Aix Cendre Corner 40 \*  
LA1E Aix Beige Corner 40 \*  
LA3B Aix 3D Blanc Corner 40 \*  
LA3C Aix 3D Cendre Corner 40 \*  
LA3E Aix 3D Beige Corner 40 \*

1,4x1,4 cm - 5<sup>5</sup>/<sub>8</sub>"x5<sup>5</sup>/<sub>8</sub>"  
AØ1B Aix Blanc Corner A.E. 1,4 \*  
AØ1C Aix Cendre Corner A.E. 1,4 \*  
AØ1E Aix Beige Corner A.E. 1,4 \*

\* These parts are supplied to order - I pezzi sono disponibili su ordinazione - Les pièces sont disponibles sur commande - Die Teile sind auf Bestellung lieferbar - Las piezas se hacen por encargo - Изготавливаются на заказ  
Matte surface - Superficie matt - Surface Mat - Matte Oberfläche - Superficie Mate - Матовая поверхность



## DECOR RANGE



9AKB Aix Blanc  
Minibrick Tumbled ▲  
30,5x30,5 - 12"x12"



9AKE Aix Beige  
Minibrick Tumbled ▲  
30,5x30,5 - 12"x12"



9AKC Aix Cendre  
Minibrick Tumbled ▲  
30,5x30,5 - 12"x12"

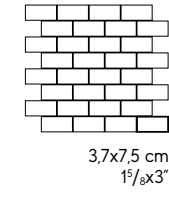

▲ Tumbled - Burattato - Tamisé - Genarbt - Tamboreado - Выщербленный



INDEX



PRODUCT  
FINDER



SURFACE  
RANGE



COMPANY



COLLECTIONS



- 3D WALL
- CONCRETE & RESIN LOOK
- METAL LOOK
- MARBLE LOOK
- STONE LOOK
- WOOD LOOK

LARGE SIZES



TECHNICAL  
SPECIFICATIONS



# Boost Mix

DOWNLOAD >  
CATALOG &  
IMAGE GALLERY

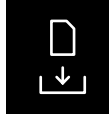

© Ceramiche Atlas Concorde



© Ceramiche Atlas Concorde



© Ceramiche Atlas Concorde

## Porcelain Tiles



### COLOURED BODY PORCELAIN TILES - RECTIFIED MONOCALIBER

Sizes	Thickness	Surface finish
120x278 cm - 47 <sup>1</sup> / <sub>4</sub> "x109 <sup>1</sup> / <sub>2</sub> "	± 6 mm	Matte R9 A
120x120 cm - 47 <sup>1</sup> / <sub>4</sub> "x47 <sup>1</sup> / <sub>4</sub> "	± 9 mm	Matte R10 A+B
60x120 cm - 23 <sup>5</sup> / <sub>8</sub> "x47 <sup>1</sup> / <sub>4</sub> "	± 9 mm	Matte R10 A+B
60x60 cm - 23 <sup>5</sup> / <sub>8</sub> "x23 <sup>5</sup> / <sub>8</sub> "	± 9 mm	Matte R10 A+B
30x60 cm - 11 <sup>3</sup> / <sub>4</sub> "x23 <sup>5</sup> / <sub>8</sub> "	± 9 mm	Matte R10 A+B

LARGE SIZES p. 390

### OUTDOOR PAVING AND WET AREAS

Sizes	Thickness	Surface finish
30x60 cm - 11 <sup>3</sup> / <sub>4</sub> "x23 <sup>5</sup> / <sub>8</sub> "	± 9 mm	Grip R11 A+B+C
120x120 cm - 47 <sup>1</sup> / <sub>4</sub> "x47 <sup>1</sup> / <sub>4</sub> "	± 20 mm	Outdoor R11 A+B+C
60x120 cm - 23 <sup>5</sup> / <sub>8</sub> "x47 <sup>1</sup> / <sub>4</sub> "	± 20 mm	Outdoor R11 A+B+C
60x60 cm - 23 <sup>5</sup> / <sub>8</sub> "x23 <sup>5</sup> / <sub>8</sub> "	± 20 mm	Outdoor R11 A+B+C

INDEX



PRODUCT  
FINDER



SURFACE  
RANGE



COMPANY



COLLECTIONS



- 3D WALL
- CONCRETE & RESIN LOOK
- METAL LOOK
- MARBLE LOOK
- STONE LOOK
- WOOD LOOK

LARGE SIZES



TECHNICAL  
SPECIFICATIONS



Coloured body porcelain tiles - Gres porcellanato colorato in massa - Grès cérame coloré dans la masse - Durchgefärbtes Feinsteinzeug - Gres porcelánico coloreado en masa - Керамический гранит окрашенный в массе  
Rectified monocaliber - Rettificato monocalibro - Rectifié mono-calibre - Geschliffen einkalbrig - Rectificado monocalibre - Ретифицированный в одном калибре



# Boost Mix

## Porcelain Tiles



### MATTE SURFACE

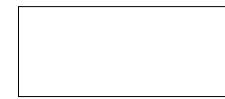

± 6 mm  
**120x278 cm** - 47<sup>1</sup>/<sub>4</sub>"x109<sup>1</sup>/<sub>2</sub>"  
 A8Y7 Boost Mix Ivory  
 A8Y8 Boost Mix Pearl  
 A8Y9 Boost Mix Smoke



± 9 mm  
**120x120 cm** - 47<sup>1</sup>/<sub>4</sub>"x47<sup>1</sup>/<sub>4</sub>"  
 A8XD Boost Mix Ivory  
 A8XE Boost Mix Pearl  
 A8XF Boost Mix Smoke



± 9 mm  
**60x120 cm** - 23<sup>5</sup>/<sub>8</sub>"x47<sup>1</sup>/<sub>4</sub>"  
 A8ØI Boost Mix Ivory  
 A8ØJ Boost Mix Pearl  
 A8ØK Boost Mix Smoke



± 9 mm  
**60x60 cm** - 23<sup>5</sup>/<sub>8</sub>"x23<sup>5</sup>/<sub>8</sub>"  
 A8ØL Boost Mix Ivory  
 A8ØM Boost Mix Pearl  
 A8ØN Boost Mix Smoke



± 9 mm  
**30x60 cm** - 11<sup>3</sup>/<sub>4</sub>"x23<sup>5</sup>/<sub>8</sub>"  
 A8ØO Boost Mix Ivory  
 A8ØP Boost Mix Pearl  
 A8ØQ Boost Mix Smoke



### GRIP SURFACE



± 9 mm  
**30x60 cm** - 11<sup>3</sup>/<sub>4</sub>"x23<sup>5</sup>/<sub>8</sub>"  
 A8ØR Boost Mix Ivory Grip  
 A8ØS Boost Mix Pearl Grip  
 A8ØT Boost Mix Smoke Grip

### OUTDOOR ± 20 mm



± 20 mm  
**120x120 cm** - 47<sup>1</sup>/<sub>4</sub>"x47<sup>1</sup>/<sub>4</sub>"  
 A84U Boost mix Ivory 20 mm  
 A84V Boost mix Pearl 20 mm  
 A84W Boost mix Smoke 20 mm



± 20 mm  
**60x120 cm** - 23<sup>5</sup>/<sub>8</sub>"x47<sup>1</sup>/<sub>4</sub>"  
 A84R Boost Mix Ivory 20 mm  
 A84S Boost Mix Pearl 20 mm  
 A84T Boost Mix Smoke 20 mm



± 20 mm  
**60x60 cm** - 23<sup>5</sup>/<sub>8</sub>"x23<sup>5</sup>/<sub>8</sub>"  
 A84O Boost Mix Ivory 20 mm  
 A84P Boost Mix Pearl 20 mm  
 A84Q Boost Mix Smoke 20 mm



IVORY

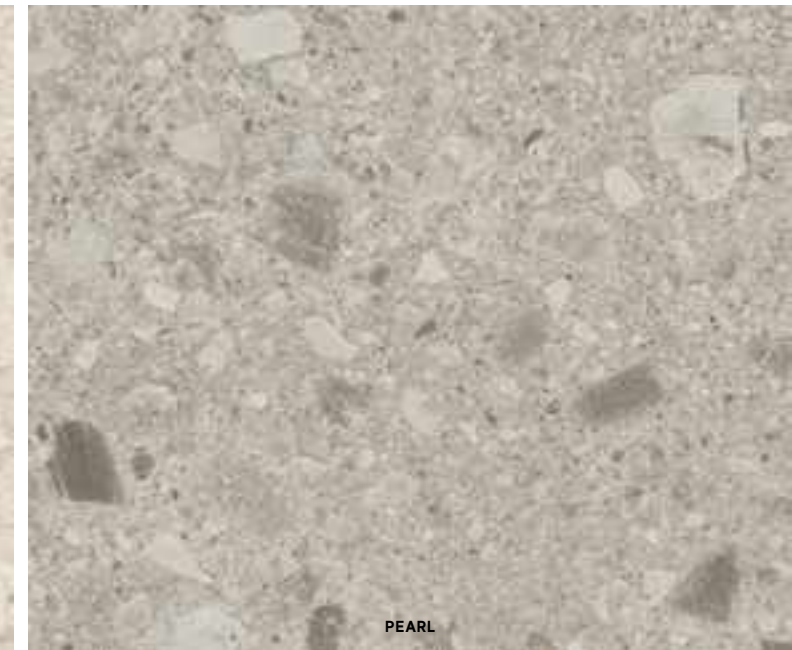

PEARL



SMOKE

### TRIM TILES

p. 462

	Battiscopa		Gradino *		Scalino *		Scalin Ang.*	Corner *	Corner A.E *	Battiscopa Sag. Scala *		Elemento L
	7,2x120 cm 2 <sup>7</sup> / <sub>8</sub> "x47 <sup>1</sup> / <sub>4</sub> "	7,2x60 cm 2 <sup>7</sup> / <sub>8</sub> "x23 <sup>5</sup> / <sub>8</sub> "	30x120 cm 11 <sup>3</sup> / <sub>4</sub> "x47 <sup>1</sup> / <sub>4</sub> "	30x60 cm 11 <sup>3</sup> / <sub>4</sub> "x23 <sup>5</sup> / <sub>8</sub> "	33x120 cm 13"x47 <sup>1</sup> / <sub>4</sub> "	33x60 cm 13"x23 <sup>5</sup> / <sub>8</sub> "	33x33 cm 13"x13"	1x120 cm 3 <sup>7</sup> / <sub>8</sub> "x47 <sup>1</sup> / <sub>4</sub> "	1x1 cm 3 <sup>7</sup> / <sub>8</sub> "x1 <sup>1</sup> / <sub>4</sub> "	7,2x30 cm 2 <sup>7</sup> / <sub>8</sub> "x11 <sup>3</sup> / <sub>4</sub> "	15x60 H. 4 cm 5 <sup>7</sup> / <sub>8</sub> "x23 <sup>5</sup> / <sub>8</sub> " H. 1 <sup>1</sup> / <sub>8</sub> "	
	Matt	Matt	Matt	Matt	Matt	Matt	Matt	Matt	Matt	DX Matt	SX	Grip
Ivory	A83O	A83L	A832	A83X	A838	A835	A84C	A84I	A84L	A83U	A83R	A84F
Pearl	A83P	A83M	A833	A83Y	A839	A836	A84D	A84J	A84M	A83V	A83S	A84G
Smoke	A83Q	A83N	A834	A83Z	A84B	A837	A84E	A84K	A84N	A83W	A83T	A84H

\* These parts are supplied to order - I pezzi sono disponibili su ordinazione - Les pièces sont disponibles sur commande - Die Teile sind auf Bestellung lieferbar - Las piezas se hacen por encargo - Изготавливаются на заказ

Matte surface - Superficie matt - Surface Mat - Matte Oberfläche - Superficie Mate - Матовая поверхность  
 Grip surface - Superficie grip - Surface grip - Grip Oberfläche - Superficie Grip - Grip поверхность  
 Outdoor - Pavimenti da esterno - Sols d'extérieur - Bodenbeläge für Außenbereiche - Pavimentos para exteriores - Уличная плитка

INDEX



PRODUCT  
FINDER



SURFACE  
RANGE



COMPANY



COLLECTIONS



- 3D WALL
- CONCRETE & RESIN LOOK
- METAL LOOK
- MARBLE LOOK

STONE LOOK

WOOD LOOK

LARGE SIZES



TECHNICAL  
SPECIFICATIONS



# Boost Mix

## Porcelain Tiles

### DECOR RANGE



A829 Boost Mix Ivory  
Mosaico Matt  
30x30 - 11<sup>3</sup>/<sub>8</sub>"x11<sup>3</sup>/<sub>8</sub>"



A83G Boost Mix Pearl  
Mosaico Matt  
30x30 - 11<sup>3</sup>/<sub>8</sub>"x11<sup>3</sup>/<sub>8</sub>"



A83H Boost Mix Smoke  
Mosaico Matt  
30x30 - 11<sup>3</sup>/<sub>8</sub>"x11<sup>3</sup>/<sub>8</sub>"

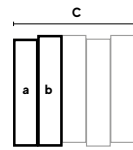
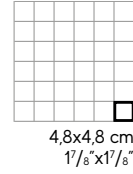

**a** 6,3x28,8 cm - 2<sup>1</sup>/<sub>2</sub>"x11<sup>3</sup>/<sub>8</sub>"  
**b** 6,3x29,8 cm - 5<sup>5</sup>/<sub>8</sub>"x11<sup>3</sup>/<sub>8</sub>"  
**c** 32,57 cm - 12<sup>7</sup>/<sub>8</sub>"



A83I Boost Mix Ivory  
Mosaico Slide  
29x32,6 - 11<sup>3</sup>/<sub>8</sub>"x12<sup>1</sup>/<sub>8</sub>"



A83J Boost Mix Pearl  
Mosaico Slide  
29x32,6 - 11<sup>3</sup>/<sub>8</sub>"x12<sup>1</sup>/<sub>8</sub>"



A83K Boost Mix Smoke  
Mosaico Slide  
29x32,6 - 11<sup>3</sup>/<sub>8</sub>"x12<sup>1</sup>/<sub>8</sub>"



INDEX

PRODUCT FINDER

SURFACE RANGE

COMPANY

COLLECTIONS

- 3D WALL
- CONCRETE & RESIN LOOK
- METAL LOOK
- MARBLE LOOK
- STONE LOOK
- WOOD LOOK

LARGE SIZES

TECHNICAL SPECIFICATIONS

# Boost Stone

DOWNLOAD >  
CATALOG &  
IMAGE GALLERY

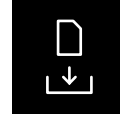

ENJOY THE  
VIDEO

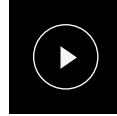

© Ceramiche Atlas Concorde



© Ceramiche Atlas Concorde



© Ceramiche Atlas Concorde

## Porcelain Tiles

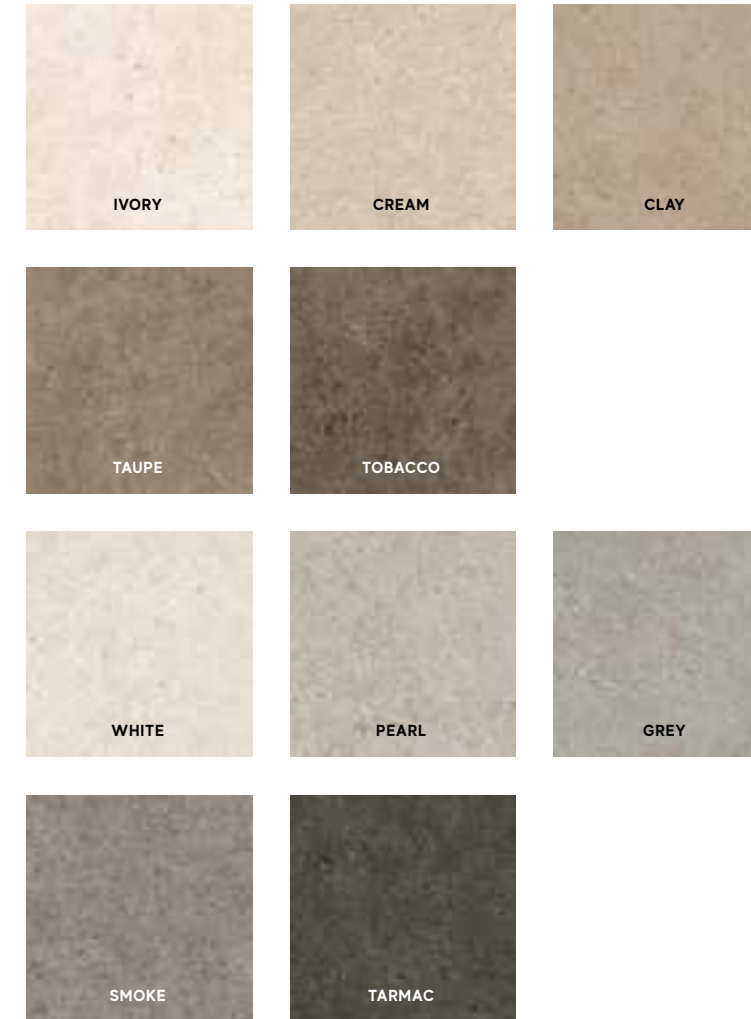

### COLOURED BODY PORCELAIN TILES - RECTIFIED MONOCALIBER

Sizes	Thickness	Surface finish
162x324 cm - 63 <sup>3</sup> / <sub>4</sub> "x127 <sup>1</sup> / <sub>2</sub> " NON RECTIFIED	± 12 mm	Hammered
120x278 cm - 47 <sup>1</sup> / <sub>4</sub> "x109 <sup>1</sup> / <sub>2</sub> "	± 6 mm	Matte R9 A
120x120 cm - 47 <sup>1</sup> / <sub>4</sub> "x47 <sup>1</sup> / <sub>4</sub> "	± 9 mm	Matte R10 A+B
60x120 cm - 23 <sup>5</sup> / <sub>8</sub> "x47 <sup>1</sup> / <sub>4</sub> "	± 9 mm	Matte R10 A+B
60x60 cm - 23 <sup>5</sup> / <sub>8</sub> "x23 <sup>5</sup> / <sub>8</sub> "	± 9 mm	Matte R10 A+B
30x60 cm - 11 <sup>3</sup> / <sub>4</sub> "x23 <sup>5</sup> / <sub>8</sub> "	± 9 mm	Matte R10 A+B

LARGE SIZES p. 390

### OUTDOOR PAVING AND WET AREAS

Sizes	Thickness	Surface finish
60x120 cm - 23 <sup>5</sup> / <sub>8</sub> "x47 <sup>1</sup> / <sub>4</sub> "	± 9 mm	Grip R11 A+B+C
30x60 cm - 11 <sup>3</sup> / <sub>4</sub> "x23 <sup>5</sup> / <sub>8</sub> "	± 9 mm	Grip R11 A+B+C
120x120 cm - 47 <sup>1</sup> / <sub>4</sub> "x47 <sup>1</sup> / <sub>4</sub> "	± 20 mm	Outdoor R11 A+B+C
60x120 cm - 23 <sup>5</sup> / <sub>8</sub> "x47 <sup>1</sup> / <sub>4</sub> "	± 20 mm	Outdoor R11 A+B+C
60x60 cm - 23 <sup>5</sup> / <sub>8</sub> "x23 <sup>5</sup> / <sub>8</sub> "	± 20 mm	Outdoor R11 A+B+C

Coloured body porcelain tiles - Gres porcellanato colorato in massa - Grès cérame coloré dans la masse - Durchgefärbtes Feinsteinzeug - Gres porcelánico coloreado en masa - Керамический гранит окрашенный в массу  
 Whitebody wall tiles - Rivestimenti in pasta bianca - Revêtements en pâte blanche - Weißscherbige Wandfliesen - Revestimientos en pasta blanca - Настенная плитка из белой глины  
 Non rectified - Non rettificato - Non rectifié - Nicht rektifiziert - No rectificada - Неретифицированные

INDEX



PRODUCT  
FINDER



SURFACE  
RANGE



COMPANY



COLLECTIONS



- 3D WALL
- CONCRETE & RESIN LOOK
- METAL LOOK
- MARBLE LOOK
- STONE LOOK
- WOOD LOOK

LARGE SIZES



TECHNICAL  
SPECIFICATIONS



# Boost Stone

## Porcelain Tiles



Matte ± 6 mm



Matte ± 9 mm  
Grip ± 9 mm  
Outdoor ± 20 mm



R9 A Matte ± 6 mm  
R10 A+B Matte ± 9 mm  
R11 A+B+C Grip ± 9 mm  
R11 A+B+C Outdoor ± 20 mm



V2 Slight Variation

### MATTE SURFACE

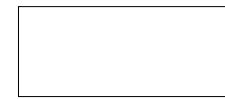

± 6 mm

120x278 cm - 47 1/4" x 109 1/2"

- A6R7 B.Stone White
- A6SD B.Stone Pearl
- A6SC B.Stone Grey
- A6SE B.Stone Smoke
- A6SG B.Stone Tarmac
- A6R8 B.Stone Ivory
- A6R9 B.Stone Cream
- A6SA B.Stone Clay
- A6SB B.Stone Taupe
- A6SF B.Stone Tobacco



± 9 mm

120x120 cm - 47 1/4" x 47 1/4"

- A6QS B.Stone White
- A6QX B.Stone Pearl
- A6QY B.Stone Grey
- A6L8 B.Stone Smoke
- A6QØ B.Stone Tarmac
- A6QT B.Stone Ivory
- A6QU B.Stone Cream
- A6QV B.Stone Clay
- A6QW B.Stone Taupe
- A6QZ B.Stone Tobacco



± 9 mm

60x120 cm - 23 5/8" x 47 1/4"

- A6Q2 B.Stone White
- A6Q7 B.Stone Pearl
- A6Q8 B.Stone Grey
- A6Q9 B.Stone Smoke
- A6RB B.Stone Tarmac
- A6Q3 B.Stone Ivory
- A6Q4 B.Stone Cream
- A6Q5 B.Stone Clay
- A6Q6 B.Stone Taupe
- A6RA B.Stone Tobacco



± 9 mm

60x60 cm - 23 5/8" x 23 5/8"

- A6RC B.Stone White
- A6RL B.Stone Pearl
- A6RM B.Stone Grey
- A6RN B.Stone Smoke
- A6RP B.Stone Tarmac
- A6RD B.Stone Ivory
- A6RI B.Stone Cream
- A6RJ B.Stone Clay
- A6RK B.Stone Taupe
- A6RO B.Stone Tobacco



± 9 mm

30x60 cm - 11 3/4" x 23 5/8"

- A6RX B.Stone White
- A6R2 B.Stone Pearl
- A6R3 B.Stone Grey
- A6R4 B.Stone Smoke
- A6R6 B.Stone Tarmac
- A6RY B.Stone Ivory
- A6RZ B.Stone Cream
- A6RØ B.Stone Clay
- A6R1 B.Stone Taupe
- A6R5 B.Stone Tobacco



atlasPLAN

p. 390



HAMMERED

162x324 cm - 63 1/4" x 127 1/4"  
NON RECTIFIED

### GRIP SURFACE

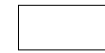

± 9 mm

60x120 cm - 23 5/8" x 47 1/4"

- A66R B.Stone White Grip
- A66W B.Stone Pearl Grip
- A66X B.Stone Grey Grip
- A66Y B.Stone Smoke Grip
- A66Ø B.Stone Tarmac Grip
- A66S B.Stone Ivory Grip
- A66T B.Stone Cream Grip
- A66U B.Stone Clay Grip
- A66V B.Stone Taupe Grip
- A66Z B.Stone Tobacco Grip



± 9 mm

30x60 cm - 11 3/4" x 23 5/8"

- A661 B.Stone White Grip
- A666 B.Stone Pearl Grip
- A667 B.Stone Grey Grip
- A668 B.Stone Smoke Grip
- A67A B.Stone Tarmac Grip
- A662 B.Stone Ivory Grip
- A663 B.Stone Cream Grip
- A664 B.Stone Clay Grip
- A665 B.Stone Taupe Grip
- A669 B.Stone Tobacco Grip

### OUTDOOR ± 20 mm



± 20 mm

120x120 cm - 47 1/4" x 47 1/4"

- A67M B.Stone White 20 mm
- A67P B.Stone Grey 20 mm
- A711 B.Stone Smoke 20 mm
- A67Q B.Stone Tarmac 20 mm
- A67N B.Stone Cream 20 mm
- A67O B.Stone Clay 20 mm



± 20 mm

60x120 cm - 23 5/8" x 47 1/4"

- A67R B.Stone White 20 mm
- A67U B.Stone Grey 20 mm
- A71J B.Stone Smoke 20 mm
- A67V B.Stone Tarmac 20 mm
- A67S B.Stone Cream 20 mm
- A67T B.Stone Clay 20 mm



± 20 mm

60x60 cm - 23 5/8" x 23 5/8"

- A67W B.Stone White 20 mm
- A67Z B.Stone Grey 20 mm
- A71K B.Stone Smoke 20 mm
- A67Ø B.Stone Tarmac 20 mm
- A67X B.Stone Cream 20 mm
- A67Y B.Stone Clay 20 mm



### TRIM TILES

p. 462

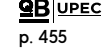

p. 455

- White
- Pearl
- Grey
- Smoke
- Tarmac
- Ivory
- Cream
- Clay
- Taupe
- Tobacco

### Battiscopa



7,2x60 cm  
2 7/8" x 23 5/8"

Matt

- A7NC
- A7NH
- A7NI
- A7NJ
- A7NL
- A7ND
- A7NE
- A7NF
- A7NG
- A7NK

### Gradino \*



30x60 cm  
11 3/4" x 23 5/8"

Matt

- A7N6
- A7OB
- A7OC
- A7OD
- A7OF
- A7N7
- A7N8
- A7N9
- A7OA
- A7OE

### Scalino \*



33x120 cm  
13" x 47 1/4"

Matt

- A7OQ
- A7OV
- A7OW
- A7OX
- A7OZ
- A7OR
- A7OS
- A7OT
- A7OU
- A7OY

### Scalin Ang.\*



33x33 cm  
13" x 13"

Matt

- A7OØ
- A7O5
- A7O6
- A7O7
- A7O9
- A7O1
- A7O2
- A7O3
- A7O4
- A7O8

### Corner \*



1x120 cm  
3/8" x 47 1/4"

Matt

- A7PA
- A7PF
- A7PG
- A7PH
- A7PJ
- A7PB
- A7PC
- A7PD
- A7PE
- A7PI

### Corner A.E.\*



1x1 cm  
3/8" x 3/8"

Matt

- A7PK
- A7PP
- A7PQ
- A7PR
- A7PT
- A7PL
- A7PM
- A7PN
- A7PO
- A7PS

### Battiscopa Sag. Scala \*



7,2x30 cm  
2 7/8" x 11 1/4"

Matt

- DX
- SX
- A7NW
- A7N1
- A7N2
- A7N3
- A7N5
- A7NX
- A7NY
- A7N4

### Elemento L



33x120 H. 4 cm  
13" x 47 1/4" H. 1 1/8"

Grip

- A7P8
- A7QD
- A7QE
- A7QF
- A7QH
- A7P9
- A7QA
- A7QB
- A7QC
- A7QG

\* These parts are supplied to order - I pezzi sono disponibili su ordinazione - Les pièces sont disponibles sur commande - Die Teile sind auf Bestellung lieferbar - Las piezas se hacen por encargo - Изготавливаются на заказ

Matte surface - Superficie matt - Surface Mat - Matte Oberfläche - Superficie Mate - Матовая поверхность  
Grip surface - Superficie grip - Surface grip - Grip Oberfläche - Superficie Grip - Grip поверхность  
Outdoor - Pavimenti da esterno - Sols d'extérieur - Bodenbeläge für Außenbereiche - Pavimentos para exteriores - Уличная плитка



WHITE



IVORY



PEARL



CREAM



GREY



CLAY



SMOKE

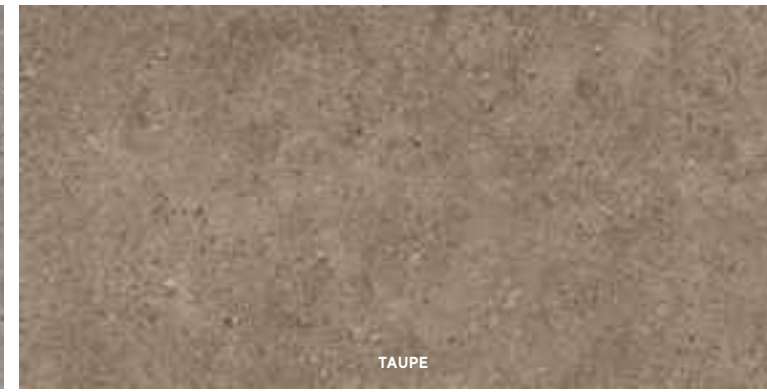

TAUPE

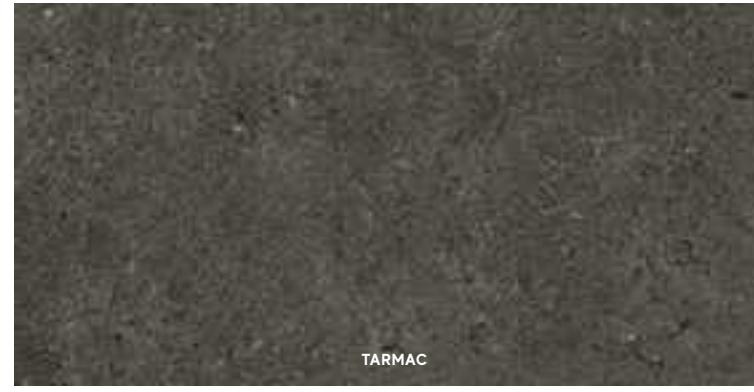

TARMAC

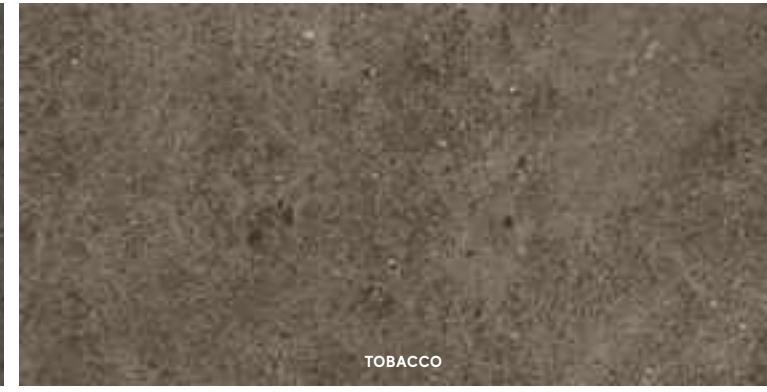

TOBACCO

INDEX



PRODUCT  
FINDER



SURFACE  
RANGE



COMPANY



COLLECTIONS



- 3D WALL
- CONCRETE & RESIN LOOK
- METAL LOOK
- MARBLE LOOK

STONE LOOK

WOOD LOOK

LARGE SIZES



TECHNICAL  
SPECIFICATIONS



# Boost Stone

## Porcelain Tiles

### DECOR RANGE



A7C3 Boost Stone White  
Mosaico Brick  
30x60 cm - 11<sup>1</sup>/<sub>4</sub>"x23<sup>5</sup>/<sub>8</sub>"

A7C4 Boost Stone Ivory  
Mosaico Brick  
30x60 cm - 11<sup>1</sup>/<sub>4</sub>"x23<sup>5</sup>/<sub>8</sub>"



A7C8 Boost Stone Pearl  
Mosaico Brick  
30x60 cm - 11<sup>1</sup>/<sub>4</sub>"x23<sup>5</sup>/<sub>8</sub>"

A7C5 Boost Stone Cream  
Mosaico Brick  
30x60 cm - 11<sup>1</sup>/<sub>4</sub>"x23<sup>5</sup>/<sub>8</sub>"



A7C9 Boost Stone Grey  
Mosaico Brick  
30x60 cm - 11<sup>1</sup>/<sub>4</sub>"x23<sup>5</sup>/<sub>8</sub>"

A7C6 Boost Stone Clay  
Mosaico Brick  
30x60 cm - 11<sup>1</sup>/<sub>4</sub>"x23<sup>5</sup>/<sub>8</sub>"



A7DA Boost Stone Smoke  
Mosaico Brick  
30x60 cm - 11<sup>1</sup>/<sub>4</sub>"x23<sup>5</sup>/<sub>8</sub>"

A7C7 Boost Stone Taupe  
Mosaico Brick  
30x60 cm - 11<sup>1</sup>/<sub>4</sub>"x23<sup>5</sup>/<sub>8</sub>"



A7DC Boost Stone Tarmac  
Mosaico Brick  
30x60 cm - 11<sup>1</sup>/<sub>4</sub>"x23<sup>5</sup>/<sub>8</sub>"

A7DB Boost Stone Tobacco  
Mosaico Brick  
30x60 cm - 11<sup>1</sup>/<sub>4</sub>"x23<sup>5</sup>/<sub>8</sub>"

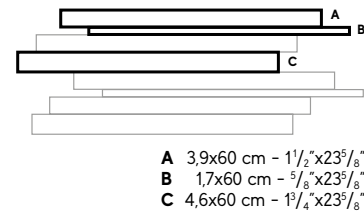

A7DD Boost Stone White  
Mosaico Matt  
30x30 cm - 11<sup>1</sup>/<sub>4</sub>"x11<sup>1</sup>/<sub>4</sub>"

A7DI Boost Stone Pearl  
Mosaico Matt  
30x30 cm - 11<sup>1</sup>/<sub>4</sub>"x11<sup>1</sup>/<sub>4</sub>"

A7DJ Boost Stone Grey  
Mosaico Matt  
30x30 cm - 11<sup>1</sup>/<sub>4</sub>"x11<sup>1</sup>/<sub>4</sub>"

A7DK Boost Stone Smoke  
Mosaico Matt  
30x30 cm - 11<sup>1</sup>/<sub>4</sub>"x11<sup>1</sup>/<sub>4</sub>"

A7DM Boost Stone Tarmac  
Mosaico Matt  
30x30 cm - 11<sup>1</sup>/<sub>4</sub>"x11<sup>1</sup>/<sub>4</sub>"



A7DE Boost Stone Ivory  
Mosaico Matt  
30x30 cm - 11<sup>1</sup>/<sub>4</sub>"x11<sup>1</sup>/<sub>4</sub>"

A7DF Boost Stone Cream  
Mosaico Matt  
30x30 cm - 11<sup>1</sup>/<sub>4</sub>"x11<sup>1</sup>/<sub>4</sub>"

A7DG Boost Stone Clay  
Mosaico Matt  
30x30 cm - 11<sup>1</sup>/<sub>4</sub>"x11<sup>1</sup>/<sub>4</sub>"

A7DH Boost Stone Taupe  
Mosaico Matt  
30x30 cm - 11<sup>1</sup>/<sub>4</sub>"x11<sup>1</sup>/<sub>4</sub>"

A7DL Boost Stone Tobacco  
Mosaico Matt  
30x30 cm - 11<sup>1</sup>/<sub>4</sub>"x11<sup>1</sup>/<sub>4</sub>"

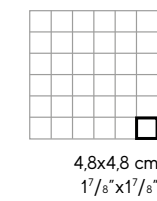

A67I Boost Stone White  
Mosaico Hex  
25x28,5 cm - 9<sup>7</sup>/<sub>8</sub>"x11<sup>1</sup>/<sub>4</sub>"

A7CY Boost Stone Pearl  
Mosaico Hex  
25x28,5 cm - 9<sup>7</sup>/<sub>8</sub>"x11<sup>1</sup>/<sub>4</sub>"

A7CZ Boost Stone Grey  
Mosaico Hex  
25x28,5 cm - 9<sup>7</sup>/<sub>8</sub>"x11<sup>1</sup>/<sub>4</sub>"

A7CØ Boost Stone Smoke  
Mosaico Hex  
25x28,5 cm - 9<sup>7</sup>/<sub>8</sub>"x11<sup>1</sup>/<sub>4</sub>"

A7C2 Boost Stone Tarmac  
Mosaico Hex  
25x28,5 cm - 9<sup>7</sup>/<sub>8</sub>"x11<sup>1</sup>/<sub>4</sub>"



A7CU Boost Stone Ivory  
Mosaico Hex  
25x28,5 cm - 9<sup>7</sup>/<sub>8</sub>"x11<sup>1</sup>/<sub>4</sub>"

A7CV Boost Stone Cream  
Mosaico Hex  
25x28,5 cm - 9<sup>7</sup>/<sub>8</sub>"x11<sup>1</sup>/<sub>4</sub>"

A7CW Boost Stone Clay  
Mosaico Hex  
25x28,5 cm - 9<sup>7</sup>/<sub>8</sub>"x11<sup>1</sup>/<sub>4</sub>"

A7CX Boost Stone Taupe  
Mosaico Hex  
25x28,5 cm - 9<sup>7</sup>/<sub>8</sub>"x11<sup>1</sup>/<sub>4</sub>"

A7C1 Boost Stone Tobacco  
Mosaico Hex  
25x28,5 cm - 9<sup>7</sup>/<sub>8</sub>"x11<sup>1</sup>/<sub>4</sub>"

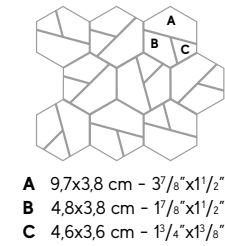

A7DO Boost Stone  
Mosaico Cube Warm  
30x30 cm - 11<sup>1</sup>/<sub>4</sub>"x11<sup>1</sup>/<sub>4</sub>"  
 Warm:  
 Boost Stone Cream  
 Boost Stone Clay  
 Boost Stone Ivory  
 Boost Pro Ivory

A7DN Boost Stone  
Mosaico Cube Cold  
30x30 cm - 11<sup>1</sup>/<sub>4</sub>"x11<sup>1</sup>/<sub>4</sub>"  
 Cold:  
 Boost Stone Smoke  
 Boost Stone Grey  
 Boost Stone Pearl  
 Boost Pearl

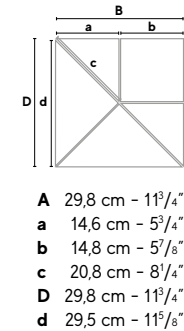

INDEX



PRODUCT  
FINDER



SURFACE  
RANGE



COMPANY



COLLECTIONS



- 3D WALL
- CONCRETE & RESIN LOOK
- METAL LOOK
- MARBLE LOOK
- STONE LOOK
- WOOD LOOK

LARGE SIZES



TECHNICAL  
SPECIFICATIONS



# Brave

DOWNLOAD >  
CATALOG &  
IMAGE GALLERY

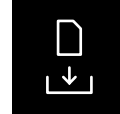

ENJOY THE  
VIDEO

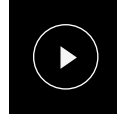

© Ceramiche Atlas Concorde



© Ceramiche Atlas Concorde



© Ceramiche Atlas Concorde

## Porcelain Tiles



### COLOURED BODY PORCELAIN TILES - RECTIFIED MONOCALIBER

Sizes	Thickness	Surface finish
75x150 cm - 29 1/2" x 59"	± 9 mm	Matte R10 A+B
75x75 cm - 29 1/2" x 29 1/2"	± 9 mm	Matte R10 A+B
45x90 cm - 17 3/4" x 35 3/8"	± 9 mm	Matte R10 A+B
60x60 cm - 23 5/8" x 23 5/8"	± 9 mm	Matte R10 A+B
30x60 cm - 11 3/4" x 23 5/8"	± 9 mm	Matte R10 A+B

### OUTDOOR PAVING AND WET AREAS

Sizes	Thickness	Surface finish
30x60 cm - 11 3/4" x 23 5/8"	± 9 mm	Grip R12 A+B+C
120x120 cm - 47 1/4" x 47 1/4"	± 20 mm	Outdoor R11 A+B+C
60x120 cm - 23 5/8" x 47 1/4"	± 20 mm	Outdoor R11 A+B+C
60x60 cm - 23 5/8" x 23 5/8"	± 20 mm	Outdoor R11 A+B+C
45x90 cm - 17 3/4" x 35 3/8"	± 20 mm	Outdoor R11 A+B+C

## Wall Tiles



### WHITEBODY WALL TILES - RECTIFIED MONOCALIBER

Sizes	Thickness	Surface finish
40x80 cm - 15 3/4" x 31 1/2"	± 8,5 mm	Matte
<b>3D WALL TILES</b>		
40x80 cm - 15 3/4" x 31 1/2"	± 10 mm	Matte

Coloured body porcelain tiles - Gres porcellanato colorato in massa - Grès cérame coloré dans la masse - Durchgefärbtes Feinsteinzeug - Gres porcelánico coloreado en masa - Керамический гранит окрашенный в массе  
 Whitebody wall tiles - Rivestimenti in pasta bianca - Revêtements en pâte blanche - Weißscherbige Wandfliesen - Revestimientos en pasta blanca - Настенная плитка из белой глины  
 Rectified monocaliber - Rettificato monocalibro - Rectifié mono-calibre - Geschliffen einkalibrig - Rectificado monocalibre - Ретифицированный в одном калибре

INDEX



PRODUCT  
FINDER



SURFACE  
RANGE



COMPANY



COLLECTIONS



- 3D WALL
- CONCRETE & RESIN LOOK
- METAL LOOK
- MARBLE LOOK
- STONE LOOK
- WOOD LOOK

LARGE SIZES



TECHNICAL  
SPECIFICATIONS



# Brave

## Porcelain Tiles

### MATTE SURFACE

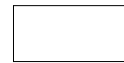

± 9 mm

**75x150 cm** - 29<sup>1</sup>/<sub>2</sub>"x59"  
A7G5 Brave Gypsum Matt  
A7G6 Brave Pearl Matt  
A7G7 Brave Grey Matt  
A7G8 Brave Earth Matt  
A7G9 Brave Coke Matt



± 9 mm

**75x75 cm** - 29<sup>1</sup>/<sub>2</sub>"x29<sup>1</sup>/<sub>2</sub>"  
AXAJ Brave Gypsum Matt  
AXAK Brave Pearl Matt  
AXAL Brave Grey Matt  
AXAM Brave Earth Matt  
AXAN Brave Coke Matt



± 9 mm

**60x60 cm** - 23<sup>5</sup>/<sub>8</sub>"x23<sup>5</sup>/<sub>8</sub>"  
AW9U Brave Gypsum Matt  
AW9V Brave Pearl Matt  
AW9W Brave Grey Matt  
AW9X Brave Earth Matt  
AW9Y Brave Coke Matt



± 9 mm

**30x60 cm** - 11<sup>3</sup>/<sub>4</sub>"x23<sup>5</sup>/<sub>8</sub>"  
DØ46 Brave Gypsum Matt  
DØ47 Brave Pearl Matt  
DØ48 Brave Grey Matt  
DØ49 Brave Earth Matt  
DØ5Ø Brave Coke Matt

**H** HEAVY TRAFFIC  
Matte ± 9 mm  
Grip ± 9 mm  
Outdoor ± 20 mm

**R10 A+B** Matte ± 9 mm  
**R12 A+B+C** Grip ± 9 mm  
**R11 A+B+C** Outdoor ± 20 mm

V2 Slight Variation



± 9 mm

**45x90 cm** - 17<sup>3</sup>/<sub>4</sub>"x35<sup>3</sup>/<sub>8</sub>"  
AXAE Brave Gypsum Matt  
AXAF Brave Pearl Matt  
AXAG Brave Grey Matt  
AXAH Brave Earth Matt  
AXAI Brave Coke Matt

### GRIP SURFACE



± 9 mm

**30x60 cm** - 11<sup>3</sup>/<sub>4</sub>"x23<sup>5</sup>/<sub>8</sub>"  
DØ51 Brave Gypsum Grip  
DØ52 Brave Pearl Grip  
DØ53 Brave Grey Grip  
DØ54 Brave Earth Grip  
DØ55 Brave Coke Grip



### OUTDOOR ± 20 mm



± 20 mm

**120x120 cm** - 47<sup>1</sup>/<sub>4</sub>"x47<sup>1</sup>/<sub>4</sub>"  
AOX9 Brave Grey 20 mm  
AOYA Brave Coke 20 mm



± 20 mm

**60x120 cm** - 23<sup>5</sup>/<sub>8</sub>"x47<sup>1</sup>/<sub>4</sub>"  
AT5I Brave Gypsum 20 mm  
AT5J Brave Pearl 20 mm  
AT5K Brave Grey 20 mm  
AT5L Brave Earth 20 mm  
AT5M Brave Coke 20 mm



± 20 mm

**60x60 cm** - 23<sup>5</sup>/<sub>8</sub>"x23<sup>5</sup>/<sub>8</sub>"  
AXAT Brave Gypsum 20 mm  
AXAU Brave Pearl 20 mm  
AXAV Brave Grey 20 mm  
AXAW Brave Earth 20 mm  
AXAX Brave Coke 20 mm



± 20 mm

**45x90 cm** - 17<sup>3</sup>/<sub>4</sub>"x35<sup>3</sup>/<sub>8</sub>"  
AXAY Brave Gypsum 20 mm  
AXAZ Brave Pearl 20 mm  
AXBA Brave Grey 20 mm  
AXBB Brave Earth 20 mm  
AXBC Brave Coke 20 mm

**Matte surface** – Superficie matt – Surface Mat – Matte Oberfläche – Superficie Mate – Матовая поверхность  
**Grip surface** – Superficie grip – Surface grip – Grip Oberfläche – Superficie Grip – Grip поверхность  
**Outdoor** – Pavimenti da esterno – Sols d'extérieur – Bodenbeläge für Außenbereiche – Pavimentos para exteriores – Уличная плитка

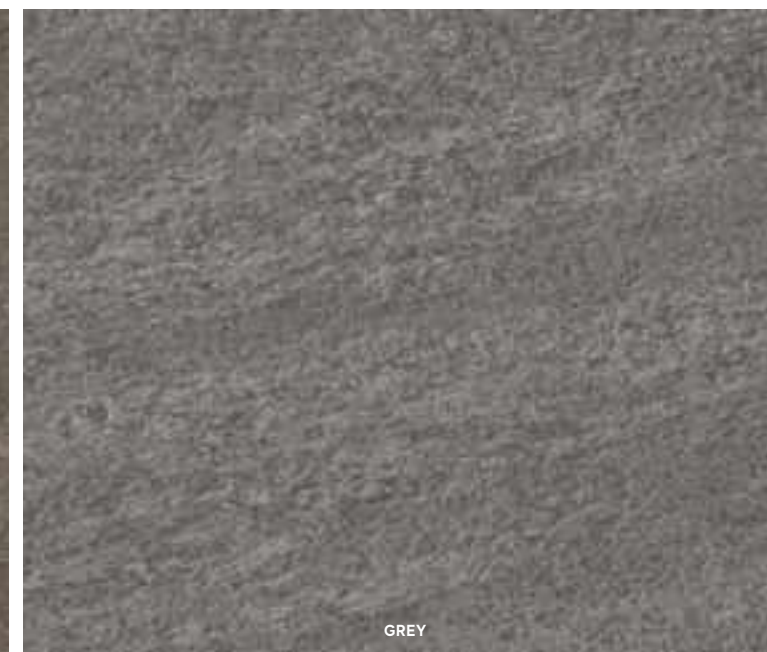

INDEX



PRODUCT  
FINDER



SURFACE  
RANGE



COMPANY



COLLECTIONS



3D WALL  
CONCRETE & RESIN LOOK  
METAL LOOK  
MARBLE LOOK

STONE LOOK

WOOD LOOK

LARGE SIZES



TECHNICAL  
SPECIFICATIONS









# Brave Wall Tiles

## MATTE SURFACE

 **± 8,5 mm**  
**40x80 cm** - 15<sup>3</sup>/<sub>8</sub>"x31<sup>1</sup>/<sub>2</sub>"  
 8BWU Brave Gypsum  
 8BWL Brave Pearl  
 8BWY Brave Grey

 **± 10 mm 3D WALL**  
**40x80 cm** - 15<sup>3</sup>/<sub>8</sub>"x31<sup>1</sup>/<sub>2</sub>"  
 8BDG Brave 3D Wave Gypsum  
 8BDP Brave 3D Wave Pearl  
 8BDE Brave 3D Wave Grey  
 8BBG Brave 3D Blade Gypsum

## TRIM TILES

LBSU Brave Gypsum Spigolo 0,8  
 0,8x20 cm - 3<sup>1</sup>/<sub>8</sub>"x7<sup>1</sup>/<sub>8</sub>"

A1BU Brave Gypsum Spigolo 0,8 A.E.  
 0,8x0,8 cm - 3<sup>1</sup>/<sub>8</sub>"x3<sup>1</sup>/<sub>8</sub>"

LBSL Brave Pearl Spigolo 0,8  
 0,8x20 cm - 3<sup>1</sup>/<sub>8</sub>"x7<sup>1</sup>/<sub>8</sub>"

A1BL Brave Pearl Spigolo 0,8 A.E.  
 0,8x0,8 cm - 3<sup>1</sup>/<sub>8</sub>"x3<sup>1</sup>/<sub>8</sub>"

LBSE Brave Grey Spigolo 0,8  
 0,8x20 cm - 3<sup>1</sup>/<sub>8</sub>"x7<sup>1</sup>/<sub>8</sub>"

A1BR Brave Grey Spigolo 0,8 A.E.  
 0,8x0,8 cm - 3<sup>1</sup>/<sub>8</sub>"x3<sup>1</sup>/<sub>8</sub>"

## 3D TRIM TILES

LB1G Brave Gypsum Spigolo 10mm \* ▲  
 1x20 cm - 3<sup>1</sup>/<sub>8</sub>"x7<sup>1</sup>/<sub>8</sub>"

LB1R Brave Pearl Spigolo 10mm \* ▲  
 1x20 cm - 3<sup>1</sup>/<sub>8</sub>"x7<sup>1</sup>/<sub>8</sub>"

LB1E Brave Grey Spigolo 10mm \* ▲  
 1x20 cm - 3<sup>1</sup>/<sub>8</sub>"x7<sup>1</sup>/<sub>8</sub>"

\* These parts are supplied to order - I pezzi sono disponibili su ordinazione - Les pièces sont disponibles sur commande - Die Teile sind auf Bestellung lieferbar - Las piezas se hacen por encargo - Изготавливаются на заказ

▲The 10 mm edge matches three-dimensional wall tiles having a 10-11 mm thickness - Lo spigolo 10 mm si abbina a rivestimenti tridimensionali di spessore 10-11 mm- Le bord 10 mm s'adapte aux revêtements tridimensionnels épaisseur 10-11 mm - Die 10 mm Kante ist mit dreidimensionalen Wandfliesen mit einer Dicke von 10-11 mm kombinierbar - La arista de 10 mm se combina con revestimientos tridimensionales de 10 -11 mm de grosor - Угловой элемент 10 мм сочетается с трехмерной настенной плиткой толщиной 10-11 мм

Matte surface - Superficie matt - Surface Mat - Matte Oberfläche - Superficie Mate - Матовая поверхность



GYPSUM



3D WAVE GYPSUM



PEARL



3D WAVE PEARL



GREY



3D WAVE GREY



3D BLADE GYPSUM

## DECOR RANGE



9BBG Brave Gypsum Mosaic  
 30,5x30,5 - 12"x12"



9BBP Brave Pearl Mosaic  
 30,5x30,5 - 12"x12"



9BBE Brave Grey Mosaic  
 30,5x30,5 - 12"x12"

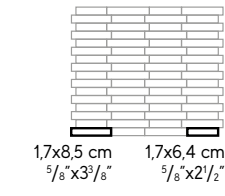

© Ceramiche Atlas Concorde

INDEX



PRODUCT  
FINDER



SURFACE  
RANGE



COMPANY



COLLECTIONS



- 3D WALL
- CONCRETE & RESIN LOOK
- METAL LOOK
- MARBLE LOOK
- STONE LOOK
- WOOD LOOK

LARGE SIZES



TECHNICAL  
SPECIFICATIONS



# Dolmen Pro

DOWNLOAD >  
CATALOG &  
IMAGE GALLERY

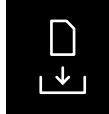

© Ceramiche Atlas Concorde



© Ceramiche Atlas Concorde



© Ceramiche Atlas Concorde

## Porcelain Tiles



### COLOURED BODY PORCELAIN TILES - RECTIFIED MONOCALIBER

Sizes	Thickness	Surface finish
162x324 cm - 63 <sup>3</sup> / <sub>4</sub> "x127 <sup>1</sup> / <sub>2</sub> " NON RECTIFIED	± 12-20 mm	Flamed
37,5x75 cm - 14 <sup>3</sup> / <sub>4</sub> "x29 <sup>1</sup> / <sub>2</sub> "	± 9 mm	Matte R10 A+B

LARGE SIZES p. 390

### OUTDOOR PAVING AND WET AREAS

Sizes	Thickness	Surface finish
37,5x75 cm - 14 <sup>3</sup> / <sub>4</sub> "x29 <sup>1</sup> / <sub>2</sub> "	± 9 mm	Grip R11 A+B+C
22,5x45,3 cm - 8 <sup>7</sup> / <sub>8</sub> "x17 <sup>3</sup> / <sub>4</sub> " NON RECTIFIED	± 9 mm	Textured R11 A+B+C
22,5x22,5 cm - 8 <sup>7</sup> / <sub>8</sub> "x8 <sup>7</sup> / <sub>8</sub> " NON RECTIFIED	± 9 mm	Textured R11 A+B+C
60x120 cm - 23 <sup>5</sup> / <sub>8</sub> "x47 <sup>1</sup> / <sub>4</sub> "	± 20 mm	Outdoor R11 A+B+C
22,5x45,4 cm - 8 <sup>7</sup> / <sub>8</sub> "x17 <sup>3</sup> / <sub>4</sub> " NON RECTIFIED	± 20 mm	Outdoor R11 A+B+C
22,5x22,5 cm - 8 <sup>7</sup> / <sub>8</sub> "x8 <sup>7</sup> / <sub>8</sub> " NON RECTIFIED	± 20 mm	Outdoor R11 A+B+C

INDEX



PRODUCT  
FINDER



SURFACE  
RANGE



COMPANY



COLLECTIONS



- 3D WALL
- CONCRETE & RESIN LOOK
- METAL LOOK
- MARBLE LOOK
- STONE LOOK
- WOOD LOOK

LARGE SIZES



TECHNICAL  
SPECIFICATIONS



Coloured body porcelain tiles - Gres porcellanato colorato in massa - Grès cérame coloré dans la masse - Durchgefärbtes Feinsteinzeug - Gres porcelánico coloreado en masa - Керамический гранит окрашенный в массу  
Rectified monocaliber - Rettificato monocalibro - Rectifié mono-calibre - Geschliffen einkalbrig - Rectificado monocalibre - Ретифицированный в одном калибре  
Non rectified - Non rettificato - Non rectifié - Nicht rektifiziert - No rectificada - Неретифицированные

# Dolmen Pro

## Porcelain Tiles

### MATTE SURFACE



± 9 mm

37,5x75 cm - 14<sup>3</sup>/<sub>8</sub>"x29<sup>1</sup>/<sub>2</sub>"

APP4 Dolmen Pro Cenere Matt

APP5 Dolmen Pro Grigio Matt

APP6 Dolmen Pro Rosso Matt

APP7 Dolmen Pro Mix Matt

### GRIP SURFACE



± 9 mm

37,5x75 cm - 14<sup>3</sup>/<sub>8</sub>"x29<sup>1</sup>/<sub>2</sub>"

APP8 Dolmen Pro Cenere Grip

APP9 Dolmen Pro Grigio Grip

APQA Dolmen Pro Rosso Grip

APQB Dolmen Pro Mix Grip

### TEXTURED SURFACE



± 9 mm

22,5x45,3 cm - 8<sup>7</sup>/<sub>8</sub>"x17<sup>3</sup>/<sub>8</sub>"

NON RECTIFIED

APQG Dolmen Pro Cenere Strutturato

APQH Dolmen Pro Grigio Strutturato

APQI Dolmen Pro Rosso Strutturato

APQJ Dolmen Pro Mix Strutturato



± 9 mm

22,5x22,5 cm - 8<sup>7</sup>/<sub>8</sub>"x8<sup>7</sup>/<sub>8</sub>"

NON RECTIFIED

APQC Dolmen Pro Cenere Strutturato

APQD Dolmen Pro Grigio Strutturato

APQE Dolmen Pro Rosso Strutturato

APQF Dolmen Pro Mix Strutturato

### OUTDOOR ± 20 mm



± 20 mm

60x120 cm - 23<sup>5</sup>/<sub>8</sub>"x47<sup>1</sup>/<sub>8</sub>"

APQP Dolmen Pro Cenere 20 mm

APQQ Dolmen Pro Grigio 20 mm

APQS Dolmen Pro Rosso 20 mm



± 20 mm

22,5x45,4 cm - 8<sup>7</sup>/<sub>8</sub>"x17<sup>3</sup>/<sub>8</sub>"

NON RECTIFIED

APQK Dolmen Pro Rosso 20 mm

APQL Dolmen Pro Mix 20 mm



± 20 mm

22,5x22,5 cm - 8<sup>7</sup>/<sub>8</sub>"x8<sup>7</sup>/<sub>8</sub>"

NON RECTIFIED

APQN Dolmen Pro Rosso 20 mm

APQO Dolmen Pro Mix 20 mm

### TRIM TILES

p. 462



p. 455

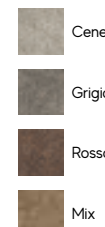

#### Battiscopa

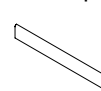

7,2x75 cm  
2<sup>7</sup>/<sub>8</sub>"x29<sup>1</sup>/<sub>2</sub>"  
Matt

AØU1  
AØU2  
AØU3  
AØU4

#### Gradino \*

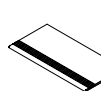

37,5x75 cm  
14<sup>3</sup>/<sub>8</sub>"x29<sup>1</sup>/<sub>2</sub>"  
Matt

AØVE  
AØVF  
AØVG  
AØVH

#### Scalino \*

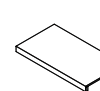

37,5x75 cm  
14<sup>3</sup>/<sub>8</sub>"x29<sup>1</sup>/<sub>2</sub>"  
Matt

AØVL  
AØVM  
AØVN  
AØVO

#### Scalin Ang.\*

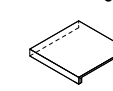

37,5x37,5 cm  
14<sup>3</sup>/<sub>8</sub>"x14<sup>3</sup>/<sub>8</sub>"  
Matt

AØVP  
AØVQ  
AØVR  
AØVS

#### Battiscopa Sag. Scala \*



7,2x30 cm  
2<sup>7</sup>/<sub>8</sub>"x11<sup>1</sup>/<sub>2</sub>"  
Matt

DX SX  
AØU5 AØU9  
AØU6 AØVB  
AØU7 AØVC  
AØU8 AØVD

#### Elemento L Grip \*

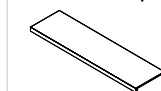

15x75 H. 4 cm  
5<sup>7</sup>/<sub>8</sub>"x29<sup>1</sup>/<sub>2</sub>" H. 1<sup>1</sup>/<sub>8</sub>"  
Matt

AØVT  
AØVU  
AØVV  
AØVW

#### Elemento L Strutt. \*

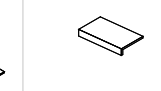

15x30 H. 3,5 cm  
5<sup>7</sup>/<sub>8</sub>"x11<sup>1</sup>/<sub>2</sub>" H. 1<sup>1</sup>/<sub>8</sub>"  
Matt

AØ4P  
AØ4Q  
AØTV  
AØTY

\* These parts are supplied to order - I pezzi sono disponibili su ordinazione - Les pièces sont disponibles sur commande - Die Teile sind auf Bestellung lieferbar - Las piezas se hacen por encargo - Изготавливаются на заказ

\* Cenere, Grigio, Rosso  
\*\* Mix

**Matte surface** - Superficie matt - Surface Mat - Matte Oberfläche - Superficie Mate - Матовая поверхность  
**Grip surface** - Superficie grip - Surface grip - Grip Oberfläche - Superficie Grip - Grip поверхность  
**Textured surface** - Superficie strutturata - Surface structuré - Strukturierte Oberfläche - Superficie estructurado - Структурная поверхность  
**Outdoor** - Pavimenti da esterno - Sols d'extérieur - Bodenbeläge für Außenbereiche - Pavimentos para exteriores - Уличная плитка



INDEX



PRODUCT  
FINDER



SURFACE  
RANGE



COMPANY



COLLECTIONS



- 3D WALL
- CONCRETE & RESIN LOOK
- METAL LOOK
- MARBLE LOOK
- STONE LOOK
- WOOD LOOK

LARGE SIZES



TECHNICAL  
SPECIFICATIONS



# Dolmen Pro

## Porcelain Tiles

### DECOR RANGE

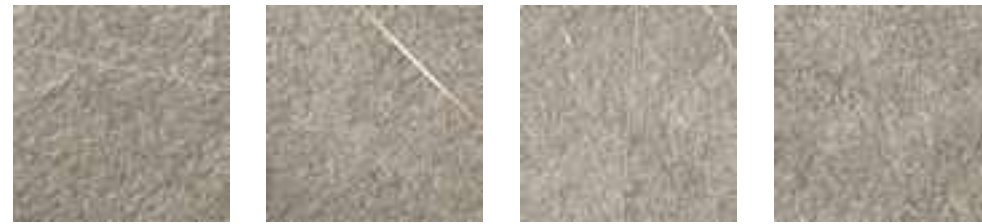

AØ2X Dolmen Pro Cenera  
Squares Mix 4 ♦  
34x34 - 13<sup>3</sup>/<sub>8</sub>"x13<sup>3</sup>/<sub>8</sub>"

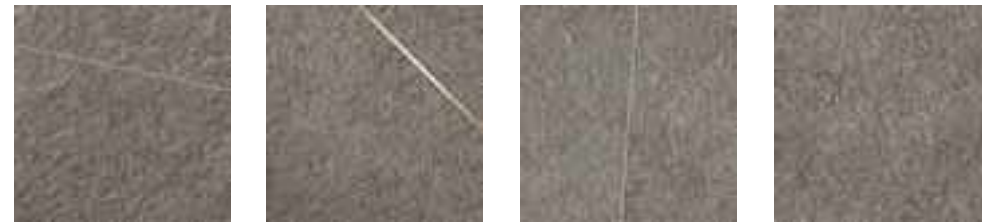

AØ2Y Dolmen Pro Grigio  
Squares Mix 4 ♦  
34x34 - 13<sup>3</sup>/<sub>8</sub>"x13<sup>3</sup>/<sub>8</sub>"



AØ2Z Dolmen Pro Rosso  
Squares Mix 4 ♦  
34x34 - 13<sup>3</sup>/<sub>8</sub>"x13<sup>3</sup>/<sub>8</sub>"

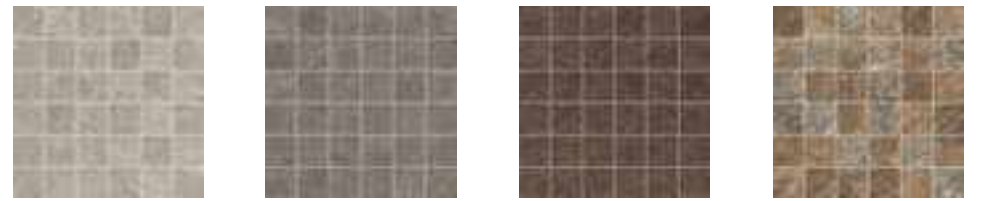

AØ2H Dolmen Pro Cenera  
Mosaico  
30x30 - 11<sup>1</sup>/<sub>4</sub>"x11<sup>1</sup>/<sub>4</sub>"

AØ2J Dolmen Pro Grigio  
Mosaico  
30x30 - 11<sup>1</sup>/<sub>4</sub>"x11<sup>1</sup>/<sub>4</sub>"

AØ2K Dolmen Pro Rosso  
Mosaico  
30x30 - 11<sup>1</sup>/<sub>4</sub>"x11<sup>1</sup>/<sub>4</sub>"

AØ2L Dolmen Pro Mix  
Mosaico  
30x30 - 11<sup>1</sup>/<sub>4</sub>"x11<sup>1</sup>/<sub>4</sub>"

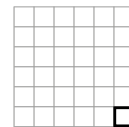
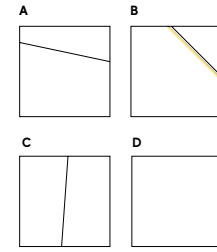

4,8x4,8 cm  
2"x2"



AØ2M Dolmen Pro Cenera  
Brick  
37,5x75 - 14<sup>3</sup>/<sub>4</sub>"x29<sup>1</sup>/<sub>2</sub>"



AØ2N Dolmen Pro Grigio  
Brick  
37,5x75 - 14<sup>3</sup>/<sub>4</sub>"x29<sup>1</sup>/<sub>2</sub>"

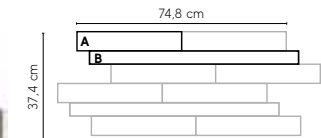

A 7 x 37,3 cm - 2<sup>7</sup>/<sub>8</sub>"x14<sup>3</sup>/<sub>4</sub>"  
B 4,2 x 74,8 cm - 1<sup>7</sup>/<sub>8</sub>"x 29<sup>1</sup>/<sub>2</sub>"



AØ2O Dolmen Pro Rosso  
Brick  
37,5x75 - 14<sup>3</sup>/<sub>4</sub>"x29<sup>1</sup>/<sub>2</sub>"



AØ2Q Dolmen Pro Mix  
Brick  
37,5x75 - 14<sup>3</sup>/<sub>4</sub>"x29<sup>1</sup>/<sub>2</sub>"

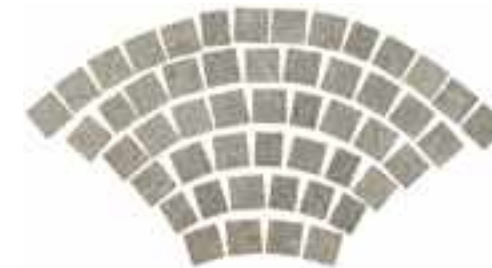

AØ2R Dolmen Pro Cenera  
Coda di Pavone Grip  
53,2x102,8 - 20<sup>7</sup>/<sub>8</sub>"x40<sup>1</sup>/<sub>2</sub>" ▲

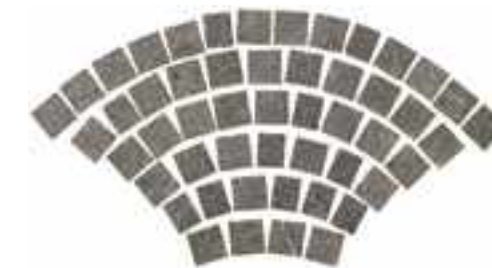

AØ2T Dolmen Pro Grigio  
Coda di Pavone Grip  
53,2x102,8 - 20<sup>7</sup>/<sub>8</sub>"x40<sup>1</sup>/<sub>2</sub>" ▲

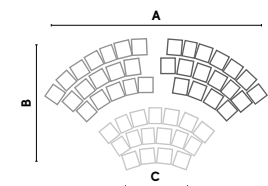

A 102,8 cm - 40<sup>1</sup>/<sub>2</sub>"  
B 53,2 cm - 20<sup>7</sup>/<sub>8</sub>"  
C 30,5 cm - 12"



AØ2U Dolmen Pro Rosso  
Coda di Pavone Grip  
53,2x102,8 - 20<sup>7</sup>/<sub>8</sub>"x40<sup>1</sup>/<sub>2</sub>" ▲



AØ2V Dolmen Pro Mix  
Coda di Pavone Grip  
53,2x102,8 - 20<sup>7</sup>/<sub>8</sub>"x40<sup>1</sup>/<sub>2</sub>" ▲



AØ2W Dolmen Pro Cenera-Rosso  
Coda di Pavone Grip  
53,2x102,8 - 20<sup>7</sup>/<sub>8</sub>"x40<sup>1</sup>/<sub>2</sub>" ▲

♦ **Metal insert. We recommend use of a neutral detergent. Do not use acid, alkaline or waxing products or metal scouring pads.** - Insetto metallico. Si consiglia l'utilizzo di un comune detergente neutro, evitare l'utilizzo di prodotti acidi o alcalini, ceranti e pagliette di metallo. - Inset métallique. Il est conseillé d'utiliser un produit détergent commun et neutre, d'éviter d'utiliser des produits acides ou alcalins, à base de cire ainsi que les pailles de métal - Metalleinlage. Ein handelsübliches, neutrales Reinigungsmittel und keine sauren oder alkalischen, wachshaltigen Produkte oder Stahlwolle verwenden. - Inseto metálico. Se recomienda utilizar un detergente neutro y evitar productos ácidos o alcalinos, ceras y estropajos metálicos. - Металлическая вставка. Рекомендуется использовать обычное нейтральное моющее средство, избегать использования кислотных или щелочных продуктов, а также средств для вощения и металлических мочалок.

■ **The decoration can only be laid on the wall** - Il decoro si può posare solo a rivestimento - Décor uniquement mural - Das Dekor kann nur an der Wand verlegt werden  
La decoración se puede colocar únicamente en paredes - Декор может быть уложен только на стену.

▲ **The miniatures are not in proportion** - I minimali non sono in proporzione. - Les illustrations à échelle réduite ne sont pas proportionnelles. - Die Abbildungen sind nicht verhältnismäßig. - Los miniaturas no están en proporción. n- Изображения не соблюдают пропорций.

INDEX



PRODUCT  
FINDER



SURFACE  
RANGE



COMPANY



COLLECTIONS



- 3D WALL
- CONCRETE & RESIN LOOK
- METAL LOOK
- MARBLE LOOK
- STONE LOOK
- WOOD LOOK

LARGE SIZES



TECHNICAL  
SPECIFICATIONS



# Klif

DOWNLOAD >  
CATALOG &  
IMAGE GALLERY

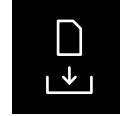

ENJOY THE  
VIDEO

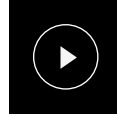

© Ceramiche Atlas Concorde



© Ceramiche Atlas Concorde



© Ceramiche Atlas Concorde

## Porcelain Tiles



### COLOURED BODY PORCELAIN TILES - RECTIFIED MONOCALIBER

Sizes	Thickness	Surface finish
75x150 cm - 29 1/2" x 59"	± 9 mm	Matte R10 A+B
75x75 cm - 29 1/2" x 29 1/2"	± 9 mm	Matte R10 A+B
37,5x75 cm - 14 3/4" x 29 1/2"	± 9 mm	Matte R10 A+B

### OUTDOOR PAVING AND WET AREAS

Sizes	Thickness	Surface finish
37,5x75 cm - 14 3/4" x 29 1/2"	± 9 mm	Grip R11 A+B+C
90x90 cm - 35 3/8" x 35 3/8"	± 20 mm	Outdoor R11 A+B+C
45x90 cm - 17 3/4" x 35 3/8"	± 20 mm	Outdoor R11 A+B+C
60x60 cm - 23 5/8" x 23 5/8"	± 20 mm	Outdoor R11 A+B+C

## Wall Tiles



### WHITEBODY WALL TILES - RECTIFIED MONOCALIBER

Sizes	Thickness	Surface finish
40x80 cm - 15 3/4" x 31 1/2"	± 8,5 mm	Matte
<b>3D WALL TILES</b>		
40x80 cm - 15 3/4" x 31 1/2"	± 10 mm	Matte

**Coloured body porcelain tiles** – Gres porcellanato colorato in massa – Grès cérame coloré dans la masse – Durchgefärbtes Feinsteinzeug – Gres porcelánico coloreado en masa – Керамический гранит окрашенный в массе  
**Whitebody wall tiles** – Rivestimenti in pasta bianca – Revêtements en pâte blanche – Weißscherbige Wandfliesen – Revestimientos en pasta blanca – Настенная плитка из белой глины  
**Rectified monocaliber** – Rettificato monocalibro – Rectifié mono-calibre – Geschliffen einkalbrig – Rectificado monocalibre – Ретифицированный в одном калибре

INDEX



PRODUCT  
FINDER



SURFACE  
RANGE



COMPANY



COLLECTIONS



- 3D WALL
- CONCRETE & RESIN LOOK
- METAL LOOK
- MARBLE LOOK
- STONE LOOK
- WOOD LOOK

LARGE SIZES



TECHNICAL  
SPECIFICATIONS



# Klif

## Porcelain Tiles

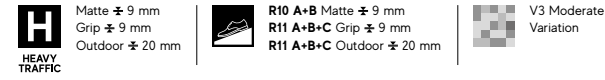

### MATTE SURFACE



± 9 mm  
**75x150 cm** - 29<sup>1</sup>/<sub>2</sub>"x59"  
 A7HJ Klif White Matt  
 A7HK Klif Silver Matt  
 A7HL Klif Grey Matt  
 A7HM Klif Dark Matt



± 9 mm  
**75x75 cm** - 29<sup>1</sup>/<sub>2</sub>"x29<sup>1</sup>/<sub>2</sub>"  
 ANXS Klif White Matt  
 ANXT Klif Silver Matt  
 ANXU Klif Grey Matt  
 ANXV Klif Dark Matt



± 9 mm  
**37,5x75 cm** - 14<sup>3</sup>/<sub>4</sub>"x29<sup>1</sup>/<sub>2</sub>"  
 ANXW Klif White Matt  
 ANXX Klif Silver Matt  
 ANXY Klif Grey Matt  
 ANXZ Klif Dark Matt



### GRIP SURFACE



± 9 mm  
**37,5x75 cm** - 14<sup>3</sup>/<sub>4</sub>"x29<sup>1</sup>/<sub>2</sub>"  
 ANXØ Klif White Grip  
 ANX1 Klif Silver Grip  
 ANX2 Klif Grey Grip  
 ANX3 Klif Dark Grip



### OUTDOOR ± 20 mm



± 20 mm  
**90x90 cm** - 35<sup>3</sup>/<sub>8</sub>"x35<sup>3</sup>/<sub>8</sub>"  
 AOES Klif Silver 20 mm  
 AOET Klif Grey 20 mm  
 AOEU Klif Dark 20 mm



± 20 mm  
**45x90 cm** - 17<sup>3</sup>/<sub>4</sub>"x35<sup>3</sup>/<sub>8</sub>"  
 ANX7 Klif Silver 20 mm  
 ANX8 Klif Grey 20 mm  
 ANX9 Klif Dark 20 mm



± 20 mm  
**60x60 cm** - 23<sup>5</sup>/<sub>8</sub>"x23<sup>5</sup>/<sub>8</sub>"  
 ANX4 Klif Silver 20 mm  
 ANX5 Klif Grey 20 mm  
 ANX6 Klif Dark 20 mm



MATTE / GRIP



WHITE



SILVER



GREY



DARK

OUTDOOR 20 mm



SILVER



GREY



DARK

### TRIM TILES p. 462

	Battiscopa	Gradino *	Scalino *	Scalino *	Scalin Ang.*	Battiscopa Sag. Scala *	Elemento L
	7,2x7,5 cm 2 <sup>7</sup> / <sub>8</sub> "x29 <sup>1</sup> / <sub>2</sub> " Matt	37,5x7,5 cm 14 <sup>1</sup> / <sub>4</sub> "x29 <sup>1</sup> / <sub>2</sub> " Matt	37,5x15,0 cm 14 <sup>1</sup> / <sub>4</sub> "x59"	37,5x7,5 cm 14 <sup>1</sup> / <sub>4</sub> "x29 <sup>1</sup> / <sub>2</sub> " Matt	37,5x37,5 cm 14 <sup>1</sup> / <sub>4</sub> "x14 <sup>1</sup> / <sub>4</sub> " Matt	7,2x30 cm 2 <sup>7</sup> / <sub>8</sub> "x11 <sup>7</sup> / <sub>8</sub> " Matt	15x7,5 H 4 cm 5 <sup>7</sup> / <sub>8</sub> "x29 <sup>1</sup> / <sub>2</sub> " H.1 <sup>7</sup> / <sub>8</sub> " Grip
	AN4F	AN4P	AN4T	AN4X	AN42	DX	AN5A
	AN2R	AN4Q	AN4U	AN4Y	AN43	AN4H	AN5B
	AN2S	AMG4	AN4V	AN4Z	AN44	AN4I	AN5C
	AN4G	AMS	AN4W	AN41	AN45	AN4J	AN5D
						SX	
						AN4K	
						AN4L	
						AN4M	
						AN4N	
						AN4O	

\* These parts are supplied to order - I pezzi sono disponibili su ordinazione - Les pièces sont disponibles sur commande - Die Teile sind auf Bestellung lieferbar - Las piezas se hacen por encargo - Изготавливаются на заказ

Matte surface - Superficie matt - Surface Mat - Matte Oberfläche - Superficie Mate - Матовая поверхность  
 Grip surface - Superficie grip - Surface grip - Grip Oberfläche - Superficie Grip - Grip поверхность  
 Outdoor - pavimenti da esterno - Sols d'extérieur - Bodenbeläge für Außenbereiche - Pavimentos para exteriores - Уличная плитка

INDEX



PRODUCT  
FINDER



SURFACE  
RANGE



COMPANY



COLLECTIONS



- 3D WALL
- CONCRETE & RESIN LOOK
- METAL LOOK
- MARBLE LOOK
- STONE LOOK
- WOOD LOOK

LARGE SIZES



TECHNICAL  
SPECIFICATIONS



# Klif

## Porcelain Tiles

### DECOR RANGE



AN46 Klif White  
Mosaico  
30x30 - 1<sup>1</sup>/<sub>4</sub>"x1<sup>1</sup>/<sub>4</sub>"



AN47 Klif Silver  
Mosaico  
30x30 - 1<sup>1</sup>/<sub>4</sub>"x1<sup>1</sup>/<sub>4</sub>"



AN48 Klif Grey  
Mosaico  
30x30 - 1<sup>1</sup>/<sub>4</sub>"x1<sup>1</sup>/<sub>4</sub>"

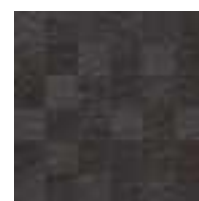

AN49 Klif Dark  
Mosaico  
30x30 - 1<sup>1</sup>/<sub>4</sub>"x1<sup>1</sup>/<sub>4</sub>"

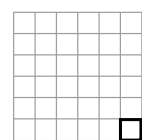

4,8x4,8 cm  
1<sup>7</sup>/<sub>8</sub>"x1<sup>7</sup>/<sub>8</sub>"



AN7G Klif White  
Triangles  
28,5x33 - 11<sup>1</sup>/<sub>4</sub>"x13"



AN7H Klif Silver  
Triangles  
28,5x33 - 11<sup>1</sup>/<sub>4</sub>"x13"



AN7I Klif Grey  
Triangles  
28,5x33 - 11<sup>1</sup>/<sub>4</sub>"x13"



AN7J Klif Dark  
Triangles  
28,5x33 - 11<sup>1</sup>/<sub>4</sub>"x13"

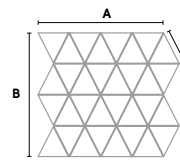

A 32,8 cm - 13"  
B 28,5 cm - 11<sup>1</sup>/<sub>4</sub>"  
C 7,9 cm - 3<sup>1</sup>/<sub>8</sub>"



AN7C Klif White  
Brick  
37,5x75 - 14<sup>3</sup>/<sub>4</sub>"x29<sup>1</sup>/<sub>2</sub>"



AN7D Klif Silver  
Brick  
37,5x75 - 14<sup>3</sup>/<sub>4</sub>"x29<sup>1</sup>/<sub>2</sub>"

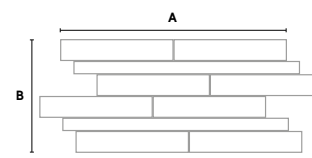

A 74,8 cm - 29<sup>1</sup>/<sub>2</sub>"  
B 37,4 cm - 14<sup>3</sup>/<sub>4</sub>"



AN7E Klif Grey  
Brick  
37,5x75 - 14<sup>3</sup>/<sub>4</sub>"x29<sup>1</sup>/<sub>2</sub>"



AN7F Klif Dark  
Brick  
37,5x75 - 14<sup>3</sup>/<sub>4</sub>"x29<sup>1</sup>/<sub>2</sub>"



AN7K Klif White  
Brick 3D  
28x55 - 11"x21<sup>5</sup>/<sub>8</sub>"



AN7L Klif Silver  
Brick 3D  
28x55 - 11"x21<sup>5</sup>/<sub>8</sub>"

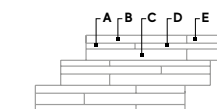

A 18x2,1 cm - 7<sup>1</sup>/<sub>8</sub>"x1<sup>1</sup>/<sub>8</sub>"  
B 37x2,9 cm - 14<sup>3</sup>/<sub>8</sub>"x1<sup>1</sup>/<sub>8</sub>"  
C 37x4,2 cm - 14<sup>5</sup>/<sub>8</sub>"x1<sup>1</sup>/<sub>8</sub>"  
D 37x2,1 cm - 14<sup>5</sup>/<sub>8</sub>"x1<sup>1</sup>/<sub>8</sub>"  
E 18x2,9 cm - 7<sup>1</sup>/<sub>8</sub>"x1<sup>1</sup>/<sub>8</sub>"  
F 18x4,2 cm - 7<sup>1</sup>/<sub>8</sub>"x1<sup>1</sup>/<sub>8</sub>"



AN7M Klif Grey  
Brick 3D  
28x55 - 11"x21<sup>5</sup>/<sub>8</sub>"



AN7N Klif Dark  
Brick 3D  
28x55 - 11"x21<sup>5</sup>/<sub>8</sub>"

INDEX



PRODUCT  
FINDER



SURFACE  
RANGE



COMPANY



COLLECTIONS



- 3D WALL
- CONCRETE & RESIN LOOK
- METAL LOOK
- MARBLE LOOK
- STONE LOOK
- WOOD LOOK

LARGE SIZES



TECHNICAL  
SPECIFICATIONS



The decoration can only be laid on the wall - Il decoro si può posare solo a rivestimento - Décor uniquement mural - Das Dekor kann nur an der Wand verlegt werden  
La decoración se puede colocar únicamente en paredes - Декор может быть уложен только на стену.

# Klif Wall Tiles

## MATTE SURFACE



± 8.5 mm  
40x80 cm - 15<sup>3</sup>/<sub>4</sub>"x31<sup>1</sup>/<sub>2</sub>"  
8K8W Klif White  
8K8S Klif Silver  
8K8G Klif Grey

± 10 mm 3D WALL  
40x80 cm - 15<sup>3</sup>/<sub>4</sub>"x31<sup>1</sup>/<sub>2</sub>"  
8KRW Klif 3D Row White  
8KRS Klif 3D Row Silver  
8KRG Klif 3D Row Grey

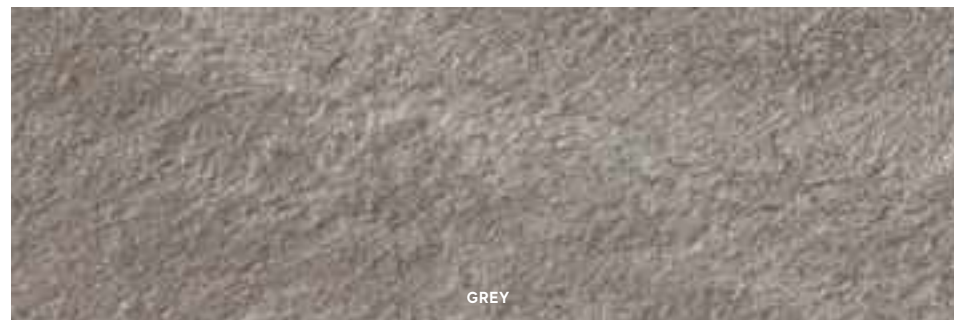

## TRIM TILES

1,4x40 cm - 5<sup>5</sup>/<sub>16</sub>"x15<sup>1</sup>/<sub>4</sub>"  
LK4W Klif White Corner 40 \*  
LK4S Klif Silver Corner 40 \*  
LK4G Klif Grey Corner 40 \*

1,4x1,4 cm - 5<sup>5</sup>/<sub>16</sub>"x5<sup>5</sup>/<sub>16</sub>"  
AKCW Klif White Corner A.E. \*  
AKCL Klif Silver Corner A.E. \*  
AKCG Klif Grey Corner A.E. \*

## 3D TRIM TILES

1,4x40 cm - 5<sup>5</sup>/<sub>16</sub>"x15<sup>1</sup>/<sub>4</sub>"  
LY3W Klif White 3D Corner 40 \*  
LY3S Klif Silver 3D Corner 40 \*  
LY3G Klif Grey 3D Corner 40 \*

1,4x1,4 cm - 5<sup>5</sup>/<sub>16</sub>"x5<sup>5</sup>/<sub>16</sub>"  
AK3W Klif White Corner A.E. \*  
AK3S Klif Silver Corner A.E. \*  
AK3G Klif Grey Corner A.E. \*

\* These parts are supplied to order - I pezzi sono disponibili su ordinazione - Les pièces sont disponibles sur commande - Die Teile sind auf Bestellung lieferbar - Las piezas se hacen por encargo - Изготавливаются на заказ  
Matte surface - Superficie matt - Surface Mat - Matte Oberfläche - Superficie Mate - Матовая поверхность

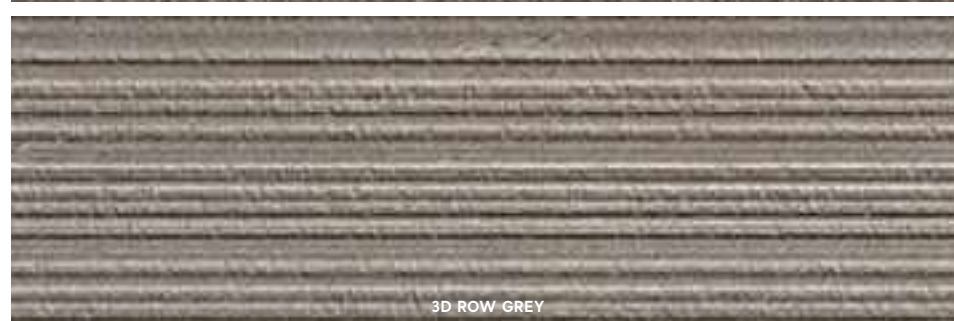
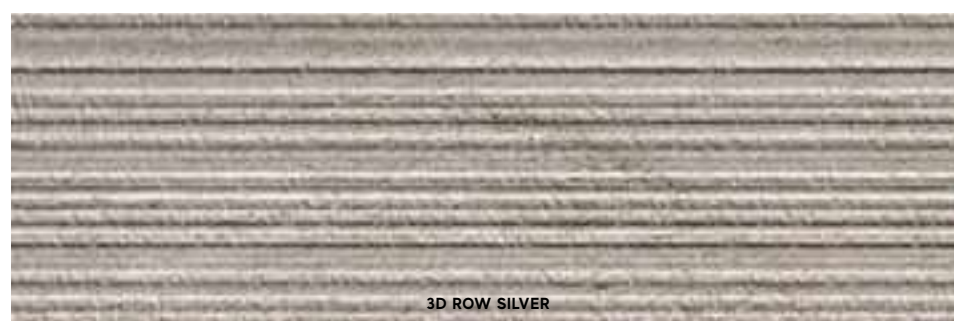
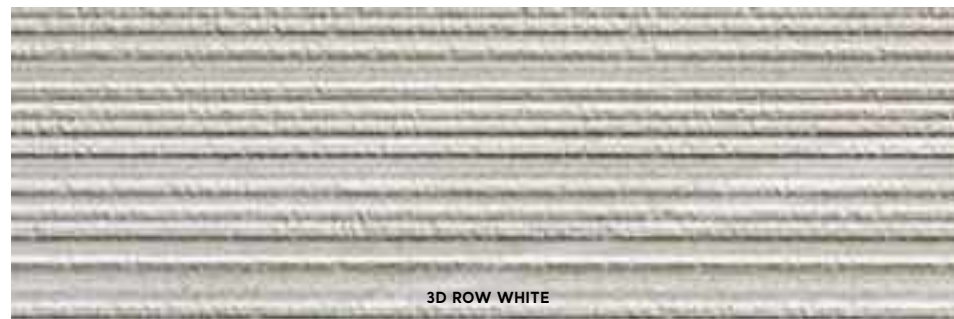

INDEX

PRODUCT FINDER

SURFACE RANGE

COMPANY

COLLECTIONS

- 3D WALL
- CONCRETE & RESIN LOOK
- METAL LOOK
- MARBLE LOOK
- STONE LOOK
- WOOD LOOK

LARGE SIZES

TECHNICAL SPECIFICATIONS



# Kone

DOWNLOAD >  
CATALOG &  
IMAGE GALLERY



© Ceramiche Atlas Concorde



© Ceramiche Atlas Concorde



© Ceramiche Atlas Concorde

## Porcelain Tiles



### COLOURED BODY PORCELAIN TILES - RECTIFIED MONOCALIBER

Sizes	Thickness	Surface finish
162x324 cm - 63 <sup>3</sup> / <sub>4</sub> "x127 <sup>1</sup> / <sub>2</sub> " NON RECTIFIED	± 6-12 mm	Hammered
120x120 cm - 47 <sup>1</sup> / <sub>4</sub> "x47 <sup>1</sup> / <sub>4</sub> "	± 9 mm	Matte R10 A
75x150 cm - 29 <sup>1</sup> / <sub>2</sub> "x59"	± 9 mm	Matte R10 A
75x75 cm - 29 <sup>1</sup> / <sub>2</sub> "x29 <sup>1</sup> / <sub>2</sub> "	± 9 mm	Matte R10 A
60x60 cm - 23 <sup>3</sup> / <sub>8</sub> "x23 <sup>3</sup> / <sub>8</sub> "	± 9 mm	Matte R10 A
30x60 cm - 11 <sup>1</sup> / <sub>4</sub> "x23 <sup>3</sup> / <sub>8</sub> "	± 9 mm	Matte R10 A

LARGE SIZES p. 390

### OUTDOOR PAVING AND WET AREAS

Sizes	Thickness	Surface finish
30x60 cm - 11 <sup>1</sup> / <sub>4</sub> "x23 <sup>3</sup> / <sub>8</sub> "	± 9 mm	Grip R11 A+B

INDEX



PRODUCT  
FINDER



SURFACE  
RANGE



COMPANY



COLLECTIONS



- 3D WALL
- CONCRETE & RESIN LOOK
- METAL LOOK
- MARBLE LOOK
- STONE LOOK
- WOOD LOOK

LARGE SIZES



TECHNICAL  
SPECIFICATIONS



Coloured body porcelain tiles - Gres porcellanato colorato in massa - Grès cérame coloré dans la masse - Durchgefärbtes Feinsteinzeug - Gres porcelánico coloreado en masa - Керамический гранит окрашенный в массе  
 Rectified monocaliber - Rettificato monocalibro - Rectifié mono-calibre - Geschliffen einkalbrig - Rectificado monocalibre - Ретифицированный в одном калибре  
 Non rectified - Non rettificato - Non rectifié - Nicht rektifiziert - No rectificada - Неретифицированные

# Kone

## Porcelain Tiles

### MATTE SURFACE

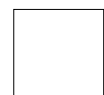

**± 9 mm**  
**120x120 cm** - 47<sup>1</sup>/<sub>4</sub>"x47<sup>1</sup>/<sub>4</sub>"  
 AULO Kone White  
 AULP Kone Pearl  
 AULQ Kone Grey



**± 9 mm**  
**60x60 cm** - 23<sup>5</sup>/<sub>8</sub>"x23<sup>5</sup>/<sub>8</sub>"  
 AUK8 Kone White  
 AUK9 Kone Beige  
 AULA Kone Silver  
 AULB Kone Pearl  
 AULC Kone Grey



**± 9 mm**  
**30x60 cm** - 11<sup>3</sup>/<sub>4</sub>"x23<sup>5</sup>/<sub>8</sub>"  
 D216 Kone White  
 D217 Kone Beige  
 D218 Kone Silver  
 D219 Kone Pearl  
 D220 Kone Grey

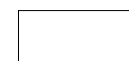

**± 9 mm**  
**75x150 cm** - 29<sup>1</sup>/<sub>2</sub>"x59"  
 A7HN Kone White  
 A7HO Kone Beige  
 A7HP Kone Silver  
 A7HQ Kone Pearl  
 A7HR Kone Grey  
 A7HS Kone Mix



**± 9 mm**  
**75x75 cm** - 29<sup>1</sup>/<sub>2</sub>"x29<sup>1</sup>/<sub>2</sub>"  
 AUKT Kone White  
 AUKU Kone Beige  
 AUKV Kone Silver  
 AUKW Kone Pearl  
 AUKX Kone Grey

### GRIP SURFACE



**± 9 mm**  
**30x60 cm** - 11<sup>3</sup>/<sub>4</sub>"x23<sup>5</sup>/<sub>8</sub>"  
 D221 Kone White Grip  
 D222 Kone Beige Grip  
 D223 Kone Silver Grip  
 D224 Kone Pearl Grip  
 D225 Kone Grey Grip



Matte ± 9 mm  
 Grip ± 9 mm



R10 A Matte ± 9 mm  
 R11 A+B Grip ± 9 mm



V2 Slight  
 Variation



atlas-PLAN  
 p. 390



**HAMMERED**  
**162x324 cm** - 63<sup>1</sup>/<sub>4</sub>"x127<sup>1</sup>/<sub>2</sub>"  
 NON RECTIFIED



### TRIM TILES

p. 462

	Battiscopa	Gradino *	Scalino *	Scalino *	Scalin Ang.*	Battiscopa Sag. Scala *	Elemento L *
	72x60 cm 2 <sup>7</sup> / <sub>8</sub> "x23 <sup>3</sup> / <sub>8</sub> " Matt	30x60 cm 11 <sup>1</sup> / <sub>4</sub> "x23 <sup>3</sup> / <sub>8</sub> " Matt	33x150 cm 13"x59" Matt	33x75 cm 13"x29 <sup>1</sup> / <sub>2</sub> " Matt	33x60 cm 13"x23 <sup>3</sup> / <sub>8</sub> " Matt	33x33 cm 13"x13" Matt	15x60 H. 4 cm 5 <sup>1</sup> / <sub>8</sub> "x23 <sup>3</sup> / <sub>8</sub> " H. 1 <sup>1</sup> / <sub>8</sub> " Grip
White	AUOT	AUP6	A8N7	AALE	AAK3	AALK	AAQ4
Beige	AUOU	AUP7	A8N8	AALG	AAK4	AALL	AAQ5
Silver	AUOV	AUP8	A8N9	AALH	AAK5	AALM	AAQ6
Pearl	AUOW	AUP9	A8OA	AALI	AAK6	AALN	AAQ7
Grey	AUOX	AUQA	A8OB	AALJ	AAK7	AALO	AAQ8
						DX AUO3	SX AUOY
						AUO4	AUOZ
						AUO5	AUOØ
						AUO6	AUO1
						AUO7	AUO2

\* These parts are supplied to order - I pezzi sono disponibili su ordinazione - Les pièces sont disponibles sur commande - Die Teile sind auf Bestellung lieferbar - Las piezas se hacen por encargo - Изготавливаются на заказ

Matte surface - Superficie matt - Surface Mat - Matte Oberfläche - Superficie Mate - Матовая поверхность  
 Grip surface - Superficie grip - Surface grip - Grip Oberfläche - Superficie Grip - Grip поверхность



INDEX



PRODUCT  
 FINDER



SURFACE  
 RANGE



COMPANY



COLLECTIONS



- 3D WALL
- CONCRETE & RESIN LOOK
- METAL LOOK
- MARBLE LOOK
- STONE LOOK
- WOOD LOOK

LARGE SIZES



TECHNICAL  
 SPECIFICATIONS



# Kone

## Porcelain Tiles

### DECOR RANGE



AUNR Kone White Mosaico  
30x30 - 1<sup>1</sup>/<sub>4</sub>"x1<sup>1</sup>/<sub>4</sub>"



AUNS Kone Beige Mosaico  
30x30 - 1<sup>1</sup>/<sub>4</sub>"x1<sup>1</sup>/<sub>4</sub>"



AUNT Kone Silver Mosaico  
30x30 - 1<sup>1</sup>/<sub>4</sub>"x1<sup>1</sup>/<sub>4</sub>"



AUNU Kone Pearl Mosaico  
30x30 - 1<sup>1</sup>/<sub>4</sub>"x1<sup>1</sup>/<sub>4</sub>"



AUNV Kone Grey Mosaico  
30x30 - 1<sup>1</sup>/<sub>4</sub>"x1<sup>1</sup>/<sub>4</sub>"

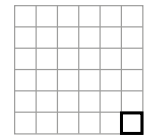

4,8x4,8 cm  
1<sup>1</sup>/<sub>8</sub>"x1<sup>1</sup>/<sub>8</sub>"



AUN9 Kone White Mosaico Pinnacle 3D  
30x30 - 1<sup>1</sup>/<sub>4</sub>"x1<sup>1</sup>/<sub>4</sub>"



AUOA Kone Beige Mosaico Pinnacle 3D  
30x30 - 1<sup>1</sup>/<sub>4</sub>"x1<sup>1</sup>/<sub>4</sub>"



AUOB Kone Silver Mosaico Pinnacle 3D  
30x30 - 1<sup>1</sup>/<sub>4</sub>"x1<sup>1</sup>/<sub>4</sub>"



AUOC Kone Pearl Mosaico Pinnacle 3D  
30x30 - 1<sup>1</sup>/<sub>4</sub>"x1<sup>1</sup>/<sub>4</sub>"



AUOD Kone Grey Mosaico Pinnacle 3D  
30x30 - 1<sup>1</sup>/<sub>4</sub>"x1<sup>1</sup>/<sub>4</sub>"



29,6x2,5 cm  
1<sup>1</sup>/<sub>8</sub>"x1"



AARA Kone Warm Industrial 3D  
31,5x45 - 12<sup>3</sup>/<sub>8</sub>"x17<sup>3</sup>/<sub>8</sub>"



AAQ9 Kone Cold Industrial 3D  
31,5x45 - 12<sup>3</sup>/<sub>8</sub>"x17<sup>3</sup>/<sub>8</sub>"

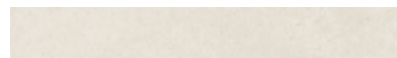

AUNM Kone White Listello  
8x60 - 3<sup>1</sup>/<sub>8</sub>"x23<sup>3</sup>/<sub>8</sub>"

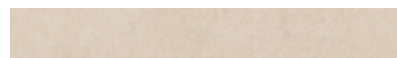

AUNN Kone Beige Listello  
8x60 - 3<sup>1</sup>/<sub>8</sub>"x23<sup>3</sup>/<sub>8</sub>"



AUNO Kone Silver Listello  
8x60 - 3<sup>1</sup>/<sub>8</sub>"x23<sup>3</sup>/<sub>8</sub>"



AUNP Kone Pearl Listello  
8x60 - 3<sup>1</sup>/<sub>8</sub>"x23<sup>3</sup>/<sub>8</sub>"



AUNQ Kone Grey Listello  
8x60 - 3<sup>1</sup>/<sub>8</sub>"x23<sup>3</sup>/<sub>8</sub>"



AUNW Kone White Brick  
30x60 - 1<sup>1</sup>/<sub>4</sub>"x23<sup>3</sup>/<sub>8</sub>"



AUNZ Kone Pearl Brick  
30x60 - 1<sup>1</sup>/<sub>4</sub>"x23<sup>3</sup>/<sub>8</sub>"

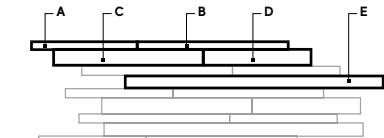

A 2,1x24,8 cm - 3<sup>1</sup>/<sub>2</sub>"x9<sup>7</sup>/<sub>8</sub>"  
B 2,1x34,5 cm - 3<sup>1</sup>/<sub>4</sub>"x13<sup>3</sup>/<sub>8</sub>"  
C 3,3x34,5 cm - 1<sup>1</sup>/<sub>4</sub>"x13<sup>3</sup>/<sub>8</sub>"  
D 3,3x24,8 cm - 1<sup>1</sup>/<sub>4</sub>"x9<sup>7</sup>/<sub>8</sub>"  
E 2,5x60 cm - 1"x23<sup>3</sup>/<sub>8</sub>"



AUNX Kone Beige Brick  
30x60 - 1<sup>1</sup>/<sub>4</sub>"x23<sup>3</sup>/<sub>8</sub>"



AUNØ Kone Grey Brick  
30x60 - 1<sup>1</sup>/<sub>4</sub>"x23<sup>3</sup>/<sub>8</sub>"



AUNY Kone Silver Brick  
30x60 - 1<sup>1</sup>/<sub>4</sub>"x23<sup>3</sup>/<sub>8</sub>"



AUOO Kone White Chevron  
11,5x67 - 4<sup>1</sup>/<sub>2</sub>"x26<sup>3</sup>/<sub>8</sub>"



AUOR Kone Pearl Chevron  
11,5x67 - 4<sup>1</sup>/<sub>2</sub>"x26<sup>3</sup>/<sub>8</sub>"

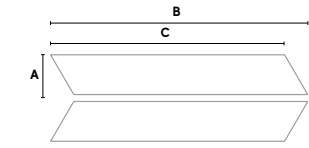

A 11,5 cm - 4<sup>1</sup>/<sub>2</sub>"  
B 73,4 cm - 28<sup>7</sup>/<sub>8</sub>"  
C 67 cm - 26<sup>3</sup>/<sub>8</sub>"



AUOP Kone Beige Chevron  
11,5x67 - 4<sup>1</sup>/<sub>2</sub>"x26<sup>3</sup>/<sub>8</sub>"



AUOS Kone Grey Chevron  
11,5x67 - 4<sup>1</sup>/<sub>2</sub>"x26<sup>3</sup>/<sub>8</sub>"



AUOQ Kone Silver Chevron  
11,5x67 - 4<sup>1</sup>/<sub>2</sub>"x26<sup>3</sup>/<sub>8</sub>"

The decoration can only be laid on the wall - Il decoro si può posare solo a rivestimento - Décor uniquement mural - Das Dekor kann nur an der Wand verlegt werden  
La decoración se puede colocar únicamente en paredes - Декор может быть уложен только на стену.

INDEX



PRODUCT FINDER



SURFACE RANGE



COMPANY



COLLECTIONS



- 3D WALL
- CONCRETE & RESIN LOOK
- METAL LOOK
- MARBLE LOOK
- STONE LOOK
- WOOD LOOK

LARGE SIZES



TECHNICAL SPECIFICATIONS



# Lims

DOWNLOAD >  
CATALOG &  
IMAGE GALLERY

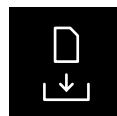

ENJOY THE  
VIDEO

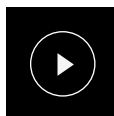

© Ceramiche Atlas Concorde



© Ceramiche Atlas Concorde



© Ceramiche Atlas Concorde

## Porcelain Tiles



### COLOURED BODY PORCELAIN TILES - RECTIFIED MONOCALIBER

Sizes	Thickness	Surface finish
120x278 cm - 47 <sup>1</sup> / <sub>4</sub> "x109 <sup>1</sup> / <sub>2</sub> "	± 6 mm	Matte <b>R9 A</b>
120x120 cm - 47 <sup>1</sup> / <sub>4</sub> "x47 <sup>1</sup> / <sub>4</sub> "	± 9 mm	Matte <b>R10 A+B</b>
75x150 cm - 29 <sup>1</sup> / <sub>2</sub> "x59"	± 9 mm	Matte <b>R10 A+B</b>
75x75 cm - 29 <sup>1</sup> / <sub>2</sub> "x29 <sup>1</sup> / <sub>2</sub> "	± 9 mm	Matte <b>R10 A+B</b>
37,5x75 cm - 14 <sup>3</sup> / <sub>4</sub> "x29 <sup>1</sup> / <sub>2</sub> "	± 9 mm	Matte I Bush Hammered Line I Tumbled <b>R10 A+B</b>

LARGE SIZES p. 390

### OUTDOOR PAVING AND WET AREAS

Sizes	Thickness	Surface finish
37,5x75 cm - 14 <sup>3</sup> / <sub>4</sub> "x29 <sup>1</sup> / <sub>2</sub> "	± 9 mm	Grip <b>R11 A+B+C</b>
60x120 cm - 23 <sup>5</sup> / <sub>8</sub> "x47 <sup>1</sup> / <sub>4</sub> "	± 20 mm	Outdoor <b>R11 A+B+C</b>
60x60 cm - 23 <sup>5</sup> / <sub>8</sub> "x23 <sup>5</sup> / <sub>8</sub> "	± 20 mm	Outdoor <b>R11 A+B+C</b>

## Wall Tiles

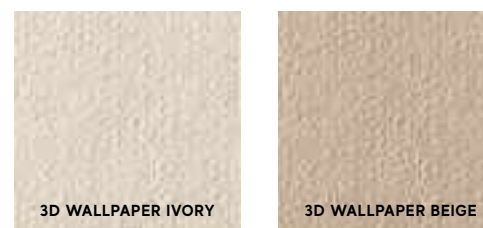
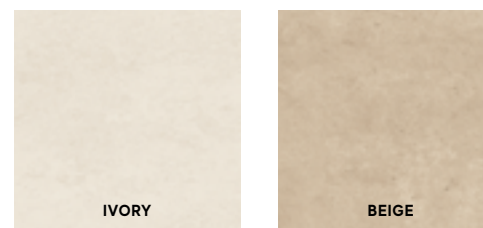

### WHITEBODY WALL TILES - RECTIFIED MONOCALIBER

Sizes	Thickness	Surface finish
40x80 cm - 15 <sup>3</sup> / <sub>4</sub> "x31 <sup>1</sup> / <sub>2</sub> "	± 8,5 mm	Matte
<b>3D WALL TILES</b>		
40x80 cm - 15 <sup>3</sup> / <sub>4</sub> "x31 <sup>1</sup> / <sub>2</sub> "	± 10 mm	Matte

Coloured body porcelain tiles - Gres porcellanato colorato in massa - Grès cérame coloré dans la masse - Durchgefärbtes Feinsteinzeug - Gres porcelánico coloreado en masa - Керамический гранит окрашенный в массу  
 Whitebody wall tiles - Rivestimenti in pasta bianca - Revêtements en pâte blanche - Weißscherbige Wandfliesen - Revestimientos en pasta blanca - Настенная плитка из белой глины  
 Rectified monocaliber - Rettificato monocalibro - Rectifié mono-calibre - Geschliffen einkalibrig - Rectificado monocalibre - Ретифицированный в одном калибре

INDEX



PRODUCT  
FINDER



SURFACE  
RANGE



COMPANY



COLLECTIONS



- 3D WALL
- CONCRETE & RESIN LOOK
- METAL LOOK
- MARBLE LOOK
- STONE LOOK
- WOOD LOOK

LARGE SIZES



TECHNICAL  
SPECIFICATIONS



# Lims

## Porcelain Tiles



Matte ± 6 mm



Matte / Line / Tumbled / Bush Hammered ± 9 mm  
Grip ± 9 mm  
Outdoor ± 20 mm



R9 A Matte ± 6 mm  
R10 A+B Matte / Line / Tumbled / Bush Hammered ± 9 mm  
R11 A+B+C Grip ± 9 mm  
R11 A+B+C Outdoor ± 20 mm



V3 Moderate  
Variation

### MATTE SURFACE

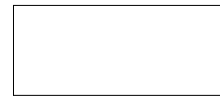

± 6 mm  
120x278 cm - 47<sup>1</sup>/<sub>4</sub>"x109<sup>1</sup>/<sub>2</sub>"  
A3EI Lims Ivory  
A3EJ Lims Beige  
A3EK Lims Grey  
A3EL Lims Desert



± 9 mm  
120x120 cm - 47<sup>1</sup>/<sub>4</sub>"x47<sup>1</sup>/<sub>4</sub>"  
A3DI Lims Ivory  
A3DJ Lims Beige  
A3DK Lims Grey  
A3DL Lims Desert



± 9 mm  
75x150 cm - 29<sup>1</sup>/<sub>2</sub>"x59"  
A7HT Lims Ivory  
A7HU Lims Beige  
A7HV Lims Grey  
A7HW Lims Desert



± 9 mm  
75x75 cm - 29<sup>1</sup>/<sub>2</sub>"x29<sup>1</sup>/<sub>2</sub>"  
A3DQ Lims Ivory  
A3DR Lims Beige  
A3DS Lims Grey  
A3DT Lims Desert



± 9 mm  
37.5x75 cm - 14<sup>3</sup>/<sub>4</sub>"x29<sup>1</sup>/<sub>2</sub>"  
A3DU Lims Ivory  
A3DV Lims Beige  
A3DW Lims Grey  
A3DX Lims Desert



### LINE SURFACE



± 9 mm  
37.5x75 cm - 14<sup>3</sup>/<sub>4</sub>"x29<sup>1</sup>/<sub>2</sub>"  
A3EE Lims Ivory Line  
A3EF Lims Beige Line  
A3EG Lims Grey Line  
A3EH Lims Desert Line



± 9 mm  
37.5x75 cm - 14<sup>3</sup>/<sub>4</sub>"x29<sup>1</sup>/<sub>2</sub>"  
A3EA Lims Ivory Bush Hammered  
A3EB Lims Beige Bush Hammered  
A3EC Lims Grey Bush Hammered  
A3ED Lims Desert Bush Hammered



± 9 mm  
37.5x75 cm - 14<sup>3</sup>/<sub>4</sub>"x29<sup>1</sup>/<sub>2</sub>"  
A3FT Lims Ivory Tumbled  
A3FU Lims Beige Tumbled  
A3FV Lims Grey Tumbled  
A3FW Lims Desert Tumbled



### GRIP SURFACE



± 9 mm  
37.5x75 cm - 14<sup>3</sup>/<sub>4</sub>"x29<sup>1</sup>/<sub>2</sub>"  
A3DY Lims Ivory Grip  
A3DZ Lims Beige Grip  
A3DØ Lims Grey Grip  
A3D1 Lims Desert Grip



### OUTDOOR ± 20 mm



± 20 mm  
60x120 cm - 23<sup>5</sup>/<sub>8</sub>"x47<sup>1</sup>/<sub>4</sub>"  
A3LU Lims Ivory 20 mm  
A3LV Lims Beige 20 mm  
A3LW Lims Grey 20 mm  
A3LX Lims Desert 20 mm



± 20 mm  
60x60 cm - 23<sup>5</sup>/<sub>8</sub>"x23<sup>5</sup>/<sub>8</sub>"  
A3LY Lims Ivory 20 mm  
A3LZ Lims Beige 20 mm  
A3LØ Lims Grey 20 mm  
A3L1 Lims Desert 20 mm



MATTE



IVORY



BEIGE



GREY



DESERT

LINE

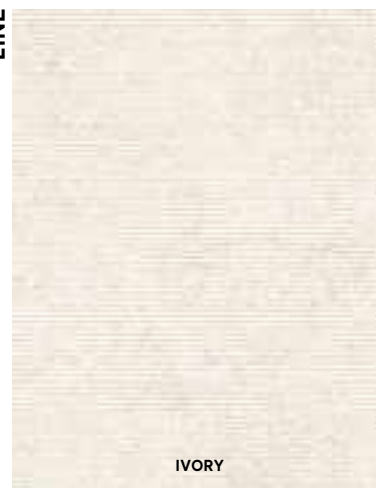

IVORY



BEIGE



GREY



DESERT

BUSH HAMMERED



IVORY



BEIGE



GREY



DESERT

TUMBLLED



IVORY



BEIGE



GREY



DESERT

Matte surface - Superficie matt - Surface Mat - Matte Oberfläche - Superficie Mate - Матовая поверхность  
 Bush hammered surface - Superficie bush hammered - Surface bush hammered - Gehämmerte Oberfläche - Superficie abujardada - Бучардированная поверхность  
 Line surface - Superficie line - Surface Line - Linienoberfläche - Superficie Line - Поверхность Line  
 Tumbled edges - Bordi tumbled - bords Tumbled - Getrommelte Kanten - bordes Tumbled - Галтованная края  
 Grip surface - Superficie grip - Surface grip - Grip Oberfläche - Superficie Grip - Grip поверхность  
 Outdoor - Pavimenti da esterno - Sols d'extérieur - Bodenbeläge für Außenbereiche - Pavimentos para exteriores - Уличная плитка

INDEX



PRODUCT  
FINDER



SURFACE  
RANGE



COMPANY



COLLECTIONS



- 3D WALL
- CONCRETE & RESIN LOOK
- METAL LOOK
- MARBLE LOOK
- STONE LOOK
- WOOD LOOK

LARGE SIZES



TECHNICAL  
SPECIFICATIONS



# Lims

## Porcelain Tiles

### DECOR RANGE



A3JE Lims Ivory  
Mosaico Gemini  
41,6x24 - 16<sup>1</sup>/<sub>8</sub>"x9<sup>1</sup>/<sub>2</sub>"



A3JF Lims Beige  
Mosaico Gemini  
41,6x24 - 16<sup>1</sup>/<sub>8</sub>"x9<sup>1</sup>/<sub>2</sub>"



A3JG Lims Grey  
Mosaico Gemini  
41,6x24 - 16<sup>1</sup>/<sub>8</sub>"x9<sup>1</sup>/<sub>2</sub>"



A3JH Lims Desert  
Mosaico Gemini  
41,6x24 - 16<sup>1</sup>/<sub>8</sub>"x9<sup>1</sup>/<sub>2</sub>"

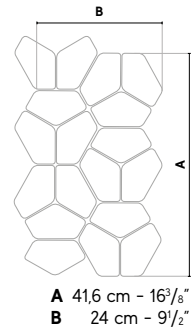

A3NE Lims Ivory  
Mosaico Spritz  
29x32,3 - 11<sup>1</sup>/<sub>8</sub>"x12<sup>3</sup>/<sub>4</sub>"



A3NF Lims Beige  
Mosaico Spritz  
29x32,3 - 11<sup>1</sup>/<sub>8</sub>"x12<sup>3</sup>/<sub>4</sub>"



A3NG Lims Grey  
Mosaico Spritz  
29x32,3 - 11<sup>1</sup>/<sub>8</sub>"x12<sup>3</sup>/<sub>4</sub>"



A3NH Lims Desert  
Mosaico Spritz  
29x32,3 - 11<sup>1</sup>/<sub>8</sub>"x12<sup>3</sup>/<sub>4</sub>"

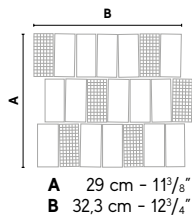

A3HK Lims Ivory  
Mosaico Tumbled ▲  
30x30 - 11<sup>1</sup>/<sub>8</sub>"x11<sup>1</sup>/<sub>8</sub>"



A3HL Lims Beige  
Mosaico Tumbled ▲  
30x30 - 11<sup>1</sup>/<sub>8</sub>"x11<sup>1</sup>/<sub>8</sub>"



A3HM Lims Grey  
Mosaico Tumbled ▲  
30x30 - 11<sup>1</sup>/<sub>8</sub>"x11<sup>1</sup>/<sub>8</sub>"



A3HN Lims Desert  
Mosaico Tumbled ▲  
30x30 - 11<sup>1</sup>/<sub>8</sub>"x11<sup>1</sup>/<sub>8</sub>"

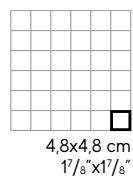

A3JA Lims Ivory Brick  
37,5x75 - 14<sup>3</sup>/<sub>4</sub>"x29<sup>1</sup>/<sub>2</sub>"



A3JB Lims Beige Brick  
37,5x75 - 14<sup>3</sup>/<sub>4</sub>"x29<sup>1</sup>/<sub>2</sub>"

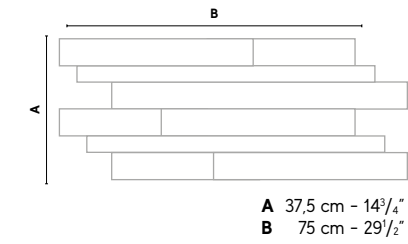

A3JC Lims Grey Brick  
37,5x75 - 14<sup>3</sup>/<sub>4</sub>"x29<sup>1</sup>/<sub>2</sub>"



A3JD Lims Desert Brick  
37,5x75 - 14<sup>3</sup>/<sub>4</sub>"x29<sup>1</sup>/<sub>2</sub>"

INDEX



PRODUCT FINDER



SURFACE RANGE



COMPANY



COLLECTIONS



- 3D WALL
- CONCRETE & RESIN LOOK
- METAL LOOK
- MARBLE LOOK
- STONE LOOK
- WOOD LOOK

LARGE SIZES



TECHNICAL SPECIFICATIONS



▲ Tumbled - Burattato - Tamisé - Genarbt - Tamboreado - Выщербленный

\* These parts are supplied to order - I pezzi sono disponibili su ordinazione - Les pièces sont disponibles sur commande - Die Teile sind auf Bestellung lieferbar - Las piezas se hacen por encargo - Изготавливаются на заказ

# Lims Wall Tiles

## MATTE SURFACE



V2 Slight Variation



± 8,5 mm

40x80 cm - 15<sup>3</sup>/<sub>4</sub>"x31<sup>1</sup>/<sub>2</sub>"

A3HO Lims Ivory

A3HP Lims Beige



± 10 mm 3D WALL

40x80 cm - 15<sup>3</sup>/<sub>4</sub>"x31<sup>1</sup>/<sub>2</sub>"

A3HR Lims 3D Wallpaper Ivory

A3HS Lims 3D Wallpaper Beige

A3HT Lims 3D Way Ivory

A3HU Lims 3D Way Beige

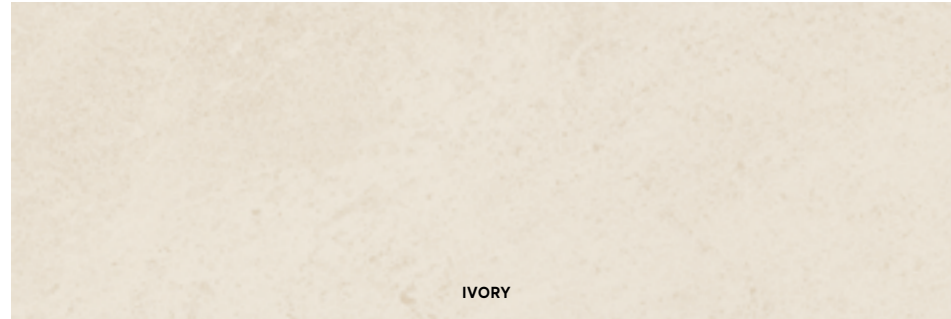

IVORY



BEIGE

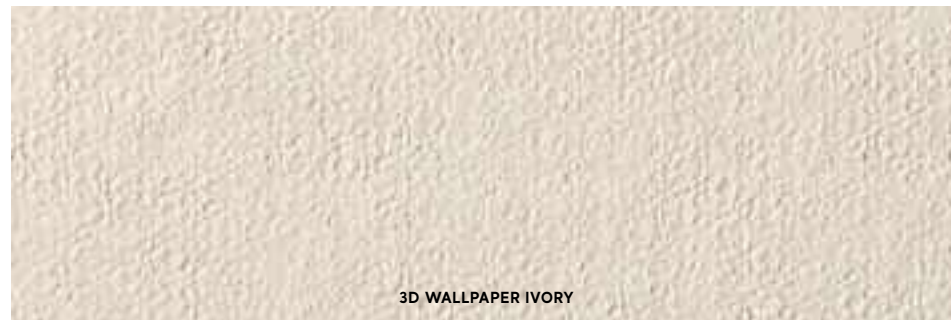

3D WALLPAPER IVORY



3D WALLPAPER BEIGE



3D WAY IVORY



3D WAY BEIGE

## TRIM TILES

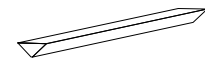

1,4x40 cm - 5<sup>5</sup>/<sub>8</sub>"x15<sup>1</sup>/<sub>4</sub>"

A3HV Lims Ivory Corner 40 \*

A3HW Lims Beige Corner 40 \*



1,4x1,4 cm - 5<sup>5</sup>/<sub>8</sub>"x5<sup>5</sup>/<sub>8</sub>"

A3HZ Lims Ivory Corner A.E. \*

A3HØ Lims Beige Corner A.E. \*



1,4x40 cm - 5<sup>5</sup>/<sub>8</sub>"x15<sup>1</sup>/<sub>4</sub>"

A3HX Lims 3D Wallpaper Ivory Corner 40 \*

A3HY Lims 3D Wallpaper Beige Corner 40 \*

\* These parts are supplied to order - I pezzi sono disponibili su ordinazione - Les pièces sont disponibles sur commande - Die Teile sind auf Bestellung lieferbar - Las piezas se hacen por encargo - Изготавливаются на заказ

Matte surface - superficie matt - Surface Mat - Matte Oberfläche - Superficie Mate - Матовая поверхность



© Ceramiche Atlas Concorde



© Ceramiche Atlas Concorde

INDEX



PRODUCT  
FINDER



SURFACE  
RANGE



COMPANY



COLLECTIONS



- 3D WALL
- CONCRETE & RESIN LOOK
- METAL LOOK
- MARBLE LOOK
- STONE LOOK
- WOOD LOOK

LARGE SIZES



TECHNICAL  
SPECIFICATIONS



# Marvel Stone

DOWNLOAD >  
CATALOG &  
IMAGE GALLERY



ENJOY THE  
VIDEO

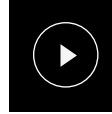

© Ceramiche Atlas Concorde



© Ceramiche Atlas Concorde



© Ceramiche Atlas Concorde

## Porcelain Tiles



### COLOURED BODY PORCELAIN TILES - RECTIFIED MONOCALIBER

Sizes	Thickness	Surface finish
162x324 cm - 63 <sup>3</sup> / <sub>4</sub> "x127 <sup>1</sup> / <sub>2</sub> " NON RECTIFIED	± 6-12-20 mm	Hammered
120x240 cm - 47 <sup>1</sup> / <sub>4</sub> "x94 <sup>1</sup> / <sub>2</sub> "	± 9 mm	Matte R9 A
120x120 cm - 47 <sup>1</sup> / <sub>4</sub> "x47 <sup>1</sup> / <sub>4</sub> "	± 9 mm	Matte R9 A
75x150 cm - 29 <sup>1</sup> / <sub>2</sub> "x59"	± 9 mm	Matte R9 A
75x75 cm - 29 <sup>1</sup> / <sub>2</sub> "x29 <sup>1</sup> / <sub>2</sub> "	± 9 mm	Matte R9 A
45x90 cm - 17 <sup>3</sup> / <sub>8</sub> "x35 <sup>5</sup> / <sub>8</sub> "	± 9 mm	Matte R9 A
60x60 cm - 23 <sup>5</sup> / <sub>8</sub> "x23 <sup>5</sup> / <sub>8</sub> "	± 9 mm	Matte R9 A
30x60 cm - 11 <sup>1</sup> / <sub>4</sub> "x23 <sup>5</sup> / <sub>8</sub> "	± 9 mm	Matte R9 A

LARGE SIZES p. 390

### OUTDOOR PAVING AND WET AREAS

Sizes	Thickness	Surface finish
30x60 cm - 11 <sup>1</sup> / <sub>4</sub> "x23 <sup>5</sup> / <sub>8</sub> "	± 9 mm	Textured R11 A+B+C
60x120 cm - 23 <sup>5</sup> / <sub>8</sub> "x47 <sup>1</sup> / <sub>4</sub> "	± 20 mm	Outdoor R11 A+B+C

MARVEL STONE COLLECTION MARBLE LOOK p. 266

INDEX



PRODUCT  
FINDER



SURFACE  
RANGE



COMPANY



COLLECTIONS



- 3D WALL
- CONCRETE & RESIN LOOK
- METAL LOOK
- MARBLE LOOK
- STONE LOOK
- WOOD LOOK

LARGE SIZES



TECHNICAL  
SPECIFICATIONS



Coloured body porcelain tiles - Gres porcellanato colorato in massa - Grès cérame coloré dans la masse - Durchgefärbtes Feinsteinzeug - Gres porcelánico coloreado en masa - Керамический гранит окрашенный в массу  
 Rectified monocaliber - Rettificato monocalibro - Rectifié mono-calibre - Geschliffen einkalbrig - Rectificado monocalibre - Ретифицированный в одном калибре  
 Non rectified - Non rettificato - Non rectifié - Nicht rektifiziert - No rectificada - Неретифицированные





# Marvel Stone

## Porcelain Tiles

### DECOR RANGE



AS4J Marvel Clauzetto White Mosaico Bacchetta 30x30 - 1<sup>1</sup>/<sub>4</sub>"x1<sup>1</sup>/<sub>4</sub>"  
 AS4I Marvel Desert Beige Mosaico Bacchetta 30x30 - 1<sup>1</sup>/<sub>4</sub>"x1<sup>1</sup>/<sub>4</sub>"  
 AS4H Marvel Cardoso Elegant Mosaico Bacchetta 30x30 - 1<sup>1</sup>/<sub>4</sub>"x1<sup>1</sup>/<sub>4</sub>"  
 AS4G Marvel Basaltina Volcano Mosaico Bacchetta 30x30 - 1<sup>1</sup>/<sub>4</sub>"x1<sup>1</sup>/<sub>4</sub>"

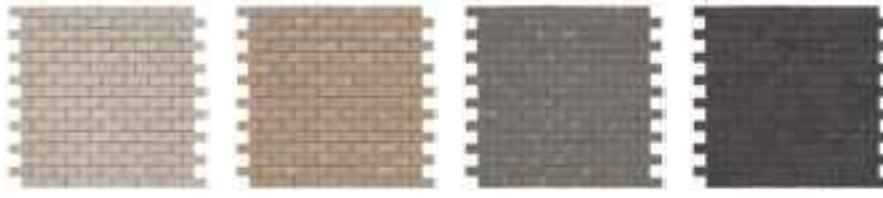

AS4N Marvel Clauzetto White Mosaico Burattato 29,8x29,8 - 1<sup>1</sup>/<sub>8</sub>"x1<sup>1</sup>/<sub>8</sub>"  
 AS4M Marvel Desert Beige Mosaico Burattato 29,8x29,8 - 1<sup>1</sup>/<sub>8</sub>"x1<sup>1</sup>/<sub>8</sub>"  
 AS4L Marvel Cardoso Elegant Mosaico Burattato 29,8x29,8 - 1<sup>1</sup>/<sub>8</sub>"x1<sup>1</sup>/<sub>8</sub>"  
 AS4K Marvel Basaltina Volcano Mosaico Burattato 29,8x29,8 - 1<sup>1</sup>/<sub>8</sub>"x1<sup>1</sup>/<sub>8</sub>"



AS4F Marvel Clauzetto White Mosaico 30x30 - 1<sup>1</sup>/<sub>4</sub>"x1<sup>1</sup>/<sub>4</sub>"  
 AS4E Marvel Desert Beige Mosaico 30x30 - 1<sup>1</sup>/<sub>4</sub>"x1<sup>1</sup>/<sub>4</sub>"  
 AS4D Marvel Cardoso Elegant Mosaico 30x30 - 1<sup>1</sup>/<sub>4</sub>"x1<sup>1</sup>/<sub>4</sub>"  
 AS4C Marvel Basaltina Volcano Mosaico 30x30 - 1<sup>1</sup>/<sub>4</sub>"x1<sup>1</sup>/<sub>4</sub>"



AS46 Marvel Clauzetto White Listello 7x60 - 2<sup>1</sup>/<sub>4</sub>"x23<sup>3</sup>/<sub>8</sub>"  
 AS45 Marvel Desert Beige Listello 7x60 - 2<sup>1</sup>/<sub>4</sub>"x23<sup>3</sup>/<sub>8</sub>"



AS44 Marvel Cardoso Elegant Listello 7x60 - 2<sup>1</sup>/<sub>4</sub>"x23<sup>3</sup>/<sub>8</sub>"  
 AS43 Marvel Basaltina Volcano Listello 7x60 - 2<sup>1</sup>/<sub>4</sub>"x23<sup>3</sup>/<sub>8</sub>"

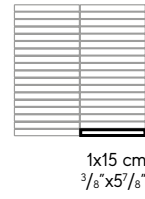

1x15 cm  
3/8"x5/8"

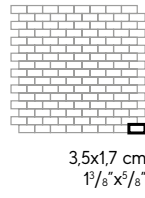

3,5x1,7 cm  
1/8"x2/8"

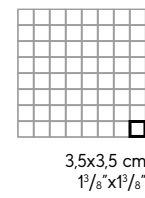

3,5x3,5 cm  
1/4"x1/4"



AS4S Marvel Clauzetto White Brick 30x60 - 1<sup>1</sup>/<sub>4</sub>"x23<sup>3</sup>/<sub>8</sub>"



AS4Q Marvel Desert Beige Brick 30x60 - 1<sup>1</sup>/<sub>4</sub>"x23<sup>3</sup>/<sub>8</sub>"



AS4P Marvel Cardoso Elegant Brick 30x60 - 1<sup>1</sup>/<sub>4</sub>"x23<sup>3</sup>/<sub>8</sub>"



AS4O Marvel Basaltina Volcano Brick 30x60 - 1<sup>1</sup>/<sub>4</sub>"x23<sup>3</sup>/<sub>8</sub>"



AS5A Marvel Clauzetto White Brick 3D 30x59 - 1<sup>1</sup>/<sub>4</sub>"x23<sup>3</sup>/<sub>4</sub>"



AS49 Marvel Desert Beige Brick 3D 30x59 - 1<sup>1</sup>/<sub>4</sub>"x23<sup>3</sup>/<sub>4</sub>"



AS48 Marvel Cardoso Elegant Brick 3D 30x59 - 1<sup>1</sup>/<sub>4</sub>"x23<sup>3</sup>/<sub>4</sub>"



AS47 Marvel Basaltina Volcano Brick 3D 30x59 - 1<sup>1</sup>/<sub>4</sub>"x23<sup>3</sup>/<sub>4</sub>"

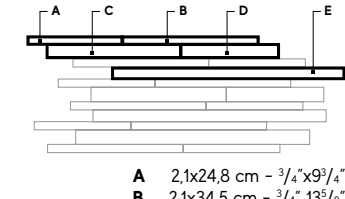

A 2,1x24,8 cm - 3/4"x9<sup>3</sup>/<sub>4</sub>"  
 B 2,1x34,5 cm - 3/4"x13<sup>3</sup>/<sub>8</sub>"  
 C 3,3x34,5 cm - 1<sup>1</sup>/<sub>4</sub>"x13<sup>3</sup>/<sub>8</sub>"  
 D 3,3x24,8 cm - 1<sup>1</sup>/<sub>4</sub>"x9<sup>3</sup>/<sub>4</sub>"  
 E 2,5x60 cm - 1"x23<sup>3</sup>/<sub>8</sub>"

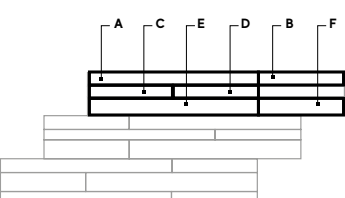

A 3,1x39,5 cm - 1<sup>1</sup>/<sub>4</sub>"x15<sup>1</sup>/<sub>2</sub>"  
 B 3,1x19,5 cm - 1<sup>1</sup>/<sub>4</sub>"x7<sup>7</sup>/<sub>8</sub>"  
 C 2,3x19,5 cm - 7/8"x7<sup>7</sup>/<sub>8</sub>"  
 D 2,3x39,5 cm - 7/8"x15<sup>1</sup>/<sub>2</sub>"  
 E 4,5x39,5 cm - 1<sup>3</sup>/<sub>4</sub>"x15<sup>1</sup>/<sub>2</sub>"  
 F 4,5x19,5 cm - 1<sup>3</sup>/<sub>4</sub>"x7<sup>7</sup>/<sub>8</sub>"

INDEX



PRODUCT FINDER



SURFACE RANGE



COMPANY



COLLECTIONS



- 3D WALL
- CONCRETE & RESIN LOOK
- METAL LOOK
- MARBLE LOOK
- STONE LOOK
- WOOD LOOK

LARGE SIZES



TECHNICAL SPECIFICATIONS



The decoration can only be laid on the wall - Il decoro si può posare solo a rivestimento - Décor uniquement mural - Das Dekor kann nur an der Wand verlegt werden  
 La decoración se puede colocar únicamente en paredes - Декор может быть уложен только на стену.

# Norde

DOWNLOAD >  
CATALOG &  
IMAGE GALLERY

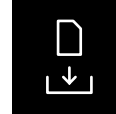

ENJOY THE  
VIDEO

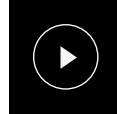

© Ceramiche Atlas Concorde



© Ceramiche Atlas Concorde



© Ceramiche Atlas Concorde

## Porcelain Tiles

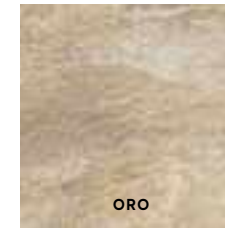

### COLOURED BODY PORCELAIN TILES - RECTIFIED MONOCALIBER

Sizes	Thickness	Surface finish
60x120 cm - 23 <sup>5</sup> / <sub>8</sub> "x47 <sup>1</sup> / <sub>4</sub> "	± 9 mm	Matte R10 A+B
60x60 cm - 23 <sup>5</sup> / <sub>8</sub> "x23 <sup>5</sup> / <sub>8</sub> "	± 9 mm	Matte R10 A+B
30x60 cm - 11 <sup>3</sup> / <sub>4</sub> "x23 <sup>5</sup> / <sub>8</sub> "	± 9 mm	Matte R10 A+B

### OUTDOOR PAVING AND WET AREAS

Sizes	Thickness	Surface finish
30x60 cm - 11 <sup>3</sup> / <sub>4</sub> "x23 <sup>5</sup> / <sub>8</sub> "	± 9 mm	Roccia R12 A+B+C
60x120 cm - 23 <sup>5</sup> / <sub>8</sub> "x47 <sup>1</sup> / <sub>4</sub> "	± 9 mm	Grip R11 A+B+C
60x120 cm - 23 <sup>5</sup> / <sub>8</sub> "x47 <sup>1</sup> / <sub>4</sub> "	± 20 mm	Outdoor R11 A+B+C
60x90 cm - 23 <sup>5</sup> / <sub>8</sub> "x35 <sup>5</sup> / <sub>8</sub> "	± 20 mm	Outdoor R11 A+B+C
60x60 cm - 23 <sup>5</sup> / <sub>8</sub> "x23 <sup>5</sup> / <sub>8</sub> "	± 20 mm	Outdoor R11 A+B+C
80x80 cm - 31 <sup>1</sup> / <sub>2</sub> "x31 <sup>1</sup> / <sub>2</sub> "	± 20 mm	Outdoor R11 A+B+C

INDEX



PRODUCT  
FINDER



SURFACE  
RANGE



COMPANY



COLLECTIONS



- 3D WALL
- CONCRETE & RESIN LOOK
- METAL LOOK
- MARBLE LOOK
- STONE LOOK
- WOOD LOOK

LARGE SIZES



TECHNICAL  
SPECIFICATIONS



Coloured body porcelain tiles - Gres porcellanato colorato in massa - Grès cérame coloré dans la masse - Durchgefärbtes Feinsteinzeug - Gres porcelánico coloreado en masa - Керамический гранит окрашенный в массе  
Rectified monocaliber - Rettificato monocalibro - Rectifié mono-calibre - Geschliffen einkalbrig - Rectificado monocalibre - Ретифицированный в одном калибре



# Norde

## Porcelain Tiles

### DECOR RANGE



A59P Norde Magnesio Brick  
30x60 - 11<sup>1</sup>/<sub>4</sub>"x23<sup>3</sup>/<sub>8</sub>"



A59Q Norde Oro Brick  
30x60 - 11<sup>1</sup>/<sub>4</sub>"x23<sup>3</sup>/<sub>8</sub>"

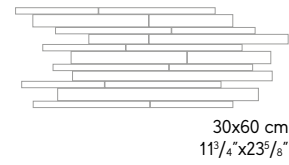

A59R Norde Platino Brick  
30x60 - 11<sup>1</sup>/<sub>4</sub>"x23<sup>3</sup>/<sub>8</sub>"



A59S Norde Piombo Brick  
30x60 - 11<sup>1</sup>/<sub>4</sub>"x23<sup>3</sup>/<sub>8</sub>"



A596 Norde Magnesio  
Brick Corten  
39x27,8 - 15<sup>3</sup>/<sub>8</sub>"x11"



A597 Norde Oro  
Brick Corten  
39x27,8 - 15<sup>3</sup>/<sub>8</sub>"x11"



A598 Norde Platino  
Brick Corten  
39x27,8 - 15<sup>3</sup>/<sub>8</sub>"x11"



A599 Norde Piombo  
Brick Corten  
39x27,8 - 15<sup>3</sup>/<sub>8</sub>"x11"

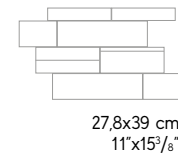

A59L Norde Magnesio  
Mosaico  
30x30 - 11<sup>1</sup>/<sub>4</sub>"x11<sup>1</sup>/<sub>4</sub>"

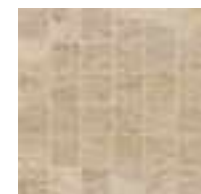

A59M Norde Oro  
Mosaico  
30x30 - 11<sup>1</sup>/<sub>4</sub>"x11<sup>1</sup>/<sub>4</sub>"



A59N Norde Platino  
Mosaico  
30x30 - 11<sup>1</sup>/<sub>4</sub>"x11<sup>1</sup>/<sub>4</sub>"



A59O Norde Piombo  
Mosaico  
30x30 - 11<sup>1</sup>/<sub>4</sub>"x11<sup>1</sup>/<sub>4</sub>"

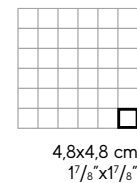

A58U Norde Magnesio  
Composizione Palladiana Grip ▲◆



A58V Norde Oro  
Composizione Palladiana Grip ▲◆



A58W Norde Platino  
Composizione Palladiana Grip ▲◆



A58X Norde Piombo  
Composizione Palladiana Grip ▲◆

■ **Blaze Corten Lappato tessera inserted randomly in four of the six sheets contained in each box.** - Tessera Blaze Corten Lappato inserita in modo casuale in quattro dei sei fogli contenuti in ogni scatola. - Tesselles Blaze Corten Lappato posées de manière aléatoire sur quatre des six feuilles contenues dans chaque boîte. - Die Blaze Corten Lappato Steine werden nach dem Zufallsprinzip auf vier der sechs in jedem Karton enthaltenen Folien verklebt. - Mosaico Blaze Corten Lappato insertado al azar en cuatro de las seis hojas que contiene cada caja. - Чип Blaze Corten Lappato вложен случайным образом в четыре из шести матриц, содержащихся в каждой коробке.

▲ **Minimum order: 8 m<sup>2</sup>. Variable tessera size and shape with tumbled edge. We recommend installation with a joint of no less than 10 mm.** - Ordine minimo di 8 mq. Dimensione e forma delle tessere variabile con bordo burattato. Si consiglia posa con fuga non inferiore a 10mm. - Comande minimum: 8 mètres carrés. Dimensions et forme des tesselles variables avec bord tamisé. Pose conseillée avec un joint non inférieur à 10mm. - Mindestbestellmenge 8 qm. Abmessung und Form der Steine sind unterschiedlich, aber alle weisen getrommelte Kanten auf. Für die Verlegung wird eine Fugenbreite von nicht weniger als 10 mm empfohlen. - Pedido mínimo de 8 m<sup>2</sup>. Tamaño y forma variable de los mosaicos con borde bruñido. Se recomienda colocación con junta de no menos de 10 mm. - Минимальный объем заказа - 8 кв.м. Размер и форма чипа варьируются, чипы имеют выщерблинные края. Рекомендуется укладка с межплиточным швом не менее 10 мм.

◆ **Example of layout measuring about 1 m<sup>2</sup>.** - Esempio di posato corrispondente a circa 1 mq. - Exemple de produit posé correspondant à 1 mètre carré environ. - Verlegebeispiel für circa 1 qm. - Ejemplo de colocación correspondiente aproximadamente a 1 m<sup>2</sup>. - Пример укладки, соответствующий примерно 1 кв.м.

INDEX



PRODUCT  
FINDER



SURFACE  
RANGE



COMPANY



COLLECTIONS



- 3D WALL
- CONCRETE & RESIN LOOK
- METAL LOOK
- MARBLE LOOK
- STONE LOOK
- WOOD LOOK

LARGE SIZES



TECHNICAL  
SPECIFICATIONS



# Norde

## Porcelain Tiles

### DECOR RANGE

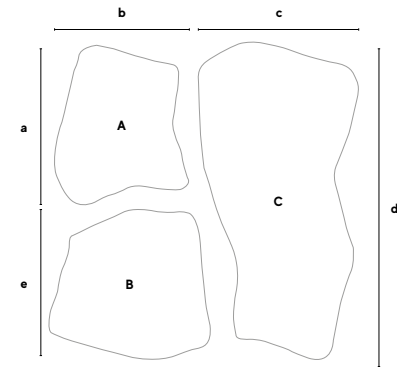

- a 53,7 cm - 21<sup>1</sup>/<sub>8</sub>"
- b 40,1 cm - 15<sup>7</sup>/<sub>8</sub>"
- c 45 cm - 17<sup>3</sup>/<sub>4</sub>"
- d 105 cm - 41<sup>1</sup>/<sub>8</sub>"
- e 39,6 cm - 15<sup>5</sup>/<sub>8</sub>"
- f 55,6 cm - 21<sup>7</sup>/<sub>8</sub>"

A58M Norde Magnesio Path A+B 20 mm ▲  
54x54 - 21<sup>1</sup>/<sub>4</sub>"x21<sup>1</sup>/<sub>4</sub>"

A58N Norde Oro Path A+B 20mm ▲  
54x54 - 21<sup>1</sup>/<sub>4</sub>"x21<sup>1</sup>/<sub>4</sub>"

A58Q Norde Magnesio Path C 20 mm ▲  
55x109 - 21<sup>1</sup>/<sub>8</sub>"x42<sup>7</sup>/<sub>8</sub>"

A58R Norde Oro Path C 20mm ▲  
55x109 - 21<sup>1</sup>/<sub>8</sub>"x42<sup>7</sup>/<sub>8</sub>"



A58O Norde Platino Path A+B 20 mm ▲  
54x54 - 21<sup>1</sup>/<sub>4</sub>"x21<sup>1</sup>/<sub>4</sub>"

A58P Norde Piombo Path A+B 20mm ▲  
54x54 - 21<sup>1</sup>/<sub>4</sub>"x21<sup>1</sup>/<sub>4</sub>"

A58S Norde Platino Path C 20 mm ▲  
55x109 - 21<sup>1</sup>/<sub>8</sub>"x42<sup>7</sup>/<sub>8</sub>"

A58T Norde Piombo Path C 20mm ▲  
55x109 - 21<sup>1</sup>/<sub>8</sub>"x42<sup>7</sup>/<sub>8</sub>"

▲ We recommend 'dry' installation on gravel and/or grass. - Si consiglia posa "a secco" su ghiaia e/o erba. - Pose « à sec » sur gravillons et/ou herbe conseillée. - Es wird eine Trockenverlegung auf Kies bzw. Rasen empfohlen.  
Se recomienda colocación «en seco» sobre grava o hierba. - Рекомендуются «сухая» укладка на гравий и/или траву.



© Ceramiche Atlas Concorde



© Ceramiche Atlas Concorde

INDEX



PRODUCT  
FINDER



SURFACE  
RANGE



COMPANY



COLLECTIONS



- 3D WALL
- CONCRETE & RESIN LOOK
- METAL LOOK
- MARBLE LOOK
- STONE LOOK
- WOOD LOOK

LARGE SIZES



TECHNICAL  
SPECIFICATIONS



# Trust

DOWNLOAD >  
CATALOG &  
IMAGE GALLERY



© Ceramiche Atlas Concorde



© Ceramiche Atlas Concorde



© Ceramiche Atlas Concorde

## Porcelain Tiles



### COLOURED BODY PORCELAIN TILES - RECTIFIED MONOCALIBER

Sizes	Thickness	Surface finish
45x90 cm - 17 <sup>3</sup> / <sub>4</sub> "x35 <sup>3</sup> / <sub>8</sub> "	± 9 mm	Matte R10 A+B
60x60 cm - 23 <sup>3</sup> / <sub>8</sub> "x23 <sup>3</sup> / <sub>8</sub> "	± 9 mm	Matte R10 A+B
30x60 cm - 11 <sup>3</sup> / <sub>4</sub> "x23 <sup>3</sup> / <sub>8</sub> "	± 9 mm	Matte R10 A+B

### OUTDOOR PAVING AND WET AREAS

Sizes	Thickness	Surface finish
30x60 cm - 11 <sup>3</sup> / <sub>4</sub> "x23 <sup>3</sup> / <sub>8</sub> "	± 9 mm	Grip R12 A+B+C
60x120 cm - 23 <sup>3</sup> / <sub>8</sub> "x47 <sup>7</sup> / <sub>8</sub> "	± 20 mm	Outdoor R11 A+B+C
60x60 cm - 23 <sup>3</sup> / <sub>8</sub> "x23 <sup>3</sup> / <sub>8</sub> "	± 30 mm	Outdoor R11 A+B+C
60x60 cm - 23 <sup>3</sup> / <sub>8</sub> "x23 <sup>3</sup> / <sub>8</sub> "	± 20 mm	Outdoor R11 A+B+C
45x90 cm - 17 <sup>3</sup> / <sub>4</sub> "x35 <sup>3</sup> / <sub>8</sub> "	± 20 mm	Outdoor R11 A+B+C

INDEX



PRODUCT  
FINDER



SURFACE  
RANGE



COMPANY



COLLECTIONS



- 3D WALL
- CONCRETE & RESIN LOOK
- METAL LOOK
- MARBLE LOOK
- STONE LOOK
- WOOD LOOK

LARGE SIZES



TECHNICAL  
SPECIFICATIONS





Coloured body porcelain tiles - Gres porcellanato colorato in massa - Grès cérame coloré dans la masse - Durchgefärbtes Feinsteinzeug - Gres porcelánico coloreado en masa - Керамический гранит окрашенный в массе  
Rectified monocaliber - Rettificato monocalibro - Rectifié mono-calibre - Geschliffen einkalbrig - Rectificado monocallibre - Ретифицированный в одном калибре

# Trust

## Porcelain Tiles





### MATTE SURFACE

 <b>± 9 mm</b> <b>60x60 cm</b> - 23 <sup>5</sup> / <sub>8</sub> "x23 <sup>5</sup> / <sub>8</sub> " AA8C Trust Moon Matt ACI1 Trust Ivory Matt ACI3 Trust Gold Matt ACI4 Trust Silver Matt ACI5 Trust Copper Matt ACI6 Trust Titanium Matt	 <b>± 9 mm</b> <b>30x60 cm</b> - 11 <sup>1</sup> / <sub>4</sub> "x23 <sup>5</sup> / <sub>8</sub> " D234 Trust Moon Matt D156 Trust Ivory Matt D157 Trust Gold Matt D158 Trust Silver Matt D159 Trust Copper Matt D160 Trust Titanium Matt	 <b>± 9 mm</b> <b>45x90 cm</b> - 17 <sup>3</sup> / <sub>4</sub> "x35 <sup>3</sup> / <sub>8</sub> " AA8A Trust Moon Matt AKA6 Trust Ivory Matt AKA7 Trust Gold Matt AKA8 Trust Silver Matt AKA9 Trust Copper Matt AKBA Trust Titanium Matt
--	--	--

### GRIP SURFACE

 <b>± 9 mm</b> <b>30x60 cm</b> - 11 <sup>3</sup> / <sub>4</sub> "x23 <sup>5</sup> / <sub>8</sub> " D235 Trust Moon Grip D161 Trust Ivory Grip D162 Trust Gold Grip D163 Trust Silver Grip D164 Trust Copper Grip D165 Trust Titanium Grip
--

### OUTDOOR ± 20 mm

 <b>± 20 mm</b> <b>60x120 cm</b> - 23 <sup>5</sup> / <sub>8</sub> "x47 <sup>1</sup> / <sub>4</sub> " AY4E Trust Gold 20 mm AY4D Trust Silver 20 mm AY4F Trust Titanium 20 mm AY4G Trust Ivory 20 mm	 <b>± 20 mm</b> <b>60x60 cm</b> - 23 <sup>5</sup> / <sub>8</sub> "x23 <sup>5</sup> / <sub>8</sub> " ABLI Trust Gold 20 mm ABLJ Trust Silver 20 mm ABLK Trust Titanium 20 mm AY4B Trust Ivory 20 mm	 <b>± 30 mm</b> <b>60x60 cm</b> - 23 <sup>5</sup> / <sub>8</sub> "x23 <sup>5</sup> / <sub>8</sub> " AL7G Trust Gold 30 mm AL7H Trust Silver 30 mm AL7I Trust Titanium 30 mm	 <b>± 20 mm</b> <b>45x90 cm</b> - 17 <sup>3</sup> / <sub>4</sub> "x35 <sup>3</sup> / <sub>8</sub> " ACHH Trust Gold 20 mm ACHG Trust Silver 20 mm ACHJ Trust Titanium 20 mm AY4C Trust Ivory 20 mm
--	---	---	---

**H** Matte ± 9 mm  
 Grip ± 9 mm  
 Outdoor ± 20 mm  
 Outdoor ± 30 mm  
**HEAVY TRAFFIC**

**R10 A+B** Matte ± 9 mm  
**R12 A+B+C** Grip ± 9 mm  
**R11 A+B+C** Outdoor ± 20 mm  
**R11 A+B+C** Outdoor ± 30 mm

V2 Slight Variation \*  
 V3 Moderate Variation \*\*



### TRIM TILES

p. 462

**UPEC**  
 p. 455



#### Battiscopa

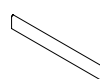

7,5x30 cm  
 3"x11/4"

Matt

#### Gradino \*

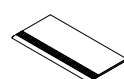

30x30 cm  
 11/4"x11/4"

Matt

#### Scalino \*

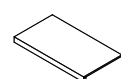

33x33 cm  
 13"x13"

Matt

#### Scalin Ang.\*

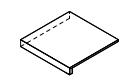

33x33 cm  
 13"x13"

Matt

#### Battiscopa Sag. Scala \*



7,5x30 cm  
 3"x11/4"

Matt

DX SX

#### Elemento L \*

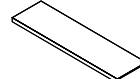

15x60 H. 4 cm  
 5/8"x23/8" H. 1/4"

Grip

\* These parts are supplied to order - I pezzi sono disponibili su ordinazione - Les pièces sont disponibles sur commande - Die Teile sind auf Bestellung lieferbar - Las piezas se hacen por encargo - Изготавливаются на заказ

\* Moon

\*\* Ivory, Gold, Silver, Copper, Titanium

**Matte surface** - Superficie matt - Surface Mat - Matte Oberfläche - Superficie Mate - Матовая поверхность

**Grip surface** - Superficie grip - Surface grip - Grip Oberfläche - Superficie Grip - Grip поверхность

**Outdoor** - Pavimenti da esterno - Sols d'extérieur - Bodenbeläge für Außenbereiche - Pavimentos para exteriores - Уличная плитка

MATTE / GRIP



OUTDOOR 20 mm



INDEX



PRODUCT FINDER



SURFACE RANGE



COMPANY



COLLECTIONS



3D WALL  
 CONCRETE & RESIN LOOK  
 METAL LOOK  
 MARBLE LOOK

STONE LOOK

WOOD LOOK

LARGE SIZES



TECHNICAL SPECIFICATIONS





# Trust

## Porcelain Tiles

### DECOR RANGE



ABDW Trust Moon Mosaico  
30x30 - 1 1/4"x1 1/4"

ACLA Trust Ivory Mosaico  
30x30 - 1 1/4"x1 1/4"

ACLC Trust Gold Mosaico  
30x30 - 1 1/4"x1 1/4"



ACLD Trust Silver Mosaico  
30x30 - 1 1/4"x1 1/4"

ACLE Trust Copper Mosaico  
30x30 - 1 1/4"x1 1/4"

ACLF Trust Titanium Mosaico  
30x30 - 1 1/4"x1 1/4"

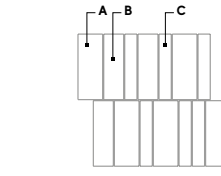

A 5,6x14,7 cm - 2 1/4"x5 7/8"  
B 4,5x14,7 cm - 1 3/4"x5 7/8"  
C 2,8x14,7 cm - 1 1/8"x5 7/8"



ABDX Trust Moon Brick  
30x60 - 1 1/4"x23 3/8"



ACNA Trust Ivory Brick  
30x60 - 1 1/4"x23 3/8"



ACNB Trust Gold Brick  
30x60 - 1 1/4"x23 3/8"



ACNC Trust Silver Brick  
30x60 - 1 1/4"x23 3/8"



ACND Trust Copper Brick  
30x60 - 1 1/4"x23 3/8"



ACNE Trust Titanium Brick  
30x60 - 1 1/4"x23 3/8"

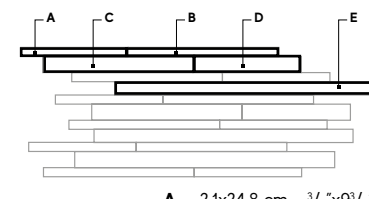

A 2,1x24,8 cm - 3/4"x9 7/8"  
B 2,1x34,5 cm - 3/4"x13 3/8"  
C 3,3x34,5 cm - 1 1/4"x13 3/8"  
D 3,3x24,8 cm - 1 1/4"x9 7/8"  
E 2,5x60 cm - 1"x23 3/8"



INDEX



PRODUCT FINDER



SURFACE RANGE



COMPANY



COLLECTIONS



- 3D WALL
- CONCRETE & RESIN LOOK
- METAL LOOK
- MARBLE LOOK
- STONE LOOK
- WOOD LOOK

LARGE SIZES



TECHNICAL SPECIFICATIONS



# Axi

DOWNLOAD >  
CATALOG &  
IMAGE GALLERY

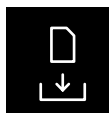

© Ceramiche Atlas Concorde



© Ceramiche Atlas Concorde



© Ceramiche Atlas Concorde

## Porcelain Tiles



WHITE PINE



SILVER FIR

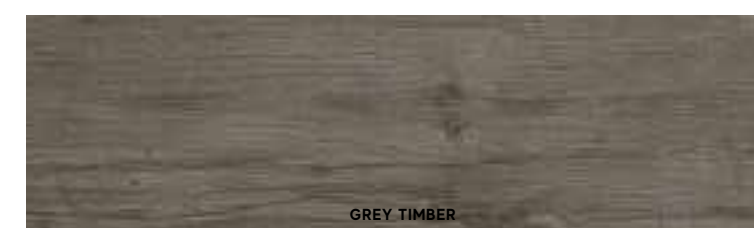

GREY TIMBER



GOLDEN OAK

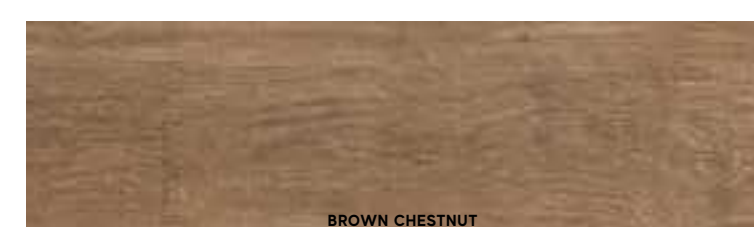

BROWN CHESTNUT



DARK OAK

### COLOURED BODY PORCELAIN TILES - RECTIFIED MONOCALIBER

Sizes	Thickness	Surface finish
22,5x90 cm - 8 <sup>7</sup> / <sub>8</sub> "x35 <sup>3</sup> / <sub>8</sub> "	± 9,5 mm	Matte R10 A+B

### OUTDOOR PAVING AND WET AREAS

Sizes	Thickness	Surface finish
22,5x90 cm - 8 <sup>7</sup> / <sub>8</sub> "x35 <sup>3</sup> / <sub>8</sub> "	± 9,5 mm	Textured R11 A+B+C
45x90 cm - 17 <sup>7</sup> / <sub>8</sub> "x35 <sup>3</sup> / <sub>8</sub> "	± 20 mm	Outdoor R11 A+B+C

Coloured body porcelain tiles - Gres porcellanato colorato in massa - Grès cérame coloré dans la masse - Durchgefärbtes Feinsteinzeug - Gres porcelánico coloreado en masa - Керамический гранит окрашенный в массе  
 Rectified monocaliber - Rettificato monocalibro - Rectifié mono-calibre - Geschliffen einkalbrig - Rectificado monocallibre - Ретифицированный в одном калибре

INDEX



PRODUCT  
FINDER



SURFACE  
RANGE



COMPANY



COLLECTIONS



- 3D WALL
- CONCRETE & RESIN LOOK
- METAL LOOK
- MARBLE LOOK
- STONE LOOK
- WOOD LOOK

LARGE SIZES



TECHNICAL  
SPECIFICATIONS



# Axi

## Porcelain Tiles

**H** HEAVY TRAFFIC  
Matte ± 9.5 mm  
Textured ± 9.5 mm  
Outdoor ± 20 mm

**R10 A+B** Matte ± 9.5 mm  
**R11 A+B+C** Textured ± 9.5 mm  
**R11 A+B+C** Outdoor ± 20 mm

V2 Slight Variation \*  
V3 Moderate Variation \*\*

### MATTE SURFACE



± 9.5 mm  
**22,5x90 cm** - 8<sup>7</sup>/<sub>8</sub>"x35<sup>3</sup>/<sub>8</sub>"  
AS3B Axi White Pine  
AS3D Axi Silver Fir  
AS3E Axi Grey Timber  
AS3C Axi Golden Oak  
AS3A Axi Brown Chestnut  
AS3F Axi Dark Oak

### TEXTURED SURFACE

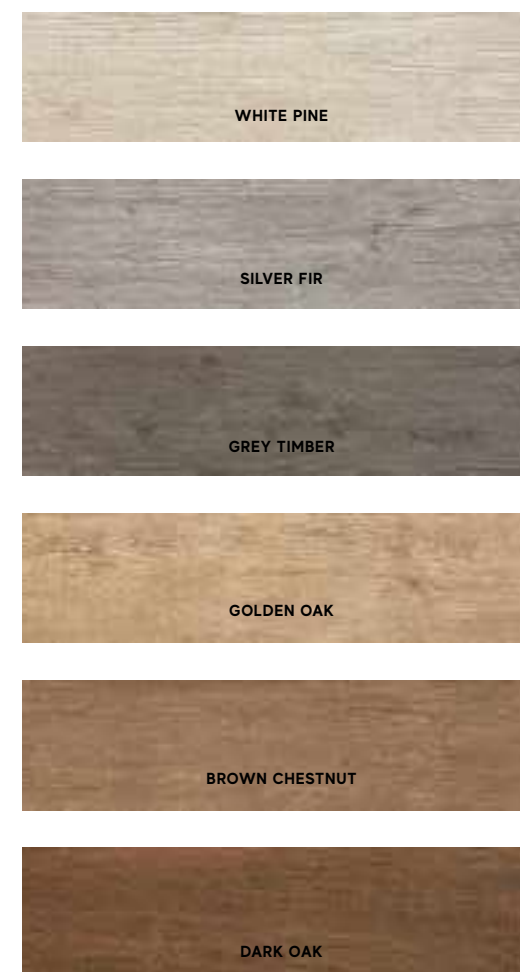

± 9.5 mm  
**22,5x90 cm** - 8<sup>7</sup>/<sub>8</sub>"x35<sup>3</sup>/<sub>8</sub>"  
AE7O Axi White Pine Strutturato  
AE7Q Axi Silver Fir Strutturato  
AE7R Axi Grey Timber Strutturato  
AE7P Axi Golden Oak Strutturato  
AE7S Axi Brown Chestnut Strutturato  
AE7T Axi Dark Oak Strutturato

### OUTDOOR ± 20 mm

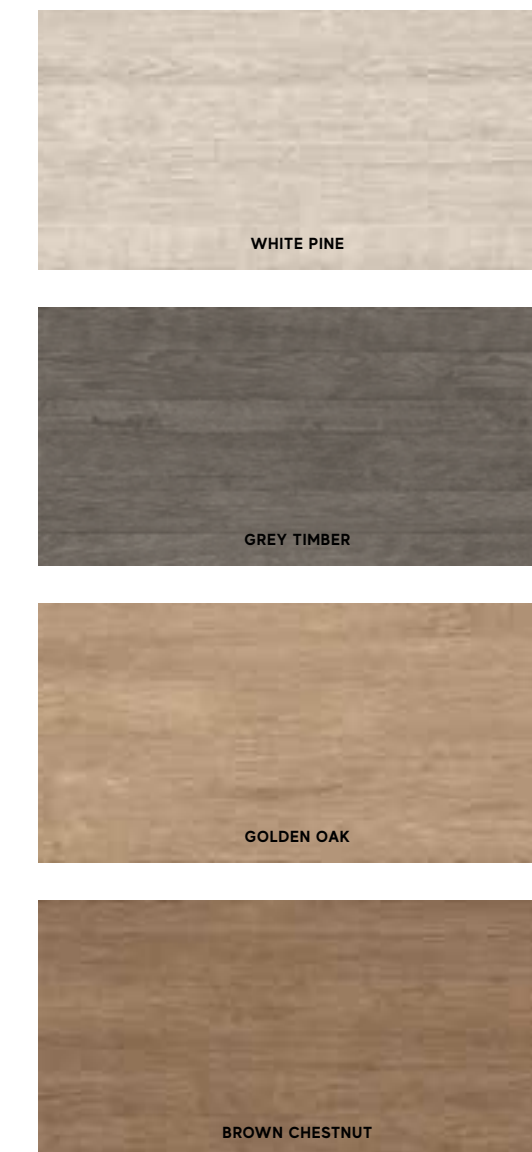

± 20 mm  
**45x90 cm** - 17<sup>3</sup>/<sub>4</sub>"x35<sup>3</sup>/<sub>8</sub>"  
ADU5 Axi White Pine 20 mm  
ADU7 Axi Grey Timber 20 mm  
ADU6 Axi Golden Oak 20 mm  
ADU8 Axi Brown Chestnut 20 mm

\* White Pine, Silver Fir, Grey Timber, Dark Oak  
\*\* Golden Oak, Brown Chestnut

**Matte surface** - Superficie matt - Surface Mat - Matte Oberfläche - Superficie Mate - Матовая поверхность  
**Textured surface** - Superficie strutturata - Surface structuré - Strukturierte Oberfläche - Superficie estructurado - Структурная поверхность  
**Outdoor** - Pavimenti da esterno - Sols d'extérieur - Bodenbeläge für Außenbereiche - Pavimentos para exteriores - Уличная плитка



# Axi

## Porcelain Tiles

### DECOR RANGE

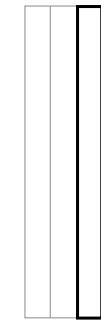

7,2x89,5 cm  
2<sup>7</sup>/<sub>8</sub>"x35<sup>1</sup>/<sub>4</sub>"

AMWG Axi White Pine Tatami 22,5x90 - 8<sup>7</sup>/<sub>8</sub>"x35<sup>1</sup>/<sub>4</sub>"  
 AMWI Axi Silver Fir Tatami 22,5x90 - 8<sup>7</sup>/<sub>8</sub>"x35<sup>1</sup>/<sub>4</sub>"  
 AMWJ Axi Grey Timber Tatami 22,5x90 - 8<sup>7</sup>/<sub>8</sub>"x35<sup>1</sup>/<sub>4</sub>"  
 AMWH Axi Golden Oak Tatami 22,5x90 - 8<sup>7</sup>/<sub>8</sub>"x35<sup>1</sup>/<sub>4</sub>"  
 AMWK Axi Brown Chestnut Tatami 22,5x90 - 8<sup>7</sup>/<sub>8</sub>"x35<sup>1</sup>/<sub>4</sub>"  
 AMWL Axi Dark Oak Tatami 22,5x90 - 8<sup>7</sup>/<sub>8</sub>"x35<sup>1</sup>/<sub>4</sub>"

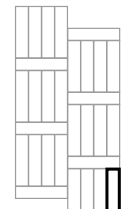

3,3x14 cm  
1<sup>1</sup>/<sub>4</sub>"x5<sup>1</sup>/<sub>2</sub>"

AMWM Axi White Pine Treccia 28x53 - 11"x20<sup>7</sup>/<sub>8</sub>"  
 AMWO Axi Silver Fir Treccia 28x53 - 11"x20<sup>7</sup>/<sub>8</sub>"  
 AMWP Axi Grey Timber Treccia 28x53 - 11"x20<sup>7</sup>/<sub>8</sub>"  
 AMWN Axi Golden Oak Treccia 28x53 - 11"x20<sup>7</sup>/<sub>8</sub>"  
 AMWQ Axi Brown Chestnut Treccia 28x53 - 11"x20<sup>7</sup>/<sub>8</sub>"  
 AMWR Axi Dark Oak Treccia 28x53 - 11"x20<sup>7</sup>/<sub>8</sub>"



ANIO Axi Bottone Decorato Mix 4  
7,5x7,5 - 3"x3"

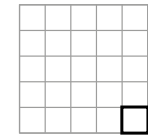

6,9x6,9 cm  
2<sup>7</sup>/<sub>8</sub>"x2<sup>7</sup>/<sub>8</sub>"



AMV7 Axi White Pine Mosaico 3D ▲ 35x35 - 13<sup>3</sup>/<sub>4</sub>"x13<sup>3</sup>/<sub>4</sub>"  
 AMV1 Axi Silver Fir Mosaico 3D ▲ 35x35 - 13<sup>3</sup>/<sub>4</sub>"x13<sup>3</sup>/<sub>4</sub>"  
 AMV4 Axi Grey Timber Mosaico 3D ▲ 35x35 - 13<sup>3</sup>/<sub>4</sub>"x13<sup>3</sup>/<sub>4</sub>"  
 AMVØ Axi Golden Oak Mosaico 3D ▲ 35x35 - 13<sup>3</sup>/<sub>4</sub>"x13<sup>3</sup>/<sub>4</sub>"



AMV8 Axi Brown Chestnut Mosaico 3D ▲ 35x35 - 13<sup>3</sup>/<sub>4</sub>"x13<sup>3</sup>/<sub>4</sub>"  
 AMV9 Axi Dark Oak Mosaico 3D ▲ 35x35 - 13<sup>3</sup>/<sub>4</sub>"x13<sup>3</sup>/<sub>4</sub>"

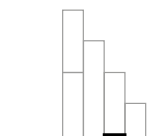

5x29 cm - 2"x11<sup>1</sup>/<sub>8</sub>"  
5x15 cm - 2"x5<sup>7</sup>/<sub>8</sub>"



AMWA White Pine Brick 3D ▲ 20x44 - 7<sup>7</sup>/<sub>8</sub>"x17<sup>3</sup>/<sub>8</sub>"  
 AMWC Axi Silver Fir Brick 3D ▲ 20x44 - 7<sup>7</sup>/<sub>8</sub>"x17<sup>3</sup>/<sub>8</sub>"  
 AMWD Axi Grey Timber Brick 3D ▲ 20x44 - 7<sup>7</sup>/<sub>8</sub>"x17<sup>3</sup>/<sub>8</sub>"  
 AMWB Axi Golden Oak Brick 3D ▲ 20x44 - 7<sup>7</sup>/<sub>8</sub>"x17<sup>3</sup>/<sub>8</sub>"  
 AMWE Axi Brown Chestnut Brick 3D ▲ 20x44 - 7<sup>7</sup>/<sub>8</sub>"x17<sup>3</sup>/<sub>8</sub>"  
 AMWF Axi Dark Oak Brick 3D ▲ 20x44 - 7<sup>7</sup>/<sub>8</sub>"x17<sup>3</sup>/<sub>8</sub>"

▲ Multi-thickness mosaic, close joint installation without grouting. - Mosaico multispessore, posa senza stuccatura a giunto unito. - Mosaïque multi-épaisseur, pose sans mastic avec joint nul. - Mosaik mit verschiedenen Stärken, fugenlose Verlegung ohne Mörtel. - Mosaico multiespesor, colocación sin mástique y sin juntas. - Мозаика разной толщины, укладка встык без затирки швов.

▲ The decoration can only be laid on the wall - Il decoro si può posare solo a rivestimento - Décor uniquement mural - Das Dekor kann nur an der Wand verlegt werden - La decoración se puede colocar únicamente en paredes - Декор может быть уложен только на стену.

INDEX



PRODUCT  
FINDER



SURFACE  
RANGE



COMPANY



COLLECTIONS



- 3D WALL
- CONCRETE & RESIN LOOK
- METAL LOOK
- MARBLE LOOK
- STONE LOOK
- WOOD LOOK

LARGE SIZES



TECHNICAL  
SPECIFICATIONS



# Axi

## Porcelain Tiles

### DECOR RANGE



LAYOUT 1



LAYOUT 2



ANIT Axi Brown Chestnut Rosone Mini ♦  
45x45 - 17<sup>1</sup>/<sub>4</sub>"x17<sup>1</sup>/<sub>4</sub>"



ANIQ Axi Angolo Elegance ♦  
90x90 - 35<sup>1</sup>/<sub>8</sub>"x35<sup>1</sup>/<sub>8</sub>"



ANIS Axi Fascia Elegance ♦  
90x90 - 35<sup>1</sup>/<sub>8</sub>"x35<sup>1</sup>/<sub>8</sub>"

Layout 1  
360x360 - 141<sup>1</sup>/<sub>4</sub>"x141<sup>1</sup>/<sub>4</sub>"

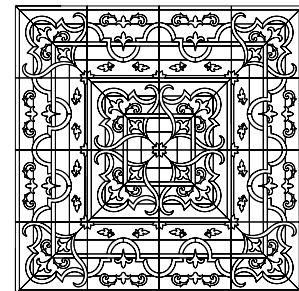

Layout 2  
180x180 - 70<sup>1</sup>/<sub>8</sub>"x70<sup>1</sup>/<sub>8</sub>"

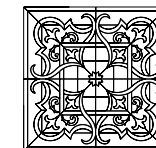

Layout 3  
180x360 - 70<sup>1</sup>/<sub>8</sub>"x141<sup>1</sup>/<sub>4</sub>"

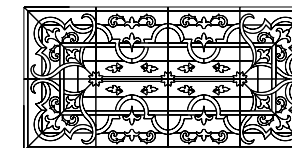

#### TRIM TILES

p. 462



p. 455

- White Pine
- Silver Fir
- Golden Oak
- Brown Chestnut
- Dark Oak
- Grey Timber

#### Battiscopa

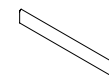

7,2x90 cm  
2<sup>7</sup>/<sub>8</sub>"x35<sup>1</sup>/<sub>8</sub>"

Matt

- ANLH
- ANLK
- ANLJ
- ANLM
- ANLN
- ANLL

#### Scalino \*

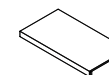

22,5x90 cm  
8<sup>7</sup>/<sub>8</sub>"x35<sup>1</sup>/<sub>8</sub>"

Matt

- ANLO
- ANLQ
- ANLP
- ANLT
- ANLU
- ANLR

#### Scalin Ang.\*

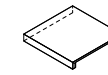

22,5x22,5 cm  
8<sup>7</sup>/<sub>8</sub>"x8<sup>7</sup>/<sub>8</sub>"

Matt

- |      |      |
|------|------|
| DX   | SX   |
| ANLV | ANL1 |
| ANLX | ANL2 |
| ANLW | ANL5 |
| ANLZ | ANL9 |
| ANLØ | ANL7 |
| ANLY | ANL4 |

#### Battiscopa Sag. Scala \*



7,2x30 cm  
2<sup>7</sup>/<sub>8</sub>"x11<sup>1</sup>/<sub>4</sub>"

Matt

- |      |      |
|------|------|
| DX   | SX   |
| ANMA | ANMG |
| ANMC | ANML |
| ANMB | ANMJ |
| ANME | ANMH |
| ANMF | ANMI |
| ANMD | ANMK |

#### Elemento L \*



22,5x90 H. 4 cm  
8<sup>7</sup>/<sub>8</sub>"x35<sup>1</sup>/<sub>8</sub>" H. 1<sup>1</sup>/<sub>4</sub>"

Strutturato

- ANMM
- ANMO
- ANMN
- ANMQ
- ANMR
- ANMP

♦ To be ordered in multiples of 4. - Ordinabile in multipli di 4 - Peut être commandé en multiples de 4. - Zum Bestellen als Vielfache von 4. - Es posible efectuar pedidos en múltiplos de 4. - Заказываются в количестве кратном 4.

\* These parts are supplied to order - I pezzi sono disponibili su ordinazione - Les pièces sont disponibles sur commande - Die Teile sind auf Bestellung lieferbar - Las piezas se hacen por encargo - Изготавливаются на заказ

INDEX



PRODUCT  
FINDER



SURFACE  
RANGE



COMPANY



COLLECTIONS



- 3D WALL
- CONCRETE & RESIN LOOK
- METAL LOOK
- MARBLE LOOK
- STONE LOOK
- WOOD LOOK

LARGE SIZES



TECHNICAL  
SPECIFICATIONS



# Etic

DOWNLOAD >  
CATALOG &  
IMAGE GALLERY

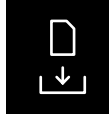

© Ceramiche Atlas Concorde



© Ceramiche Atlas Concorde



© Ceramiche Atlas Concorde

## Porcelain Tiles



ROVERE BIANCO



ROVERE



NOCE



ROVERE GRIGIO

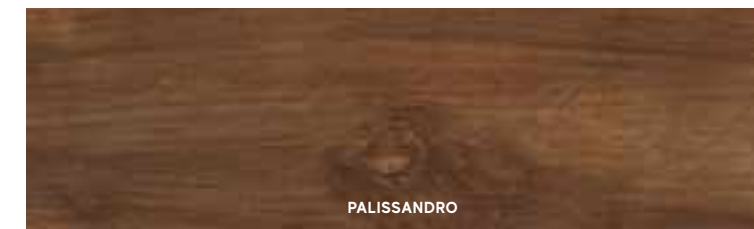

PALISSANDRO

### COLOURED BODY PORCELAIN TILES - RECTIFIED MONOCALIBER

Sizes	Thickness	Surface finish
22,5x90 cm - 8 <sup>7</sup> / <sub>8</sub> "x35 <sup>1</sup> / <sub>8</sub> "	± 9,5 mm	Matte R9 A
15x90 cm - 5 <sup>7</sup> / <sub>8</sub> "x35 <sup>1</sup> / <sub>8</sub> "	± 9,5 mm	Matte R9 A

Coloured body porcelain tiles - Gres porcellanato colorato in massa - Grès cérame coloré dans la masse - Durchgefärbtes Feinsteinzeug - Gres porcelánico coloreado en masa - Керамический гранит окрашенный в массе  
 Rectified monocaliber - Rettificato monocalibro - Rectifié mono-calibre - Geschliffen einkalbrig - Rectificado monocalibre - Ретифицированный в одном калибре

INDEX



PRODUCT  
FINDER



SURFACE  
RANGE



COMPANY



COLLECTIONS



- 3D WALL
- CONCRETE & RESIN LOOK
- METAL LOOK
- MARBLE LOOK
- STONE LOOK
- WOOD LOOK

LARGE SIZES



TECHNICAL  
SPECIFICATIONS



# Etic

## Porcelain Tiles



### MATTE SURFACE

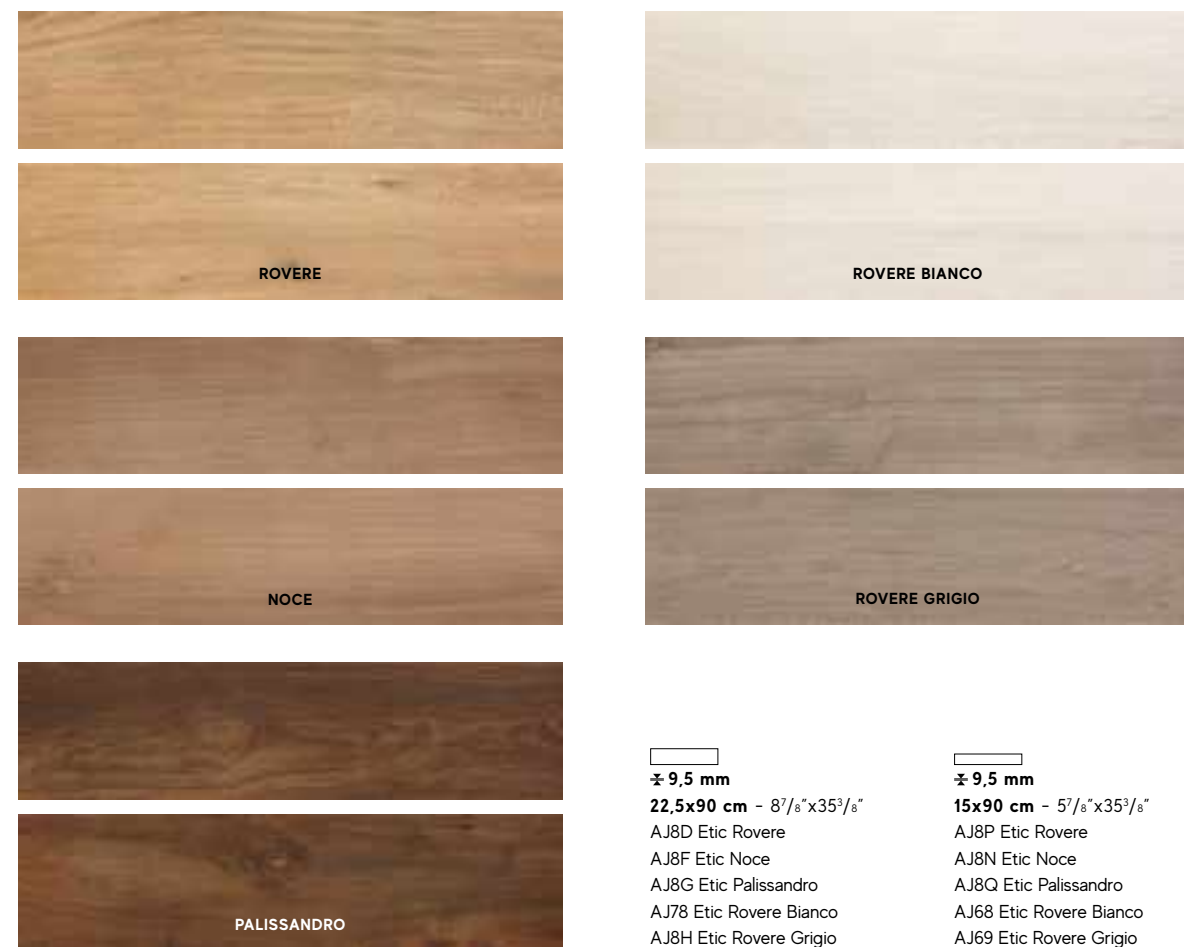

**± 9,5 mm**  
**22,5x90 cm** - 8<sup>7</sup>/<sub>8</sub>"x35<sup>3</sup>/<sub>8</sub>"  
 AJ8D Etic Rovere  
 AJ8F Etic Noce  
 AJ8G Etic Palissandro  
 AJ78 Etic Rovere Bianco  
 AJ8H Etic Rovere Grigio

**± 9,5 mm**  
**15x90 cm** - 5<sup>7</sup>/<sub>8</sub>"x35<sup>3</sup>/<sub>8</sub>"  
 AJ8P Etic Rovere  
 AJ8N Etic Noce  
 AJ8Q Etic Palissandro  
 AJ68 Etic Rovere Bianco  
 AJ69 Etic Rovere Grigio

### TRIM TILES

p. 462



p. 455

	Battiscopa	Scalino *	Scalino Ang.*	Battiscopa Sag. Scala *
	7,2x90 cm 2 <sup>7</sup> / <sub>8</sub> "x35 <sup>3</sup> / <sub>8</sub> " Matt	22,5x90 cm 8 <sup>7</sup> / <sub>8</sub> "x35 <sup>3</sup> / <sub>8</sub> " Matt	22,5x22,5 cm 8 <sup>7</sup> / <sub>8</sub> "x8 <sup>7</sup> / <sub>8</sub> " Matt	7,2x30 cm 2 <sup>7</sup> / <sub>8</sub> "x11 <sup>1</sup> / <sub>4</sub> " Matt
			DX SX	DX SX
	AM75	AM96	ANAE ANCV	ANAL ANCN
	AM76	AM97	ANAF ANCW	ANCH ANCO
	AM78	AM99	ANAH ANCZ	ANCI ANCQ
	AM79	ANAA	ANAI ANC1	ANCK ANCR
	AM8A	ANAC	ANAJ ANCØ	ANCL ANCS

\* These parts are supplied to order - I pezzi sono disponibili su ordinazione - Les pièces sont disponibles sur commande - Die Teile sind auf Bestellung lieferbar - Las piezas se hacen por encargo - Изготавливаются на заказ

\* Rovere Bianco  
 \*\* Rovere, Rovere Grigio, Noce, Palissandro  
**Matte surface** - Superficie matt - Surface Mat - Matte Oberfläche - Superficie Mate - Матовая поверхность

### DECOR RANGE

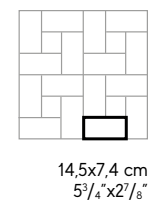
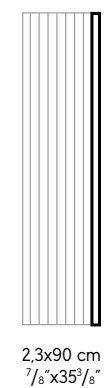

INDEX



PRODUCT  
FINDER



SURFACE  
RANGE



COMPANY



COLLECTIONS



- 3D WALL
- CONCRETE & RESIN LOOK
- METAL LOOK
- MARBLE LOOK
- STONE LOOK
- WOOD LOOK

LARGE SIZES



TECHNICAL  
SPECIFICATIONS



# Etic Pro

DOWNLOAD >  
CATALOG &  
IMAGE GALLERY

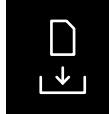

© Ceramiche Atlas Concorde



© Ceramiche Atlas Concorde



© Ceramiche Atlas Concorde

## Porcelain Tiles

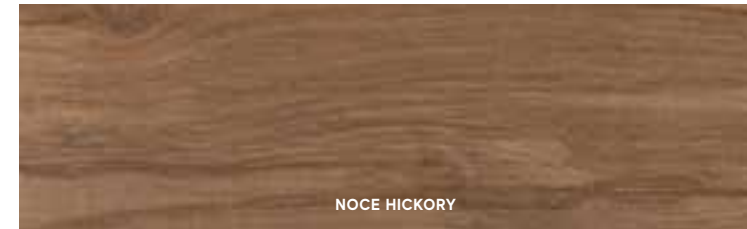

### COLOURED BODY PORCELAIN TILES - RECTIFIED MONOCALIBER

Sizes	Thickness	Surface finish
25x150 cm - 9 <sup>7</sup> / <sub>8</sub> "x59"	± 9 mm	Matte R9 A
22,5x90 cm - 8 <sup>7</sup> / <sub>8</sub> "x35 <sup>3</sup> / <sub>8</sub> "	± 9 mm	Matte R9 A
15x90 cm - 5 <sup>7</sup> / <sub>8</sub> "x35 <sup>3</sup> / <sub>8</sub> "	± 9 mm	Matte R9 A

### OUTDOOR PAVING AND WET AREAS

Sizes	Thickness	Surface finish
22,5x90 cm - 8 <sup>7</sup> / <sub>8</sub> "x35 <sup>3</sup> / <sub>8</sub> "	± 9 mm	Grip R11 A+B+C
30x120 cm - 11 <sup>1</sup> / <sub>4</sub> "x47 <sup>1</sup> / <sub>4</sub> "	± 20 mm	Outdoor R11 A+B+C

INDEX



PRODUCT  
FINDER



SURFACE  
RANGE



COMPANY



COLLECTIONS



- 3D WALL
- CONCRETE & RESIN LOOK
- METAL LOOK
- MARBLE LOOK
- STONE LOOK
- WOOD LOOK

LARGE SIZES



TECHNICAL  
SPECIFICATIONS



Coloured body porcelain tiles - Gres porcellanato colorato in massa - Grès cérame coloré dans la masse - Durchgefärbtes Feinsteinzeug - Gres porcelánico coloreado en masa - Керамический гранит окрашенный в массе  
Rectified monocaliber - Rettificato monocalibro - Rectifié mono-calibre - Geschliffen einkalibrig - Rectificado monocalibre - Ретифицированный в одном калибре



# Etic Pro

## Porcelain Tiles

### MATTE SURFACE

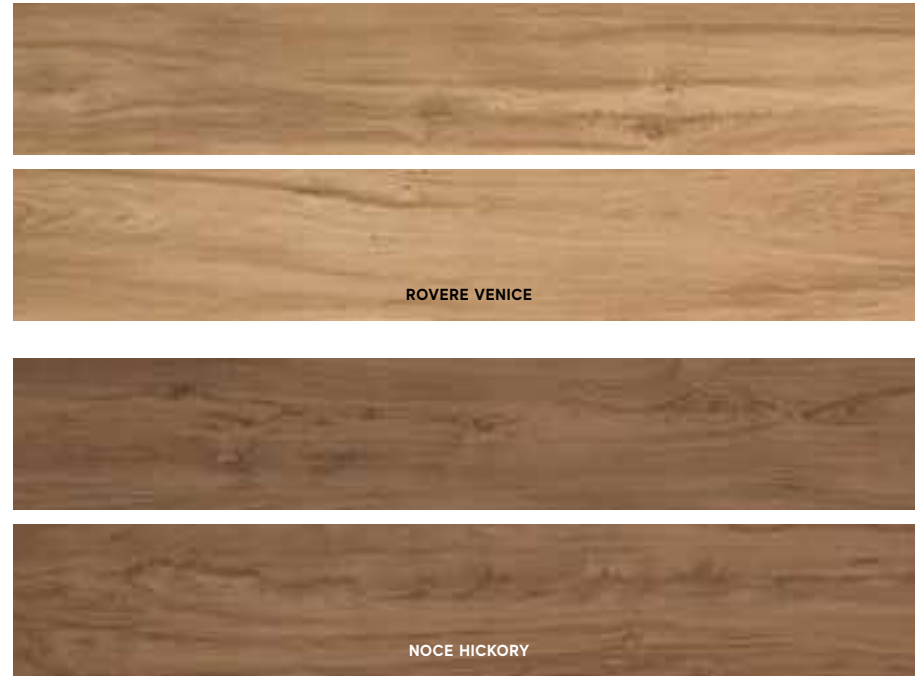

<p><b>± 9 mm</b>  <b>25x150 cm</b> - 9<sup>7/8</sup>"x59"                  AV4I Etic Rovere Venice                  AV4K Etic Noce Hickory</p>	<p><b>± 9 mm</b>  <b>22,5x90 cm</b> - 8<sup>7/8</sup>"x35<sup>3/8</sup>"                  AV4M Etic Rovere Venice                  AV4O Etic Noce Hickory</p>	<p><b>± 9 mm</b>  <b>15x90 cm</b> - 5<sup>7/8</sup>"x35<sup>3/8</sup>"                  D183 Etic Rovere Venice                  D185 Etic Noce Hickory</p>
--	---	---



### GRIP SURFACE

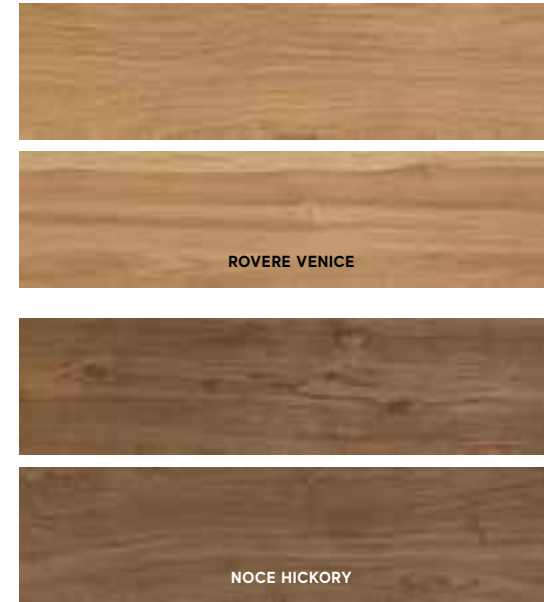

<p><b>± 9 mm</b>  <b>22,5x90 cm</b> - 8<sup>7/8</sup>"x35<sup>3/8</sup>"                  AV4Y Etic Rovere Venice Grip                  AV4Ø Etic Noce Hickory Grip</p>
---



### OUTDOOR ± 20 mm

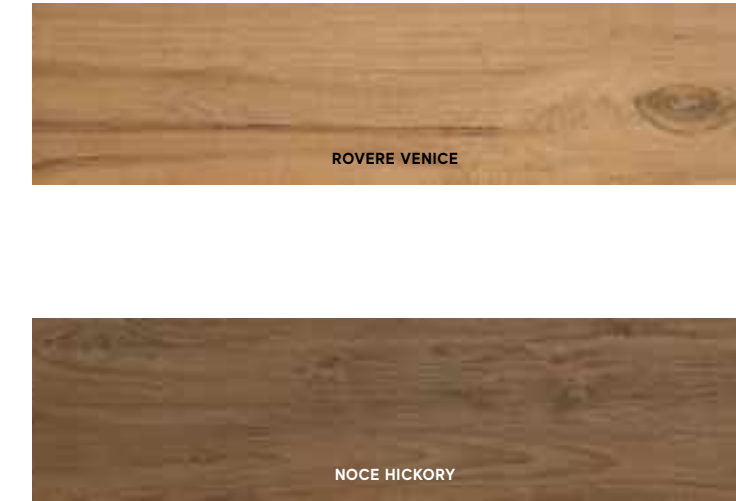

<p><b>± 20 mm</b>  <b>30x120 cm</b> - 11<sup>3/4</sup>"x47<sup>1/4</sup>"                  AV42 Etic Rovere Venice 20mm                  AV44 Etic Noce Hickory 20mm</p>
--



**Matte surface** - Superficie matt - Surface Mat - Matte Oberfläche - Superficie Mate - Матовая поверхность  
**Grip surface** - Superficie grip - Surface grip - Grip Oberfläche - Superficie Grip - Grip поверхность  
**Outdoor** - Pavimenti da esterno - Sols d'extérieur - Bodenbeläge für Außenbereiche - Pavimentos para exteriores - Уличная плитка

\* These parts are supplied to order - I pezzi sono disponibili su ordinazione - Les pièces sont disponibles sur commande - Die Teile sind auf Bestellung lieferbar - Las piezas se hacen por encargo - Изготавливаются на заказ

TRIM TILES p. 462	Battiscopa	Scalino *	Scalino *	Scalin Ang.*	Battiscopa Sag. Scala *	Elemento L *
	7,2x90 cm 2 <sup>7/8</sup> "x35 <sup>3/8</sup> " Matt	22,5x90 cm 8 <sup>7/8</sup> "x35 <sup>3/8</sup> " Matt	33x150 cm 13"x59" Matt	22,5x22,5 cm 8 <sup>7/8</sup> "x8 <sup>7/8</sup> " Matt	7,2x30 cm 2 <sup>7/8</sup> "x11 <sup>3/4</sup> " Matt	22,5x90 H. 4 cm 8 <sup>7/8</sup> "x35 <sup>3/8</sup> " H. 1 <sup>1/8</sup> " Grip
				DX SX	DX SX	
	AV68	AV7Z	AZFC	AV78 AV73	AV8G AV8C	AV8K
	AV7A	AV71	AZSH	AV8A AV75	AV8I AV8E	AV8M

INDEX



PRODUCT  
FINDER



SURFACE  
RANGE



COMPANY



COLLECTIONS



- 3D WALL
- CONCRETE & RESIN LOOK
- METAL LOOK
- MARBLE LOOK
- STONE LOOK
- WOOD LOOK

LARGE SIZES



TECHNICAL  
SPECIFICATIONS



# Etic Pro

## Porcelain Tiles



AWVZ Etic Rovere Venice  
Tatami  
22,5x90 - 8<sup>7</sup>/<sub>8</sub>"x35<sup>3</sup>/<sub>8</sub>"



AWV1 Etic Noce Hickory  
Tatami  
22,5x90 - 8<sup>7</sup>/<sub>8</sub>"x35<sup>3</sup>/<sub>8</sub>"

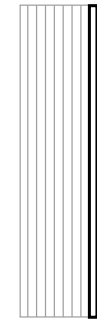

2,3x90 cm  
7<sup>1</sup>/<sub>8</sub>"x35<sup>3</sup>/<sub>8</sub>"



AWV7 Etic Rovere Venice  
Chevron A+B  
35x34,5 - 13<sup>3</sup>/<sub>4</sub>"x13<sup>3</sup>/<sub>8</sub>"



AWV9 Etic Noce Hickory  
Chevron A+B  
35x34,5 - 13<sup>3</sup>/<sub>4</sub>"x13<sup>3</sup>/<sub>8</sub>"

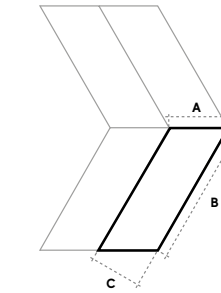

A 17 cm - 6<sup>3</sup>/<sub>4</sub>"  
B 39,8 cm - 15<sup>5</sup>/<sub>8</sub>"  
C 14,7 cm - 5<sup>3</sup>/<sub>4</sub>"



AWY1 Etic Rovere Venice  
Industrial 3D ▲  
44x28,5 - 17<sup>3</sup>/<sub>8</sub>"x11<sup>1</sup>/<sub>4</sub>"



AWYK Etic Noce Hickory  
Industrial 3D ▲  
44x28,5 - 17<sup>3</sup>/<sub>8</sub>"x11<sup>1</sup>/<sub>4</sub>"

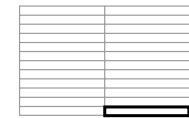

2,4x22 cm  
1"x8<sup>5</sup>/<sub>8</sub>"



AWV3 Etic Rovere Venice  
Herringbone  
36,2x41,2 - 14<sup>1</sup>/<sub>8</sub>"x16<sup>1</sup>/<sub>8</sub>"



AWV5 Etic Noce Hickory  
Herringbone  
36,2x41,2 - 14<sup>1</sup>/<sub>8</sub>"x16<sup>1</sup>/<sub>8</sub>"

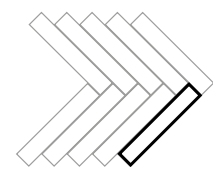

4,9x29 cm  
1<sup>7</sup>/<sub>8</sub>"x11<sup>1</sup>/<sub>8</sub>"



AWYE Etic Rovere Venice  
Chevron Tatami A+B  
74x22,2 - 29<sup>1</sup>/<sub>8</sub>"x8<sup>5</sup>/<sub>8</sub>"

AWYG Etic Noce Hickory  
Chevron Tatami A+B  
74x22,2 - 29<sup>1</sup>/<sub>8</sub>"x8<sup>5</sup>/<sub>8</sub>"

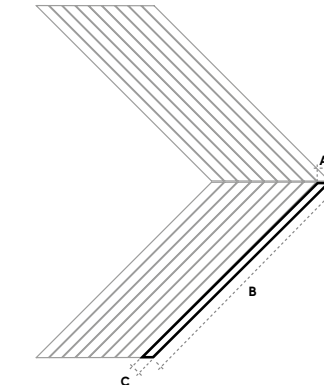

A 3,2 cm - 1<sup>1</sup>/<sub>4</sub>"  
B 73,8 cm - 29"  
C 2,3 cm - 7<sup>1</sup>/<sub>8</sub>"

▲ Multi-thickness mosaic, close joint installation without grouting. - Mosaico multispessore, posa senza stuccatura a giunto unito. - Mosaïque multi-épaisseur, pose sans mastic avec joint nul. - Mosaik mit verschieden Stärken, fugenlose Verlegung ohne Mörtel. - Mosaico multiespesor, colocación sin mástique y sin juntas. - Мозаика разной толщины, укладка встык без затирки швов.

■ The decoration can only be laid on the wall. - Il decoro si può posare solo a rivestimento. - Décor uniquement mural. - Das Dekor kann nur an der Wand verlegt werden. - La decoración se puede colocar únicamente en paredes. - Декор может быть уложен только на стену.

INDEX



PRODUCT  
FINDER



SURFACE  
RANGE



COMPANY



COLLECTIONS



- 3D WALL
- CONCRETE & RESIN LOOK
- METAL LOOK
- MARBLE LOOK
- STONE LOOK
- WOOD LOOK

LARGE SIZES



TECHNICAL  
SPECIFICATIONS



# Exence

DOWNLOAD >  
CATALOG &  
IMAGE GALLERY

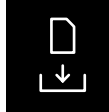

© Ceramiche Atlas Concorde



© Ceramiche Atlas Concorde



© Ceramiche Atlas Concorde

## Porcelain Tiles



VANILLA



ALMOND

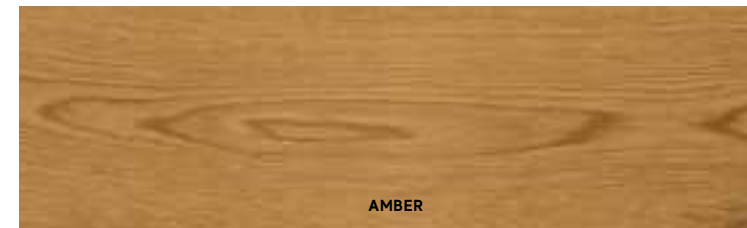

AMBER



VANILLA SAW CUT



ALMOND SAW CUT

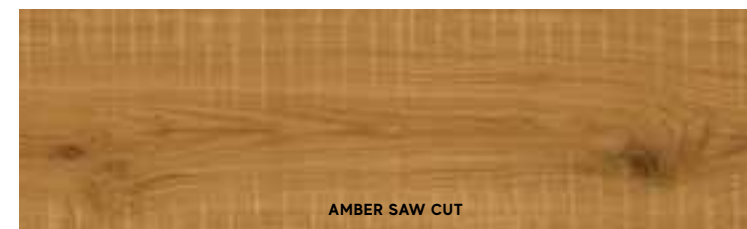

AMBER SAW CUT

### COLOURED BODY PORCELAIN TILES - RECTIFIED MONOCALIBER

Sizes	Thickness	Surface finish
18,5x150 cm - 7 <sup>1</sup> / <sub>4</sub> "x59"	± 9 mm	Matte R10 A+B
20x120 cm - 7 <sup>7</sup> / <sub>8</sub> "x47 <sup>1</sup> / <sub>4</sub> "	± 9 mm	Matte R10 A+B

### OUTDOOR PAVING AND WET AREAS

Sizes	Thickness	Surface finish
18,5x150 cm - 7 <sup>1</sup> / <sub>4</sub> "x59"	± 9 mm	Grip R11 A+B+C
30x120 cm - 11 <sup>1</sup> / <sub>4</sub> "x47 <sup>1</sup> / <sub>4</sub> "	± 20 mm	Outdoor R11 A+B+C

Coloured body porcelain tiles - Gres porcellanato colorato in massa - Grès cérame coloré dans la masse - Durchgefärbtes Feinsteinzeug - Gres porcelánico coloreado en masa - Керамический гранит окрашенный в массе  
 Rectified monocaliber - Rettificato monocalibro - Rectifié mono-calibre - Geschliffen einkalbrig - Rectificado monocalibre - Ретифицированный в одном калибре

INDEX



PRODUCT  
FINDER



SURFACE  
RANGE



COMPANY



COLLECTIONS



- 3D WALL
- CONCRETE & RESIN LOOK
- METAL LOOK
- MARBLE LOOK
- STONE LOOK
- WOOD LOOK

LARGE SIZES



TECHNICAL  
SPECIFICATIONS



# Exence

## Porcelain Tiles

### MATTE SURFACE



± 9 mm  
**18,5x150 cm** - 7 1/4" x 59"  
 AO4H Exence Vanilla  
 AL87 Exence Almond  
 AL88 Exence Amber

± 9 mm  
**20x120 cm** - 7 7/8" x 47 1/4"  
 AO47 Exence Vanilla  
 AO48 Exence Almond  
 AO49 Exence Amber



### MATTE SURFACE - SAW CUT

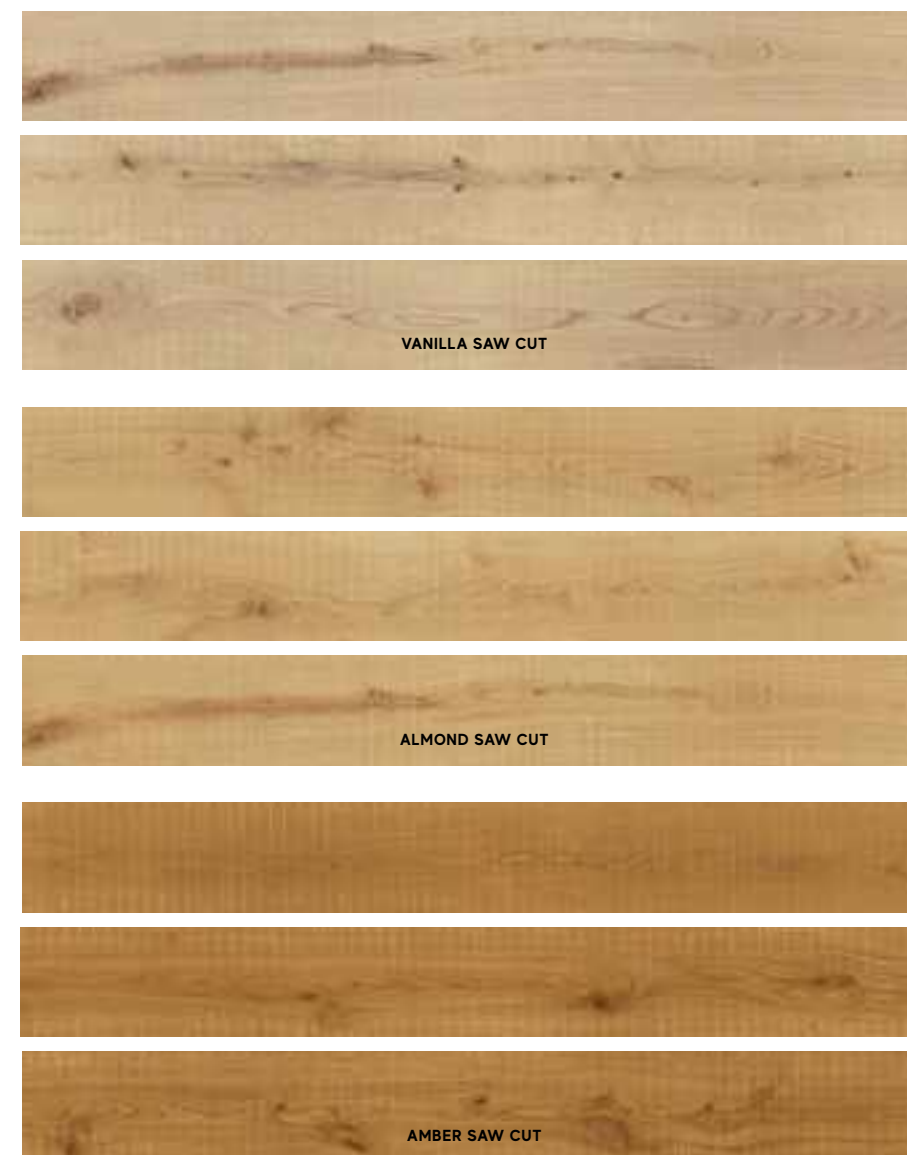

± 9 mm  
**18,5x150 cm** - 7 1/4" x 59"  
 AO4N Exence Vanilla Saw Cut  
 AO4L Exence Almond Saw Cut  
 AO4M Exence Amber Saw Cut



- 3D WALL
- CONCRETE & RESIN LOOK
- METAL LOOK
- MARBLE LOOK
- STONE LOOK
- WOOD LOOK



# Exence

## Porcelain Tiles

### GRIP SURFACE



± 9 mm  
**18,5x150 cm** - 7 1/4" x 59"  
 AOJK Exence Vanilla Grip  
 AOJL Exence Almond Grip  
 AOJN Exence Amber Grip

**H** HEAVY TRAFFIC  
 Grip ± 9 mm  
 Outdoor ± 20 mm

**R11 A+B+C** Grip ± 9 mm  
**R11 A+B+C** Outdoor ± 20 mm

V2 Slight Variation



### OUTDOOR ± 20 mm



± 20 mm  
**30x120 cm** - 11 3/4" x 47 1/4"  
 A2RY Exence Almond 20 mm  
 A2RZ Exence Amber 20 mm



**Grip surface** - Superficie grip - Surface grip - Grip Oberfläche - Superficie Grip - Grip поверхность  
**Outdoor** - Pavimenti da esterno - Sols d'extérieur - Bodenbeläge für Außenbereiche - Pavimentos para exteriores - Уличная плитка

INDEX



PRODUCT  
FINDER



SURFACE  
RANGE



COMPANY



COLLECTIONS







- 3D WALL
- CONCRETE & RESIN LOOK
- METAL LOOK
- MARBLE LOOK
- STONE LOOK
- WOOD LOOK

LARGE SIZES



TECHNICAL  
SPECIFICATIONS

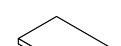
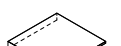

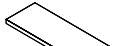
TRIM TILES p. 462	Battiscopa		Scalino *	Scalin Ang.*	Battiscopa Sag. Scala *		Elemento L *	
								
7,2x150 cm 2 1/2" x 59"	7,2x120 cm 2 1/2" x 47 1/4"	33x150 cm 13" x 59"	33x33 cm 13" x 13"	7,2x30 cm 2 1/2" x 11 1/4"	18,5x150 H. 4 cm 7 1/4" x 59" H. 1 1/2"			
Matt	Matt	Matt	Matt	Matt			Grip	
				DX SX	DX SX			
Vanilla	AOUX	APC4	AOUY	AOUZ	AOUØ	AOU1	AOU2	AOZI
Almond	AMA2	APC5	AMA6	AMA8	AMBA	AMBE	AMBG	AOZJ
Amber	AMA5	APC6	AMA7	AMA9	AMBD	AMBF	AMBH	AOZK

\* These parts are supplied to order - I pezzi sono disponibili su ordinazione - Les pièces sont disponibles sur commande - Die Teile sind auf Bestellung lieferbar - Las piezas se hacen por encargo - Изготавливаются на заказ

# Exence Porcelain Tiles

## DECOR RANGE



AOOU Exence  
Vanilla Square  
56,1x56,1 - 22"x22"



AOUV Exence  
Almond Square  
56,1x56,1 - 22"x22"



AOJW Exence  
Amber Square  
56,1x56,1 - 22"x22"



AOUR Exence  
Vanilla Tatami  
18,5x75 - 7 1/4"x29 1/2"



AOUS Exence  
Almond Tatami  
18,5x75 - 7 1/4"x29 1/2"



AOUT Exence  
Amber Tatami  
18,5x75 - 7 1/4"x29 1/2"



AOUG Exence  
Vanilla Chevron  
32,5x45 - 12 1/4"x17 1/4"



AMBJ Exence  
Almond Chevron  
32,5x45 - 12 1/4"x17 1/4"



AMBL Exence  
Amber Chevron  
32,5x45 - 12 1/4"x17 1/4"



© Ceramiche Atlas Concorde



© Ceramiche Atlas Concorde

INDEX



PRODUCT  
FINDER



SURFACE  
RANGE



COMPANY



COLLECTIONS



- 3D WALL
- CONCRETE & RESIN LOOK
- METAL LOOK
- MARBLE LOOK
- STONE LOOK
- WOOD LOOK

LARGE SIZES



TECHNICAL  
SPECIFICATIONS



# Heartwood

DOWNLOAD >  
CATALOG &  
IMAGE GALLERY



© Ceramiche Atlas Concorde



© Ceramiche Atlas Concorde



© Ceramiche Atlas Concorde

## Porcelain Tiles



MALT

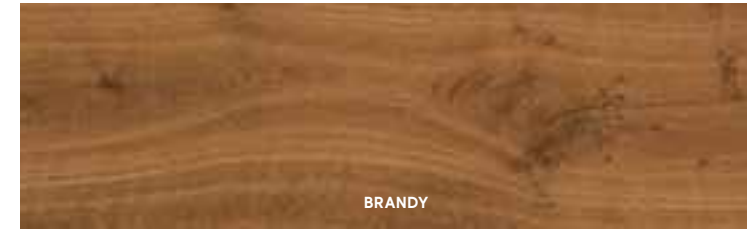

BRANDY

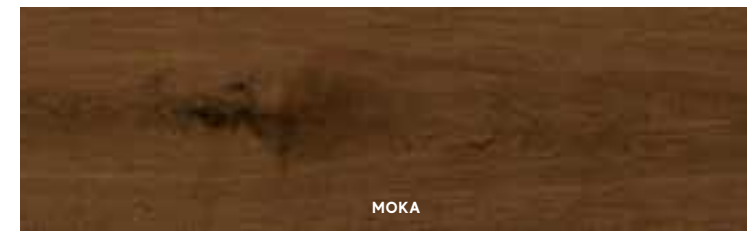

MOKA

### COLOURED BODY PORCELAIN TILES - RECTIFIED MONOCALIBER

Sizes	Thickness	Surface finish
18,5x150 cm - 7 1/4" x 59"	± 9 mm	Matte R9 A
20x120 cm - 7 7/8" x 47 1/4"	± 9 mm	Matte R10 A+B

INDEX



PRODUCT  
FINDER



SURFACE  
RANGE



COMPANY



COLLECTIONS



- 3D WALL
- CONCRETE & RESIN LOOK
- METAL LOOK
- MARBLE LOOK
- STONE LOOK
- WOOD LOOK

LARGE SIZES



TECHNICAL  
SPECIFICATIONS



Coloured body porcelain tiles - Gres porcellanato colorato in massa - Grès cérame coloré dans la masse - Durchgefärbtes Feinsteinzeug - Gres porcelánico coloreado en masa - Керамический гранит окрашенный в массе  
Rectified monocaliber - Rettificato monocalibro - Rectifié mono-calibre - Geschliffen einkalbrig - Rectificado monocalibre - Ретифицированный в одном калибре

# Heartwood

## Porcelain Tiles

**H** HEAVY TRAFFIC  
 Matte ± 9 mm  
**R9 A** Matte 18,5x150 cm ± 9 mm  
**R10 A+B** Matte 20x120 cm ± 9 mm  
 V3 Moderate Variation



### MATTE SURFACE



± 9 mm  
**18,5x150 cm** - 7<sup>1</sup>/<sub>8</sub>"x59"  
 AL68 Heartwood Malt  
 AL84 Heartwood Brandy  
 AL69 Heartwood Moka

± 9 mm  
**20x120 cm** - 7<sup>7</sup>/<sub>8</sub>"x47<sup>1</sup>/<sub>4</sub>"  
 AL7E Heartwood Malt  
 AL85 Heartwood Brandy  
 AL7F Heartwood Moka

### DECOR RANGE



AOYG Heartwood Malt  
 Mansion Weave  
 34,6x40 - 13<sup>3</sup>/<sub>8</sub>"x15<sup>3</sup>/<sub>4</sub>"



AOYH Heartwood Brandy  
 Mansion Weave  
 34,6x40 - 13<sup>3</sup>/<sub>8</sub>"x15<sup>3</sup>/<sub>4</sub>"



AOYI Heartwood Moka  
 Mansion Weave  
 34,6x40 - 13<sup>3</sup>/<sub>8</sub>"x15<sup>3</sup>/<sub>4</sub>"



AO3K Heartwood Malt  
 Marble Chevron  
 29,4x28,7 - 11<sup>5</sup>/<sub>8</sub>"x11<sup>1</sup>/<sub>8</sub>"  
 Malt + Marvel Black Atlantis



AO3L Heartwood Brandy  
 Marble Chevron  
 29,4x28,7 - 11<sup>5</sup>/<sub>8</sub>"x11<sup>1</sup>/<sub>8</sub>"  
 Brandy + Marvel Black Atlantis



AOYI Heartwood Moka  
 Marble Chevron  
 29,4x28,7 - 11<sup>5</sup>/<sub>8</sub>"x11<sup>1</sup>/<sub>8</sub>"  
 Moka + Marvel Black Atlantis



AOYD Heartwood Malt Tatami  
 18,5x75 - 7<sup>1</sup>/<sub>4</sub>"x29<sup>1</sup>/<sub>2</sub>"



AOYE Heartwood Brandy Tatami  
 18,5x75 - 7<sup>1</sup>/<sub>4</sub>"x29<sup>1</sup>/<sub>2</sub>"



AOYF Heartwood Moka Tatami  
 18,5x75 - 7<sup>1</sup>/<sub>4</sub>"x29<sup>1</sup>/<sub>2</sub>"

TRIM TILES  
 p. 462  
  
 p. 455



	Battiscopa	Scalino *	Scalin Ang.*	Battiscopa Sag. Scala *
	7,2x150 cm 2 <sup>7</sup> / <sub>8</sub> "x59" Matt	7,2x120 cm 2 <sup>7</sup> / <sub>8</sub> "x47 <sup>1</sup> / <sub>4</sub> " Matt	33x150 cm 13"x59" Matt	7,2x30 cm 2 <sup>7</sup> / <sub>8</sub> "x11 <sup>1</sup> / <sub>4</sub> " Matt
Malt	AMAH	AMAE	AMAK	AMAW
Brandy	AMAI	AMAF	AMAL	AMAX
Moka	AMAJ	AMAG	AMAM	AMAY
			DX AMAN	SX AMAR
				AMAZ
				AMAO AMAU
				AMAX AMAØ
				AMAY AMA1

\* These parts are supplied to order - I pezzi sono disponibili su ordinazione - Les pièces sont disponibles sur commande - Die Teile sind auf Bestellung lieferbar - Las piezas se hacen por encargo - Изготавливаются на заказ

INDEX



PRODUCT  
 FINDER



SURFACE  
 RANGE



COMPANY



COLLECTIONS



- 3D WALL
- CONCRETE & RESIN LOOK
- METAL LOOK
- MARBLE LOOK
- STONE LOOK
- WOOD LOOK

LARGE SIZES



TECHNICAL  
 SPECIFICATIONS





# Nid

DOWNLOAD >  
CATALOG &  
IMAGE GALLERY

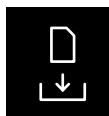

© Ceramiche Atlas Concorde



© Ceramiche Atlas Concorde



© Ceramiche Atlas Concorde

## Porcelain Tiles



LIGHT

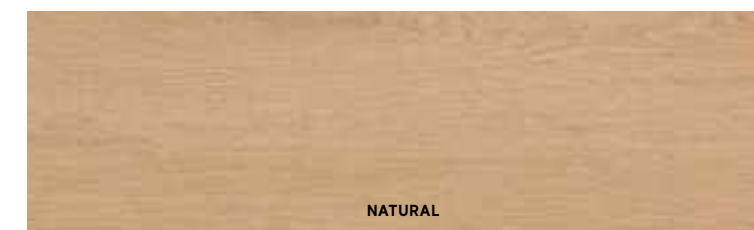

NATURAL



CASHMERE



WHISKY

### COLOURED BODY PORCELAIN TILES - RECTIFIED MONOCALIBER

Sizes	Thickness	Surface finish
25x150 cm - 9 <sup>7</sup> / <sub>8</sub> "x59"	± 9 mm	Matte R10 A
18,5x150 cm - 7 <sup>1</sup> / <sub>4</sub> "x59"	± 9 mm	Matte R10 A
15x90 cm - 5 <sup>7</sup> / <sub>8</sub> "x35 <sup>3</sup> / <sub>8</sub> "	± 9 mm	Matte R10 A

INDEX



PRODUCT  
FINDER



SURFACE  
RANGE



COMPANY



COLLECTIONS



- 3D WALL
- CONCRETE & RESIN LOOK
- METAL LOOK
- MARBLE LOOK
- STONE LOOK
- WOOD LOOK

LARGE SIZES



TECHNICAL  
SPECIFICATIONS



Coloured body porcelain tiles - Gres porcellanato colorato in massa - Grès cérame coloré dans la masse - Durchgefärbtes Feinsteinzeug - Gres porcelánico coloreado en masa - Керамический гранит окрашенный в массе  
Rectified monocaliber - Rettificato monocalibro - Rectifié mono-calibre - Geschliffen einkalbrig - Rectificado monocalibre - Ретифицированный в одном калибре

# Nid

## Porcelain Tiles

### MATTE SURFACE

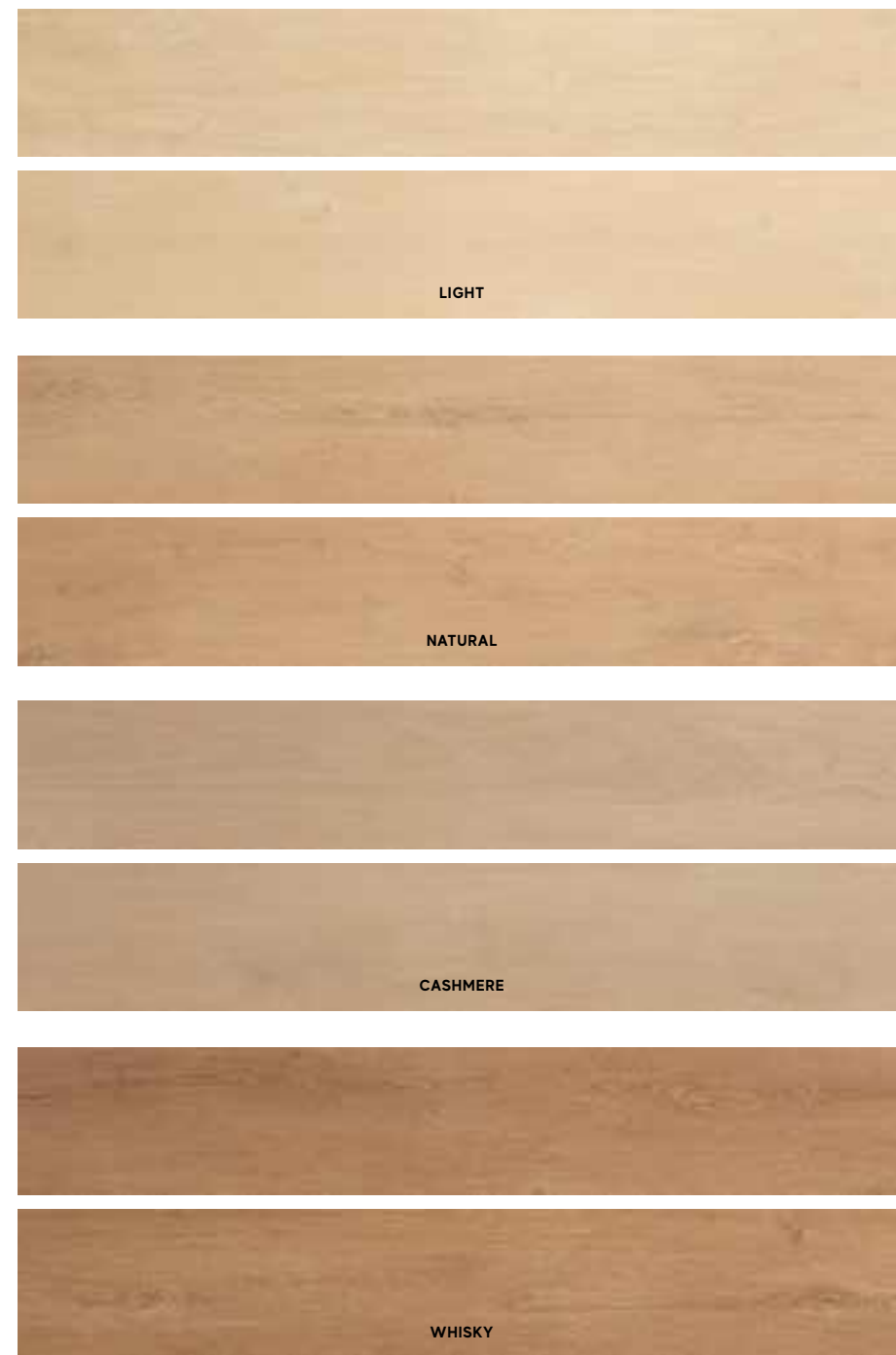

**± 9 mm**  
**25x150 cm - 9 7/8" x 59"**  
 AAL5 Nid Light  
 AAL6 Nid Natural  
 AKSU Nid Cashmere  
 AAL7 Nid Whisky

Matte surface - Superficie matt - Surface Mat - Matte Oberfläche - Superficie Mate - Матовая поверхность



### MATTE SURFACE

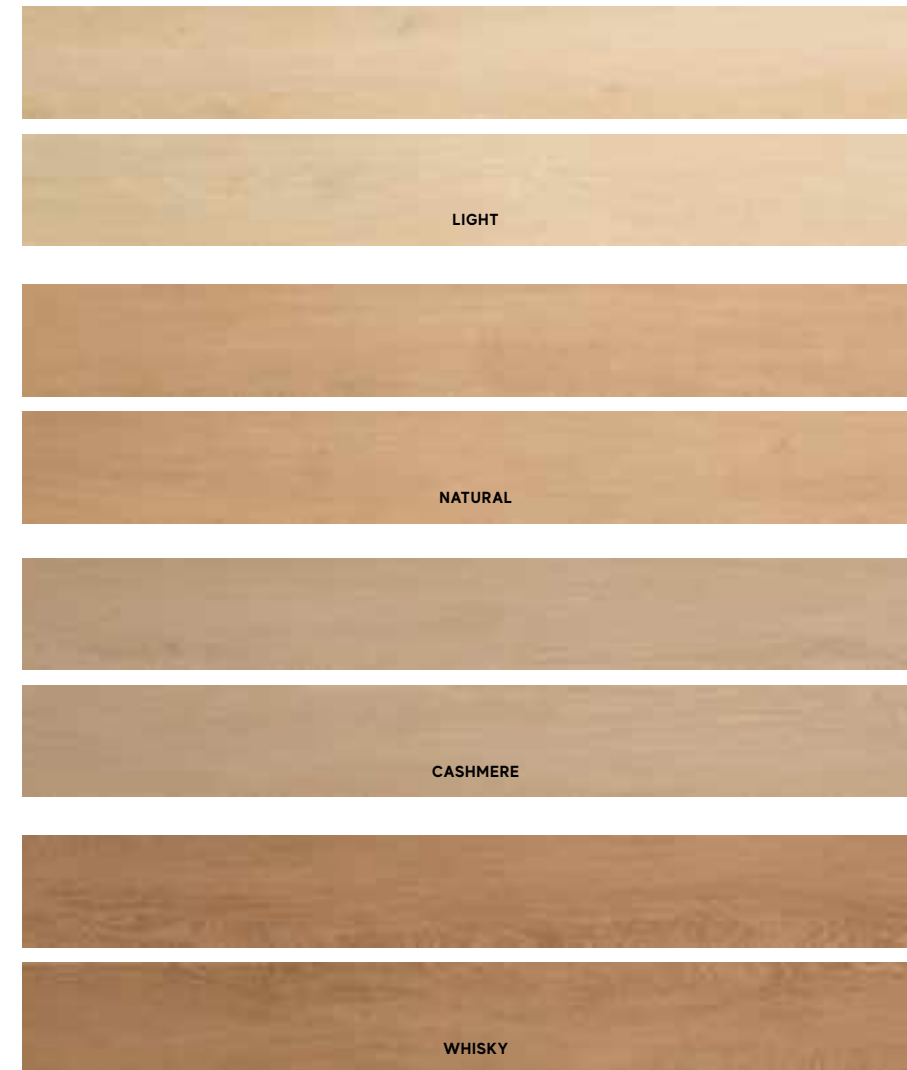



**± 9 mm**  
**18,5x150 cm - 7 1/4" x 59"**  
 AANK Nid Light  
 AANJ Nid Natural  
 AANI Nid Cashmere  
 AANL Nid Whisky

**± 9 mm**  
**15x90 cm - 5 7/8" x 35 3/8"**  
 D23Ø Nid Light  
 D231 Nid Natural  
 D233 Nid Cashmere  
 D232 Nid Whisky



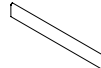

TRIM TILES  
 p. 462  
  
 p. 455

**Battiscopa**  
  
 7,2x90 cm  
 2 7/8" x 35 3/8"  
 Matt

**Scalino \***  
  
 33x150 cm  
 13" x 59"  
 Matt

**Scalin Ang.\***  
  
 33x33 cm  
 13" x 13"  
 Matt

**Battiscopa Sag. Scala \***  
  
 7,2x30 cm  
 2 7/8" x 1 1/4"  
 Matt

 Light	A8KF	A8KJ	A8KN	A8KR	A8KV	A8KZ
 Natural	A8KG	A8KK	A8KO	A8KS	A8KW	A8KØ
 Cashmere	A8KI	A8KM	A8KQ	A8KU	A8KY	A8K2
 Whisky	A8KH	A8KL	A8KP	A8KT	A8KX	A8K1

\* These parts are supplied to order - I pezzi sono disponibili su ordinazione - Les pièces sont disponibles sur commande - Die Teile sind auf Bestellung lieferbar - Las piezas se hacen por encargo - Изготавливаются на заказ

INDEX



PRODUCT  
 FINDER



SURFACE  
 RANGE



COMPANY



COLLECTIONS



- 3D WALL
- CONCRETE & RESIN LOOK
- METAL LOOK
- MARBLE LOOK
- STONE LOOK
- WOOD LOOK

LARGE SIZES



TECHNICAL  
 SPECIFICATIONS



# Nid

## Porcelain Tiles

### DECOR RANGE



AAOA Nid Light  
Mosaico Esagono  
30x35 - 11<sup>1</sup>/<sub>4</sub>"x13<sup>3</sup>/<sub>4</sub>"



AAOD Nid Cashmere  
Mosaico Esagono  
30x35 - 11<sup>1</sup>/<sub>4</sub>"x13<sup>3</sup>/<sub>4</sub>"



AAOB Nid Natural  
Mosaico Esagono  
30x35 - 11<sup>1</sup>/<sub>4</sub>"x13<sup>3</sup>/<sub>4</sub>"



AAOC Nid Whisky  
Mosaico Esagono  
30x35 - 11<sup>1</sup>/<sub>4</sub>"x13<sup>3</sup>/<sub>4</sub>"

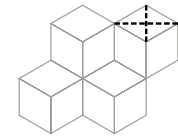

10x17 cm  
3<sup>7</sup>/<sub>8</sub>"x6<sup>3</sup>/<sub>4</sub>"



AAN6 Nid Light  
Herringbone  
36,2x41,2 - 14<sup>1</sup>/<sub>8</sub>"x16<sup>1</sup>/<sub>8</sub>"



AAN9 Nid Cashmere  
Herringbone  
36,2x41,2 - 14<sup>1</sup>/<sub>8</sub>"x16<sup>1</sup>/<sub>8</sub>"



AAN7 Nid Natural  
Herringbone  
36,2x41,2 - 14<sup>1</sup>/<sub>8</sub>"x16<sup>1</sup>/<sub>8</sub>"



AAN8 Nid Whisky  
Herringbone  
36,2x41,2 - 14<sup>1</sup>/<sub>8</sub>"x16<sup>1</sup>/<sub>8</sub>"

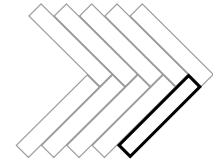

4,9x29 cm  
1<sup>7</sup>/<sub>8</sub>"x11<sup>1</sup>/<sub>8</sub>"



AAOO Nid Light  
Mosaico Intreccio  
35x35 - 13<sup>3</sup>/<sub>4</sub>"x13<sup>3</sup>/<sub>4</sub>"



AAOR Nid Cashmere  
Mosaico Intreccio  
35x35 - 13<sup>3</sup>/<sub>4</sub>"x13<sup>3</sup>/<sub>4</sub>"



AAOP Nid Natural  
Mosaico Intreccio  
35x35 - 13<sup>3</sup>/<sub>4</sub>"x13<sup>3</sup>/<sub>4</sub>"



AAOQ Nid Whisky  
Mosaico Intreccio  
35x35 - 13<sup>3</sup>/<sub>4</sub>"x13<sup>3</sup>/<sub>4</sub>"

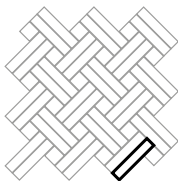

2,3x11,5 cm  
7<sup>7</sup>/<sub>8</sub>"x4<sup>1</sup>/<sub>2</sub>"



AANX Nid Light  
Tatami  
22,5x90 - 8<sup>7</sup>/<sub>8</sub>"x35<sup>3</sup>/<sub>8</sub>"



AAN1 Nid Cashmere  
Tatami  
22,5x90 - 8<sup>7</sup>/<sub>8</sub>"x35<sup>3</sup>/<sub>8</sub>"



AANY Nid Natural  
Tatami  
22,5x90 - 8<sup>7</sup>/<sub>8</sub>"x35<sup>3</sup>/<sub>8</sub>"



AANØ Nid Whisky  
Tatami  
22,5x90 - 8<sup>7</sup>/<sub>8</sub>"x35<sup>3</sup>/<sub>8</sub>"



2,3x90 cm  
7<sup>7</sup>/<sub>8</sub>"x35<sup>3</sup>/<sub>8</sub>"



AAN2 Nid Light  
Chevron  
11,5x67 - 4<sup>1</sup>/<sub>2</sub>"x26<sup>3</sup>/<sub>8</sub>"



AAN3 Nid Natural  
Chevron  
11,5x67 - 4<sup>1</sup>/<sub>2</sub>"x26<sup>3</sup>/<sub>8</sub>"



AAN5 Nid Cashmere  
Chevron  
11,5x67 - 4<sup>1</sup>/<sub>2</sub>"x26<sup>3</sup>/<sub>8</sub>"



AAN4 Nid Whisky  
Chevron  
11,5x67 - 4<sup>1</sup>/<sub>2</sub>"x26<sup>3</sup>/<sub>8</sub>"

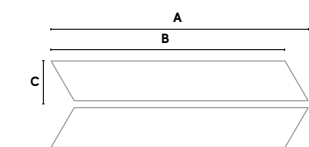

A 11,5 cm - 4<sup>1</sup>/<sub>2</sub>"  
B 73,6 cm - 29"  
C 67 cm - 26<sup>3</sup>/<sub>8</sub>"

INDEX



PRODUCT  
FINDER



SURFACE  
RANGE



COMPANY



COLLECTIONS



- 3D WALL
- CONCRETE & RESIN LOOK
- METAL LOOK
- MARBLE LOOK
- STONE LOOK
- WOOD LOOK

LARGE SIZES



TECHNICAL  
SPECIFICATIONS



# Groundtrack

## Technical Porcelain Tiles

### MATTE SURFACE



MT69 GT Yellow TURN  
30x30 - 11<sup>1</sup>/<sub>4</sub>"x11<sup>1</sup>/<sub>4</sub>"

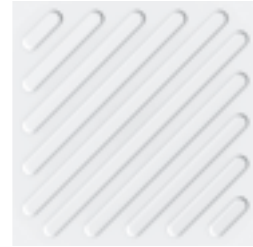

MT65 GT White TURN  
30x30 - 11<sup>1</sup>/<sub>4</sub>"x11<sup>1</sup>/<sub>4</sub>"



MT73 GT Black TURN  
30x30 - 11<sup>1</sup>/<sub>4</sub>"x11<sup>1</sup>/<sub>4</sub>"

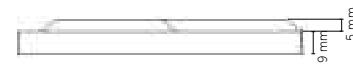

MT7Ø GT Yellow CROSS  
30x30 - 11<sup>1</sup>/<sub>4</sub>"x11<sup>1</sup>/<sub>4</sub>"

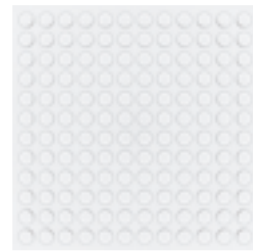

MT62 GT White CROSS  
30x30 - 11<sup>1</sup>/<sub>4</sub>"x11<sup>1</sup>/<sub>4</sub>"



MT74 GT Black CROSS  
30x30 - 11<sup>1</sup>/<sub>4</sub>"x11<sup>1</sup>/<sub>4</sub>"

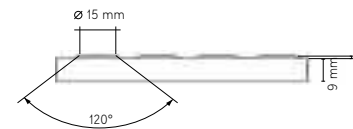

## Technical Porcelain Tiles

### MATTE SURFACE

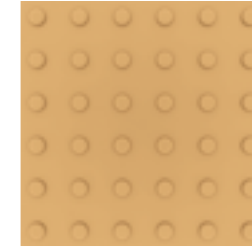

MT68 GT Yellow STOP  
30x30 - 11<sup>1</sup>/<sub>4</sub>"x11<sup>1</sup>/<sub>4</sub>"

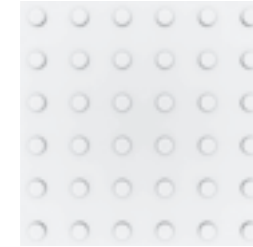

MT64 GT White STOP  
30x30 - 11<sup>1</sup>/<sub>4</sub>"x11<sup>1</sup>/<sub>4</sub>"

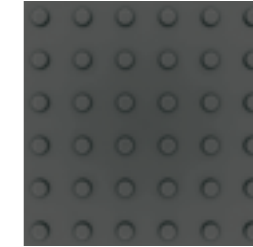

MT72 GT Black STOP  
30x30 - 11<sup>1</sup>/<sub>4</sub>"x11<sup>1</sup>/<sub>4</sub>"

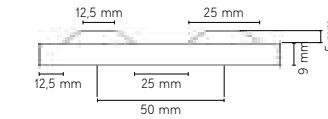

MT67 GT Yellow GO  
30x30 - 11<sup>1</sup>/<sub>4</sub>"x11<sup>1</sup>/<sub>4</sub>"



MT63 GT White GO  
30x30 - 11<sup>1</sup>/<sub>4</sub>"x11<sup>1</sup>/<sub>4</sub>"



MT71 GT Black GO  
30x30 - 11<sup>1</sup>/<sub>4</sub>"x11<sup>1</sup>/<sub>4</sub>"

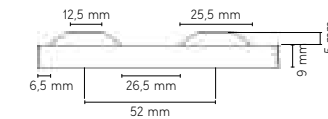

INDEX



PRODUCT  
FINDER



SURFACE  
RANGE



COMPANY



COLLECTIONS



- 3D WALL
- CONCRETE & RESIN LOOK
- METAL LOOK
- MARBLE LOOK
- STONE LOOK
- WOOD LOOK

LARGE SIZES



TECHNICAL  
SPECIFICATIONS



Technical porcelain tiles - Gres porcellanato tecnico - Grés cérame technique - Technisches Feinsteinzeug - Gres porcelánico técnico - Технический керамический гранит  
Matte surface - Superficie matt - Surface Mat - Matte Oberfläche - Superficie Mate - Матовая поверхность.



© Ceramiche Atlas Concorde

# Large Sizes

- 396 MARBLE LOOK
- 408 METAL LOOK
- 409 CONCRETE LOOK
- 418 STONE LOOK
- 427 SOLID LOOK
- 428 COLOR & DECOR LOOK

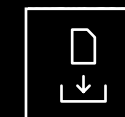

DOWNLOAD >  
LARGE SIZES CATALOG

INDEX 

PRODUCT  
FINDER >

SURFACE  
RANGE >

COMPANY >

COLLECTIONS >

LARGE SIZES >

TECHNICAL  
SPECIFICATIONS >

# Large Sizes

INDEX



Large Sizes Marble Look						Large Sizes Concrete Look					
<b>CARRARA PURE</b> MARVEL STONE MATTE, POLISHED	<b>CALACATTA EXTRA</b> MARVEL MATTE, POLISHED, SILK	<b>STATUARIO SELECT</b> MARVEL PRO POLISHED	<b>STATUARIO SUPREMO</b> MARVEL SHINE MATTE, POLISHED, SILK, SATIN	<b>CALACATTA DELICATO</b> MARVEL SHINE MATTE, POLISHED, SILK		<b>COTTON</b> PRISM MATTE, SILK	<b>OFF WHITE</b> DWELL MATTE	<b>WHITE</b> RAW MATTE	<b>WHITE</b> BOOST MATTE, HAMMERED	<b>PEARL</b> RAW MATTE	
<b>CALACATTA PRESTIGIO</b> MARVEL SHINE MATTE, POLISHED, SILK	<b>CALACATTA IMPERIALE</b> MARVEL SHINE MATTE, POLISHED, SILK, SATIN	<b>BIANCO DOLOMITE</b> MARVEL STONE MATTE, POLISHED	<b>CREMO DELICATO</b> MARVEL PRO MATTE, POLISHED	<b>CALACATTA BORGHINI</b> MARVEL POLISHED	<b>ROYAL CALACATTA</b> MARVEL EDGE POLISHED	<b>CLOUD</b> PRISM MATTE, SILK	<b>PEARL</b> BOOST MATTE	<b>GREY</b> BOOST MATTE, HAMMERED	<b>GRAY</b> DWELL MATTE	<b>FOG</b> PRISM MATTE, SILK	<b>SMOKE</b> BOOST MATTE, HAMMERED
<b>BIANCO FANTASTICO</b> MARVEL DREAM MATTE, POLISHED	<b>CALACATTA ANTIQUE</b> POLISHED	<b>CREAM PRESTIGE</b> MARVEL STONE POLISHED	<b>TRAVERTINO SAND</b> HAMMERED	<b>ELEGANT SABLE</b> MARVEL EDGE POLISHED	<b>IMPERIAL WHITE</b> MARVEL EDGE MATTE, POLISHED	<b>COAL</b> BOOST NATURAL MATTE	<b>SMOKE</b> DWELL MATTE	<b>TARMAC</b> BOOST MATTE, HAMMERED	<b>GRAPHITE</b> PRISM MATTE, SILK	<b>IVORY</b> BOOST PRO MATTE	<b>KAOLIN</b> BOOST NATURAL MATTE
<b>WHITE CLOUD</b> SILK	<b>LIGHT GREY STONE</b> SILK	<b>GRIS SUPREME</b> MARVEL EDGE POLISHED	<b>GREY FLEURY</b> MARVEL PRO MATTE, POLISHED	<b>GREY STONE</b> MARVEL MATTE, POLISHED, SILK	<b>GRIGIO INTENSO</b> MARVEL DREAM POLISHED, SILK	<b>CORD</b> PRISM MATTE, SILK	<b>ASH</b> BOOST NATURAL MATTE	<b>CREAM</b> BOOST PRO MATTE	<b>SAND</b> RAW MATTE	<b>CLAY</b> BOOST PRO MATTE	<b>CORAL</b> BOOST NATURAL MATTE
<b>ABSOLUTE BROWN</b> MARVEL EDGE POLISHED	<b>BLACK ATLANTIS</b> MARVEL DREAM MATTE, POLISHED	<b>NERO MARQUINA</b> MARVEL STONE MATTE, POLISHED, SILK, SATIN	<b>ULTRAMARINE</b> MARVEL DREAM POLISHED			<b>ECRU</b> BOOST NATURAL MATTE, HAMMERED	<b>GREIGE</b> DWELL MATTE	<b>TAUPE</b> BOOST PRO MATTE	<b>SUEDE</b> PRISM MATTE, SILK	<b>MUD</b> RAW MATTE	<b>UMBER</b> BOOST NATURAL MATTE
						<b>TOBACCO</b> BOOST PRO MATTE					

Large sizes Range — MARBLE LOOK

Large sizes Range — CONCRETE LOOK

PRODUCT  
FINDER



SURFACE  
RANGE



COMPANY



COLLECTIONS



LARGE SIZES



TECHNICAL  
SPECIFICATIONS



# Large Sizes

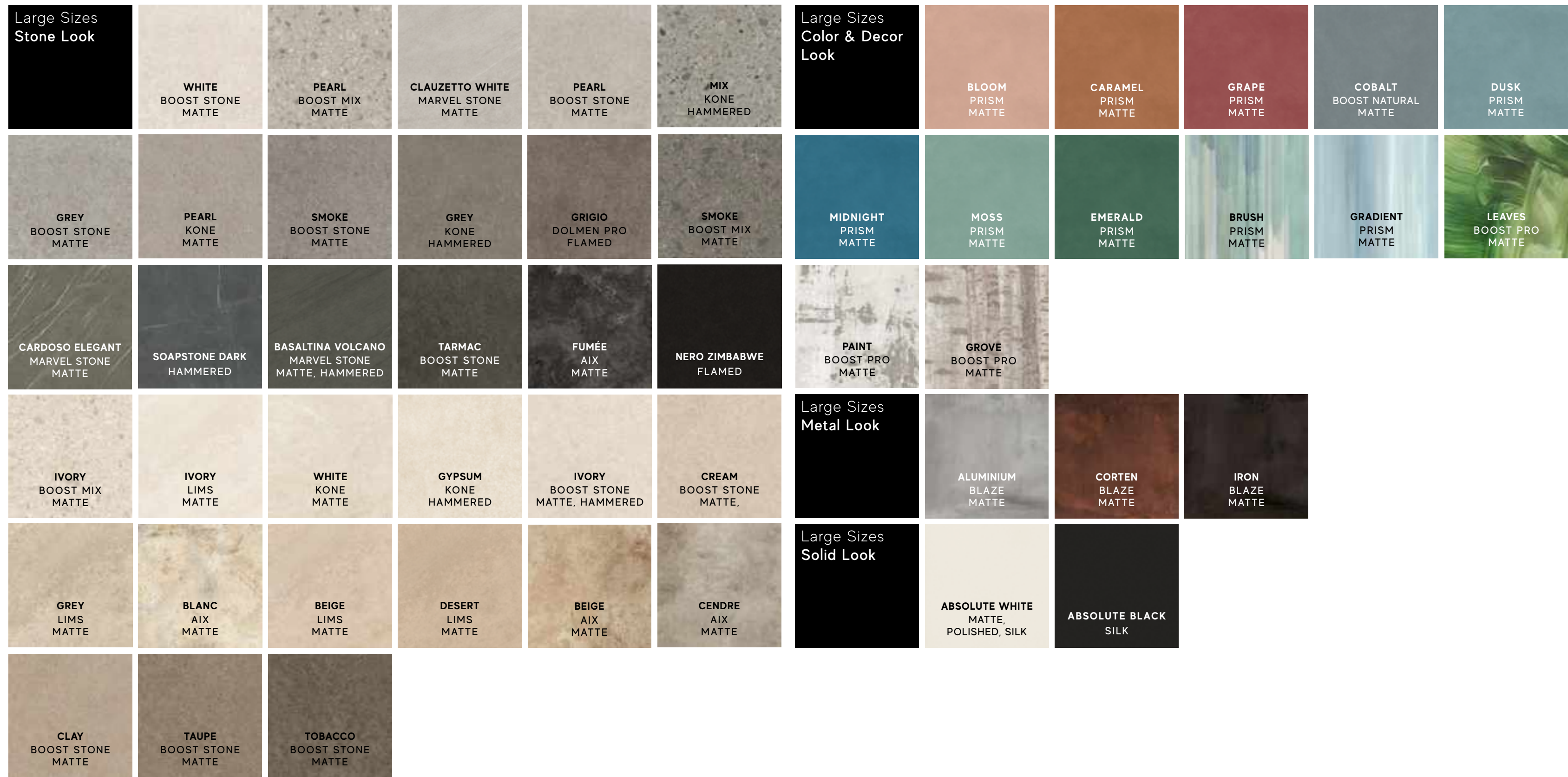

Large sizes Range — STONE LOOK

Large sizes Range — COLOR&DECOR, METAL, SOLID LOOK

INDEX



PRODUCT FINDER



SURFACE RANGE



COMPANY



COLLECTIONS



LARGE SIZES



TECHNICAL SPECIFICATIONS



# Large Sizes

## Porcelain Tiles



MARVEL SHINE  
CALACATTA DELICATO

Sizes	Thickness	Surface finish
120x120 cm - 47 <sup>1</sup> / <sub>4</sub> "x47 <sup>1</sup> / <sub>4</sub> "	± 9 mm	Polished I Matte
120x240 cm - 47 <sup>1</sup> / <sub>4</sub> "x94 <sup>1</sup> / <sub>2</sub> "	± 9 mm	Polished
120x278 cm - 47 <sup>1</sup> / <sub>4</sub> "x109 <sup>1</sup> / <sub>2</sub> "	± 6 mm	Polished
162x324 cm - 63 <sup>3</sup> / <sub>4</sub> "x127 <sup>1</sup> / <sub>2</sub> "	± 12 mm	Silk

- A4Q4 Marvel Calacatta Delicato 120x120 Matt
- A4Q8 Marvel Calacatta Delicato 120x120 Lappato
- A4RH Marvel Calacatta Delicato 120x240 Lappato
- A4OY Marvel Calacatta Delicato 120x278 Lappato

atlasPLAN SINGLE SLAB NON RECTIFIED  
162x324 cm - 63<sup>3</sup>/<sub>4</sub>"x127<sup>1</sup>/<sub>2</sub>"

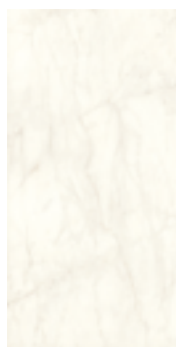

A4T3 Calacatta Delicato Silk - 12 mm ST \*

◆ The various graphics of the product are distributed randomly in the boxes, without the possibility of choosing between the available patterns.  
 ■ The Endless Kit contains all the graphics of the product with vein continuity, ensuring that all the numbered faces in the composition can be found in a single box. The number of the graphic - G1, G2, G3, etc - is printed on the side and indicated with an adhesive label placed on the slab. To reconstruct the surface with continuous veins, simply lay the tiles in numerical progression: G1, G2, G3 and so on.  
 ▲ Minor misalignments in the continuity of the veins between different graphics is normal for this type of product.  
 ✕ With fiberglass mesh

(translations: page 433)

## Marble Look



MARVEL SHINE  
CALACATTA PRESTIGIO

Sizes	Thickness	Surface finish
120x120 cm - 47 <sup>1</sup> / <sub>4</sub> "x47 <sup>1</sup> / <sub>4</sub> "	± 9 mm	Polished I Matte
120x240 cm - 47 <sup>1</sup> / <sub>4</sub> "x94 <sup>1</sup> / <sub>2</sub> "	± 9 mm	Polished
120x278 cm - 47 <sup>1</sup> / <sub>4</sub> "x109 <sup>1</sup> / <sub>2</sub> "	± 6 mm	Polished I Silk
160x160 cm - 63"x63"	± 6 mm	Polished
160x320 cm - 63"x126"	± 6 mm	Polished
162x324 cm - 63 <sup>3</sup> / <sub>4</sub> "x127 <sup>1</sup> / <sub>2</sub> "	± 12 mm	Silk

- A4Q5 Marvel Calacatta Prestigio 120x120 Matt
- A4Q9 Marvel Calacatta Prestigio 120x120 Lappato
- A4RI Marvel Calacatta Prestigio 120x240 Lappato
- A4OZ Marvel Calacatta Prestigio 120x278 Lappato
- A4O6 Marvel Calacatta Prestigio 120x278 Silk
- A4RP Marvel Calacatta Prestigio 160x160 Lappato
- A4RR Marvel Calacatta Prestigio 160x320 Lappato

BOOKMATCH A ▲ BOOKMATCH B ▲



120x278 cm - 47<sup>1</sup>/<sub>4</sub>"x109<sup>1</sup>/<sub>2</sub>" ± 6 mm Polished

- A4O2 Marvel Calacatta Prestigio 120x278 Lappato Bookmatch A
- A4O3 Marvel Calacatta Prestigio 120x278 Lappato Bookmatch B

KIT ENDLESS ■ ▲

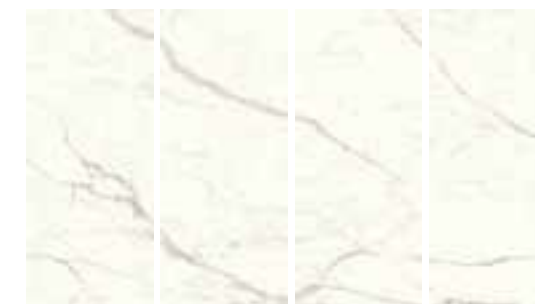

160x320 cm - 63"x126" ± 6 mm Polished  
 120x278 cm - 47<sup>1</sup>/<sub>4</sub>"x109<sup>1</sup>/<sub>2</sub>" ± 6 mm Polished I Silk

- A6EO Marvel Calacatta Prestigio 120x278 Lappato Kit Endless
- A6ER Marvel Calacatta Prestigio 120x278 Silk Kit Endless

atlasPLAN SINGLE SLAB NON RECTIFIED  
162x324 cm - 63<sup>3</sup>/<sub>4</sub>"x127<sup>1</sup>/<sub>2</sub>"

CALACATTA PRESTIGIO CALACATTA PRESTIGIO BOOKMATCH

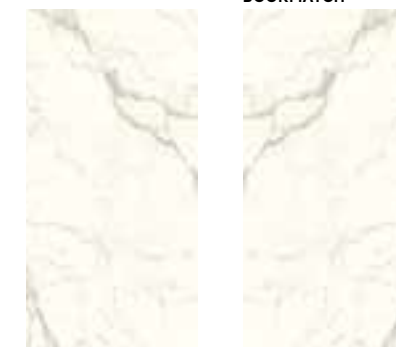

A4TØ Calacatta Prestigio Silk - 12 mm ST \*  
 A4T1 Calacatta Prestigio Bookmatch Silk - 12 mm ST \*

INDEX



PRODUCT  
FINDER



SURFACE  
RANGE



COMPANY



COLLECTIONS



LARGE SIZES



TECHNICAL  
SPECIFICATIONS





# Large Sizes

## Porcelain Tiles



Sizes	Thickness	Surface finish
120x120 cm - 47 1/4" x 47 1/4"	± 9 mm	Polished   Matte
120x240 cm - 47 1/4" x 94 1/2"	± 9 mm	Polished
120x278 cm - 47 1/4" x 109 1/2"	± 6 mm	Polished   Silk
160x160 cm - 63" x 63"	± 6 mm	Polished
160x320 cm - 63" x 126"	± 6 mm	Polished
162x324 cm - 63 3/4" x 127 1/2"	± 12 mm	Silk   Satin
162x324 cm - 63 3/4" x 127 1/2" NON RECTIFIED	± 20 mm	Polished   Silk

- A4Q6 Marvel Statuario Supremo 120x120 Matt
- A4RA Marvel Statuario Supremo 120x120 Lappato
- A4RJ Marvel Statuario Supremo 120x240 Lappato
- A4OØ Marvel Statuario Supremo 120x278 Lappato
- A4O7 Marvel Statuario Supremo 120x278 Silk
- A4RQ Marvel Statuario Supremo 160x160 Lappato
- A4RS Marvel Statuario Supremo 160x320 Lappato

### BOOKMATCH A ▲ BOOKMATCH B ▲



120x278 cm - 47 1/4" x 109 1/2" ± 6 mm Polished

- A4O4 Marvel Statuario Supremo 120x278 Lappato Bookmatch A
- A4O5 Marvel Statuario Supremo 120x278 Lappato Bookmatch B

### KIT ENDLESS ■ ▲

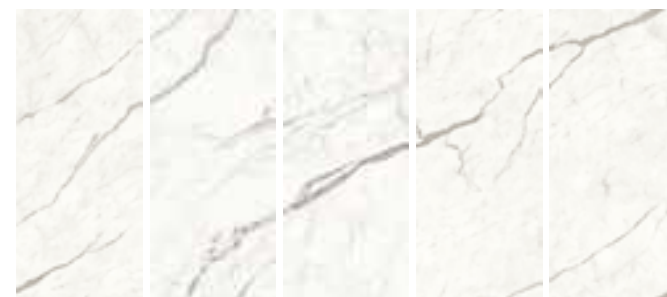

160x320 cm - 63" x 126" ± 6 mm Polished

120x278 cm - 47 1/4" x 109 1/2" ± 6 mm Polished | Silk

- A6EP Marvel Statuario Supremo 120x278 Lappato Kit Endless
- A6ES Marvel Statuario Supremo 120x278 Silk Kit Endless

**atlasPLAN** SINGLE SLAB NON RECTIFIED  
162x324 cm - 63 3/4" x 127 1/2"

STATUARIO SUPREMO	STATUARIO SUPREMO BOOKMATCH	STATUARIO SUPREMO NATURA VEIN

- A4I3 Statuario Supremo Satin - 12 mm ST \*
- A4TX Statuario Supremo Silk - 12 mm ST \*
- A4I5 Statuario Supremo Bookmatch Satin - 12 mm ST \*
- A4TY Statuario Supremo Bookmatch Silk - 12 mm ST \*
- A3VR Statuario Supremo Polished NATURA VEIN - 20 mm
- A3VQ Statuario Supremo Silk NATURA VEIN - 20 mm

◆ The various graphics of the product are distributed randomly in the boxes, without the possibility of choosing between the available patterns.  
 ■ The Endless Kit contains all the graphics of the product with vein continuity, ensuring that all the numbered faces in the composition can be found in a single box. The number of the graphic - G1, G2, G3, etc - is printed on the side and indicated with an adhesive label placed on the slab. To reconstruct the surface with continuous veins, simply lay the tiles in numerical progression: G1, G2, G3 and so on.  
 ▲ Minor misalignments in the continuity of the veins between different graphics is normal for this type of product.  
 ✖ With fiberglass mesh

(translations: page 433)

# Marble Look

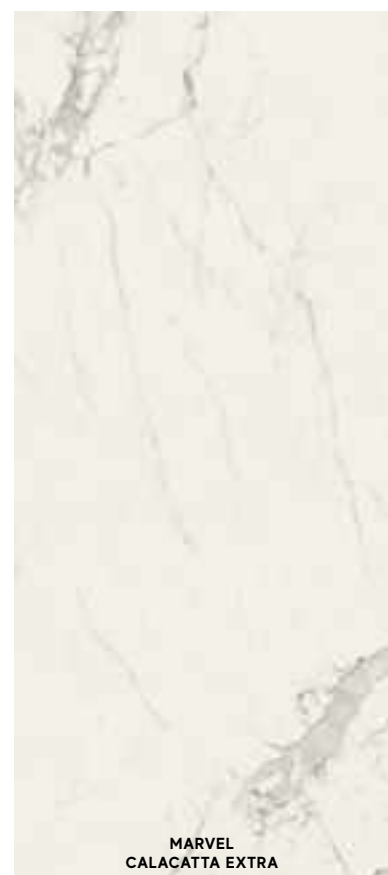

Sizes	Thickness	Surface finish
120x120 cm - 47 1/4" x 47 1/4"	± 9 mm	Polished   Matte
120x240 cm - 47 1/4" x 94 1/2"	± 9 mm	Polished
120x278 cm - 47 1/4" x 109 1/2"	± 6 mm	Polished   Matte
160x160 cm - 63" x 63"	± 6 mm	Polished   Matte
160x320 cm - 63" x 126"	± 6 mm	Polished   Matte
162x324 cm - 63 3/4" x 127 1/2" NON RECTIFIED	± 6-12-20 mm	Polished   Silk

- A2ØY Marvel Calacatta Extra 120x120 Matt
- AY2R Marvel Calacatta Extra 120x120 Lappato
- AY2N Marvel Calacatta Extra 120x240 Lappato
- AØBT Marvel Calacatta Extra 120x278 Matt
- AØBM Marvel Calacatta Extra 120x278 Lappato
- AO54 Marvel Calacatta Extra 160x160RT Matt
- AO51 Marvel Calacatta Extra 160x160RT Lappato
- AO5Y Marvel Calacatta Extra 160x320RT Matt
- AO5U Marvel Calacatta Extra 160x320RT Lappato

### BOOKMATCH A ▲ BOOKMATCH B ▲



120x278 cm - 47 1/4" x 109 1/2" ± 6 mm Polished

- AOTJ Marvel Calacatta Extra 120x278 Lappato Bookmatch A
- AOTK Marvel Calacatta Extra 120x278 Lappato Bookmatch B

### KIT ENDLESS ■ ▲

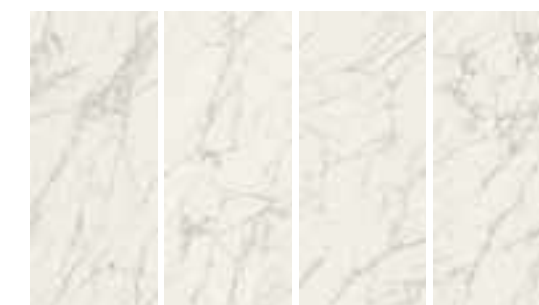

120x278 cm - 47 1/4" x 109 1/2" ± 6 mm Polished

- A6DU Marvel Calacatta Extra 120x278 Kit Endless Lappato

- AOUB Marvel Calacatta Extra 120x278 Endless Lappato

\* Calacatta Extra Endless is composed of four graphics with vein continuity, but are distributed randomly in the boxes, without the possibility of choosing between the available patterns. (SEE PAGE 433)

**atlasPLAN** SINGLE SLAB NON RECTIFIED  
162x324 cm - 63 3/4" x 127 1/2"

CALACATTA EXTRA A	CALACATTA EXTRA A BOOKMATCH	CALACATTA EXTRA A NATURA VEIN	CALACATTA EXTRA B

- AN1J C. Extra A Polished - 6 mm ST \*
- AN1G C. Extra A Silk - 6 mm ST \*
- AAVD C. Extra A Polished - 12 mm ST \*
- AA2T C. Extra A Silk - 12 mm ST \*
- AN1W C. Extra A Polished - 20 mm
- AØYC C. Extra A Silk - 20 mm
- AOAZ C. Extra A Bookmatch Polished - 6 mm ST \*
- AOAW C. Extra A Bookmatch Silk - 6 mm ST \*
- AA2X C. Extra A Bookmatch Polished - 12 mm ST \*
- AMJV C. Extra A Bookmatch Silk - 12 mm ST \*

- AØYD C. Extra A Bookmatch Silk - 20 mm
- A3VS C. Extra A Bookmatch Polished - 20 mm
- AOOI C. Extra B Polished - 6 mm ST \*
- AOOK C. Extra B Silk - 6 mm ST \*
- AAVF C. Extra B Polished - 12 mm ST \*
- AA3G C. Extra B Silk - 12 mm ST \*
- AOOE C. Extra B Polished - 20 mm
- A3M3 C. Extra A Polished NATURA VEIN - 20 mm
- A28Q C. Extra A Silk NATURA VEIN - 20 mm

INDEX



PRODUCT FINDER



SURFACE RANGE



COMPANY



COLLECTIONS



LARGE SIZES



TECHNICAL SPECIFICATIONS



# Large Sizes

## Porcelain Tiles



Sizes	Thickness	Surface finish
120x120 cm - 47 <sup>1</sup> / <sub>4</sub> "x47 <sup>1</sup> / <sub>4</sub> "	± 9 mm	Polished   Matte
120x240 cm - 47 <sup>1</sup> / <sub>4</sub> "x94 <sup>1</sup> / <sub>2</sub> "	± 9 mm	Polished
120x278 cm - 47 <sup>1</sup> / <sub>4</sub> "x109 <sup>1</sup> / <sub>2</sub> "	± 6 mm	Polished
162x324 cm - 63 <sup>3</sup> / <sub>4</sub> "x127 <sup>1</sup> / <sub>2</sub> "	± 6 mm	Silk
162x324 cm - 63 <sup>3</sup> / <sub>4</sub> "x127 <sup>1</sup> / <sub>2</sub> "	± 12 mm	Polished   Satin   Silk
162x324 cm - 63 <sup>3</sup> / <sub>4</sub> "x127 <sup>1</sup> / <sub>2</sub> "	± 20 mm	Polished   Silk

A4Q7 Marvel Calacatta Imperiale 120x120 Matt  
 A4RB Marvel Calacatta Imperiale 120x120 Lappato  
 A4RK Marvel Calacatta Imperiale 120x240 Lappato  
 A4O1 Marvel Calacatta Imperiale 120x278 Lappato

KIT ENDLESS ■ ▲



120x278 cm - 47<sup>1</sup>/<sub>4</sub>"x109<sup>1</sup>/<sub>2</sub>" ± 6 mm Polished

A6EQ Marvel Calacatta Imperiale 120x278 Lappato Kit Endless

atlasPLAN SINGLE SLAB NON RECTIFIED  
 162x324 cm - 63<sup>3</sup>/<sub>4</sub>"x127<sup>1</sup>/<sub>2</sub>"

CALACATTA IMPERIALE CALACATTA IMPERIALE BOOKMATCH CALACATTA IMPERIALE NATURA VEIN

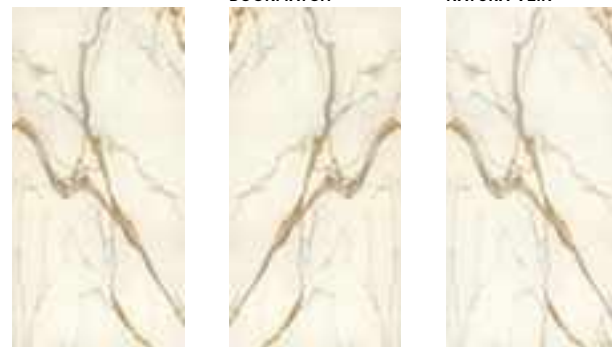

A2YG Calacatta Imp. Silk - 6 mm ST \*  
 A2YH Calacatta Imp. Bookmatch Silk - 6 mm ST \*  
 AØXI Calacatta Imp. Polished - 12 mm ST \*  
 AØXT Calacatta Imp. Bookmatch Polished - 12 mm ST \*  
 A3M9 Calacatta Imp. Satin - 12 mm ST \*

A4I1 Calacatta Imp. Bookmatch Satin - 12 mm ST \*  
 AØXV Calacatta Imp. Silk - 12 mm ST \*  
 AØXX Calacatta Imp. Bookmatch Silk - 12 mm ST \*  
 A1AE Calacatta Imp. Polished NATURA VEIN - 20 mm  
 A16W Calacatta Imp. Silk NATURA VEIN - 20 mm

◆ The various graphics of the product are distributed randomly in the boxes, without the possibility of choosing between the available patterns.

■ The Endless Kit contains all the graphics of the product with vein continuity, ensuring that all the numbered faces in the composition can be found in a single box. The number of the graphic - G1, G2, G3, etc - is printed on the side and indicated with an adhesive label placed on the slab. To reconstruct the surface with continuous veins, simply lay the tiles in numerical progression: G1, G2, G3 and so on.

▲ Minor misalignments in the continuity of the veins between different graphics is normal for this type of product.

\* With fiberglass mesh

(translations: page 433)

## Marble Look

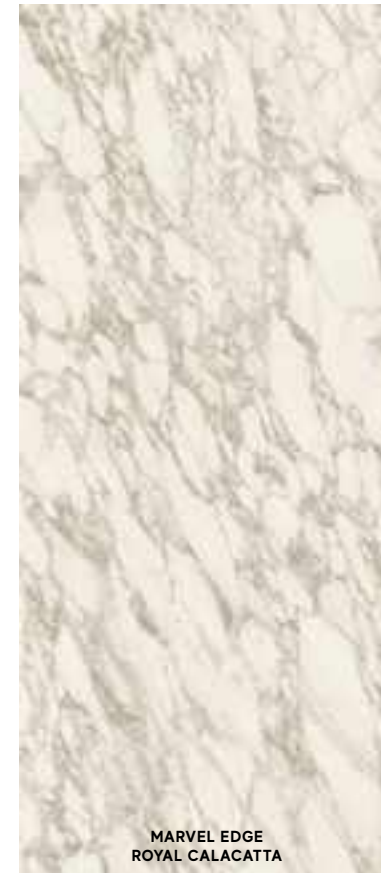

Sizes	Thickness	Surface finish
120x120 cm - 47 <sup>1</sup> / <sub>4</sub> "x47 <sup>1</sup> / <sub>4</sub> "	± 9 mm	Polished
120x240 cm - 47 <sup>1</sup> / <sub>4</sub> "x94 <sup>1</sup> / <sub>2</sub> "	± 9 mm	Polished
120x278 cm - 47 <sup>1</sup> / <sub>4</sub> "x109 <sup>1</sup> / <sub>2</sub> "	± 6 mm	Polished
162x324 cm - 63 <sup>3</sup> / <sub>4</sub> "x127 <sup>1</sup> / <sub>2</sub> "	± 12 mm	Polished

AENP Marvel Royal Calacatta 120x120 Lappato  
 AENU Marvel Royal Calacatta 120x240 Lappato  
 AØBH Marvel Royal Calacatta 120x278 Lappato

atlasPLAN SINGLE SLAB NON RECTIFIED  
 162x324 cm - 63<sup>3</sup>/<sub>4</sub>"x127<sup>1</sup>/<sub>2</sub>"

ROYAL CALACATTA ROYAL CALACATTA BOOKMATCH



AAI7 Calacatta Royal Polished - 12 mm ST \*  
 AA9M Calacatta Royal Bookmatch Polished - 12 mm ST \*



Sizes	Thickness	Surface finish
162x324 cm - 63 <sup>3</sup> / <sub>4</sub> "x127 <sup>1</sup> / <sub>2</sub> "	± 20 mm	Polished

NON RECTIFIED

atlasPLAN SINGLE SLAB NON RECTIFIED  
 162x324 cm - 63<sup>3</sup>/<sub>4</sub>"x127<sup>1</sup>/<sub>2</sub>"

A6OI Calacatta Borghini Polished NATURA VEIN - 20 mm ST \*

INDEX



PRODUCT FINDER



SURFACE RANGE



COMPANY



COLLECTIONS



LARGE SIZES



TECHNICAL SPECIFICATIONS



# Large Sizes

## Porcelain Tiles

### Marble Look



MARVEL DREAM  
BIANCO FANTASTICO

Sizes	Thickness	Surface finish
120x120 cm - 47 1/4" x 47 1/4"	± 9 mm	Polished   Matte
120x240 cm - 47 1/4" x 94 1/2"	± 9 mm	Polished
120x278 cm - 47 1/4" x 109 1/2"	± 6 mm	Polished   Matte

A2Ø3 Marvel Bianco Fantastico 120x120 Matt  
 AL7N Marvel Bianco Fantastico 120x120 Lappato  
 AO3P Marvel Bianco Fantastico 120x240 Lappato  
 A2RR Marvel Bianco Fantastico 120x278 Matt  
 AOSE Marvel Bianco Fantastico 120x278 Lappato



MARVEL PRO  
STATUARIO SELECT

Sizes	Thickness	Surface finish
120x120 cm - 47 1/4" x 47 1/4"	± 9 mm	Polished
120x240 cm - 47 1/4" x 94 1/2"	± 9 mm	Polished
120x278 cm - 47 1/4" x 109 1/2"	± 6 mm	Polished

AY2T Marvel Statuario Select 120x120 Lappato  
 AY2P Marvel Statuario Select 120x240 Lappato  
 AØBN Marvel Statuario Select 120x278 Lappato

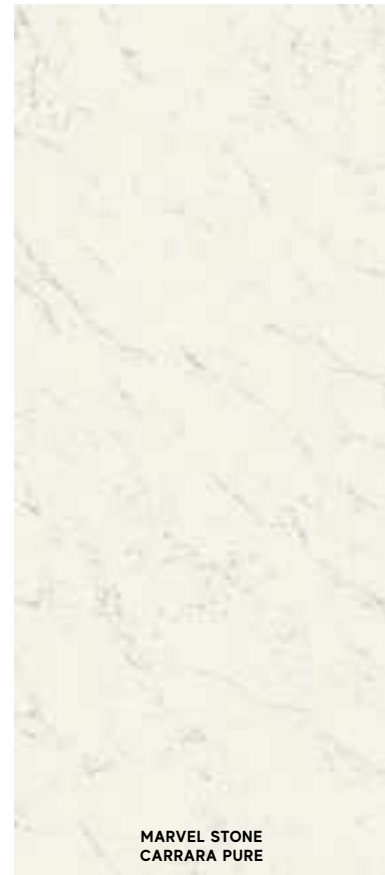

MARVEL STONE  
CARRARA PURE

Sizes	Thickness	Surface finish
120x120 cm - 47 1/4" x 47 1/4"	± 9 mm	Polished   Matte
120x240 cm - 47 1/4" x 94 1/2"	± 9 mm	Polished
120x278 cm - 47 1/4" x 109 1/2"	± 6 mm	Polished   Matte

A2Ø7 Marvel Carrara Pure 120x120 Matt  
 AZTU Marvel Carrara Pure 120x120 Lappato  
 AZTW Marvel Carrara Pure 120x240 Lappato  
 A2RV Marvel Carrara Pure 120x278 Matt  
 A2RW Marvel Carrara Pure 120x278 Lappato



MARVEL STONE  
BIANCO DOLOMITE

Sizes	Thickness	Surface finish
120x120 cm - 47 1/4" x 47 1/4"	± 9 mm	Polished   Matte
120x240 cm - 47 1/4" x 94 1/2"	± 9 mm	Polished
120x278 cm - 47 1/4" x 109 1/2"	± 6 mm	Polished   Matte
160x160 cm - 63" x 63"	± 6 mm	Polished
160x320 cm - 63" x 126"	± 6 mm	Polished
162x324 cm - 63 3/4" x 127 1/2"	± 12 mm	Polished NON RECTIFIED

A2Ø4 Marvel Bianco Dolomite 120x120 Matt  
 AZTT Marvel Bianco Dolomite 120x120 Lappato  
 AZTV Marvel Bianco Dolomite 120x240 Lappato  
 A2RS Marvel Bianco Dolomite 120x278 Matt  
 AØBP Marvel Bianco Dolomite 120x278 Lappato  
 AO53 Marvel Bianco Dolomite 160x160RT Lappato  
 AO5X Marvel Bianco Dolomite 160x320RT Lappato

atlasPLAN SINGLE SLAB NON RECTIFIED  
162x324 cm - 63 3/4" x 127 1/2"

AAVG Bianco Dolomite A Polished - 12 mm ST \*



MARVEL PRO  
CREMA DELICATO

Sizes	Thickness	Surface finish
120x120 cm - 47 1/4" x 47 1/4"	± 9 mm	Polished   Matte
120x240 cm - 47 1/4" x 94 1/2"	± 9 mm	Polished
120x278 cm - 47 1/4" x 109 1/2"	± 6 mm	Polished   Matte
160x160 cm - 63" x 63"	± 6 mm	Polished
160x320 cm - 63" x 126"	± 6 mm	Polished

A2Ø6 Marvel Crema Delicato 120x120 Matt  
 AY2U Marvel Crema Delicato 120x120 Lappato  
 AY2Q Marvel Crema Delicato 120x240 Lappato  
 A2RU Marvel Crema Delicato 120x278 Matt  
 AØBO Marvel Crema Delicato 120x278 Lappato  
 AO52 Marvel Crema Delicato 160x160RT Lappato  
 AO5W Marvel Crema Delicato 160x320RT Lappato

◆ The various graphics of the product are distributed randomly in the boxes, without the possibility of choosing between the available patterns.  
 ✖ With fiberglass mesh (translations: page 433)

# Large Sizes

## Porcelain Tiles

### Marble Look



MARVEL PRO  
GREY FLEURY

Sizes	Thickness	Surface finish
120x120 cm - 47 1/4" x 47 1/4"	± 9 mm	Polished I Matte
120x278 cm - 47 1/4" x 109 1/2"	± 6 mm	Polished I Matte

A2Ø5 Marvel Grey Fleury 120x120 Matt  
A21O Marvel Grey Fleury 120x120 Lappato  
A2RT Marvel Grey Fleury 120x278 Matt  
A2RX Marvel Grey Fleury 120x278 Lappato



MARVEL  
GREY STONE

Sizes	Thickness	Surface finish
120x120 cm - 47 1/4" x 47 1/4"	± 9 mm	Polished I Matte
120x240 cm - 47 1/4" x 94 1/2"	± 9 mm	Polished
120x278 cm - 47 1/4" x 109 1/2"	± 6 mm	Polished I Matte
162x324 cm - 63 3/4" x 127 1/2"	± 6-12-20 mm	Silk NON RECTIFIED

AEQY Marvel Grey Stone 120x120 Matt  
AY2S Marvel Grey Stone 120x120 Lappato  
AY2O Marvel Grey Stone 120x240 Lappato  
A2RP Marvel Grey Stone 120x278 Matt  
AOQD Marvel Grey Stone 120x278 Lappato

**atlasPLAN** SINGLE SLAB NON RECTIFIED  
162x324 cm - 63 3/4" x 127 1/2"

AN1V Grey Stone Silk - 6 mm ST \*  
AAWA Grey Stone Silk - 12 mm ST \*  
AN2B Grey Stone Silk - 20 mm



MARVEL DREAM  
GRIGIO INTENSO

Sizes	Thickness	Surface finish
120x120 cm - 47 1/4" x 47 1/4"	± 9 mm	Polished
120x240 cm - 47 1/4" x 94 1/2"	± 9 mm	Polished
120x278 cm - 47 1/4" x 109 1/2"	± 6 mm	Polished
162x324 cm - 63 3/4" x 127 1/2"	± 6 mm	Silk
NON RECTIFIED	± 12 mm	Polished

AL7O Marvel Grigio Intenso 120x120 Lappato  
AO3Q Marvel Grigio Intenso 120x240 Lappato  
AOSF Marvel Grigio Intenso 120x278 Lappato

**atlasPLAN** SINGLE SLAB NON RECTIFIED  
162x324 cm - 63 3/4" x 127 1/2"

A2Y1 Grigio Intenso Silk - 6 mm ST \*  
AL91 Grigio Intenso Polished - 12 mm ST \*



MARVEL EDGE  
ABSOLUTE BROWN

Sizes	Thickness	Surface finish
120x120 cm - 47 1/4" x 47 1/4"	± 9 mm	Polished
120x278 cm - 47 1/4" x 109 1/2"	± 6 mm	Polished

AENO Marvel Absolute Brown 120x120 Lappato  
AOQC Marvel Absolute Brown 120x278 Lappato



MARVEL DREAM  
BLACK ATLANTIS

Sizes	Thickness	Surface finish
120x120 cm - 47 1/4" x 47 1/4"	± 9 mm	Polished I Matte
120x240 cm - 47 1/4" x 94 1/2"	± 9 mm	Polished
120x278 cm - 47 1/4" x 109 1/2"	± 6 mm	Polished I Matte

A2ØZ Marvel Black Atlantis 120x120 Matt  
AL7P Marvel Black Atlantis 120x120 Lappato  
AO3R Marvel Black Atlantis 120x240 Lappato  
A2RQ Marvel Black Atlantis 120x278 Matt  
AOSG Marvel Black Atlantis 120x278 Lappato



MARVEL DREAM  
ULTRAMARINE

Sizes	Thickness	Surface finish
120x278 cm - 47 1/4" x 109 1/2"	± 6 mm	Polished

AL2I Marvel Ultramarine 120x278 Lappato\*  
\* Ultramarine 120x278 cm: Glazed Porcelain tiles

◆ The various graphics of the product are distributed randomly in the boxes, without the possibility of choosing between the available patterns.  
\* With fiberglass mesh

(SEE PAGE 433)

INDEX



PRODUCT  
FINDER



SURFACE  
RANGE



COMPANY



COLLECTIONS



LARGE SIZES



TECHNICAL  
SPECIFICATIONS



# Large Sizes

## Porcelain Tiles

### Marble Look



CALACATTA ANTIQUE

**Sizes** **Thickness** **Surface finish**  
**162x324 cm** - 63<sup>3</sup>/<sub>4</sub>"x127<sup>1</sup>/<sub>2</sub>" ± 12 mm Polished  
 NON RECTIFIED



MARVEL STONE  
CREAM PRESTIGE

**Sizes** **Thickness** **Surface finish**  
**162x324 cm** - 63<sup>3</sup>/<sub>4</sub>"x127<sup>1</sup>/<sub>2</sub>" ± 12 mm Silk  
 NON RECTIFIED



TRAVERTINO SAND

**Sizes** **Thickness** **Surface finish**  
**162x324 cm** - 63<sup>3</sup>/<sub>4</sub>"x127<sup>1</sup>/<sub>2</sub>" ± 12 mm Hammered  
 NON RECTIFIED



WHITE CLOUD

**Sizes** **Thickness** **Surface finish**  
**162x324 cm** - 63<sup>3</sup>/<sub>4</sub>"x127<sup>1</sup>/<sub>2</sub>" ± 12 mm Silk  
 NON RECTIFIED



LIGHT GREY  
STONE

**Sizes** **Thickness** **Surface finish**  
**162x324 cm** - 63<sup>3</sup>/<sub>4</sub>"x127<sup>1</sup>/<sub>2</sub>" ± 12 mm Silk  
 NON RECTIFIED



MARVEL STONE  
NERO MARQUINA

**Sizes** **Thickness** **Surface finish**  
**162x324 cm** - 63<sup>3</sup>/<sub>4</sub>"x127<sup>1</sup>/<sub>2</sub>" ± 6 mm Silk  
 NON RECTIFIED  
 ± 12 mm Polished | Silk | Satin  
 ± 20 mm Silk

**atlasPLAN** SINGLE SLAB NON RECTIFIED  
 162x324 cm - 63<sup>3</sup>/<sub>4</sub>"x127<sup>1</sup>/<sub>2</sub>"

A0XZ Calacatta Antique Polished - 12 mm ST \*

**atlasPLAN** SINGLE SLAB NON RECTIFIED  
 162x324 cm - 63<sup>3</sup>/<sub>4</sub>"x127<sup>1</sup>/<sub>2</sub>"

AAV6 Cream Prestige Silk - 12 mm ST \*

**atlasPLAN** SINGLE SLAB NON RECTIFIED  
 162x324 cm - 63<sup>3</sup>/<sub>4</sub>"x127<sup>1</sup>/<sub>2</sub>"

A647 Travertino Sand Hammered - 12 mm ST \*

**atlasPLAN** SINGLE SLAB NON RECTIFIED  
 162x324 cm - 63<sup>3</sup>/<sub>4</sub>"x127<sup>1</sup>/<sub>2</sub>"

A4UO White Cloud Silk - 12 mm ST \*

**atlasPLAN** SINGLE SLAB NON RECTIFIED  
 162x324 cm - 63<sup>3</sup>/<sub>4</sub>"x127<sup>1</sup>/<sub>2</sub>"

AMJ9 Light Grey Stone Silk - 12 mm ST \*

**atlasPLAN** SINGLE SLAB NON RECTIFIED  
 162x324 cm - 63<sup>3</sup>/<sub>4</sub>"x127<sup>1</sup>/<sub>2</sub>"

A07Y Nero Marquina Silk - 6 mm ST \*  
 ANWA Nero Marquina Polished - 12 mm ST \*  
 ANVK Nero Marquina Silk - 12 mm ST \*  
 A3M5 Nero Marquina Satin - 12 mm ST \*  
 A6T4 Nero Marquina Bookmatch Silk - 12 mm ST \*  
 A6T5 Nero Marquina Bookmatch Polished - 12 mm ST \*  
 A6T6 Nero Marquina Bookmatch Satin - 12 mm ST \*  
 A2XT Nero Marquina Silk - 20 mm

◆ The various graphics of the product are distributed randomly in the boxes, without the possibility of choosing between the available patterns.  
 \* With fiberglass mesh (translations: page 433)

INDEX



PRODUCT  
FINDER



SURFACE  
RANGE



COMPANY



COLLECTIONS



LARGE SIZES



TECHNICAL  
SPECIFICATIONS



# Large Sizes

## Porcelain Tiles

### Metal Look

### Concrete Look



Sizes	Thickness	Surface finish
120x120 cm - 47 1/4" x 47 1/4"	± 9 mm	Matte
120x278 cm - 47 1/4" x 109 1/2"	± 6 mm	Matte

Sizes	Thickness	Surface finish
120x120 cm - 47 1/4" x 47 1/4"	± 9 mm	Matte
120x278 cm - 47 1/4" x 109 1/2"	± 6 mm	Matte

Sizes	Thickness	Surface finish
120x120 cm - 47 1/4" x 47 1/4"	± 9 mm	Matte
120x278 cm - 47 1/4" x 109 1/2"	± 6 mm	Matte
162x324 cm - 63 3/4" x 127 1/2"	± 12 mm	Matte

Sizes	Thickness	Surface finish
120x120 cm - 47 1/4" x 47 1/4"	± 6 mm	Matte
	± 9 mm	Matte
120x240 cm - 47 1/4" x 94 1/2"	± 9 mm	Matte
120x278 cm - 47 1/4" x 109 1/2"	± 6 mm	Matte

Sizes	Thickness	Surface finish
120x120 cm - 47 1/4" x 47 1/4"	± 9 mm	Matte
120x278 cm - 47 1/4" x 109 1/2"	± 6 mm	Matte

Sizes	Thickness	Surface finish
120x120 cm - 47 1/4" x 47 1/4"	± 9 mm	Matte
120x278 cm - 47 1/4" x 109 1/2"	± 6 mm	Matte

APPK Blaze Aluminium 120x120  
APO7 Blaze Aluminium 120x278

APPW Blaze Corten 120x120  
APO8 Blaze Corten 120x278

APPX Blaze Iron 120x120  
APO9 Blaze Iron 120x278

AØCQ Boost Pro Ivory 120x120 6 mm  
AØAF Boost Pro Ivory 120x120  
AØCF Boost Pro Ivory 120x240  
AØCK Boost Pro Ivory 120x278

A65N Boost Natural Kaolin 120x120  
A67B Boost Natural Kaolin 120x278

A6WT Boost Natural Ash 120x120  
A67C Boost Natural Ash 120x278

**atlasPLAN** SINGLE SLAB NON RECTIFIED  
162x324 cm - 63 3/4" x 127 1/2"

A3ND Blaze Iron Matt - 12mm ST \*

◆ The various graphics of the product are distributed randomly in the boxes, without the possibility of choosing between the available patterns.  
\* With fiberglass mesh (translations: page 433)

INDEX



PRODUCT FINDER



SURFACE RANGE



COMPANY



COLLECTIONS



LARGE SIZES



TECHNICAL SPECIFICATIONS



# Large Sizes

## Porcelain Tiles

### Concrete Look



BOOST PRO  
CREAM

Sizes	Thickness	Surface finish
120x120 cm - 47 1/4" x 47 1/4"	± 6 mm	Matte
	± 9 mm	Matte
120x240 cm - 47 1/4" x 94 1/2"	± 9 mm	Matte
120x278 cm - 47 1/4" x 109 1/2"	± 6 mm	Matte

AØCR Boost Pro Cream 120x120 6 mm  
AØAH Boost Pro Cream 120x120  
AØCG Boost Pro Cream 120x240  
AØCM Boost Pro Cream 120x278



BOOST NATURAL  
ECRU

Sizes	Thickness	Surface finish
120x120 cm - 47 1/4" x 47 1/4"	± 9 mm	Matte
120x278 cm - 47 1/4" x 109 1/2"	± 6 mm	Matte
162x324 cm - 63 3/4" x 127 1/2"	± 12 mm	Hammered

A6WU Boost Natural Ecrú 120x120  
A67D Boost Natural Ecrú 120x278

**atlasPLAN** SINGLE SLAB NON RECTIFIED  
162x324 cm - 63 3/4" x 127 1/2"

A649 Boost Natural Ecrú Hammered - 12 mm ST \*



BOOST PRO  
CLAY

Sizes	Thickness	Surface finish
120x120 cm - 47 1/4" x 47 1/4"	± 6 mm	Matte
	± 9 mm	Matte
120x240 cm - 47 1/4" x 94 1/2"	± 9 mm	Matte
120x278 cm - 47 1/4" x 109 1/2"	± 6 mm	Matte
160x160 cm - 63" x 63"	± 6 mm	Matte
160x320 cm - 63" x 126"	± 6 mm	Matte

AØCS Boost Pro Clay 120x120 6 mm  
AØAJ Boost Pro Clay 120x120  
AØCJ Boost Pro Clay 120x240  
AØCN Boost Pro Clay 120x278  
AØQG Boost Pro Clay 160x160  
AØQE Boost Pro Clay 160x320



BOOST  
WHITE

Sizes	Thickness	Surface finish
120x120 cm - 47 1/4" x 47 1/4"	± 6 mm	Matte
	± 9 mm	Matte
120x240 cm - 47 1/4" x 94 1/2"	± 9 mm	Matte
120x278 cm - 47 1/4" x 109 1/2"	± 6 mm	Matte
160x160 cm - 63" x 63"	± 6 mm	Matte
160x320 cm - 63" x 126"	± 6 mm	Matte
162x324 cm - 63 3/4" x 127 1/2"	± 6-12 mm	Hammered

A2TK Boost White 120x120 6 mm  
AMGI Boost White 120x120  
AMGD Boost White 120x240  
AØBD Boost White 120x278  
AØDE Boost White 160x160RT  
AØ5Z Boost White 160x320RT

**atlasPLAN** SINGLE SLAB NON RECTIFIED  
162x324 cm - 63 3/4" x 127 1/2"

ANIM Boost White Hammered - 6 mm ST \*  
ANVX Boost White Hammered - 12 mm ST \*



BOOST  
PEARL

Sizes	Thickness	Surface finish
120x120 cm - 47 1/4" x 47 1/4"	± 6 mm	Matte
	± 9 mm	Matte
120x240 cm - 47 1/4" x 94 1/2"	± 9 mm	Matte
120x278 cm - 47 1/4" x 109 1/2"	± 6 mm	Matte

A2TM Boost Pearl 120x120 6 mm  
AMGJ Boost Pearl 120x120  
AMGE Boost Pearl 120x240  
AØBE Boost Pearl 120x278



BOOST  
GREY

Sizes	Thickness	Surface finish
120x120 cm - 47 1/4" x 47 1/4"	± 6 mm	Matte
	± 9 mm	Matte
120x240 cm - 47 1/4" x 94 1/2"	± 9 mm	Matte
120x278 cm - 47 1/4" x 109 1/2"	± 6 mm	Matte
160x160 cm - 63" x 63"	± 6 mm	Matte
160x320 cm - 63" x 126"	± 6 mm	Matte
162x324 cm - 63 3/4" x 127 1/2"	± 12 mm	Hammered

A2TN Boost Grey 120x120 6 mm  
AMGK Boost Grey 120x120  
AMGF Boost Grey 120x240  
AØBF Boost Grey 120x278  
A68K Boost Grey 160x160RT  
A68I Boost Grey 160x320RT

**atlasPLAN** SINGLE SLAB NON RECTIFIED  
162x324 cm - 63 3/4" x 127 1/2"

A65C Boost Grey Hammered - 12 mm ST \*

◆ The various graphics of the product are distributed randomly in the boxes, without the possibility of choosing between the available patterns.  
\* With fiberglass mesh (translations: page 433)

# Large Sizes

## Porcelain Tiles

## Concrete Look



Sizes	Thickness	Surface finish
120x120 cm - 47 1/4" x 47 1/4"	± 6 mm	Matte
	± 9 mm	Matte
120x240 cm - 47 1/4" x 94 1/2"	± 9 mm	Matte
120x278 cm - 47 1/4" x 109 1/2"	± 6 mm	Matte
160x160 cm - 63" x 63"	± 6 mm	Matte
160x320 cm - 63" x 126"	± 6 mm	Matte

Sizes	Thickness	Surface finish
120x120 cm - 47 1/4" x 47 1/4"	± 9 mm	Matte
120x278 cm - 47 1/4" x 109 1/2"	± 6 mm	Matte

Sizes	Thickness	Surface finish
120x120 cm - 47 1/4" x 47 1/4"	± 6 mm	Matte
	± 9 mm	Matte
120x240 cm - 47 1/4" x 94 1/2"	± 9 mm	Matte
120x278 cm - 47 1/4" x 109 1/2"	± 6 mm	Matte

Sizes	Thickness	Surface finish
120x120 cm - 47 1/4" x 47 1/4"	± 6 mm	Matte
	± 9 mm	Matte
120x240 cm - 47 1/4" x 94 1/2"	± 9 mm	Matte
120x278 cm - 47 1/4" x 109 1/2"	± 6 mm	Matte
160x160 cm - 63" x 63"	± 6 mm	Matte
160x320 cm - 63" x 126"	± 6 mm	Matte
162x324 cm - 63 3/4" x 127 1/2"	± 6-12-20 mm	Hammered
NON RECTIFIED		

Sizes	Thickness	Surface finish
120x120 cm - 47 1/4" x 47 1/4"	± 9 mm	Matte
120x278 cm - 47 1/4" x 109 1/2"	± 6 mm	Matte

Sizes	Thickness	Surface finish
120x120 cm - 47 1/4" x 47 1/4"	± 6 mm	Matte
	± 9 mm	Matte
120x240 cm - 47 1/4" x 94 1/2"	± 9 mm	Matte
120x120 cm - 47 1/4" x 47 1/4"	± 6 mm	Matte
120x278 cm - 47 1/4" x 109 1/2"	± 6 mm	Matte
160x160 cm - 63" x 63"	± 6 mm	Matte
160x320 cm - 63" x 126"	± 6 mm	Matte
162x324 cm - 63 3/4" x 127 1/2"	± 12 mm	Hammered
NON RECTIFIED		

AØCT Boost Pro Taupe 120x120 6 mm  
 AØAL Boost Pro Taupe 120x120  
 AØCH Boost Pro Taupe 120x240  
 AØCO Boost Pro Taupe 120x278  
 AØQH Boost Pro Taupe 160x160  
 AØQF Boost Pro Taupe 160x320

A65O Boost Natural Umber 120x120  
 A67E Boost Natural Umber 120x278

AØCU Boost Pro Tobacco 120x120 6 mm  
 AØAN Boost Pro Tobacco 120x120  
 AØCI Boost Pro Tobacco 120x240  
 AØCP Boost Pro Tobacco 120x278

A2TO Boost Smoke 120x120 6 mm  
 AMGL Boost Smoke 120x120  
 AMGG Boost Smoke 120x240  
 AØBG Boost Smoke 120x278  
 AØDF Boost Smoke 160x160RT  
 AØ5Ø Boost Smoke 160x320RT

A65P Boost Natural Coal 120x120  
 A67F Boost Natural Coal 120x278

A2TP Boost Tarmac 120x120 6 mm  
 AMGM Boost Tarmac 120x120  
 AMGH Boost Tarmac 120x240  
 AOQB Boost Tarmac 120x278  
 A68L Boost Tarmac 160x160RT  
 A68J Boost Tarmac 160x320RT

atlasPLAN SINGLE SLAB NON RECTIFIED  
 162x324 cm - 63 3/4" x 127 1/2"

ANIO Boost Smoke Hammered - 6 mm ST \*  
 ANVØ Boost Smoke Hammered - 12 mm ST \*  
 A2XV Boost Smoke Hammered - 20 mm

atlasPLAN SINGLE SLAB NON RECTIFIED  
 162x324 cm - 63 3/4" x 127 1/2"

A65D Boost Tarmac Hammered - 12 mm ST \*

◆ The various graphics of the product are distributed randomly in the boxes, without the possibility of choosing between the available patterns.  
 \* With fiberglass mesh (translations: page 433)

INDEX



PRODUCT FINDER



SURFACE RANGE



COMPANY



COLLECTIONS



LARGE SIZES



TECHNICAL SPECIFICATIONS





# Large Sizes

## Porcelain Tiles

Concrete Look



PRISM  
CORD

Sizes	Thickness	Surface finish
120x120 cm - 47 <sup>1</sup> / <sub>4</sub> "x47 <sup>1</sup> / <sub>4</sub> "	± 9 mm	Silk   Matte
120x278 cm - 47 <sup>1</sup> / <sub>4</sub> "x109 <sup>1</sup> / <sub>2</sub> "	± 6 mm	Matte

A4ON Prism Cord 120x120 Silk  
A4OH Prism Cord 120x120  
A4UQ Prism Cord 120x278



RAW  
SAND

Sizes	Thickness	Surface finish
120x120 cm - 47 <sup>1</sup> / <sub>4</sub> "x47 <sup>1</sup> / <sub>4</sub> "	± 9 mm	Matte
120x278 cm - 47 <sup>1</sup> / <sub>4</sub> "x109 <sup>1</sup> / <sub>2</sub> "	± 6 mm	Matte

APMU Raw Sand 120x120  
APMY Raw Sand 120x278



BOOST NATURAL  
CORAL

Sizes	Thickness	Surface finish
120x120 cm - 47 <sup>1</sup> / <sub>4</sub> "x47 <sup>1</sup> / <sub>4</sub> "	± 9 mm	Matte
120x278 cm - 47 <sup>1</sup> / <sub>4</sub> "x109 <sup>1</sup> / <sub>2</sub> "	± 6 mm	Matte

A65R Boost Natural Coral 120x120  
A67H Boost Natural Coral 120x278



RAW  
MUD

Sizes	Thickness	Surface finish
120x120 cm - 47 <sup>1</sup> / <sub>4</sub> "x47 <sup>1</sup> / <sub>4</sub> "	± 9 mm	Matte
120x278 cm - 47 <sup>1</sup> / <sub>4</sub> "x109 <sup>1</sup> / <sub>2</sub> "	± 6 mm	Matte

APMV Raw Mud 120x120  
APMZ Raw Mud 120x278



PRISM  
SUEDE

Sizes	Thickness	Surface finish
120x120 cm - 47 <sup>1</sup> / <sub>4</sub> "x47 <sup>1</sup> / <sub>4</sub> "	± 9 mm	Silk   Matte
120x278 cm - 47 <sup>1</sup> / <sub>4</sub> "x109 <sup>1</sup> / <sub>2</sub> "	± 6 mm	Matte

A4OM Prism Suede 120x120 Silk  
A4OG Prism Suede 120x120  
A4UP Prism Suede 120x278

◆ The various graphics of the product are distributed randomly in the boxes, without the possibility of choosing between the available patterns. (translations: page 433)

INDEX



PRODUCT  
FINDER



SURFACE  
RANGE



COMPANY



COLLECTIONS



LARGE SIZES



TECHNICAL  
SPECIFICATIONS



# Large Sizes

## Porcelain Tiles

### Concrete Look



RAW  
WHITE

Sizes	Thickness	Surface finish
120x120 cm - 47 1/4" x 47 1/4"	± 9 mm	Matte
120x278 cm - 47 1/4" x 109 1/2"	± 6 mm	Matte

APMK Raw White 120x120  
APMW Raw White 120x278



RAW  
PEARL

Sizes	Thickness	Surface finish
120x120 cm - 47 1/4" x 47 1/4"	± 9 mm	Matte
120x278 cm - 47 1/4" x 109 1/2"	± 6 mm	Matte

APML Raw Pearl 120x120  
APMX Raw Pearl 120x278



PRISM  
COTTON

Sizes	Thickness	Surface finish
120x120 cm - 47 1/4" x 47 1/4"	± 9 mm	Silk   Matte
120x278 cm - 47 1/4" x 109 1/2"	± 6 mm	Matte

A4OO Prism Cotton 120x120 Silk  
A4OI Prism Cotton 120x120  
A4UR Prism Cotton 120x278

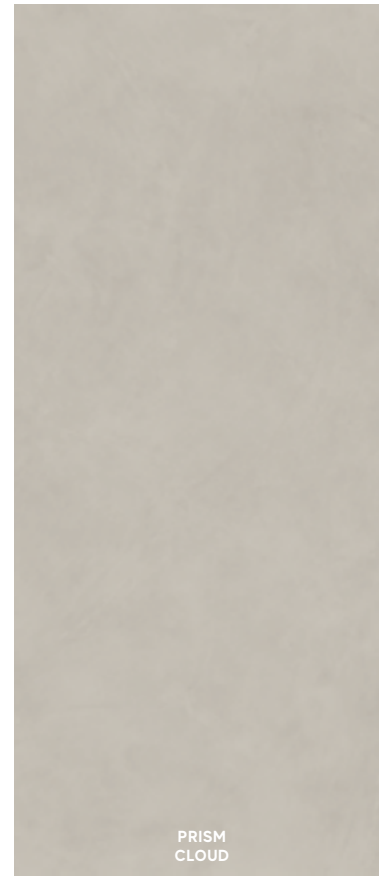

PRISM  
CLOUD

Sizes	Thickness	Surface finish
120x120 cm - 47 1/4" x 47 1/4"	± 9 mm	Silk   Matte
120x278 cm - 47 1/4" x 109 1/2"	± 6 mm	Matte

A4OP Prism Cloud 120x120 Silk  
A4OJ Prism Cloud 120x120  
A4US Prism Cloud 120x278



PRISM  
FOG

Sizes	Thickness	Surface finish
120x120 cm - 47 1/4" x 47 1/4"	± 9 mm	Silk   Matte
120x278 cm - 47 1/4" x 109 1/2"	± 6 mm	Matte

A4OQ Prism Fog 120x120 Silk  
A4OK Prism Fog 120x120  
A4UT Prism Fog 120x278

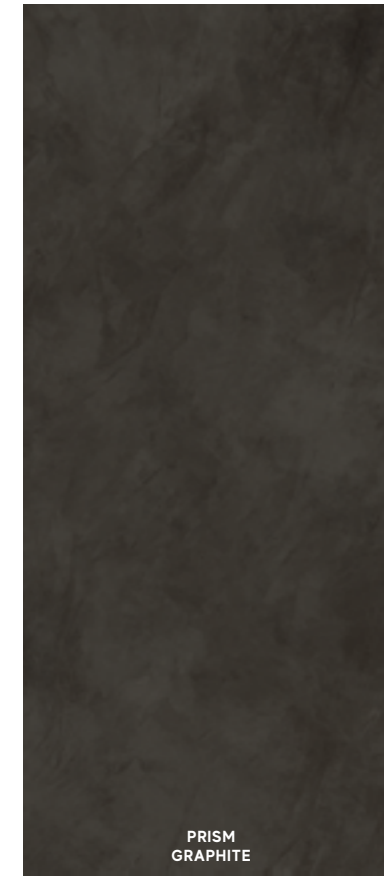

PRISM  
GRAPHITE

Sizes	Thickness	Surface finish
120x120 cm - 47 1/4" x 47 1/4"	± 9 mm	Silk   Matte
120x278 cm - 47 1/4" x 109 1/2"	± 6 mm	Matte

A4OR Prism Graphite 120x120 Silk  
A4OL Prism Graphite 120x120  
A4UU Prism Graphite 120x278

◆ The various graphics of the product are distributed randomly in the boxes, without the possibility of choosing between the available patterns. (translations: page 433)

INDEX



PRODUCT  
FINDER



SURFACE  
RANGE



COMPANY



COLLECTIONS



LARGE SIZES



TECHNICAL  
SPECIFICATIONS



# Large Sizes

## Porcelain Tiles

### Stone Look



BOOST MIX  
IVORY

Sizes	Thickness	Surface finish
120x120 cm - 47 <sup>1</sup> / <sub>4</sub> "x47 <sup>1</sup> / <sub>4</sub> "	± 9 mm	Matte
120x278 cm - 47 <sup>1</sup> / <sub>4</sub> "x109 <sup>1</sup> / <sub>2</sub> "	± 6 mm	Matte

A8XD Boost Mix Ivory 120x120  
A8Y7 Boost Mix Ivory 120x278



LIMS  
IVORY

Sizes	Thickness	Surface finish
120x120 cm - 47 <sup>1</sup> / <sub>4</sub> "x47 <sup>1</sup> / <sub>4</sub> "	± 9 mm	Matte
120x278 cm - 47 <sup>1</sup> / <sub>4</sub> "x109 <sup>1</sup> / <sub>2</sub> "	± 6 mm	Matte

A3DI Lims Ivory 120x120  
A3EI Lims Ivory 120x278



BOOST STONE  
IVORY

Sizes	Thickness	Surface finish
120x120 cm - 47 <sup>1</sup> / <sub>4</sub> "x47 <sup>1</sup> / <sub>4</sub> "	± 9 mm	Matte
120x278 cm - 47 <sup>1</sup> / <sub>4</sub> "x109 <sup>1</sup> / <sub>2</sub> "	± 6 mm	Matte
162x324 cm - 63 <sup>3</sup> / <sub>4</sub> "x127 <sup>1</sup> / <sub>2</sub> "	± 12 mm	Hammered NON RECTIFIED

A6QT Boost Stone Ivory 120x120  
A6R8 Boost Stone Ivory 120x278

**atlasPLAN** SINGLE SLAB NON RECTIFIED  
162x324 cm - 63<sup>3</sup>/<sub>4</sub>"x127<sup>1</sup>/<sub>2</sub>"

A648 Boost Stone Ivory Hammered - 12 mm ST \*

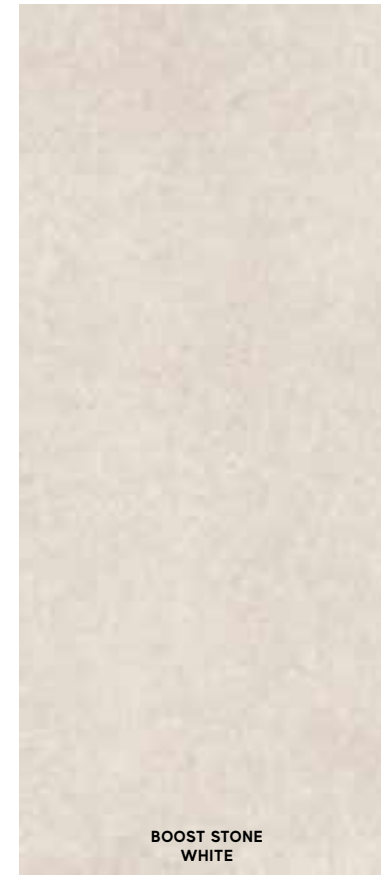

BOOST STONE  
WHITE

Sizes	Thickness	Surface finish
120x120 cm - 47 <sup>1</sup> / <sub>4</sub> "x47 <sup>1</sup> / <sub>4</sub> "	± 9 mm	Matte
120x278 cm - 47 <sup>1</sup> / <sub>4</sub> "x109 <sup>1</sup> / <sub>2</sub> "	± 6 mm	Matte

A6QS Boost Stone White 120x120  
A6R7 Boost Stone White 120x278

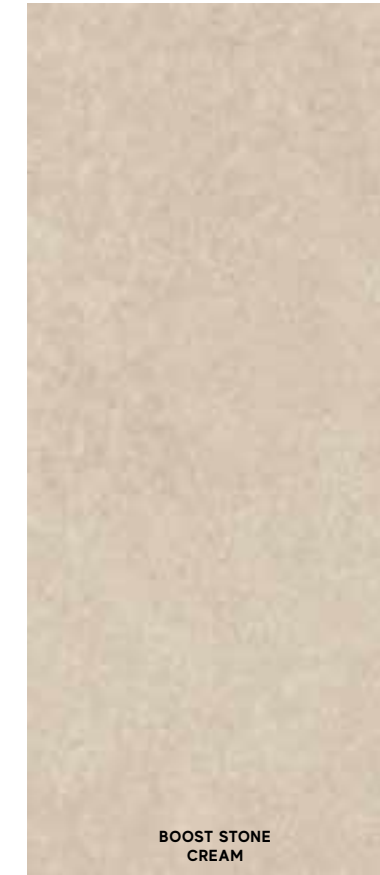

BOOST STONE  
CREAM

Sizes	Thickness	Surface finish
120x120 cm - 47 <sup>1</sup> / <sub>4</sub> "x47 <sup>1</sup> / <sub>4</sub> "	± 9 mm	Matte
120x278 cm - 47 <sup>1</sup> / <sub>4</sub> "x109 <sup>1</sup> / <sub>2</sub> "	± 6 mm	Matte

A6QU Boost Stone Cream 120x120  
A6R9 Boost Stone Cream 120x278



LIMS  
BEIGE

Sizes	Thickness	Surface finish
120x120 cm - 47 <sup>1</sup> / <sub>4</sub> "x47 <sup>1</sup> / <sub>4</sub> "	± 9 mm	Matte
120x278 cm - 47 <sup>1</sup> / <sub>4</sub> "x109 <sup>1</sup> / <sub>2</sub> "	± 6 mm	Matte

A3DJ Lims Beige 120x120  
A3EJ Lims Beige 120x278

◆ The various graphics of the product are distributed randomly in the boxes, without the possibility of choosing between the available patterns.  
\* With fiberglass mesh (translations: page 433)

# Large Sizes

## Porcelain Tiles

Stone Look



LIMS  
GREY

Sizes	Thickness	Surface finish
120x120 cm - 47 <sup>1</sup> / <sub>4</sub> "x47 <sup>1</sup> / <sub>4</sub> "	± 9 mm	Matte
120x278 cm - 47 <sup>1</sup> / <sub>4</sub> "x109 <sup>1</sup> / <sub>2</sub> "	± 6 mm	Matte

A3DK Lims Grey 120x120  
A3EK Lims Grey 120x278



LIMS  
DESERT

Sizes	Thickness	Surface finish
120x120 cm - 47 <sup>1</sup> / <sub>4</sub> "x47 <sup>1</sup> / <sub>4</sub> "	± 9 mm	Matte
120x278 cm - 47 <sup>1</sup> / <sub>4</sub> "x109 <sup>1</sup> / <sub>2</sub> "	± 6 mm	Matte

A3DL Lims Desert 120x120  
A3EL Lims Desert 120x278



BOOST STONE  
CLAY

Sizes	Thickness	Surface finish
120x120 cm - 47 <sup>1</sup> / <sub>4</sub> "x47 <sup>1</sup> / <sub>4</sub> "	± 9 mm	Matte
120x278 cm - 47 <sup>1</sup> / <sub>4</sub> "x109 <sup>1</sup> / <sub>2</sub> "	± 6 mm	Matte

A6QV Boost Stone Clay 120x120  
A6SA Boost Stone Clay 120x278



BOOST STONE  
TAUPE

Sizes	Thickness	Surface finish
120x120 cm - 47 <sup>1</sup> / <sub>4</sub> "x47 <sup>1</sup> / <sub>4</sub> "	± 9 mm	Matte
120x278 cm - 47 <sup>1</sup> / <sub>4</sub> "x109 <sup>1</sup> / <sub>2</sub> "	± 6 mm	Matte

A6QW Boost Stone Taupe 120x120  
A6SB Boost Stone Taupe 120x278



BOOST STONE  
TOBACCO

Sizes	Thickness	Surface finish
120x120 cm - 47 <sup>1</sup> / <sub>4</sub> "x47 <sup>1</sup> / <sub>4</sub> "	± 9 mm	Matte
120x278 cm - 47 <sup>1</sup> / <sub>4</sub> "x109 <sup>1</sup> / <sub>2</sub> "	± 6 mm	Matte

A6QZ Boost Stone Tobacco 120x120  
A6SF Boost Stone Tobacco 120x278

◆ The various graphics of the product are distributed randomly in the boxes, without the possibility of choosing between the available patterns. (translations: page 433)

INDEX



PRODUCT  
FINDER



SURFACE  
RANGE



COMPANY



COLLECTIONS



LARGE SIZES



TECHNICAL  
SPECIFICATIONS



# Large Sizes

## Porcelain Tiles

Stone Look



BOOST MIX PEARL

Sizes	Thickness	Surface finish
120x120 cm - 47 1/4" x 47 1/4"	± 9 mm	Matte
120x278 cm - 47 1/4" x 109 1/2"	± 6 mm	Matte

A8XE Boost Mix Pearl 120x120  
A8Y8 Boost Mix Pearl 120x278



BOOST STONE PEARL

Sizes	Thickness	Surface finish
120x120 cm - 47 1/4" x 47 1/4"	± 9 mm	Matte
120x278 cm - 47 1/4" x 109 1/2"	± 6 mm	Matte

A6QX Boost Stone Pearl 120x120  
A6SD Boost Stone Pearl 120x278



BOOST STONE GREY

Sizes	Thickness	Surface finish
120x120 cm - 47 1/4" x 47 1/4"	± 9 mm	Matte
120x278 cm - 47 1/4" x 109 1/2"	± 6 mm	Matte

A6QY Boost Stone Grey 120x120  
A6SC Boost Stone Grey 120x278



BOOST STONE SMOKE

Sizes	Thickness	Surface finish
120x120 cm - 47 1/4" x 47 1/4"	± 9 mm	Matte
120x278 cm - 47 1/4" x 109 1/2"	± 6 mm	Matte

A6L8 Boost Stone Smoke 120x120  
A6SE Boost Stone Smoke 120x278

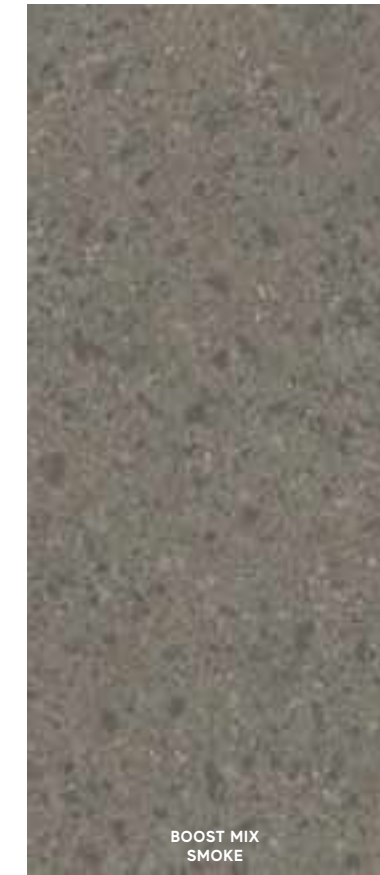

BOOST MIX SMOKE

Sizes	Thickness	Surface finish
120x120 cm - 47 1/4" x 47 1/4"	± 9 mm	Matte
120x278 cm - 47 1/4" x 109 1/2"	± 6 mm	Matte

A8XF Boost Mix Smoke 120x120  
A8Y9 Boost Mix Smoke 120x278



BOOST STONE TARMAC

Sizes	Thickness	Surface finish
120x120 cm - 47 1/4" x 47 1/4"	± 9 mm	Matte
120x278 cm - 47 1/4" x 109 1/2"	± 6 mm	Matte

A6QØ Boost Stone Tarmac 120x120  
A6SG Boost Stone Tarmac 120x278

◆ The various graphics of the product are distributed randomly in the boxes, without the possibility of choosing between the available patterns. (translations: page 433)

INDEX



PRODUCT FINDER



SURFACE RANGE



COMPANY



COLLECTIONS



LARGE SIZES



TECHNICAL SPECIFICATIONS



# Large Sizes

## Porcelain Tiles

### Stone Look



Sizes	Thickness	Surface finish
120x120 cm - 47 1/4" x 47 1/4"	± 9 mm	Matte
120x240 cm - 47 1/4" x 94 1/2"	± 9 mm	Matte

Sizes	Thickness	Surface finish
120x120 cm - 47 1/4" x 47 1/4"	± 9 mm	Matte
120x240 cm - 47 1/4" x 94 1/2"	± 9 mm	Matte

Sizes	Thickness	Surface finish
120x120 cm - 47 1/4" x 47 1/4"	± 9 mm	Matte
120x240 cm - 47 1/4" x 94 1/2"	± 9 mm	Matte
162x324 cm - 63 3/4" x 127 1/2"	± 6-12-20 mm	Hammered

Sizes	Thickness	Surface finish
162x324 cm - 63 3/4" x 127 1/2"	± 12 mm	Hammered

Sizes	Thickness	Surface finish
162x324 cm - 63 3/4" x 127 1/2"	± 6-12 mm	Hammered

Sizes	Thickness	Surface finish
162x324 cm - 63 3/4" x 127 1/2"	± 6-12 mm	Hammered

AZT5 Marvel Clauzetto White 120x120 Matt  
AZT2 Marvel Clauzetto White 120x240 Matt

AZT4 Marvel Cardoso Elegant 120x120  
AZT1 Marvel Cardoso Elegant 120x240

AZT3 Marvel Basaltina Volcano 120x120 Matt  
AZTØ Marvel Basaltina Volcano 120x240 Matt

**atlasPLAN** SINGLE SLAB NON RECTIFIED  
162x324 cm - 63 3/4" x 127 1/2"

AL9Z Basaltina Volcano Hammered - 6 mm ST \*  
ANVI Basaltina Volcano Hammered - 12 mm ST \*  
A2XS Basaltina Volcano Hammered - 20 mm

**atlasPLAN** SINGLE SLAB NON RECTIFIED  
162x324 cm - 63 3/4" x 127 1/2"

AMKD Kone Gypsum Hammered - 12 mm ST \*

**atlasPLAN** SINGLE SLAB NON RECTIFIED  
162x324 cm - 63 3/4" x 127 1/2"

ANIQ Kone Mix Hammered - 6 mm ST \*  
AMXS Kone Mix Hammered - 12 mm ST \*

**atlasPLAN** SINGLE SLAB NON RECTIFIED  
162x324 cm - 63 3/4" x 127 1/2"

ANIT Kone Grey Hammered - 6 mm ST \*  
ANXH Kone Grey Hammered - 12 mm ST \*

◆ The various graphics of the product are distributed randomly in the boxes, without the possibility of choosing between the available patterns.  
\* With fiberglass mesh (translations: page 433)

# Large Sizes

## Porcelain Tiles

### Stone Look

### Solid Look

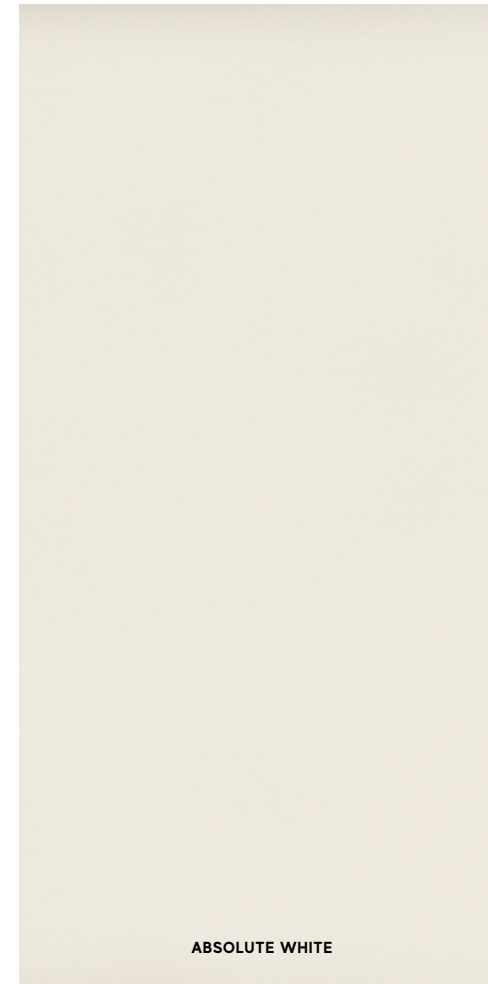
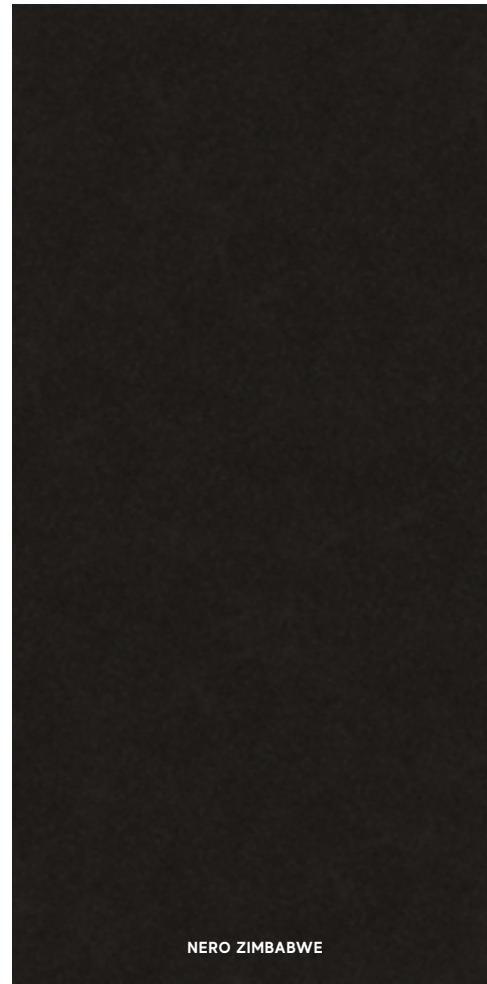

**Sizes** **Thickness** **Surface finish**

**162x324 cm - 63<sup>3</sup>/<sub>4</sub>"x127<sup>1</sup>/<sub>2</sub>"** **± 12-20** Flamed  
**NON RECTIFIED** **mm**

**Sizes** **Thickness** **Surface finish**

**162x324 cm - 63<sup>3</sup>/<sub>4</sub>"x127<sup>1</sup>/<sub>2</sub>"** **± 12-20** Hammered  
**NON RECTIFIED** **mm**

**Sizes** **Thickness** **Surface finish**

**162x324 cm - 63<sup>3</sup>/<sub>4</sub>"x127<sup>1</sup>/<sub>2</sub>"** **± 6-12-20** Flamed  
**NON RECTIFIED** **mm**

**Sizes** **Thickness** **Surface finish**

**162x324 cm - 63<sup>3</sup>/<sub>4</sub>"x127<sup>1</sup>/<sub>2</sub>"** **± 6 mm** Matte  
**NON RECTIFIED** **± 12-20** Silk | Polished  
**mm**

**Sizes** **Thickness** **Surface finish**

**162x324 cm - 63<sup>3</sup>/<sub>4</sub>"x127<sup>1</sup>/<sub>2</sub>"** **± 12 mm** Silk  
**NON RECTIFIED**

**atlasPLAN** SINGLE SLAB NON RECTIFIED  
 162x324 cm - 63<sup>3</sup>/<sub>4</sub>"x127<sup>1</sup>/<sub>2</sub>"

AØX8 Dolmen Pro Grigio Flamed - 12 mm ST \*  
 A2XP Dolmen Pro Grigio Flamed - 20 mm

**atlasPLAN** SINGLE SLAB NON RECTIFIED  
 162x324 cm - 63<sup>3</sup>/<sub>4</sub>"x127<sup>1</sup>/<sub>2</sub>"

A4UN Soapstone Dark Hammered - 12 mm ST \*  
 A5I3 Soapstone Dark Hammered - 20 mm \*

**atlasPLAN** SINGLE SLAB NON RECTIFIED  
 162x324 cm - 63<sup>3</sup>/<sub>4</sub>"x127<sup>1</sup>/<sub>2</sub>"

A2YE Nero Zimbabwe Flamed - 6 mm ST \*  
 AØY3 Nero Zimbabwe Flamed - 12 mm ST \*  
 A2XQ Nero Zimbabwe Flamed - 20 mm

**atlasPLAN** SINGLE SLAB NON RECTIFIED  
 162x324 cm - 63<sup>3</sup>/<sub>4</sub>"x127<sup>1</sup>/<sub>2</sub>"

AØ7Z Absolute White Matt - 6 mm ST \*  
 AMJ7 Absolute White Silk - 12 mm ST \*  
 A4T4 Absolute White Polished - 12 mm ST \*  
 AOOB Absolute White Silk - 20 mm  
 A53S Absolute White Polished - 20 mm

**atlasPLAN** SINGLE SLAB NON RECTIFIED  
 162x324 cm - 63<sup>3</sup>/<sub>4</sub>"x127<sup>1</sup>/<sub>2</sub>"

A23J Absolute Black Silk - 12 mm ST \*

◆ The various graphics of the product are distributed randomly in the boxes, without the possibility of choosing between the available patterns.  
 \* With fiberglass mesh (translations: page 433)

# Large Sizes

## Glazed Porcelain Tiles

### Color & Decor



**Sizes**                      **Thickness**   **Surface finish**  
**120x278 cm** - 47<sup>1</sup>/<sub>4</sub>"x109<sup>1</sup>/<sub>2</sub>"   ± 6 mm   Matte

**Sizes**                      **Thickness**   **Surface finish**  
**120x278 cm** - 47<sup>1</sup>/<sub>4</sub>"x109<sup>1</sup>/<sub>2</sub>"   ± 6 mm   Matte

**Sizes**                      **Thickness**   **Surface finish**  
**120x278 cm** - 47<sup>1</sup>/<sub>4</sub>"x109<sup>1</sup>/<sub>2</sub>"   ± 6 mm   Matte

**Sizes**                      **Thickness**   **Surface finish**  
**120x120 cm** - 47<sup>1</sup>/<sub>4</sub>"x47<sup>1</sup>/<sub>4</sub>"   ± 9 mm   Matte  
**120x278 cm** - 47<sup>1</sup>/<sub>4</sub>"x109<sup>1</sup>/<sub>2</sub>"   ± 6 mm   Matte

**Sizes**                      **Thickness**   **Surface finish**  
**120x278 cm** - 47<sup>1</sup>/<sub>4</sub>"x109<sup>1</sup>/<sub>2</sub>"   ± 6 mm   Matte

**Sizes**                      **Thickness**   **Surface finish**  
**120x278 cm** - 47<sup>1</sup>/<sub>4</sub>"x109<sup>1</sup>/<sub>2</sub>"   ± 6 mm   Matte

A4VH Prism Bloom 120x278 ○ (see page 433)

A4VI Prism Caramel 120x278 ○ (see page 433)

A4VJ Prism Grape 120x278 ○ (see page 433)

A65Q Boost Natural Cobalt 120x120  
 A67G Boost Natural Cobalt 120x278

A4VK Prism Dusk 120x278 ○ (see page 433)

A4VL Prism Midnight 120x278 ○ (see page 433)

◆ The various graphics of the product are distributed randomly in the boxes, without the possibility of choosing between the available patterns.  
 ■ The decoration can only be laid on the wall (translations: page 433)

INDEX



PRODUCT  
FINDER



SURFACE  
RANGE



COMPANY



COLLECTIONS



LARGE SIZES



TECHNICAL  
SPECIFICATIONS







# Large Sizes

## Glazed Porcelain Tiles

INDEX 

### Color & Decor

PRODUCT FINDER 

SURFACE RANGE 

COMPANY 

COLLECTIONS 

LARGE SIZES 

TECHNICAL SPECIFICATIONS 



**Sizes** **Thickness** **Surface finish**  
120x278 cm - 47 1/4"x109 1/2" ± 6 mm Matte

**Sizes** **Thickness** **Surface finish**  
120x278 cm - 47 1/4"x109 1/2" ± 6 mm Matte

A4VM Prism Moss 120x278  (see page 433)

A4VN Prism Emerald 120x278  (see page 433)





**Sizes** **Thickness** **Surface finish**  
120x278 cm - 47 1/4"x109 1/2" ± 6 mm Matte

**Sizes** **Thickness** **Surface finish**  
120x278 cm - 47 1/4"x109 1/2" ± 6 mm Matte

**Sizes** **Thickness** **Surface finish**  
120x278 cm - 47 1/4"x109 1/2" ± 6 mm Matte

A4VP Prism Brush XL 120x278  (see page 433)

A4VO Prism Gradient XL 120x278  (see page 433)

A3HE Boost Pro Leaves 120x278 A  (see page 433)  
A3M2 Boost Pro Leaves 120x278 B  (see page 433)

#### PATTERNS



#### PATTERNS

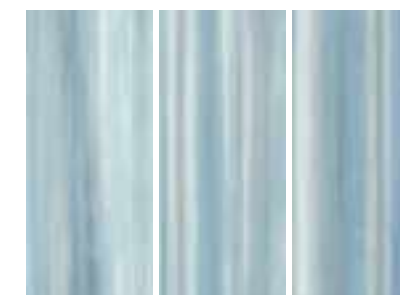

#### PATTERNS



◆ The various graphics of the product are distributed randomly in the boxes, without the possibility of choosing between the available patterns.  
■ The decoration can only be laid on the wall (translations: page 433)

# Large Sizes

## Porcelain Tiles



BOOST PRO GROVE

**Sizes** **Thickness** **Surface finish**  
**120x278 cm - 47 1/4"x109 1/2"** **± 6 mm** **Matte**



BOOST PRO PAINT

**Sizes** **Thickness** **Surface finish**  
**120x278 cm - 47 1/4"x109 1/2"** **± 6 mm** **Matte**

AØLW Boost Pro Grove 120x278

AØLX Boost Pro Paint 120x278

**PATTERNS**



**PATTERNS**

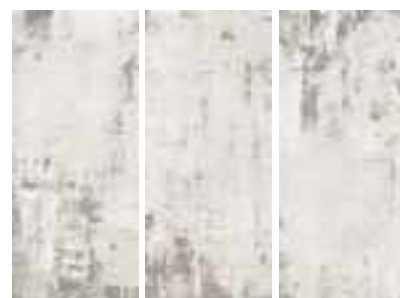

### Color & Decor



© Ceramiche Atlas Concorde

◆ **The various graphics of the product are distributed randomly in the boxes, without the possibility of choosing between the available patterns.** - All'interno delle casse, le varie grafiche del prodotto sono distribuite in modo casuale, senza possibilità di scelta tra i pattern disponibili. - À l'intérieur delle caisses, les différents graphismes du produit sont distribués en mode aléatoire, sans possibilité de choix entre les motifs disponibles. - Die Kisten enthalten die verschiedenen Grafiken des Artikels nach dem Zufallsprinzip, ohne dass Sie zwischen den einzelnen Motiven wählen können. - En el interior de las cajas, los distintos gráficos de los productos se distribuyen de forma aleatoria, sin que se pueda elegir el patrón disponible. - Рисунки распределены в ящиках в случайном порядке, без возможности выбора из доступных рисунков.

■ **The Endless Kit contains all the graphics of the product with vein continuity, ensuring that all the numbered faces in the composition can be found in a single box. The number of the graphic - G1, G2, G3, etc - is printed on the side and indicated with an adhesive label placed on the slab. To reconstruct the surface with continuous veins, simply lay the tiles in numerical progression: G1, G2, G3 and so on.** - Il Kit Endless contiene tutte le grafiche del prodotto con continuità di vena; garantisce in un'unica cassa tutte le facce numerate che creano la composizione. Il numero della grafica, indicato come G1, G2, G3, ecc. viene stampato sulla costa del lato 278 e indicato con un adesivo posto sulla lastra. Per ricostruire la superficie con continuità di vena è sufficiente posare le lastre in progressione numerica: G1, G2, G3, ecc. - Le Kit Endless contient tous les graphismes du produit avec la continuité des veines; il garantit, dans une seule caisse, toutes les faces numérotées qui créent la composition. Le numéro du graphisme, indiqué comme G1, G2, G3, etc. est imprimé sur le bord du côté 278 et indiqué avec un adhésif apposé sur la dalle. Pour reconstruire la surface avec les veines en continuité, il suffit de poser les dalles en progression numérique: G1, G2, G3, etc. - Kit Endless umfasst alle Grafiken des Produkts mit durchlaufender Aderung und damit alle nummerierten Oberflächen, aus denen sich die Komposition zusammensetzt, garantiert in einer einzigen Kiste. Die Nummer der Grafik, d.h. G1, G2, G3, etc., ist auf der Kante der 278 cm langen Seite aufgedruckt und auch mit einem Klebeetikett auf der Platte angegeben. Um das Gesamtbild mit durchlaufender Aderung zusammensetzen, werden die Platten einfach in numerischer Reihenfolge verlegt: G1, G2, G3 usw. - El Kit Endless contiene todas las caras del producto con continuidad de vetas, garantiza contar en una sola caja con todas las caras numeradas que forman la composición. El número del gráfico, indicado como G1, G2, G3, etc., está impreso en el borde del lado 278 y se indica mediante un adhesivo en la losa. Para reconstruir la superficie con continuidad de vetas, basta con colocar las losas en progresión numérica: G1, G2, G3, etc. - Kit Endless - это комплект, который содержит все плиты, необходимые для составления композиции с непрерывным рисунком прожилок. Все плиты пронумерованы и находятся в одном ящике. Номер плиты, обозначенный как G1, G2, G3 и т.д., напечатан на торце грани 278 и указан также на наклейке в углу плиты. Чтобы при облицовке создать рисунок с непрерывающимися прожилками, необходимо просто уложить плиты в последовательности: G1, G2, G3 и т.д.

▲ **Minor misalignments in the continuity of the veins between different graphics is normal for this type of product.** - Eventuali piccoli disallineamenti nella continuità delle venature tra grafiche diverse sono una caratteristica intrinseca di questa tipologia di prodotto. - Les éventuels petits désalignements de la continuité des veines entre différents graphismes sont une caractéristique intrinsèque de cette typologie de produit. - Eventuelle kleine Versätze im Verlauf der Aderungen zwischen unterschiedlichen Grafiken sind charakteristisch für dieses Produkt. - Cualquier pequeño desalineado en la continuidad de las vetas entre diferentes gráficos es una característica intrínseca de este tipo de productos. - Возможные небольшие смещения рисунка прожилок на стыке плит являются характеристикой данного вида изделий.

• **Calacatta Extra Endless is composed of four graphics with vein continuity, but are distributed randomly in the boxes, without the possibility of choosing between the available patterns.** - Calacatta Extra Endless è composto da quattro grafiche con continuità di vena, ma all'interno delle casse queste sono distribuite in modo casuale, senza possibilità di scelta tra i pattern disponibili. - Calacatta Extra Endless est composé de quatre graphismes avec les veines en continuité, mais celles-ci sont distribuées en mode aléatoire à l'intérieur delle caisses, sans possibilité de choix entre les motifs disponibles. - Calacatta Extra Endless besteht aus vier Grafiken mit durchlaufender Aderung; diese sind jedoch in den Kisten nach dem Zufallsprinzip enthalten, ohne dass Sie zwischen den einzelnen Motiven wählen können. - Calacatta Extra Endless se compone de cuatro gráficos con continuidad de vetas, pero en el interior de las cajas están distribuidos de forma aleatoria, sin que se pueda elegir el patrón disponible. - Calacatta Extra Endless состоит из четырех рисунков с непрерывными прожилками, но они распределены в ящиках в случайном порядке, без возможности выбора из доступных рисунков.

○ **The use of a common mild detergent is recommended. Avoid using acidic or alkaline products, waxes, steel wool, or abrasives.** - Si consiglia l'utilizzo di un comune detergente neutro. Evitare l'utilizzo di prodotti acidi o alcalini, ceranti, pagliette di metallo o abrasive. - Nous vous conseillons d'utiliser des détergents neutres courants. Éviter l'utilisation de cires et de produits acides ou alcalins, ainsi que les pailles métalliques ou abrasives. - Es empfiehlt sich, ein haushaltsübliches, neutrales Reinigungsmittel zu verwenden. Saure oder alkalische Produkte, Wachs sowie Metallwolle- bzw. Scheuerschwämme sind zu vermeiden. - Recomendamos utilizar un detergente neutro común. Hay que evitar el uso de productos ácidos o alcalinos, ceras y estropajos de metal o abrasivos. - рекомендуется чистить обычным нейтральным моющим средством. Не рекомендуется использовать кислотные, щелочные, восковые средства, а также металлические мочалки.

🚫 **The decoration can only be laid on the wall** - Il decoro si può posare solo a rivestimento - Décor uniquement mural - Das Dekor kann nur an der Wand verlegt werden - La decoración se puede colocar únicamente en paredes - Декор может быть уложен только на стену.

\* **With fiberglass mesh** - Versione stuoata - Version à nattes - Ausführung mit Glasfasermatte - Versión con malla - С упрочнением из стекловолокна

INDEX



PRODUCT FINDER



SURFACE RANGE



COMPANY



COLLECTIONS



LARGE SIZES



TECHNICAL SPECIFICATIONS





# Technical Specifications

- 436 SIZES RANGE
- 440 PORCELAIN TILES TECHNICAL SPECIFICATION
- 455 UPEC CERTIFICATION
- 456 ANTI-SLIP CLASSIFICATION
- 459 DESTINATIONS OF USE FOR PORCELAIN TILES
- 462 TRIM TILES - INDOOR AND OUTDOOR
- 466 WALL TILES TECHNICAL SPECIFICATION
- 470 PACKING AND WEIGHT
- 476 LAYING SUGGESTIONS
- 488 GENERAL SALES CONDITIONS

INDEX



PRODUCT FINDER



SURFACE RANGE



COMPANY



COLLECTIONS



LARGE SIZES



TECHNICAL SPECIFICATIONS







# Porcelain Tiles Technical Specification

Complies with	EN 14411 (ISO 13006)	Appendix	G	Group	Bla
Conforme alla norma	EN 14411 (ISO 13006)	Appendice	G	Gruppo	Bla
Conforme à la norme	EN 14411 (ISO 13006)	Appendice	G	Groupe	Bla
Entsprechend	EN 14411 (ISO 13006)	Anhang	G	Gruppe	Bla
Conforme a la norma	EN 14411 (ISO 13006)	Apéndice	G	Grupo	Bla
Соответствует норме	EN 14411 (ISO 13006)	Приложение	G	Группа	Bla

- (\*) **The permissible deviation, in % or mm, of the average size for each tile (2 or 4 sides) from work size (WS).**  
Deviazione ammissibile, in % oppure mm, della dimensione media di ogni piastrella (2 oppure 4 lati) dalla dimensione di fabbricazione (WS).
- (\*\*) **The permissible deviation, in % or mm, of the average thickness for each tile from the work size thickness (WS).**  
Deviazione ammissibile, in % oppure mm, dello spessore medio di ogni piastrella dallo spessore riportato nella dimensione di fabbricazione (WS).
- (\*\*\*) **The maximum permissible deviation from straightness, in % or mm, related to the corresponding work sizes (WS).**  
Deviazione massima ammissibile di rettilineità, in % oppure mm, in rapporto alle dimensioni di fabbricazione (WS) corrispondenti.
- (\*\*\*\*) **The maximum permissible deviation from rectangularity, in % or mm, related to the corresponding work sizes (WS).**  
Deviazione massima ammissibile di ortogonalità, in % oppure mm, in rapporto alle dimensioni di fabbricazione (WS) corrispondenti.
- c.c. **The maximum permissible deviation from centre curvature, in % or mm, related to diagonal calculated from the work sizes (WS).**  
Deviazione massima ammissibile della curvatura del centro, in % oppure mm, in rapporto alla diagonale calcolata secondo le dimensioni di fabbricazione (WS).
- e.c. **The maximum permissible deviation from edge curvature, in % or mm, related to the corresponding work sizes (WS).**  
Deviazione massima ammissibile della curvatura dello spigolo, in % oppure mm, in rapporto alle dimensioni di fabbricazione (WS) corrispondenti.
- w. **The maximum permissible deviation from warpage, in % or mm, related to diagonal calculated from the work sizes (WS).**  
Deviazione massima ammissibile dello svergolamento, in % oppure mm, in rapporto alla diagonale calcolata secondo le dimensioni di fabbricazione (WS).
- (1) **Determination of slip resistance of pedestrian surfaces; it does not cover sports surfaces and road surfaces for vehicles (skid resistance).**  
Determinazione della resistenza allo scivolamento delle superfici pedonabili; non si applica alle pavimentazioni sportive ed alle pavimentazioni stradali veicolari.
- (2) **Anti-slip performance is guaranteed at the time of delivery of the product.**  
Le prestazioni anti-slip vengono garantite al momento della consegna del prodotto.
- (3) **However, tiles with a DCOF of 0.42 or greater are not necessarily suitable for all projects. The specifier shall determine tiles appropriate for specific project conditions, considering by way of example, but not in limitation, type of use, traffic, expected contaminants, expected maintenance, expected wear, and manufacturers' guidelines and recommendations.**  
Per maggiori dettagli, please refer to outdoor design general catalogue. Per maggiori informazioni riferirsi al catalogo generale Outdoor Design.
- (4) **For further details, please refer to outdoor design general catalogue.**
- (5) **Only for products with 20 mm thickness. Solo per prodotti a 20mm di spessore.**

## TECHNICAL SPECIFICATION SYMBOLS

			<b>Length and width</b> / Lunghezza e larghezza / Longuer et largeur / Länge und Breite / Longitud y anchura / Размеры сторон (*)
			<b>Thickness</b> / Spessore / Epaisseur / Stärke / Grosor / Толщина (**)
			<b>Straightness of sides</b> / Rettilineità degli spigoli Rectitude des arêtes / Kantengeradheit / Rectilineidad de las aristas / Кривизна сторон (***)
			<b>Rectangularity</b> / Ortogonalità / Orthogonalite / Rechtwinkligkeit / Ortogonalidad / Косоугольность (****) <b>(Measurement only on short edges when L/l ≥ 3)</b> (Misurazione da condurre solo sui lati corti quando L/l ≥ 3) (Ne mesurez que les côtés courts lorsque L/l ≥ 3) (Messung nur an den kurzen Seiten, wenn L/l ≥ 3) (Medir solo en los lados cortos cuando L/l ≥ 3) (Измерение проводится только на короткой грани, когда L/l ≥ 3)
			<b>Surface flatness</b> / Planarità Planimetrie / Ebenflächigkeit / Planaridad / Кривизна лицевой поверхности
			c.c. e.c. ws.
			<b>Water absorption (in % by mass)</b> / Massa d'acqua assorbita (come % della massa) Masse d'eau absorbée (en % de la masse) / Aufgenommene Wassermasse (in % der Masse) / Peso de agua absorbida (como % de la masa) / Водопоглощение (% от массы)
			<b>Breaking strength</b> / Sforzo di rottura Force de rupture / Bruchlast / Esfuerzo de ruptura / Усилие на излом
			<b>Modulus of rupture</b> / Resistenza alla flessione Résistance à la flexion / Biegefestigkeit / Resistencia a la flexión / Устойчивость к изгибу
			<b>Bending strength and breaking load</b> / Resistenza a flessione e al carico di rottura Résistance à la flexion et à la charge de rupture / Biege- und Bruchfestigkeit (4)(5) Extraordinaria resistencia a la flexión y a la carga de rotura / Предел прочности при изгибе и разрушающая нагрузка
			<b>Impact resistance, as coefficient of restitution</b> / Resistenza all'impatto, espresso come coefficiente di restituzione Résistance au choc, par mesurage du coefficient de restitution / Schlagzähigkeit, ausgedrückt als Restitutionskoeffizient Resistencia al impacto, expresada como coeficiente de restitución / Ударпрочность, выраженная коэффициентом восстановления
			<b>MOHS hardness</b> / Durezza MOHS Dureté Mohs / Ritzhärte nach Mohs / Dureza Mohs / Твёрдость по Моосу
			<b>Resistance to deep abrasion of unglazed tiles (removed volume)</b> Resistenza all'abrasione profonda delle piastrelle non smaltate (volume materiale asportato) Résistance à l'abrasion profonde des carreaux non émaillés (volume du matériau retiré) Widerstand gegen Tiefenverschleiß von unglasierten Fliesen (Materialabtrag bzw. Volumenverlust) Resistencia a la abrasión profunda de las baldosas no esmaltadas (volumen material extraído) Стойкость к глубокому истиранию неглазурованных плиток (объем удаленного материала)
			<b>Coefficient of thermal linear expansion</b> / Coefficiente di dilatazione termica lineare Coefficient de dilatation thermique linéique / Lineare thermische Dehnung Coeficiente de dilatación térmica lineal / Коэффициент линейного расширения
			<b>Thermal shock resistance</b> / Resistenza agli sbalzi termici Résistance aux écarts de température / Temperaturwechselbeständigkeit Resistencia a los cambios de temperatura / Устойчивость к перепаду температур
			<b>Moisture expansion (in mm/m)</b> / Dilatazione all'umidità (in mm/m) Dilatation à l'humidité (en mm/m) / Feuchtigkeitsausdehnung (in mm/m) Dilatación por la humedad (en mm/m) / Расширение под воздействием влаги (в мм/м)
			<b>FROST resistance</b> / Resistenza al gelo Résistance aux gel / Frostbeständigkeit / Resistencia a las heladas / Морозоустойчивость
			<b>Bond strength/adhesion for improved cementitious adhesives</b> / Adesione a trazione con adesivi cementizi migliorati Adhérence par traction avec des ciments-colle améliorés / Scherfestigkeit mit verbesserten zementhaltigen Klebern Adherencia a tracción con adhesivos cementosos mejorados Прочность на растяжение при приклеивании улучшенными цементными клеями
			<b>Reaction to fire</b> / Reazione al fuoco Réaction au feu / Brandverhalten / Reacción al fuego / Огнестойкость
			<b>Resistance to household chemicals and swimming pool salts</b> Resistenza ai prodotti chimici di uso domestico ed agli additivi per piscina Résistance aux produits chimiques à usage domestique et aux adjuvants pour piscine Beständigkeit gegen Haushaltschemikalien und Badewasserzusätze Resistencia a los productos químicos de uso doméstico / Стойкость к химикатам, используемым в быту и для бассейнов
			<b>Resistance to low concentrations of acids and alkalis</b> / Resistenza a basse concentrazioni di ACIDI e ALCALI Résistance aux acides et aux alcalis à basse concentration / Beständigkeit gegen niedrigkonzentrierte Säuren und Laugen Resistencia a los ácidos y bases de baja concentración / Сопротивление кислотам и щелочам низкой концентрации
			<b>Resistance to high concentrations of acids and alkalis</b> / Resistenza ad alte concentrazioni di ACIDI e ALCALI Résistance aux acides et aux alcalis à haute concentration / Beständigkeit gegen hochkonzentrierte Säuren und Laugen Resistencia a los ácidos y bases de alta concentración / Сопротивление кислотам и щелочам высокой концентрации
			<b>Resistance to STAINING for unglazed tiles</b> / Resistenza alle MACCHIE per piastrelle non smaltate Résistance aux taches pour carreaux non émaillés / Widerstand gegen Fleckenbildung für unglasierte Fliesen / Resistencia a las manchas para azulejos no esmaltados / Устойчивость к загрязнению, для неглазурованных плиток
			<b>Shod Ramp Test</b> / Metodo della rampa "calzato" / Test de la rampe « chaussé » / Rampenmethode mit Schuhen Método de la rampa "calzado" / Метод наклонной плоскости (в обуви)
			<b>Barefoot Ramp Test</b> / Metodo della rampa a piedi nudi / Test de la rampe à pieds nus / Rampenmethode barfuß Método de la rampa a pies descalzos / Метод наклонной плоскости (босыми ногами) (1)(2)
			<b>Pendulum Friction Test</b> / Metodo del Pendolo Méthode du Pendule / Pendelmethode / Método del péndulo / Метод маятника (1)(2)
			<b>Coefficient of friction (COF)</b> / Coefficiente di attrito Coefficient de frottement / Reibungskoeffizient / Coeficiente de roce / Коэффициент трения (1)(2)
			<b>Dynamic coefficient of friction (DCOF)</b> / Coefficiente di attrito dinamico Coefficient de frottement dynamique / Dynamischer Reibungskoeffizient / Coeficiente de roce dinámico (1)(2)(3) Динамический коэффициент трения
			<b>Technical features</b> - Caratteristiche tecniche - Caractéristiques techniques - Technische Daten - Características técnicas - Технические характеристики

INDEX



PRODUCT  
FINDER



SURFACE  
RANGE



COMPANY



COLLECTIONS



LARGE SIZES



TECHNICAL  
SPECIFICATIONS



TECHNICAL FEATURE  
PORCELAIN TILES

		Requirements for nominal size N Requisiti per dimensione nominale N			AIX				AXI	
		7 cm ≤ N < 15 cm (mm)	N ≥ 15 cm (%) (mm)		Matte	Grip	Textured	Outdoor ± 20mm	Matte	
Regularity characteristics	Length and width Lunghezza e larghezza	± 0,9 (*) Non-rect. ± 0,4 (*) Rect.	± 0,6 (*) Non-rect. ± 0,3 (*) Rect.	± 2,0 (*) Non-rect. ± 1,0 (*) Rect.	Suitable for Conforme	Suitable for Conforme	Suitable for Conforme	Suitable for Conforme	Suitable for Conforme	
	Thickness Spessore	± 0,5 (**)	± 5 (**)	± 0,5 (**)	Suitable for Conforme	Suitable for Conforme	Suitable for Conforme	Suitable for Conforme	Suitable for Conforme	
	Straightness of sides Rettilinearità degli spigoli	± 0,8 (***) Non-rect. ± 0,4 (***) Rect.	± 0,5 (***) Non-rect. ± 0,3 (***) Rect.	± 1,5 (***) Non-rect. ± 0,8 (***) Rect.	Suitable for Conforme	Suitable for Conforme	Suitable for Conforme	Suitable for Conforme	Suitable for Conforme	
Structural characteristics	Rectangularity (Measurement only on short edges when L/1 ≥ 3) Ortogonalità (Misurazione da condurre solo sui lati corti quando L/1 ≥ 3)	± 0,8 (****) Non-rect. ± 0,4 (****) Rect.	± 0,5 (****) Non-rect. ± 0,3 (****) Rect.	± 2,0 (****) Non-rect. ± 1,5 (****) Rect.	Suitable for Conforme	Suitable for Conforme	Suitable for Conforme	Suitable for Conforme	Suitable for Conforme	
	Surface flatness Planarità	c.c. ± 0,8 Non-rect. c.c. ± 0,6 Rect. e.c. ± 0,8 Non-rect. e.c. ± 0,6 Rect. w. ± 0,8 Non-rect. w. ± 0,6 Rect.	c.c. ± 0,5 Non-rect. c.c. ± 0,4 Rect. e.c. ± 0,5 Non-rect. e.c. ± 0,4 Rect. w. ± 0,5 Non-rect. w. ± 0,4 Rect.	c.c. ± 2,0 Non-rect. c.c. ± 1,8 Rect. e.c. ± 2,0 Non-rect. e.c. ± 1,8 Rect. w. ± 2,0 Non-rect. w. ± 1,8 Rect.	Suitable for Conforme	Suitable for Conforme	Not applicable to strong structures Non applicabile a strutturati forti		Suitable for Conforme	
	Water absorption (in % by mass) Massa d'acqua assorbita (come % della massa)	E <sub>s</sub> ≤ 0,5% Individual max 0,6% E <sub>s</sub> ≤ 0,5% Valore max singolo 0,6%			≤ 0,1 %	≤ 0,1 %	≤ 0,1 %	≤ 0,1 %	≤ 0,1 %	
Bulk mechanical characteristics	Breaking strength Sforzo di rottura	Requirement ANSI A137.1 Water Absorption Max ≤ 0,5%			≤ 0,5 %	≤ 0,5 %	≤ 0,5 %	≤ 0,5 %	≤ 0,5 %	
	Modulus of rupture Resistenza alla flessione	S ≥ 700N (for thickness < 7,5 mm - per spessore < 7,5 mm) S ≥ 1300N (for thickness ≥ 7,5 mm - per spessore ≥ 7,5 mm)			S ≥ 1500 N	S ≥ 1500 N	S ≥ 1500 N	S ≥ 10000 N	S ≥ 2000 N	
Surface mechanical characteristics	Bending strength and breaking load Resistenza a flessione e al carico di rottura (4)(5)	R ≥ 35 N/mm <sup>2</sup>			R ≥ 40 N/mm <sup>2</sup>	R ≥ 40 N/mm <sup>2</sup>	R ≥ 40 N/mm <sup>2</sup>	R ≥ 45 N/mm <sup>2</sup>	R ≥ 40 N/mm <sup>2</sup>	
	Impact resistance, as coefficient of restitution Resistenza all'impatto, espresso come coefficiente di restituzione	Declared value Valore dichiarato			≥ 0,55	≥ 0,55	≥ 0,55	≥ 0,55	≥ 0,55	
Thermal and hygrometric characteristics	Mohs hardness Durezza Mohs	-			6	8	8	8	6	
	Resistance to deep abrasion of unglazed tiles (removed volume) Resistenza all'abrasione profonda delle piastrelle non smaltate (volume materiale asportato)	ISO 10545-6			≤ 175 mm <sup>3</sup>	≤ 150 mm <sup>3</sup>	≤ 150 mm <sup>3</sup>	≤ 150 mm <sup>3</sup>	≤ 150 mm <sup>3</sup>	
Physical properties	Coefficient of thermal linear expansion Coefficiente di dilatazione termica lineare	ISO 10545-8			Declared value Valore dichiarato	≤ 7 MK <sup>-1</sup>	≤ 7 MK <sup>-1</sup>	≤ 7 MK <sup>-1</sup>	≤ 7 MK <sup>-1</sup>	
	Thermal shock resistance Resistenza agli sbalzi termici	ISO 10545-9			Pass according to EN ISO 10545-1 Test superato in accordo con ISO 10545-1	Resistant Resiste	Resistant Resiste	Resistant Resiste	Resistant Resiste	
	Moisture expansion (in mm/m) Dilatazione all'umidità (in mm/m)	ISO 10545-10			Declared value Valore dichiarato	≤ 0,01% (0,1mm/m)	≤ 0,01% (0,1mm/m)	≤ 0,01% (0,1mm/m)	≤ 0,01% (0,1mm/m)	
	Frost resistance Resistenza al gelo	ISO 10545-12			Pass according to EN ISO 10545-1 Test superato in accordo con ISO 10545-1	Resistant Resiste	Resistant Resiste	Resistant Resiste	Resistant Resiste	
Chemical characteristics	Bond strength/adhesion for improved cementitious adhesives Adesione a trazione con adesivi cementizi migliorati	EN 1348			Declared value Valore dichiarato	≥ 1,0 N/mm <sup>2</sup> (Class C2 - EN 12004)	≥ 1,0 N/mm <sup>2</sup> (Class C2 - EN 12004)	≥ 1,0 N/mm <sup>2</sup> (Class C2 - EN 12004)	≥ 1,0 N/mm <sup>2</sup> (Class C2 - EN 12004)	
	Reaction to fire Reazione al fuoco	-			Class A1 or A1 <sub>fl</sub> Classe A1 oppure A1 <sub>fl</sub>	A1 - A1 <sub>fl</sub>	A1 - A1 <sub>fl</sub>	A1 - A1 <sub>fl</sub>	A1 - A1 <sub>fl</sub>	
Safety characteristics (1)(2)	Resistance to household chemicals and swimming pool salts Resistenza ai prodotti chimici di uso domestico ed agli additivi per piscina	ISO 10545-13			Minimum Class B Classe minima B	A	A	A	A	
	Resistance to low concentrations of acids and alkalis Resistenza a basse concentrazioni di acidi e alcali	-			Declared Class Classe dichiarata	LA	LA	LA	LA	
	Resistance to high concentrations of acids and alkalis Resistenza ad alte concentrazioni di acidi e alcali	-			Declared Class Classe dichiarata	HA	HA	HA	HA	
Safety characteristics (1)(2)	Resistance to staining, for unglazed tiles Resistenza alle macchie per piastrelle non smaltate	ISO 10545-14			Declared Class Classe dichiarata	5	5	5	5	
	Shod Ramp Test Metodo della rampa "calzato"	DIN 51130			Declared value Valore dichiarato	R10	R11	R11	R10	
	Barefoot Ramp Test Metodo della rampa a piedi nudi	DIN 51097			Declared value Valore dichiarato	A+B	A+B+C	A+B+C	A+B	
	Pendulum Friction Test Metodo del Pendolo	BS 7976	PTV ≥ 36 classifies the surface as "low slip risk"			≥ 36 Dry ≥ 36 Wet	≥ 36 Dry ≥ 36 Wet	≥ 36 Dry ≥ 36 Wet	≥ 36 Dry ≥ 36 Wet	≥ 36 Dry ≥ 36 Wet
		AS 4586	Declared Classification of the new pedestrian surface materials according to the Pendulum Test			Class P3	Class P4	Class P4	Class P4	Class P3
	Coefficient of friction (COF) Coefficiente di attrito	UNE-ENV 12633 UNE 419012017 EX	Declared value Valore dichiarato			Class C2	Class C3	Class C3	Class C3	Class C2
B.C.R.A. Rep. CEC/81		D.M. 236/89 del 14/06/89 μ > 0,40 per elemento scivolante cuoio su pavimentazione asciutta μ > 0,40 per elemento scivolante gomma dura su pavimentazione bagnata			> 0,40 Asciutto > 0,40 Bagnato	> 0,40 Asciutto > 0,40 Bagnato	> 0,40 Asciutto > 0,40 Bagnato	> 0,40 Asciutto > 0,40 Bagnato	> 0,40 Asciutto > 0,40 Bagnato	
Dynamic coefficient of friction (DCOF) Coefficiente di attrito dinamico	ANSI A137.1			ANSI A137.1-2017 Requires a minimum value of 0.42 for level interior space expected to be walked upon when wet. (3)	> 0,42 Wet	> 0,42 Wet	> 0,42 Wet	> 0,42 Wet		

AXI		BLAZE					BOOST				BOOST MIX			
Textured	Outdoor ± 20mm	Matte	Matte ± 6mm	Polished	Grip	Outdoor ± 20mm	Matte	Matte ± 6mm	Grip	Outdoor ± 20mm	Matte ± 9 mm	Matte ± 6 mm	Grip ± 9 mm	Outdoor ± 20mm
Suitable for Conforme	Suitable for Conforme	Suitable for Conforme	Suitable for Conforme	Suitable for Conforme	Suitable for Conforme	Suitable for Conforme	Suitable for Conforme	Suitable for Conforme	Suitable for Conforme	Suitable for Conforme	Suitable for Conforme	Suitable for Conforme	Suitable for Conforme	Suitable for Conforme
Suitable for Conforme	Suitable for Conforme	Suitable for Conforme	Suitable for Conforme	Suitable for Conforme	Suitable for Conforme	Suitable for Conforme	Suitable for Conforme	Suitable for Conforme	Suitable for Conforme	Suitable for Conforme	Suitable for Conforme	Suitable for Conforme	Suitable for Conforme	Suitable for Conforme
Suitable for Conforme	Suitable for Conforme	Suitable for Conforme	Suitable for Conforme	Suitable for Conforme	Suitable for Conforme	Suitable for Conforme	Suitable for Conforme	Suitable for Conforme	Suitable for Conforme	Suitable for Conforme	Suitable for Conforme	Suitable for Conforme	Suitable for Conforme	Suitable for Conforme
Suitable for Conforme	Suitable for Conforme	Suitable for Conforme	Suitable for Conforme	Suitable for Conforme	Suitable for Conforme	Suitable for Conforme	Suitable for Conforme	Suitable for Conforme	Suitable for Conforme	Suitable for Conforme	Suitable for Conforme	Suitable for Conforme	Suitable for Conforme	Suitable for Conforme
Not applicable to strong structures Non applicabile a strutturati forti		Suitable for Conforme	Suitable for Conforme	Suitable for Conforme	Suitable for Conforme	Suitable for Conforme	Suitable for Conforme	Suitable for Conforme	Suitable for Conforme	Suitable for Conforme	Suitable for Conforme	Suitable for Conforme	Suitable for Conforme	Suitable for Conforme
≤ 0,1 %	≤ 0,1 %	≤ 0,1 %	≤ 0,1 %	≤ 0,1 %	≤ 0,1 %	≤ 0,1 %	≤ 0,1 %	≤ 0,1 %	≤ 0,1 %	≤ 0,1 %	≤ 0,1 %	≤ 0,1 %	≤ 0,1 %	≤ 0,1 %
≤ 0,5 %	≤ 0,5 %	≤ 0,5 %	≤ 0,5 %	≤ 0,5 %	≤ 0,5 %	≤ 0,5 %	≤ 0,5 %	≤ 0,5 %	≤ 0,5 %	≤ 0,5 %	≤ 0,5 %	≤ 0,5 %	≤ 0,5 %	≤ 0,5 %
S ≥ 2000 N	S ≥ 10000 N	S ≥ 1500 N	S ≥ 1000 N	S ≥ 1500 N	S ≥ 1500 N	S ≥ 10000 N	S ≥ 1500 N	S ≥ 1000 N	S ≥ 1500 N	S ≥ 10000 N	S ≥ 1500 N	S ≥ 1000 N	S ≥ 1500 N	S ≥ 10000 N
R ≥ 40 N/mm <sup>2</sup>	R ≥ 45 N/mm <sup>2</sup>	R ≥ 40 N/mm <sup>2</sup>	R ≥ 40 N/mm <sup>2</sup>	R ≥ 40 N/mm <sup>2</sup>	R ≥ 40 N/mm <sup>2</sup>	R ≥ 45 N/mm <sup>2</sup>	R ≥ 40 N/mm <sup>2</sup>	R ≥ 40 N/mm <sup>2</sup>	R ≥ 40 N/mm <sup>2</sup>	R ≥ 45 N/mm <sup>2</sup>	R ≥ 40 N/mm <sup>2</sup>	R ≥ 40 N/mm <sup>2</sup>	R ≥ 40 N/mm <sup>2</sup>	R ≥ 45 N/mm <sup>2</sup>
-	≥ T11 60x60	≥ U4 45x90	-	-	-	≥ T11 120x120 60x60	-	-	-	≥ T11 120x120 60x60	≥ U11 90x90	≥ U4 60x120	-	≥ T11 120x120 60x60
≥ 0,55	≥ 0,55	≥ 0,55	≥ 0,55	≥ 0,55	≥ 0,55	≥ 0,55	≥ 0,55	≥ 0,55	≥ 0,55	≥ 0,55	≥ 0,55	≥ 0,55	≥ 0,55	≥ 0,55
8	8	6	6	5	8	8	6	6	8	8	6	6	8	8
≤ 150 mm <sup>3</sup>	≤ 150 mm <sup>3</sup>	≤ 150 mm <sup>3</sup>	≤ 150 mm <sup>3</sup>	≤ 150 mm <sup>3</sup>	≤ 150 mm <sup>3</sup>	≤ 150 mm <sup>3</sup>	≤ 150 mm <sup>3</sup>	≤ 150 mm <sup>3</sup>	≤ 150 mm <sup>3</sup>	≤ 150 mm <sup>3</sup>	≤ 150 mm <sup>3</sup>	≤ 150 mm <sup>3</sup>	≤ 150 mm <sup>3</sup>	≤ 150 mm <sup>3</sup>
≤ 7 MK <sup>-1</sup>	≤ 7 MK <sup>-1</sup>	≤ 7 MK <sup>-1</sup>	≤ 7 MK <sup>-1</sup>	≤ 7 MK <sup>-1</sup>	≤ 7 MK <sup>-1</sup>	≤ 7 MK <sup>-1</sup>	≤ 7 MK <sup>-1</sup>	≤ 7 MK <sup>-1</sup>	≤ 7 MK <sup>-1</sup>	≤ 7 MK <sup>-1</sup>	≤ 7 MK <sup>-1</sup>	≤ 7 MK <sup>-1</sup>	≤ 7 MK <sup>-1</sup>	≤ 7 MK <sup>-1</sup>
Resistant Resiste	Resistant Resiste	Resistant Resiste	Resistant Resiste	Resistant Resiste	Resistant Resiste	Resistant Resiste	Resistant Resiste	Resistant Resiste	Resistant Resiste	Resistant Resiste	Resistant Resiste	Resistant Resiste	Resistant Resiste	Resistant Resiste
≤ 0,01% (0,1mm/m)	≤ 0,01% (0,1mm/m)	≤ 0,01% (0,1mm/m)	≤ 0,01% (0,1mm/m)	≤ 0,01% (0,1mm/m)	≤ 0,01% (0,1mm/m)	≤ 0,01% (0,1mm/m)	≤ 0,01% (0,1mm/m)	≤ 0,01% (0,1mm/m)	≤ 0,01% (0,1mm/m)	≤ 0,01% (0,1mm/m)	≤ 0,01% (0,1mm/m)	≤ 0,01% (0,1mm/m)	≤ 0,01% (0,1mm/m)	≤ 0,01% (0,1mm/m)
Resistant Resiste	Resistant Resiste	Resistant Resiste	Resistant Resiste	Resistant Resiste	Resistant Resiste	Resistant Resiste	Resistant Resiste	Resistant Resiste	Resistant Resiste	Resistant Resiste	Resistant Resiste	Resistant Resiste	Resistant Resiste	Resistant Resiste
≥ 1,0 N/mm <sup>2</sup> (Class C2 - EN 12004)	≥ 1,0 N/mm <sup>2</sup> (Class C2 - EN 12004)	≥ 1,0 N/mm <sup>2</sup> (Class C2 - EN 12004)	≥ 1,0 N/mm <sup>2</sup> (Class C2 - EN 12004)	≥ 1,0 N/mm <sup>2</sup> (Class C2 - EN 12004)	≥ 1,0 N/mm <sup>2</sup> (Class C2 - EN 12004)	≥ 1,0 N/mm <sup>2</sup> (Class C2 - EN 12004)	≥ 1,0 N/mm <sup>2</sup> (Class C2 - EN 12004)	≥ 1,0 N/mm <sup>2</sup> (Class C2 - EN 12004)	≥ 1,0 N/mm <sup>2</sup> (Class C2 - EN 12004)	≥ 1,0 N/mm <sup>2</sup> (Class C2 - EN 12004)	≥ 1,0 N/mm <sup>2</sup> (Class C2 - EN 12004)	≥ 1,0 N/mm <sup>2</sup> (Class C2 - EN 12004)	≥ 1,0 N/mm <sup>2</sup> (Class C2 - EN 12004)	≥ 1,0 N/mm <sup>2</sup> (Class C2 - EN 12004)
A1 - A1 <sub>fl</sub>	A1 - A1 <sub>fl</sub>	A1 - A1 <sub>fl</sub>	A1 - A1 <sub>fl</sub>	A1 - A1 <sub>fl</sub>	A1 - A1 <sub>fl</sub>	A1 - A1 <sub>fl</sub>	A1 - A1 <sub>fl</sub>	A1 - A1 <sub>fl</sub>	A1 - A1 <sub>fl</sub>	A1 - A1 <sub>fl</sub>	A1 - A1 <sub>fl</sub>	A1 - A1 <sub>fl</sub>	A1 - A1 <sub>fl</sub>	A1 - A1 <sub>fl</sub>
A	A	A	A	A	A	A	A	A	A	A	A	A	A	A
LA	LA	LA	LA	LA	LA	LA	LA	LA	LA	LA	LA	LA	LA	LA
HA	HA	HA	HA	-	HA	HA	HA	HA	HA	HA	HA	HA	HA	HA
5	5	5	5	5	5	5	5	5	5	5	5	5	5	5
R11	R11	R10	R9	■	R11	R11	R10	R9	R11	R11	R10	R9	R11	R11
A+B+C	A+B+C	A+B	A	0	A+B+C	A+B+C	A+B	A	A+B+C	A+B+C	A+B	A	A+B+C	A+B+C
≥ 36 Dry ≥ 36 Wet	≥ 36 Dry ≥ 36 Wet	≥ 36 Dry ≥ 36 Wet	(●)	≥ 36 Dry ≤ 24 Wet	≥ 36 Dry ≥ 36 Wet	≥ 36 Dry ≥ 36 Wet	≥ 36 Dry ≥ 36 Wet	(●)	≥ 36 Dry ≥ 36 Wet	≥ 36 Dry ≥ 36 Wet	≥ 36 Dry ≥ 36 Wet	(●)	≥ 36 Dry ≥ 36 Wet	≥ 36 Dry ≥ 36 Wet
Class P4	Class P4	Class P3	(●●)	-	Class P4	Class P4	Class P3	(●●)	Class P4	Class P4	Class P3	(●●)	Class P4	Class P4
Class C3	Class C3	Class C2	(●●●)	-	Class C3	Class C3	Class C2	(●●●)	Class C3	Class C3	Class C2	(●●●)	Class C3	Class C3
> 0,40 Asciutto > 0,40 Bagnato	> 0,40 Asciutto > 0,40 Bagnato	> 0,40 Asciutto > 0,40 Bagnato	> 0,40 Asciutto > 0,40 Bagnato	> 0,40 Asciutto > 0,40 Bagnato	> 0,40 Asciutto > 0,40 Bagnato	> 0,40 Asciutto > 0,40 Bagnato	> 0,40 Asciutto > 0,40 Bagnato	> 0,40 Asciutto > 0,40 Bagnato	> 0,40 Asciutto > 0,40 Bagnato	> 0,40 Asciutto > 0,40 Bagnato	> 0,40 Asciutto > 0,40 Bagnato	> 0,40 Asciutto > 0,40 Bagnato	> 0,40 Asciutto > 0,40 Bagnato	> 0,40 Asciutto > 0,40 Bagnato
> 0,42 Wet	> 0,42 Wet	> 0,42 Wet	> 0,42 Wet	✘	> 0,42 Wet	> 0,42 Wet	> 0,42 Wet	> 0,42 Wet	> 0,42 Wet	> 0,42 Wet	> 0,42 Wet	> 0,42 Wet	> 0,42 Wet	> 0,42 Wet



TECHNICAL FEATURE  
PORCELAIN TILES

			Requirements for nominal size N Requisiti per dimensione nominale N			BOOST NATURAL			
			7 cm ≤ N < 15 cm (mm)	N ≥ 15 cm (%) (mm)		Matte ± 9 mm (1)	Matte ± 6 mm (1)	Grip ± 9 mm	Outdoor ± 20mm
Regularity characteristics	Length and width Lunghezza e larghezza	ISO 10545-2	± 0,9 (*) Non-rect. ± 0,4 (*) Rect.	± 0,6 (*) Non-rect. ± 0,3 (*) Rect.	± 2,0 (*) Non-rect. ± 1,0 (*) Rect.	Suitable for Conforme	Suitable for Conforme	Suitable for Conforme	Suitable for Conforme
			± 0,5 (**)	± 5 (**)	± 0,5 (**)	Suitable for Conforme	Suitable for Conforme	Suitable for Conforme	Suitable for Conforme
			± 0,8 (***) Non-rect. ± 0,4 (***) Rect.	± 0,5 (***) Non-rect. ± 0,3 (***) Rect.	± 1,5 (***) Non-rect. ± 0,8 (***) Rect.	Suitable for Conforme	Suitable for Conforme	Suitable for Conforme	Suitable for Conforme
	Rectangularity (Measurement only on short edges when L/1 ≥ 3) Ortogonalità (Misurazione da condurre solo sui lati corti quando L/1 ≥ 3)	± 0,8 (****) Non-rect. ± 0,4 (****) Rect.	± 0,5 (****) Non-rect. ± 0,3 (****) Rect.	± 2,0 (****) Non-rect. ± 1,5 (****) Rect.	Suitable for Conforme	Suitable for Conforme	Suitable for Conforme	Suitable for Conforme	
Surface flatness Planarità	ISO 10545-2	c.c. ± 0,8 Non-rect. c.c. ± 0,6 Rect.	c.c. ± 0,5 Non-rect. c.c. ± 0,4 Rect.	c.c. ± 2,0 Non-rect. c.c. ± 1,8 Rect.	Suitable for Conforme	Suitable for Conforme	Suitable for Conforme	Suitable for Conforme	
		e.c. ± 0,8 Non-rect. e.c. ± 0,6 Rect.	e.c. ± 0,5 Non-rect. e.c. ± 0,4 Rect.	e.c. ± 2,0 Non-rect. e.c. ± 1,8 Rect.					
		w. ± 0,8 Non-rect. w. ± 0,6 Rect.	w. ± 0,5 Non-rect. w. ± 0,4 Rect.	w. ± 2,0 Non-rect. w. ± 1,8 Rect.					
Structural characteristics	Water absorption (in % by mass) Massa d'acqua assorbita (come % della massa)	ISO 10545-3	E <sub>s</sub> ≤ 0,5% Individual max 0,6% E <sub>s</sub> ≤ 0,5% Valore max singolo 0,6%			≤ 0,1 %	≤ 0,1 %	≤ 0,1 %	≤ 0,1 %
		ASTM C373-18	Requirement ANSI A137.1 Water Absorption Max ≤ 0,5%			≤ 0,5 %	≤ 0,5 %	≤ 0,5 %	≤ 0,5 %
Bulk mechanical characteristics	Breaking strength Sforzo di rottura	ISO 10545-4	S ≥ 700N (for thickness < 7,5 mm - per spessore < 7,5 mm) S ≥ 1300N (for thickness ≥ 7,5 mm - per spessore ≥ 7,5 mm)			S ≥ 1500 N	S ≥ 1000 N	S ≥ 1500 N	S ≥ 10000 N
	Modulus of rupture Resistenza alla flessione		R ≥ 35 N/mm <sup>2</sup>			R ≥ 40 N/mm <sup>2</sup>	R ≥ 40 N/mm <sup>2</sup>	R ≥ 40 N/mm <sup>2</sup>	R ≥ 45 N/mm <sup>2</sup>
	Bending strength and breaking load Resistenza a flessione e al carico di rottura (4)(5)	EN 1339 Annex F	-			-	-	-	≥ T11 120x120 60x60
	Impact resistance, as coefficient of restitution Resistenza all'impatto, espresso come coefficiente di restituzione	ISO 10545-5	Declared value Valore dichiarato			≥ 0,55	≥ 0,55	≥ 0,55	≥ 0,55
Surface mechanical characteristics	Mohs hardness Durezza Mohs	EN 101	-			6	6	8	8
	Resistance to deep abrasion of unglazed tiles (removed volume) Resistenza all'abrasione profonda delle piastrelle non smaltate (volume materiale asportato)	ISO 10545-6	≤ 175 mm <sup>3</sup>			≤ 150 mm <sup>3</sup> (2)	≤ 150 mm <sup>3</sup> (2)	≤ 150 mm <sup>3</sup>	≤ 150 mm <sup>3</sup>
Thermal and hygrometric characteristics	Coefficient of thermal linear expansion Coefficiente di dilatazione termica lineare	ISO 10545-8	Declared value Valore dichiarato			≤ 7 MK <sup>-1</sup>	≤ 7 MK <sup>-1</sup>	≤ 7 MK <sup>-1</sup>	≤ 7 MK <sup>-1</sup>
	Thermal shock resistance Resistenza agli sbalzi termici	ISO 10545-9	Pass according to EN ISO 10545-1 Test superato in accordo con ISO 10545-1			Resistant Resiste	Resistant Resiste	Resistant Resiste	Resistant Resiste
	Moisture expansion (in mm/m) Dilatazione all'umidità (in mm/m)	ISO 10545-10	Declared value Valore dichiarato			≤ 0,01% (0,1mm/m)	≤ 0,01% (0,1mm/m)	≤ 0,01% (0,1mm/m)	≤ 0,01% (0,1mm/m)
	Frost resistance Resistenza al gelo	ISO 10545-12	Pass according to EN ISO 10545-1 Test superato in accordo con ISO 10545-1			Resistant Resiste	Resistant Resiste	Resistant Resiste	Resistant Resiste
Physical properties	Bond strength/adhesion for improved cementitious adhesives Adesione a trazione con adesivi cementizi migliorati	EN 1348	Declared value Valore dichiarato			≥ 10 N/mm <sup>2</sup> (Class C2 - EN 12004)	≥ 10 N/mm <sup>2</sup> (Class C2 - EN 12004)	≥ 10 N/mm <sup>2</sup> (Class C2 - EN 12004)	≥ 10 N/mm <sup>2</sup> (Class C2 - EN 12004)
	Reaction to fire Reazione al fuoco	-	Class A1 or A1 <sub>f</sub> Classe A1 oppure A1 <sub>f</sub>			A1 - A1 <sub>f</sub>	A1 - A1 <sub>f</sub>	A1 - A1 <sub>f</sub>	A1 - A1 <sub>f</sub>
Chemical characteristics	Resistance to household chemicals and swimming pool salts Resistenza ai prodotti chimici di uso domestico ed agli additivi per piscina	ISO 10545-13	Minimum Class B Classe minima B			A	A	A	A
	Resistance to low concentrations of acids and alkalis Resistenza a basse concentrazioni di acidi e alcali		Declared Class Classe dichiarata			LA	LA	LA	LA
	Resistance to high concentrations of acids and alkalis Resistenza ad alte concentrazioni di acidi e alcali		Declared Class Classe dichiarata			HA	HA	HA	HA
	Resistance to staining, for unglazed tiles Resistenza alle macchie per piastrelle non smaltate	ISO 10545-14	Declared Class Classe dichiarata			5	5	5	5
Safety characteristics (1)(2)	Shod Ramp Test Metodo della rampa "calzato"	DIN 51130	Declared value Valore dichiarato			R10	R9	R11	R11
	Barefoot Ramp Test Metodo della rampa a piedi nudi	DIN 51097	Declared value Valore dichiarato			A+B	A	A+B+C	A+B+C
	Pendulum Friction Test Metodo del Pendolo	BS 7976	PTV ≥ 36 classifies the surface as "low slip risk"			≥ 36 Dry ≥ 36 Wet	●	≥ 36 Dry ≥ 36 Wet	≥ 36 Dry ≥ 36 Wet
		AS 4586	Declared Classification of the new pedestrian surface materials according to the Pendulum Test			Class P3	●●	Class P4	Class P4
		UNE-ENV 12633 UNE 41901:2017 EX	Declared value Valore dichiarato			Class C2	●●●	Class C3	Class C3
	Coefficient of friction (COF) Coefficiente di attrito	B.C.R.A. Rep. CEC/81	D. M. 236/89 del 14/06/89 μ>0,40 per elemento scivolante cuoio su pavimentazione asciutta μ>0,40 per elemento scivolante gomma dura su pavimentazione bagnata			> 0,40 Asciutto > 0,40 Bagnato	> 0,40 Asciutto > 0,40 Bagnato	> 0,40 Asciutto > 0,40 Bagnato	> 0,40 Asciutto > 0,40 Bagnato
Dynamic coefficient of friction (DCOF) Coefficiente di attrito dinamico	ANSI A137.1	ANSI A.1371-2017 Requires a minimum value of 0.42 for level interior space expected to be walked upon when wet. (3)			> 0,42 Wet	> 0,42 Wet	> 0,42 Wet	> 0,42 Wet	

Technical feature - Caratteristiche tecniche - Caractéristiques techniques - Technische Daten - Características técnicas - Технические характеристики

(1) Boost Natural Cobalt 'Glazed Porcelain Tiles'  
(2) PEI 3 (ISO 10545-7) Boost Natural Cobalt



BOOST PRO				BOOST STONE				BRAVE		
Matte	Matte ± 6mm	Grip	Outdoor ± 20mm	Matte ± 9 mm	Matte ± 6 mm	Grip ± 9 mm	Outdoor ± 20mm	Matte	Grip	Outdoor ± 20mm
Suitable for Conforme	Suitable for Conforme	Suitable for Conforme	Suitable for Conforme	Suitable for Conforme	Suitable for Conforme	Suitable for Conforme	Suitable for Conforme	Suitable for Conforme	Suitable for Conforme	Suitable for Conforme
Suitable for Conforme	Suitable for Conforme	Suitable for Conforme	Suitable for Conforme	Suitable for Conforme	Suitable for Conforme	Suitable for Conforme	Suitable for Conforme	Suitable for Conforme	Suitable for Conforme	Suitable for Conforme
Suitable for Conforme	Suitable for Conforme	Suitable for Conforme	Suitable for Conforme	Suitable for Conforme	Suitable for Conforme	Suitable for Conforme	Suitable for Conforme	Suitable for Conforme	Suitable for Conforme	Suitable for Conforme
Suitable for Conforme	Suitable for Conforme	Suitable for Conforme	Suitable for Conforme	Suitable for Conforme	Suitable for Conforme	Suitable for Conforme	Suitable for Conforme	Suitable for Conforme	Suitable for Conforme	Suitable for Conforme
Suitable for Conforme	Suitable for Conforme	Suitable for Conforme	Suitable for Conforme	Suitable for Conforme	Suitable for Conforme	Suitable for Conforme	Suitable for Conforme	Not applicable to 'strong' structures Non applicabile a strutturati forti		
≤ 0,1 %	≤ 0,1 %	≤ 0,1 %	≤ 0,1 %	≤ 0,1 %	≤ 0,1 %	≤ 0,1 %	≤ 0,1 %	≤ 0,1 %	≤ 0,1 %	≤ 0,1 %
≤ 0,5 %	≤ 0,5 %	≤ 0,5 %	≤ 0,5 %	≤ 0,5 %	≤ 0,5 %	≤ 0,5 %	≤ 0,5 %	≤ 0,5 %	≤ 0,5 %	≤ 0,5 %
S ≥ 1500 N	S ≥ 1000 N	S ≥ 1500 N	S ≥ 10000 N	S ≥ 1500 N	S ≥ 1000 N	S ≥ 1500 N	S ≥ 10000 N	S ≥ 1500 N	S ≥ 1500 N	S ≥ 10000 N
R ≥ 40 N/mm <sup>2</sup>	R ≥ 40 N/mm <sup>2</sup>	R ≥ 40 N/mm <sup>2</sup>	R ≥ 45 N/mm <sup>2</sup>	R ≥ 40 N/mm <sup>2</sup>	R ≥ 40 N/mm <sup>2</sup>	R ≥ 40 N/mm <sup>2</sup>	R ≥ 45 N/mm <sup>2</sup>	R ≥ 40 N/mm <sup>2</sup>	R ≥ 40 N/mm <sup>2</sup>	R ≥ 45 N/mm <sup>2</sup>
-	-	-	≥ T11 120x120 60x60	-	-	-	≥ T11 120x120 60x60	-	-	≥ T11 60x60
≥ 0,55	≥ 0,55	≥ 0,55	≥ 0,55	≥ 0,55	≥ 0,55	≥ 0,55	≥ 0,55	≥ 0,55	≥ 0,55	≥ 0,55
6	6	8	8	6	6	8	8	7	8	8
≤ 150 mm <sup>3</sup>	≤ 150 mm <sup>3</sup>	≤ 150 mm <sup>3</sup>	≤ 150 mm <sup>3</sup>	≤ 150 mm <sup>3</sup>	≤ 150 mm <sup>3</sup>	≤ 150 mm <sup>3</sup>	≤ 150 mm <sup>3</sup>	≤ 150 mm <sup>3</sup>	≤ 150 mm <sup>3</sup>	≤ 150 mm <sup>3</sup>
≤ 7 MK <sup>-1</sup>	≤ 7 MK <sup>-1</sup>	≤ 7 MK <sup>-1</sup>	≤ 7 MK <sup>-1</sup>	≤ 7 MK <sup>-1</sup>	≤ 7 MK <sup>-1</sup>	≤ 7 MK <sup>-1</sup>	≤ 7 MK <sup>-1</sup>	≤ 7 MK <sup>-1</sup>	≤ 7 MK <sup>-1</sup>	≤ 7 MK <sup>-1</sup>
Resistant Resiste	Resistant Resiste	Resistant Resiste	Resistant Resiste	Resistant Resiste	Resistant Resiste	Resistant Resiste	Resistant Resiste	Resistant Resiste	Resistant Resiste	Resistant Resiste
≤ 0,01% (0,1mm/m)	≤ 0,01% (0,1mm/m)	≤ 0,01% (0,1mm/m)	≤ 0,01% (0,1mm/m)	≤ 0,01% (0,1mm/m)	≤ 0,01% (0,1mm/m)	≤ 0,01% (0,1mm/m)	≤ 0,01% (0,1mm/m)	≤ 0,01% (0,1mm/m)	≤ 0,01% (0,1mm/m)	≤ 0,01% (0,1mm/m)
Resistant Resiste	Resistant Resiste	Resistant Resiste	Resistant Resiste	Resistant Resiste	Resistant Resiste	Resistant Resiste	Resistant Resiste	Resistant Resiste	Resistant Resiste	Resistant Resiste
≥ 10 N/mm <sup>2</sup> (Class C2 - EN 12004)	≥ 10 N/mm <sup>2</sup> (Class C2 - EN 12004)	≥ 10 N/mm <sup>2</sup> (Class C2 - EN 12004)	≥ 10 N/mm <sup>2</sup> (Class C2 - EN 12004)	≥ 10 N/mm <sup>2</sup> (Class C2 - EN 12004)	≥ 10 N/mm <sup>2</sup> (Class C2 - EN 12004)	≥ 10 N/mm <sup>2</sup> (Class C2 - EN 12004)	≥ 10 N/mm <sup>2</sup> (Class C2 - EN 12004)	≥ 10 N/mm <sup>2</sup> (Class C2 - EN 12004)	≥ 10 N/mm <sup>2</sup> (Class C2 - EN 12004)	≥ 10 N/mm <sup>2</sup> (Class C2 - EN 12004)
A1 - A1 <sub>fl</sub>	A1 - A1 <sub>fl</sub>	A1 - A1 <sub>fl</sub>	A1 - A1 <sub>fl</sub>	A1 - A1 <sub>fl</sub>	A1 - A1 <sub>fl</sub>	A1 - A1 <sub>fl</sub>	A1 - A1 <sub>fl</sub>	A1 - A1 <sub>fl</sub>	A1 - A1 <sub>fl</sub>	A1 - A1 <sub>fl</sub>
A	A	A	A	A	A	A	A	A	A	A
LA	LA	LA	LA	LA	LA	LA	LA	LA	LA	LA
HA	HA	HA	HA	HA	HA	HA	HA	HA	HA	HA
5	5	5	5	5	5	5	5	5	5	5
R10	R9	R11	R11	R10	R9	R11	R11	R10	R12	R11
A+B	A	A+B+C	A+B+C	A+B	A	A+B+C	A+B+C	A+B	A+B+C	A+B+C
≥ 36 Dry ≥ 36 Wet	●	≥ 36 Dry ≥ 36 Wet	≥ 36 Dry ≥ 36 Wet	≥ 36 Dry ≥ 36 Wet	●	≥ 36 Dry ≥ 36 Wet	≥ 36 Dry ≥ 36 Wet	≥ 36 Dry ≥ 36 Wet	≥ 36 Dry ≥ 36 Wet	≥ 36 Dry ≥ 36 Wet
Class P3	●●	Class P4	Class P4	Class P3	●●	Class P4	Class P4	Class P3	Class P4	Class P4
Class C2	●●●	Class C3	Class C3	Class C2	●●●	Class C3	Class C3	Class C2	Class C3	Class C3
> 0,40 Asciutto > 0,40 Bagnato	> 0,40 Asciutto > 0,40 Bagnato	> 0,40 Asciutto > 0,40 Bagnato	> 0,40 Asciutto > 0,40 Bagnato	> 0,40 Asciutto > 0,40 Bagnato	> 0,40 Asciutto > 0,40 Bagnato	> 0,40 Asciutto > 0,40 Bagnato	> 0,40 Asciutto > 0,40 Bagnato	> 0,40 Asciutto > 0,40 Bagnato	> 0,40 Asciutto > 0,40 Bagnato	> 0,40 Asciutto > 0,40 Bagnato
> 0,42 Wet	> 0,42 Wet	> 0,42 Wet	> 0,42 Wet	> 0,42 Wet	> 0,42 Wet	> 0,42 Wet	> 0,42 Wet	> 0,42 Wet	> 0,42 Wet	> 0,42 Wet

● PTV ≥ 36 Wet on demand - su richiesta ●● P3 on demand - su richiesta ●●● C2 on demand - su richiesta ■ R9 on demand - su richiesta ✖ DCOF > 0,42 Wet on demand - su richiesta









TECHNICAL FEATURE  
PORCELAIN TILES

		Requirements for nominal size N Requisiti per dimensione nominale N			MEK	NID	NORDE				
		7 cm ≤ N < 15 cm (mm)	N ≥ 15 cm (%) (mm)				Matte	Matte	Matte	Grip	Roccia
Regularity characteristics	Length and width Lunghezza e larghezza	± 0.9 (*) Non-rect. ± 0.4 (*) Rect.	± 0.6 (*) Non-rect. ± 0.3 (*) Rect.	± 2.0 (*) Non-rect. ± 1.0 (*) Rect.	Suitable for Conforme	Suitable for Conforme	Suitable for Conforme	Suitable for Conforme	Suitable for Conforme	Suitable for Conforme	Suitable for Conforme
	Thickness Spessore	± 0.5 (**)	± 5 (**)	± 0.5 (**)	Suitable for Conforme	Suitable for Conforme	Suitable for Conforme	Suitable for Conforme	Suitable for Conforme	Suitable for Conforme	Suitable for Conforme
	Straightness of sides Rettilineità degli spigoli	± 0.8 (***) Non-rect. ± 0.4 (***) Rect.	± 0.5 (***) Non-rect. ± 0.3 (***) Rect.	± 1.5 (***) Non-rect. ± 0.8 (***) Rect.	Suitable for Conforme	Suitable for Conforme	Suitable for Conforme	Suitable for Conforme	Suitable for Conforme	Suitable for Conforme	Suitable for Conforme
Regularity characteristics	Rectangularity (Measurement only on short edges when L/l ≥ 3) Ortogonalità (Misurazione da condurre solo sui lati corti quando L/l ≥ 3)	± 0.8 (***) Non-rect. ± 0.4 (***) Rect.	± 0.5 (***) Non-rect. ± 0.3 (***) Rect.	± 2.0 (***) Non-rect. ± 1.5 (***) Rect.	Suitable for Conforme	Suitable for Conforme	Suitable for Conforme	Suitable for Conforme	Suitable for Conforme	Suitable for Conforme	Suitable for Conforme
	Surface flatness Planarità	c.c. ± 0.8 Non-rect. c.c. ± 0.6 Rect.	c.c. ± 0.5 Non-rect. c.c. ± 0.4 Rect.	c.c. ± 2.0 Non-rect. c.c. ± 1.8 Rect.	Suitable for Conforme	Suitable for Conforme	Not applicable to 'strong' structures Non applicabile a strutture forti Not applicable to 'strong' structures Non applicabile a strutture forti				
		e.c. ± 0.8 Non-rect. e.c. ± 0.6 Rect.	e.c. ± 0.5 Non-rect. e.c. ± 0.4 Rect.	e.c. ± 2.0 Non-rect. e.c. ± 1.8 Rect.							
w. ± 0.8 Non-rect. w. ± 0.6 Rect.		w. ± 0.5 Non-rect. w. ± 0.4 Rect.	w. ± 2.0 Non-rect. w. ± 1.8 Rect.								
Structural characteristics	Water absorption (in % by mass) Massa d'acqua assorbita (come % della massa)	ISO 10545-3	E <sub>s</sub> ≤ 0.5% Individual max 0.6% E <sub>s</sub> ≤ 0.5% Valore max singolo 0,6%			≤ 0.1%	≤ 0.1%	≤ 0.1%	≤ 0.1%	≤ 0.1%	≤ 0.1%
		ASTM C373-18	Requirement ANSI A137.1 Water Absorption Max ≤ 0.5%			≤ 0.5%	≤ 0.5%	≤ 0.5%	≤ 0.5%	≤ 0.5%	≤ 0.5%
Bulk mechanical characteristics	Breaking strength Sforzo di rottura	ISO 10545-4	S ≥ 700N (for thickness < 7.5 mm – per spessore < 7,5 mm) S ≥ 1300N (for thickness ≥ 7.5 mm – per spessore ≥ 7,5 mm)			S ≥ 1500 N	S ≥ 1500 N	S ≥ 1500 N	S ≥ 1500 N	S ≥ 1500 N	S ≥ 10000 N
	Modulus of rupture Resistenza alla flessione		R ≥ 35 N/mm <sup>2</sup>			R ≥ 40 N/mm <sup>2</sup>	R ≥ 40 N/mm <sup>2</sup>	R ≥ 40 N/mm <sup>2</sup>	R ≥ 40 N/mm <sup>2</sup>	R ≥ 40 N/mm <sup>2</sup>	R ≥ 45 N/mm <sup>2</sup>
	Bending strength and breaking load Resistenza a flessione e al carico di rottura (4)(5)	EN 1339 Annex F	-			-	-	-	-	-	≥ T11 60x60    ≥ U4 60x120    ≥ U11 80x80    60x90
Surface mechanical characteristics	Impact resistance, as coefficient of restitution Resistenza all'impatto, espresso come coefficiente di restituzione	ISO 10545-5	Declared value Valore dichiarato			≥ 0.55	≥ 0.55	≥ 0.55	≥ 0.55	≥ 0.55	≥ 0.55
		EN 101	-			6	6	7	8	8	8
Surface mechanical characteristics	Resistance to deep abrasion of unglazed tiles (removed volume) Resistenza all'abrasione profonda delle piastrelle non smaltate (volume materiale asportato)	ISO 10545-6	≤ 175 mm <sup>3</sup>			≤ 150 mm <sup>3</sup>	≤ 150 mm <sup>3</sup>	≤ 150 mm <sup>3</sup>	≤ 150 mm <sup>3</sup>	≤ 150 mm <sup>3</sup>	≤ 150 mm <sup>3</sup>
			Declared value Valore dichiarato			≤ 7 MK <sup>-1</sup>	≤ 7 MK <sup>-1</sup>	≤ 7 MK <sup>-1</sup>	≤ 7 MK <sup>-1</sup>	≤ 7 MK <sup>-1</sup>	≤ 7 MK <sup>-1</sup>
Thermal and hygrometric characteristics	Coefficient of thermal linear expansion Coefficiente di dilatazione termica lineare	ISO 10545-8	Declared value Valore dichiarato			≤ 7 MK <sup>-1</sup>	≤ 7 MK <sup>-1</sup>	≤ 7 MK <sup>-1</sup>	≤ 7 MK <sup>-1</sup>	≤ 7 MK <sup>-1</sup>	≤ 7 MK <sup>-1</sup>
		ISO 10545-9	Pass according to EN ISO 10545-1 Test superato in accordo con ISO 10545-1			Resistant Resiste	Resistant Resiste	Resistant Resiste	Resistant Resiste	Resistant Resiste	Resistant Resiste
		ISO 10545-10	Declared value Valore dichiarato			≤ 0.01% (0,1mm/m)	≤ 0.01% (0,1mm/m)	≤ 0.01% (0,1mm/m)	≤ 0.01% (0,1mm/m)	≤ 0.01% (0,1mm/m)	≤ 0.01% (0,1mm/m)
Thermal and hygrometric characteristics	Moisture expansion (in mm/m) Dilatazione all'umidità (in mm/m)	ISO 10545-12	Pass according to EN ISO 10545-1 Test superato in accordo con ISO 10545-1			Resistant Resiste	Resistant Resiste	Resistant Resiste	Resistant Resiste	Resistant Resiste	Resistant Resiste
		ISO 10545-11	Declared value Valore dichiarato			≥ 10 N/ mm <sup>2</sup> (Class C2 - EN 12004)	≥ 10 N/ mm <sup>2</sup> (Class C2 - EN 12004)	≥ 10 N/ mm <sup>2</sup> (Class C2 - EN 12004)	≥ 10 N/ mm <sup>2</sup> (Class C2 - EN 12004)	≥ 10 N/ mm <sup>2</sup> (Class C2 - EN 12004)	≥ 10 N/ mm <sup>2</sup> (Class C2 - EN 12004)
Physical properties	Bond strength/adhesion for improved cementitious adhesives Adezione a trazione con adesivi cementizi migliorati	EN 1348	Declared value Valore dichiarato			≥ 10 N/ mm <sup>2</sup> (Class C2 - EN 12004)	≥ 10 N/ mm <sup>2</sup> (Class C2 - EN 12004)	≥ 10 N/ mm <sup>2</sup> (Class C2 - EN 12004)	≥ 10 N/ mm <sup>2</sup> (Class C2 - EN 12004)	≥ 10 N/ mm <sup>2</sup> (Class C2 - EN 12004)	≥ 10 N/ mm <sup>2</sup> (Class C2 - EN 12004)
			Class A1 or A1 <sub>g</sub> Classe A1 oppure A1 <sub>g</sub>			A1 - A1 <sub>g</sub>	A1 - A1 <sub>g</sub>	A1 - A1 <sub>g</sub>	A1 - A1 <sub>g</sub>	A1 - A1 <sub>g</sub>	A1 - A1 <sub>g</sub>
Chemical characteristics	Resistance to household chemicals and swimming pool salts Resistenza ai prodotti chimici di uso domestico ed agli additivi per piscina		Minimum Class B Classe minima B			A	A	A	A	A	A
		ISO 10545-13	Declared Class Classe dichiarata			LA	LA	LA	LA	LA	LA
			Declared Class Classe dichiarata			HA	HA	HA	HA	HA	HA
	Resistance to staining, for unglazed tiles Resistenza alle macchie per piastrelle non smaltate	ISO 10545-14	Declared Class Classe dichiarata			5	5	5	5	5	5
Safety characteristics (1)(2)	Shod Ramp Test Metodo della rampa "calzato"	DIN 51130	Declared value Valore dichiarato			R10	R10	R10	R11	R12	R11
		DIN 51097	Declared value Valore dichiarato			A	A	A+B	A+B+C	A+B+C	A+B+C
	Barefoot Ramp Test Metodo della rampa a piedi nudi	BS 7976	PTV ≥ 36 classifies the surface as "low slip risk"			(●)	≥ 36 Dry ≥ 36 Wet	≥ 36 Dry ≥ 36 Wet	≥ 36 Dry ≥ 36 Wet	≥ 36 Dry ≥ 36 Wet	≥ 36 Dry ≥ 36 Wet
		AS 4586	Declared Classification of the new pedestrian surface materials according to the Pendulum Test			(●●)	Class P3	Class P3	Class P4	Class P4	Class P4
		UNE-ENV 12633 UNE 41901:2017 EX	Declared value Valore dichiarato			(●●●)	(●●●)	Class C2	Class C3	Class C3	Class C3
	Coefficient of friction (COF) Coefficiente di attrito	B.C.R.A. Rep. CEC/81	D. M. 236/89 del 14/06/89 μ > 0.40 per elemento scivolante cuoio su pavimentazione asciutta μ > 0.40 per elemento scivolante gomma dura su pavimentazione bagnata			> 0.40 Asciutto > 0.40 Bagnato	> 0.40 Asciutto > 0.40 Bagnato	> 0.40 Asciutto > 0.40 Bagnato	> 0.40 Asciutto > 0.40 Bagnato	> 0.40 Asciutto > 0.40 Bagnato	> 0.40 Asciutto > 0.40 Bagnato
			ANSI A137.1	ANSI A.137.1-2017 Requires a minimum value of 0.42 for level interior space expected to be walked upon when wet. (3)			> 0.42 Wet	> 0.42 Wet	> 0.42 Wet	> 0.42 Wet	> 0.42 Wet

Technical feature - Caratteristiche tecniche - Caractéristiques techniques - Technische Daten - Características técnicas - Технические характеристики

PRISM					RAW				TRUST			VENTI BOOST
Matte	Matte ± 6mm	Silk	Grip	Outdoor ± 20mm	Matte	Matte ± 6mm	Grip	Outdoor ± 20mm	Matte	Grip	Outdoor ± 20mm *	Matte (Cold e Warm)
Suitable for Conforme	Suitable for Conforme	Suitable for Conforme	Suitable for Conforme	Suitable for Conforme	Suitable for Conforme	Suitable for Conforme	Suitable for Conforme	Suitable for Conforme	Suitable for Conforme	Suitable for Conforme	Suitable for Conforme	Suitable for Conforme
Suitable for Conforme	Suitable for Conforme	Suitable for Conforme	Suitable for Conforme	Suitable for Conforme	Suitable for Conforme	Suitable for Conforme	Suitable for Conforme	Suitable for Conforme	Suitable for Conforme	Suitable for Conforme	Suitable for Conforme	Suitable for Conforme
Suitable for Conforme	Suitable for Conforme	Suitable for Conforme	Suitable for Conforme	Suitable for Conforme	Suitable for Conforme	Suitable for Conforme	Suitable for Conforme	Suitable for Conforme	Suitable for Conforme	Suitable for Conforme	Suitable for Conforme	Suitable for Conforme
Suitable for Conforme	Suitable for Conforme	Suitable for Conforme	Suitable for Conforme	Suitable for Conforme	Suitable for Conforme	Suitable for Conforme	Suitable for Conforme	Suitable for Conforme	Suitable for Conforme	Suitable for Conforme	Suitable for Conforme	Suitable for Conforme
Suitable for Conforme	Suitable for Conforme	Suitable for Conforme	Suitable for Conforme	Suitable for Conforme	Suitable for Conforme	Suitable for Conforme	Suitable for Conforme	Suitable for Conforme	Suitable for Conforme	Suitable for Conforme	Suitable for Conforme	Suitable for Conforme
Suitable for Conforme	Suitable for Conforme	Suitable for Conforme	Suitable for Conforme	Suitable for Conforme	Suitable for Conforme	Suitable for Conforme	Suitable for Conforme	Suitable for Conforme	Suitable for Conforme	Suitable for Conforme	Suitable for Conforme	Suitable for Conforme
Suitable for Conforme	Suitable for Conforme	Suitable for Conforme	Suitable for Conforme	Suitable for Conforme	Suitable for Conforme	Suitable for Conforme	Suitable for Conforme	Suitable for Conforme	Suitable for Conforme	Suitable for Conforme	Suitable for Conforme	Suitable for Conforme
Suitable for Conforme	Suitable for Conforme	Suitable for Conforme	Suitable for Conforme	Suitable for Conforme	Suitable for Conforme	Suitable for Conforme	Suitable for Conforme	Suitable for Conforme	Suitable for Conforme	Suitable for Conforme	Suitable for Conforme	Suitable for Conforme
Suitable for Conforme	Suitable for Conforme	Suitable for Conforme	Suitable for Conforme	Suitable for Conforme	Suitable for Conforme	Suitable for Conforme	Suitable for Conforme	Suitable for Conforme	Suitable for Conforme	Suitable for Conforme	Suitable for Conforme	Suitable for Conforme
Suitable for Conforme	Suitable for Conforme	Suitable for Conforme	Suitable for Conforme	Suitable for Conforme	Suitable for Conforme	Suitable for Conforme	Suitable for Conforme	Suitable for Conforme	Suitable for Conforme	Suitable for Conforme	Suitable for Conforme	Suitable for Conforme
Suitable for Conforme	Suitable for Conforme	Suitable for Conforme	Suitable for Conforme	Suitable for Conforme	Suitable for Conforme	Suitable for Conforme	Suitable for Conforme	Suitable for Conforme	Suitable for Conforme	Suitable for Conforme	Suitable for Conforme	Suitable for Conforme
Suitable for Conforme	Suitable for Conforme	Suitable for Conforme	Suitable for Conforme	Suitable for Conforme	Suitable for Conforme	Suitable for Conforme	Suitable for Conforme	Suitable for Conforme	Suitable for Conforme	Suitable for Conforme	Suitable for Conforme	Suitable for Conforme
Suitable for Conforme	Suitable for Conforme	Suitable for Conforme	Suitable for Conforme	Suitable for Conforme	Suitable for Conforme	Suitable for Conforme	Suitable for Conforme	Suitable for Conforme	Suitable for Conforme	Suitable for Conforme	Suitable for Conforme	Suitable for Conforme
Suitable for Conforme	Suitable for Conforme	Suitable for Conforme	Suitable for Conforme	Suitable for Conforme	Suitable for Conforme	Suitable for Conforme	Suitable for Conforme	Suitable for Conforme	Suitable for Conforme	Suitable for Conforme	Suitable for Conforme	Suitable for Conforme
Suitable for Conforme	Suitable for Conforme	Suitable for Conforme	Suitable for Conforme	Suitable for Conforme	Suitable for Conforme	Suitable for Conforme	Suitable for Conforme	Suitable for Conforme	Suitable for Conforme	Suitable for Conforme	Suitable for Conforme	Suitable for Conforme
Suitable for Conforme	Suitable for Conforme	Suitable for Conforme	Suitable for Conforme	Suitable for Conforme	Suitable for Conforme	Suitable for Conforme	Suitable for Conforme	Suitable for Conforme	Suitable for Conforme	Suitable for Conforme	Suitable for Conforme	Suitable for Conforme
Suitable for Conforme	Suitable for Conforme	Suitable for Conforme	Suitable for Conforme	Suitable for Conforme	Suitable for Conforme	Suitable for Conforme	Suitable for Conforme	Suitable for Conforme	Suitable for Conforme	Suitable for Conforme	Suitable for Conforme	Suitable for Conforme
Suitable for Conforme	Suitable for Conforme	Suitable for Conforme	Suitable for Conforme	Suitable for Conforme	Suitable for Conforme	Suitable for Conforme	Suitable for Conforme	Suitable for Conforme	Suitable for Conforme	Suitable for Conforme	Suitable for Conforme	Suitable for Conforme
Suitable for Conforme	Suitable for Conforme	Suitable for Conforme	Suitable for Conforme	Suitable for Conforme	Suitable for Conforme	Suitable for Conforme	Suitable for Conforme	Suitable for Conforme	Suitable for Conforme	Suitable for Conforme	Suitable for Conforme	Suitable for Conforme
Suitable for Conforme	Suitable for Conforme	Suitable for Conforme	Suitable for Conforme	Suitable for Conforme	Suitable for Conforme	Suitable for Conforme	Suitable for Conforme	Suitable for Conforme	Suitable for Conforme	Suitable for Conforme	Suitable for Conforme	Suitable for Conforme
Suitable for Conforme	Suitable for Conforme	Suitable for Conforme	Suitable for Conforme	Suitable for Conforme	Suitable for Conforme	Suitable for Conforme	Suitable for Conforme	Suitable for Conforme	Suitable for Conforme	Suitable for Conforme	Suitable for Conforme	Suitable for Conforme
Suitable for Conforme	Suitable for Conforme	Suitable for Conforme	Suitable for Conforme	Suitable for Conforme	Suitable for Conforme	Suitable for Conforme	Suitable for Conforme	Suitable for Conforme	Suitable for Conforme	Suitable for Conforme	Suitable for Conforme	Suitable for Conforme
Suitable for Conforme	Suitable for Conforme	Suitable for Conforme	Suitable for Conforme	Suitable for Conforme	Suitable for Conforme	Suitable for Conforme	Suitable for Conforme	Suitable for Conforme	Suitable for Conforme	Suitable for Conforme	Suitable for Conforme	Suitable for Conforme
Suitable for Conforme	Suitable for Conforme	Suitable for Conforme	Suitable for Conforme	Suitable for Conforme	Suitable for Conforme	Suitable for Conforme	Suitable for Conforme	Suitable for Conforme	Suitable for Conforme	Suitable for Conforme	Suitable for Conforme	Suitable for Conforme
Suitable for Conforme	Suitable for Conforme	Suitable for Conforme	Suitable for Conforme	Suitable for Conforme	Suitable for Conforme	Suitable for Conforme	Suitable for Conforme	Suitable for Conforme	Suitable for Conforme	Suitable for Conforme	Suitable for Conforme	Suitable for Conforme
Suitable for Conforme	Suitable for Conforme	Suitable for Conforme	Suitable for Conforme	Suitable for Conforme	Suitable for Conforme	Suitable for Conforme	Suitable for Conforme	Suitable for Conforme	Suitable for Conforme	Suitable for Conforme	Suitable for Conforme	Suitable for Conforme
Suitable for Conforme	Suitable for Conforme	Suitable for Conforme	Suitable for Conforme	Suitable for Conforme	Suitable for Conforme	Suitable for Conforme	Suitable for Conforme	Suitable for Conforme	Suitable for Conforme	Suitable for Conforme	Suitable for Conforme	Suitable for Conforme
Suitable for Conforme	Suitable for Conforme	Suitable for Conforme	Suitable for Conforme	Suitable for Conforme	Suitable for Conforme	Suitable for Conforme	Suitable for Conforme	Suitable for Conforme	Suitable for Conforme	Suitable for Conforme	Suitable for Conforme	Suitable for Conforme
Suitable for Conforme	Suitable for Conforme	Suitable for Conforme	Suitable for Conforme	Suitable for Conforme	Suitable for Conforme	Suitable for Conforme	Suitable for Conforme	Suitable for Conforme	Suitable for Conforme	Suitable for Conforme	Suitable for Conforme	Suitable for Conforme
Suitable for Conforme	Suitable for Conforme	Suitable for Conforme	Suitable for Conforme	Suitable for Conforme	Suitable for Conforme	Suitable for Conforme	Suitable for Conforme	Suitable for Conforme	Suitable for Conforme	Suitable for Conforme	Suitable for Conforme	Suitable for Conforme
Suitable for Conforme	Suitable for Conforme	Suitable for Conforme	Suitable for Conforme	Suitable for Conforme	Suitable for Conforme	Suitable for Conforme	Suitable for Conforme	Suitable for Conforme	Suitable for Conforme	Suitable for Conforme	Suitable for Conforme	Suitable for Conforme
Suitable for Conforme	Suitable for Conforme	Suitable for Conforme	Suitable for Conforme	Suitable for Conforme	Suitable for Conforme	Suitable for Conforme	Suitable for Conforme	Suitable for Conforme	Suitable for Conforme	Suitable for Conforme	Suitable for Conforme	Suitable for Conforme
Suitable for Conforme	Suitable for Conforme	Suitable for Conforme	Suitable for Conforme	Suitable for Conforme	Suitable for Conforme	Suitable for Conforme	Suitable for Conforme	Suitable for Conforme	Suitable for Conforme	Suitable for Conforme	Suitable for Conforme	Suitable for Conforme
Suitable for Conforme	Suitable for Conforme	Suitable for Conforme	Suitable for Conforme	Suitable for Conforme	Suitable for Conforme	Suitable for Conforme	Suitable for Conforme	Suitable for Conforme	Suitable for Conforme	Suitable for Conforme	Suitable for Conforme	Suitable for Conforme
Suitable for Conforme	Suitable for Conforme	Suitable for Conforme	Suitable for Conforme	Suitable for Conforme	Suitable for Conforme	Suitable for Conforme	Suitable for Conforme	Suitable for Conforme	Suitable for Conforme	Suitable for Conforme	Suitable for Conforme	Suitable for Conforme
Suitable for Conforme	Suitable for Conforme	Suitable for Conforme	Suitable for Conforme	Suitable for Conforme	Suitable for Conforme	Suitable for Conforme	Suitable for Conforme	Suitable for Conforme	Suitable for Conforme	Suitable for Conforme	Suitable for Conforme	Suitable for Conforme
Suitable for Conforme	Suitable for Conforme	Suitable for Conforme	Suitable for Conforme	Suitable for Conforme	Suitable for Conforme	Suitable for Conforme	Suitable for Conforme	Suitable for Conforme	Suitable for Conforme	Suitable for Conforme	Suitable for Conforme	Suitable for Conforme
Suitable for Conforme	Suitable for Conforme	Suitable for Conforme	Suitable for Conforme	Suitable for Conforme	Suitable for Conforme	Suitable for Conforme	Suitable for Conforme	Suitable for Conforme	Suitable for Conforme	Suitable for Conforme	Suitable for Conforme	Suitable for Conforme
Suitable for Conforme	Suitable for Conforme	Suitable for Conforme	Suitable for Conforme	Suitable for Conforme	Suitable for Conforme	Suitable for Conforme	Suitable for Conforme	Suitable for Conforme	Suitable for Conforme	Suitable for Conforme	Suitable for Conforme	Suitable for Conforme
Suitable for Conforme	Suitable for Conforme	Suitable for Con										

**TECHNICAL FEATURE**  
PORCELAIN TILES

**Atlas Plan**



COLOURED BODY PORCELAIN TILES - NON RECTIFIED

		Requirements for nominal size N Requisiti per dimensione nominale N		162x324 cm - 63 3/4"x127 1/2" Non Rectified			
		N ≥ 15 cm		Silk	Matte Hammered Flamed	Polished Satin	
		(%)	(mm)				
Regularity characteristics	<b>Thickness</b> Spessore	ISO 10545-2	± 5 (**)	± 5,0% ± 0,5 mm			
	<b>Surface flatness</b> Planarità		c.c. ± 0,5	± 0,5% ± 2,0 mm			
			e.c. ± 0,5				
			w. ± 0,5				
		<b>EN 144TI annex e; (Group Bla)</b> EN 74477 appendice G (Gruppo Bla)	<b>ISO 13006 annex e; (Group Bla)</b> 150 73006 appendice G (Gruppo Bla)				
Structural characteristics	<b>Water absorption</b> Massa d'acqua assorbita	ISO 10545-3	<b>E<sub>w</sub> ≤ 0,5% Individual max 0,6%</b> E <sub>w</sub> ≤ 0,5% Valore max singolo 0,6%		≤ 0,1 %		
		ASTM C373	<b>Requirement ANSI A137.1 Water Absorption Max ≤ 0,5%</b>		≤ 0,5 %		
Bulk mechanical characteristics	<b>Breaking strength</b> Sforzo di rottura	ISO 10545-4	S ≥ 700 N <b>for thickness &lt; 7,5mm</b> per spessore < 7,5mm	S ≥ 1300 N <b>for thickness ≥ 7,5mm</b> per spessore ≥ 7,5mm	6 mm -> S ≥ 1000N		
	<b>Modulus of rupture</b> Resistenza alla flessione		R ≥ 35 N/mm <sup>2</sup>	R ≥ 45 N/mm <sup>2</sup>			
Surface mechanical characteristics	<b>Mohs hardness</b> Durezza Mohs	EN 101	-		6	5	
	<b>Resistance to deep abrasion of unglazed tiles (removed volume)</b> Resistenza all'abrasione profonda delle piastrelle non smaltate (volume materiale asportato)	ISO 10545-6	≤ 175 mm <sup>3</sup>		≤ 160 mm <sup>3</sup>		
Thermal and hygrometric characteristics	<b>Coefficient of thermal linear expansion</b> Coefficiente di dilatazione termica lineare	ISO 10545-8	<b>Declared value</b> Valore dichiarato	<b>Test method available</b> Metodo di prova disponibile	≤ 9 M°C <sup>-1</sup>		
	<b>Thermal shock resistance</b> Resistenza agli sbalzi termici	ISO 10545-9	<b>Pass according to EN ISO 10545-1</b> Test superato in accordo con ISO 10545-1	<b>Test method available</b> Metodo di prova disponibile	<b>Resistant</b> Resiste		
	<b>Moisture expansion (in mm/m)</b> Dilatazione all'umidità (in mm/m)	ISO 10545-10	<b>Declared value</b> Valore dichiarato	<b>Test method available</b> Metodo di prova disponibile	≤ 0,01% (0,1mm/m)		
	<b>Frost resistance</b> Resistenza al gelo	ISO 10545-12	<b>Pass according to EN ISO 10545-1</b> Test superato in accordo con ISO 10545-1	<b>Required</b> Metodo di prova richiesto	<b>Resistant</b> Resiste		
Physical properties	<b>Bond strength/adhesion for improved cementitious adhesives</b> Adesione a trazione con adesivi cementizi migliorati	EN 1348	<b>Declared value</b> Valore dichiarato	-	≥ 1,0 N/mm <sup>2</sup> (Class C2 - EN 12004)		
	<b>Reaction to fire</b> Reazione al fuoco	-	<b>Class A1</b> Classe A1	-	<b>A1 (without fiberglass)</b> A2 (with fiberglass)		
Chemical characteristics	<b>Resistance to household chemicals and swimming pool salts</b> Resistenza ai prodotti chimici di uso domestico ed agli additivi per piscina	ISO 10545-13	<b>Minimum Class B (U for unglazed tiles)</b> Classe minima B (U per piastrelle non smaltate)		A		
	<b>Resistance to low concentrations of acids and alkalis</b> Resistenza a basse concentrazioni di acidi e alcali		<b>Declared Class</b> Classe dichiarata	<b>Manufacturer is to state classification</b> Secondo la classificazione indicata dal fabbricante	LA	LA	LA
	<b>Resistance to high concentrations of acids and alkalis</b> Resistenza ad alte concentrazioni di acidi e alcali		<b>Declared Class</b> Classe dichiarata	<b>Test method available</b> Metodo di prova disponibile	HA	HA	-
	<b>Resistance to staining</b> Resistenza alle macchie	ISO 10545-14	<b>Declared Class</b> Classe dichiarata	<b>Test method available</b> Metodo di prova disponibile	5		
	<b>Release of dangerous substances: Cadmium (in mg/dm<sup>2</sup>) and Lead (in mg/dm<sup>2</sup>)</b> Rilascio di sostanze pericolose: Cadmio (in mg/dm <sup>2</sup> ) e Piombo (in mg/dm <sup>2</sup> )	ISO 10545-15	<b>Declared value</b> Valore dichiarato	<b>Test method available</b> Metodo di prova disponibile	≤ 0,01 mg/dm <sup>2</sup> Cd ≤ 0,1 mg/dm <sup>2</sup> Pb		
	<b>Resistance to scratching</b> Resistenza alla graffiatura	UNI EN 15186:2012 met.B			<b>CEN/TS 16209 Class A</b> CEN/TS 16209 Classe A		
	<b>Tendency to retain dirt</b> Tendenza a ritenere lo sporco	UNI 9300:2015			<b>No visible change (5)</b> Nessun cambiamento visibile (5)		
	<b>Surface resistance to cold liquids</b> Resistenza delle superfici ai liquidi freddi	UNI EN 12720:2013			<b>CEN/TS 16209 Class A</b> CEN/TS 16209 Classe A		
	<b>Surface resistance to wet heat</b> Resistenza delle superfici al calore umido	UNI EN 12721:2013			<b>CEN/TS 16209 Class A</b> CEN/TS 16209 Classe A		
	<b>Surface resistance to dry heat</b> Resistenza delle superfici al calore secco	UNI EN 12722:2013			<b>CEN/TS 16209 Class A</b> CEN/TS 16209 Classe A		
	<b>Assessment of resistance to impact</b> Resistenza all'urto	ISO 4211-4:1988			<b>Maximum drop height according to thickness.</b> Altezza massima di caduta variabile in funzione dello spessore.		

Technical feature - Caratteristiche tecniche - Caractéristiques techniques - Technische Daten - Características técnicas - Технические характеристики

Coloured body porcelain tiles - Non rectified - Gres porcellanato colorato in massa - non rettificato - Grès cérame coloré dans la masse - Non rectifié - Durchgefärbtes Feinsteinzeug - Nicht rektifiziert - Gres porcelánico coloreado en masa - No rectificada - Керамический гранит окрашенный в массе - Неректифицированные

**UPEC CERTIFICATION**

Serie / Series  
Série / Serie  
Serie / Серия

**AIX** Porcelain tiles

**AXI** Porcelain tiles

**BLAZE** Porcelain tiles

**BOOST** Porcelain tiles

**BOOST PRO** Porcelain tiles

**BRAVE** Porcelain tiles

**DOLMEN PRO** Porcelain tiles

**DWELL** Porcelain tiles

**ETIC** Porcelain tiles

**ETIC PRO** Porcelain tiles

**EXENCE** Porcelain tiles (20x120 cm)

**HEARTWOOD** Porcelain tiles (20x120 cm)

**MARVEL DREAM** Porcelain tiles

**LIMS** Porcelain tiles

**MARK** Porcelain tiles

**MARVEL** Porcelain tiles

**MARVEL EDGE** Porcelain tiles

**MARVEL GEMS** Porcelain tiles

**MARVEL SHINE** Porcelain tiles

**MARVEL PRO** Porcelain tiles

**MARVEL STONE** Porcelain tiles

**NID** Porcelain tiles (15x90 cm)

**PRISM** Porcelain tiles

**RAW** Porcelain tiles

**TRUST** Porcelain tiles

**VENTI BOOST** Porcelain tiles

**Classificazione UPEC/UPEC F+ - in via di certificazione**

Classification UPEC/UPEC F+ - en cours de certification

Serie / Series  
Série / Serie  
Serie / Серия

**BOOST NATURAL** Porcelain tiles

**BOOST STONE** Porcelain tiles

**NORDE** Porcelain tiles

Si consiglia la consultazione della pagina  
https://www.atlasconcorde.com/it/company/responsabilite/certifications  
Per ulteriori informazioni scrivere a france@atlasconcorde.it

On vous conseille de vous connecter à:  
https://www.atlasconcorde.com/fr/company/responsabilite/certifications  
Pour tous renseignements complémentaires merci d'écrire à france@atlasconcorde.it

UPEC certification - Classificazione UPEC - Classification UPEC - UPEC Klassifizierung - Clasificación UPEC - Классификация UPEC

INDEX



PRODUCT  
FINDER



SURFACE  
RANGE



COMPANY



COLLECTIONS



LARGE SIZES



TECHNICAL  
SPECIFICATIONS



ANTI-SLIP CLASSIFICATION

PORCELAIN TILES



SAFETY CHARACTERISTICS CARATTERISTICHE DI SICUREZZA *										
Serie / Series Série / Serie Serie / Серия	Superficie / Surface Surface / Oberfläche Superficie / Поверхность	Shod Ramp Test Metodo della rampa "calzato" (DIN 51130) *				Barefoot Ramp Test Metodo della rampa a piedi nudi (DIN 51097) *			Pendulum Friction Test Metodo del pendolo (BS 7976) *	
		R9	R10	R11	R12	A	A+B	A+B+C	≥ 36 Dry ≥ 36 Wet	
Aix	Matte Matt		✗				✗			✗
	Grip Grip			✗				✗		✗
	Textured Strutturato			✗			✗			✗
Axi	Matte Matt		✗				✗			✗
	Textured Strutturato			✗			✗			✗
Blaze	Matte Matt		✗				✗			✗
	Matte Matt 6 mm	✗				✗				(●)
	Grip Grip			✗				✗		✗
Boost	Matte Matt		✗				✗			✗
	Matte Matt 6 mm	✗				✗				(●)
	Grip Grip			✗				✗		✗
Boost Mix	Matte Matt		✗				✗			✗
	Matte Matt 6 mm	✗				✗				(●)
	Grip Grip			✗				✗		✗
Boost Natural	Matte Matt		✗				✗			✗
	Matte Matt 6 mm	✗				✗				(●)
	Grip Grip			✗				✗		✗
Boost Pro	Matte Matt		✗				✗			✗
	Matte Matt 6 mm	✗				✗				(●)
	Grip Grip			✗				✗		✗
Boost Stone	Matte Matt		✗				✗			✗
	Matte Matt 6 mm	✗				✗				(●)
	Grip Grip			✗				✗		✗
Brave	Matte Matt		✗				✗			✗
	Grip Grip				✗			✗		✗
	Matte Matt		✗				✗			✗
Dolmen Pro	Grip Grip			✗				✗		✗
	Textured Strutturato			✗				✗		✗
Dwell	Matte Matt	✗					✗			✗
Etic	Matte Matt	✗					✗			✗
Etic PRO	Matte Matt	✗					✗			✗
	Grip Grip			✗				✗		✗
Exence	Matte Matt		✗				✗			✗
	Grip Grip			✗				✗		✗
Heartwood	Matte Matt 9.5 mm	✗				✗				(●)
	Matte Matt 9 mm		✗				✗			✗
Klif	Matte Matt		✗				✗			✗
	Grip Grip			✗				✗		✗
Kone	Matte Matt		✗				✗			✗
	Grip Grip			✗				✗		✗
Lims	Matte Matt		✗				✗			✗
	Matte Matt 6 mm	✗				✗				(●)
	Grip Grip			✗				✗		✗
Mark	Matte Matt		✗				✗			✗
	Matte Matt 9 mm		✗				✗			✗
Marvel Dream	Matte Matt 6 mm	✗				✗				(●)
	Matte Matt	✗				✗				(●)
Marvel Edge	Matte Matt	✗				✗				✗
Marvel Gems	Matte Matt		✗			✗				✗
Marvel Stone	Matte Matt	✗				✗				(●)
	Matte Matt 6 mm	✗				✗				(●)
	Textured Strutturato			✗				✗		✗
Marvel	Matte Matt	✗				✗				✗
	Matte Matt 6 mm	✗				✗				✗
	Matte Matt	✗				✗				✗
Marvel Pro	Matte Matt 6 mm	✗				✗				(●)
	Textured Strutturato			✗				✗		✗
Marvel Shine	Matte Matt 60x60	✗		✗			✗			✗
	Matte Matt		✗				✗			(●)
Mek	Matte Matt		✗			✗				✗
NID	Matte Matt		✗			✗				✗
	Matte Matt		✗			✗				✗
Norde	Grip Grip			✗				✗		✗
	Roccia Roccia				✗			✗		✗
Prism	Matte Matt		✗				✗			✗
	Matte Matt 6 mm	✗				✗				(●)
	Grip Grip			✗				✗		✗
Raw	Matte Matt		✗				✗			✗
	Matte Matt 6 mm	✗				✗				(●)
	Grip Grip			✗				✗		✗
Trust	Matte Matt		✗				✗			✗
	Grip Grip			✗				✗		✗
Venti Boost	Matte Matt		✗			✗				✗

Outdoor ± 20mm

\* Determination of slip resistance of pedestrian surfaces; it does not cover sports surfaces and road surfaces for vehicles (skid resistance). - Determinazione della resistenza allo scivolamento delle superfici pedonabili; non si applica alle pavimentazioni sportive ed alle pavimentazioni stradali veicolari. - Détermination de la résistance au glissement des surfaces piétonnes; elle ne s'applique pas aux sols sportifs, ni aux revêtements routiers. - Bestimmung der Rutschfestigkeit von begehbaren Oberflächen; gilt nicht für Sportböden und Straßenböden. - Determinación de la resistencia al deslizamiento de las superficies peatonales; no se aplica a las pavimentaciones deportivas y calzadas. - Установление сопротивления скольжению напольных покрытий; не применяется к спортивным напольным покрытиям и дорожным покрытиям, предназначенным для проезда транспорта.  
Anti-slip classification - Classificazione non-slip - Classification NON-SLIP - NON-SLIP Klassifizierung - Clasificación NON-SLIP - сопротивление скольжению

SAFETY CHARACTERISTICS CARATTERISTICHE DI SICUREZZA *										
Pendulum Friction Test Metodo del pendolo (AS 4586)				Pendulum Friction Test Metodo del pendolo (UNE-EN 12633)			Coefficient of friction COF Coefficiente di attrito (B.C.R.A)	Dynamic coefficient of friction (DCOF) Coefficiente di attrito dinamico DCOF (ANSI A137.1)	Superficie / Surface Surface / Oberfläche Superficie / Поверхность	Serie / Series Série / Serie Serie / Серия
Class P1	Class P2	Class P3	Class P4	Class C1	Class C2	Class C3	>0,40 Asciutto >0,40 Bagnato	>0,42 Wet		
		✗			✗		✗	✗	Matte Matt	Aix
			✗			✗	✗	✗	Grip Grip	
			✗			✗	✗	✗	Textured Strutturato	
		✗		✗			✗	✗	Matte Matt	Axi
			✗				✗	✗	Textured Strutturato	
		✗			✗		✗	✗	Matte Matt	Blaze
	(●●)			✗	(●●●)		✗	✗	Matte Matt 6 mm	
			✗			✗	✗	✗	Grip Grip	
	(●●)	✗			✗		✗	✗	Matte Matt	Boost
			✗			✗	✗	✗	Matte Matt 6 mm	
			✗			✗	✗	✗	Grip Grip	
	(●●)	✗			(●●●)		✗	✗	Matte Matt	Boost Mix
			✗				✗	✗	Matte Matt 6 mm	
			✗			✗	✗	✗	Grip Grip	
	(●●)			✗	(●●●)		✗	✗	Matte Matt	Boost Natural
			✗				✗	✗	Matte Matt 6 mm	
			✗			✗	✗	✗	Grip Grip	
	(●●)	✗			(●●●)		✗	✗	Matte Matt	Boost Pro
			✗				✗	✗	Matte Matt 6 mm	
			✗			✗	✗	✗	Grip Grip	
	(●●)	✗			(●●●)		✗	✗	Matte Matt	Boost Stone
			✗				✗	✗	Matte Matt 6 mm	
			✗			✗	✗	✗	Grip Grip	
	(●●)			✗		✗	✗	✗	Matte Matt	Brave
			✗			✗	✗	✗	Grip Grip	
		✗			✗		✗	✗	Matte Matt	Dolmen Pro
			✗				✗	✗	Grip Grip	
	(●●)			✗			✗	✗	Textured Strutturato	Dwell
	(●●)	(●●)			✗		✗	✗	Matte Matt	Etic
		(●●)			✗		✗	✗	Matte Matt	Etic PRO
			✗			✗	✗	✗	Grip Grip	
			✗				✗	✗	Matte Matt	Exence
			✗				✗	✗	Grip Grip	
	(●●)			✗	(●●●)		✗	✗	Matte Matt 9.5 mm	Heartwood
		✗				✗	✗	✗	Matte Matt 9 mm	
		✗				✗	✗	✗	Matte Matt	Klif
	(●●)			✗			✗	✗	Grip Grip	
		✗			✗		✗	✗	Matte Matt	Kone
		✗				✗	✗	✗	Grip Grip	
	(●●)			✗			✗	✗	Matte Matt	Lims
		✗			(●●●)		✗	✗	Matte Matt 6 mm	
			✗				✗	✗	Grip Grip	
	(●●)			✗	✗		✗	✗	Matte Matt	Mark
		✗				✗	✗	✗	Matte Matt 9 mm	
	(●●)			✗	(●●●)		✗	✗	Matte Matt 6 mm	Marvel Dream
		(●●)			(●●●)		✗	✗	Matte Matt 9.5 mm	
		(●●)			✗		✗	✗	Matte Matt	Marvel Edge
		(●●)			✗		✗	✗	Matte Matt	Marvel Gems
		(●●)			✗		✗	✗	Matte Matt	Marvel Stone
		(●●)			(●●●)		✗	✗	Matte Matt 6 mm	
			✗				✗	✗	Textured Strutturato	
	(●●)			✗	✗		✗	✗	Matte Matt	Marvel
		(●●)			(●●●)		✗	✗	Matte Matt 6 mm	
		(●●)			✗		✗	✗	Matte Matt	
		(●●)			(●●●)		✗	✗	Matte Matt 6 mm	Marvel Pro
			✗				✗	✗	Textured Strutturato	
	(●●)			✗	(●●●)		✗	✗	Matte Matt 60x60	Marvel Shine
		(●●)			✗		✗	✗	Matte Matt	
		(●●)			✗		✗	✗	Matte Matt	Mek
			✗			✗	✗	✗	Matte Matt	NID
			✗			✗	✗	✗	Matte Matt	
			✗				✗	✗	Grip Grip	Norde
			✗			✗	✗	✗	Roccia Roccia	
	(●●)			✗			✗	✗	Matte Matt	Prism
			✗			(●●●)	✗	✗	Matte Matt 6 mm	
			✗				✗	✗	Grip Grip	
	(●●)			✗		(●●●)	✗	✗	Matte Matt	Raw
			✗				✗	✗	Matte Matt 6 mm	
		(●●)				✗	✗	✗	Grip Grip	
		(●●)				✗	✗	✗	Matte Matt	Trust
			✗			✗	✗	✗	Grip Grip	
			✗			✗	✗	✗	Matte Matt	Venti Boost

Outdoor ± 20mm

\* Anti-slip performance is guaranteed at the time of delivery of the product. - Le prestazioni anti-slip vengono garantite al momento della consegna del prodotto.  
(●), PTV ≥ 36 Wet on demand - su richiesta (●●), P3 on demand - su richiesta (●●●), C2 on demand - su richiesta

PRODUCT FINDER



SURFACE RANGE



COMPANY



COLLECTIONS



LARGE SIZES



TECHNICAL SPECIFICATIONS



## V-SHADE, COLOUR-SHADING

The V-Shade classification indicates the colour shading level of a product, that is to say the chromatic and/or surface variation among tiles of the same collection. A strong colour shading is typical of ceramic collections that reproduce natural stones and marble. A moderate colour shading is typical of ceramic collections for which a homogeneous chromatic surface is an aesthetic feature of contemporary design.

La classification VShade indique le niveau de gradation du produit, c'est-à-dire de variation chromatique et/ou superficielle entre des dalles d'une même collection. Une forte variation est conseillée lorsque l'on utilise une collection qui rappelle des matériaux naturels comme la pierre et le marbre. Des variations de tons plus modérées caractérisent des collections où l'homogénéité chromatique superficielle est une qualité esthétique ou véritable indice de design contemporain.

La clasificación V-Shade indica el nivel de variación de tono del producto, o de variación cromática y/o superficial que existe entre las baldosas de una misma colección. Una variación de tono significativa es indicada en las colecciones que evocan materiales naturales como la piedra y el mármol. Variaciones de tono más moderadas caracterizan colecciones en que la homogeneidad cromática superficial es un valor estético índice de un diseño contemporáneo.

**V1** **Uniform appearance**  
Aspetto uniforme  
Aspect uniforme  
Gleichmäßiges Erscheinungsbild  
Aspecto uniforme  
Однородный вид

**V2** **Slight variation**  
Variazione minima  
Variation minimale  
Leichte Abweichung  
Variación mínima  
Минимальная Неоднородность

**V3** **Moderate variation**  
Variazione moderata  
Variation Modérée  
Mäßige Abweichung  
Variación moderada  
Умеренная Неоднородность

**V4** **Substantial variation**  
Variazione sostanziale  
Variation substantielle  
Grundlegende Abweichung  
Variación sustancial  
Значительная Неоднородность

Serie / Series Série / Serie Serie / Серия	Colore / Colour Couleur / Farbe Color / Цвет	Stonallizzazione / Colour-shading Denuancement / Marmorierung Contraste / Цветовое отличие
--	--	--

<b>3D WALL</b>	Wall tiles	<b>V1</b>
<b>3D WALL CARVE</b>	Wall tiles	<b>V1</b>
<b>AIX</b>	Porcelain & Wall tiles	<b>V3 Porcelain tiles</b> <b>V2 Wall tiles</b>
<b>APLOMB</b>	Wall tiles	<b>V1</b>
<b>ARTY</b>	Wall tiles	<b>V1</b>
<b>AXI</b>	Porcelain tiles	White Pine <b>V2</b>
		Silver Fir <b>V2</b>
		Grey Timber <b>V2</b>
		Dark Oak <b>V2</b>
		Golden Oak <b>V3</b>
	Brown Chestnut <b>V3</b>	
<b>BLAZE</b>	Porcelain & Wall tiles	<b>V3</b>
<b>BOOST</b>	Porcelain & Wall tiles	<b>V3 Porcelain tiles</b> <b>V2 Wall tiles</b>
<b>BOOST NATURAL</b>	Porcelain & Wall tiles	<b>V2 Porcelain tiles</b> <b>V2 Wall tiles</b>
<b>BOOST MIX</b>	Porcelain tiles	<b>V3</b>
<b>BOOST PRO</b>	Porcelain & Wall tiles	<b>V3 Porcelain tiles</b> <b>V2 Wall tiles</b>
<b>BOOST STONE</b>	Porcelain tiles	<b>V2</b>
<b>BRAVE</b>	Porcelain & Wall tiles	<b>V2</b>
<b>BRICK</b>	Wall tiles	Calacatta Extra <b>V3</b>
		Statuario Select <b>V3</b>
		Carrara <b>V2</b>
		Silver Dream <b>V2</b>
		Persian Jade <b>V3</b>
	Royal Gold <b>V3</b>	
	White Bevel <b>V1</b>	
<b>DOLMEN PRO</b>	Porcelain tiles	Genere <b>V2</b>
		Grigio <b>V2</b>
		Rosso <b>V2</b>
		Mix <b>V4</b>
<b>DWELL</b>	Porcelain & Wall tiles	<b>V2</b>
<b>ETIC</b>	Porcelain tiles	Ebano <b>V2</b>
		Noce <b>V3</b>
		Palissandro <b>V3</b>
		Rovere <b>V3</b>
		Rovere Bianco <b>V2</b>
	Rovere Grigio <b>V3</b>	
	Ulivo <b>V3</b>	
<b>ETIC PRO</b>	Porcelain tiles	<b>V3</b>
<b>EWALL</b>	Wall tiles	<b>V2</b>
<b>EXENCE</b>	Porcelain tiles	<b>V2</b>
<b>HEARTWOOD</b>	Porcelain tiles	<b>V3</b>
<b>KLIF</b>	Porcelain & Wall tiles	<b>V3 Porcelain tiles</b> <b>V2 Wall tiles</b>

V-SHADE, colour-shading - Stonallizzazione V-SHADE - Denuancement, V-SHADE - V-SHADE, Marmorierung - Contraste, V-SHADE - Цветовое отличие, V-SHADE

La classificazione VShade indica il livello di stonallizzazione del prodotto, ovvero di variazione cromatica e/o superficiale che intercorre tra le piastrelle di una stessa collezione. Una forte stonallizzazione è indicata nelle collezioni che richiamano materiali naturali come la pietra e il marmo. Stonallizzazioni più moderate caratterizzano collezioni in cui l'omogeneità cromatica superficiale è un valore estetico indice di un design contemporaneo.

Die Klassifizierung V-Shade gibt das Niveau des Farbverlaufs des Produktes oder die Abweichung des Farbtons und/oder Oberfläche unter den Fliesen der gleichen Kollektion an. Starke Farbunterschiede zeigen sich vor allem in Kollektionen, die natürliche Materialien wie Stein und Marmor nachempfinden. Weniger starke Farbunterschiede kennzeichnen Kollektionen deren Farbhomogenität der Oberflächen ein ästhetischer Wert des zeitgenössischen Designs darstellen.

Классификация V-Shade указывает на уровень цветовой или фактурной неоднородности плиток, т.е. на отличия по цвету или по фактуре между плитками одной коллекции. Высокая цветовая неоднородность присутствует на плитках, имитирующих природные материалы, например, камень или мрамор. Умеренная неоднородность цвета наблюдается на плитках, предназначенных для оформления интерьеров или экстерьеров в современном стиле.

Serie / Series Série / Serie Serie / Серия	Colore / Colour Couleur / Farbe Color / Цвет	Stonallizzazione / Colour-shading Denuancement / Marmorierung Contraste / Цветовое отличие
--	--	--

<b>KONE</b>	Porcelain tiles	<b>V2</b>
<b>MARK</b>	Porcelain tiles	<b>V3</b>
<b>LIMS</b>	Porcelain & Wall tiles	<b>V3 Porcelain tiles</b> <b>V2 Wall tiles</b>
<b>MARVEL</b>	Porcelain & Wall tiles	<b>V2</b>
<b>MARVEL DREAM</b>	Porcelain & Wall tiles	Brazil Green <b>V3</b>
		Ultramarine <b>V3</b>
		Crystal Beauty <b>V2</b>
		Bianco Fantastico <b>V2</b>
		Morning Sky <b>V3</b>
		Grigio Intenso <b>V2</b>
		Black Atlantis <b>V2</b>
		Royal Calacatta <b>V3</b>
		Imperial White <b>V2</b>
		Elegant Sable <b>V2</b>
<b>MARVEL EDGE</b>	Porcelain & Wall tiles	<b>V2</b>
<b>MARVEL GEMS</b>	Porcelain tiles	Gris Supreme <b>V2</b>
		Absolute Brown <b>V3</b>
		Gold Onyx <b>V3</b>
		Agata Azul <b>V3</b>
		Red Luxury <b>V3</b>
<b>MARVEL PRO</b>	Porcelain & Wall tiles	Statuario Select <b>V3</b>
		Grey Fleury <b>V3</b>
		Noir St. Laurent <b>V2</b>
		Crema Delicato <b>V2</b>
		Travertino Alabastrino <b>V2</b>
		Travertino Silver <b>V2</b>
		Calacatta Delicato <b>V2</b>
		Calacatta Prestigio <b>V2</b>
		Statuario Supremo <b>V2</b>
		Calacatta Imperiale <b>V3</b>
<b>MARVEL SHINE</b>	Porcelain & Wall tiles	<b>V2</b>
<b>MARVEL STONE</b>	Porcelain & Wall tiles	<b>V2</b>
<b>MEK</b>	Porcelain & Wall tiles	<b>V2</b>
<b>NID</b>	Porcelain tiles	<b>V2</b>
<b>NORDE</b>	Porcelain tiles	<b>V3</b>
<b>PRISM</b>	Porcelain & Wall tiles	<b>V2</b>
<b>RAW</b>	Porcelain & Wall tiles	<b>V3</b>
<b>TRUST</b>	Porcelain tiles	<b>V3</b>
<b>VENTI BOOST</b>	Porcelain tiles	Classic Carpet 1, 2, 3 <b>V2</b>
		Blue Carpet 1, 2, 3 <b>V2</b>
		Carpet 1, 2, 3 Warm <b>V2</b>
		Carpet 1, 2, 3 Cold <b>V2</b>
		Classic Mix, Blue Mix <b>V4</b>
	Mix Warm, Mix Cold <b>V4</b>	

## DESTINATIONS OF USE / PORCELAIN TILES



## HEAVY COMMERCIAL

Malls, airports, places of worship, schools, museums, squares, hospitals, hotels - foyers, undergrounds, train stations, etc.

## COMMERCIALI PESANTI

Mall, aeroporti, luoghi di culto, scuole, musei, piazze, ospedali, hotel - hall di ingresso, metropolitane, stazioni ferroviarie, ecc...

## COMMERCIAL LOURD

Centres commerciaux, aéroports, lieux de culte, écoles, musées, places, hôpitaux, hôtels - halls d'entrée, stations de métro, gares, etc...

## STARK BEANSPRUCHTE GEWERBEBEREICHE

Enkaufszentren, Flughäfen, Kulturstätten, Schulen, Museen, Plätze, Krankenhäuser, Hotels - Eingangshallen, U-Bahn-Stationen, Bahnhöfe etc.

## COMERCIALES PESADOS

Centros comerciales, aeropuertos, lugares de culto, colegios, museos, plazas, hospitales, hoteles - hall de entrada, metros, estaciones de trenes, etc. ...

## ОБЩЕСТВЕННЫЕ ОБЪЕКТЫ С ВЫСОКОЙ ПОСЕЩАЕМОСТЬЮ

Торговые центры, аэропорты, церкви, школы, музеи, площади, больницы, входные холлы отелей, метро, вокзалы и т.п.



## MEDIUM COMMERCIAL

Restaurants, offices, shops, public restrooms, public offices, hotels except for foyers, business lounges, etc. with the exception of mandatory passageways and areas subject to the transit of trolleys with hard wheels or highly concentrated loads.

## COMMERCIALI MEDI

Ristoranti, uffici, negozi, bagni pubblici, uffici pubblici, hotel - ad esclusione delle hall di ingresso, business lounge, etc. a esclusione di passaggi obbligati e zone soggetto a transito di carrelli con ruote dure ovvero elevati carichi concentrati.

## BÂTIMENT COMMERCIAL MOYEN

Restaurants, bureaux, boutiques, sanitaires publics, bureaux publics, hôtels - à l'exception des halls d'entrée, business lounges, etc..., ainsi que des points de passage obligés et des zones soumises au passage de chariots à roues dures ou de charges ponctuelles lourdes.

## GEWERBEBEREICHE MIT MITTLERER BEANSPRUCHUNG

Restaurants, Büros, Geschäfte, öffentliche Toiletten, öffentliche Ämter, Hotels mit Ausnahme der Eingangshallen, Business Lounges etc., unter Ausschluss obligatorischer Passagen sowie mit harten Rädern befahrener bzw. hohen, konzentrierten Lasten ausgesetzter Bereiche.

## COMERCIALES MEDIOS

Restaurants, oficinas, tiendas, baños públicos, oficinas públicas, hoteles - excluidos los pasillos de entradas, salas de negocios, etc. excluidos los pasos obligatorios y áreas sujetas al tránsito de carretillas con ruedas duras o cargas altamente concentradas.

## ОБЩЕСТВЕННЫЕ ОБЪЕКТЫ СО СРЕДНЕЙ ПОСЕЩАЕМОСТЬЮ

Рестораны, офисы, магазины, общественные туалеты, общественные учреждения, отели (кроме входных холлов), бизнес-залы и т.п., за исключением общих проходов и мест, где предвидятся сосредоточенные нагрузки или перемещение тележек на жестких колесах.



## RESIDENTIAL

Bedrooms, living rooms, studies, private kitchens, private bathrooms, etc.

## RESIDENZIALI

Camere da letto, soggiorni, studi, cucine private, bagni privati...

## BÂTIMENT D'HABITATION

Chambres de nuit, salons, pièces à usage professionnel, cuisines, salles de bains...

## WOHNUNGSBAU

Schlafzimmer, Wohnzimmer, Arbeitszimmer, private Küchen und Bäder...

## RESIDENCIALES

Dormitorios, salones, salas de estar, cocinas particulares, cuartos de baño particulares...

## ЖИЛЫЕ ПОМЕЩЕНИЯ

Спальни, гостиные, рабочие кабинеты, домашние кухни, домашние ванные комнаты и т.п.

\* Polished and silk finishes are recommended for low-stress residential or commercial floors where anti-slip performance is not required. The surface's shine and superior ease of cleaning are the result of in-depth studies and extensive technical research aimed at ensuring its durability over time. If the product is in direct contact with the outside, use moisture and dirt absorption devices to prevent scratches. - Le finiture lappata e silk sono indicate per pavimenti residenziali o commerciali poco sollecitati, laddove non siano richieste prestazioni anticivolo. La lucentezza e l'elevata facilità di pulizia della superficie sono frutto di studi approfonditi e accurate ricerche tecniche volte a garantirne la persistenza nel tempo. Se il prodotto è a diretto contatto con l'esterno, prevedere dei dispositivi di assorbimento dell'umidità e dello sporco per prevenire la formazione di graffi. - Les finitions rodée et soyeuse conviennent aux sols résidentiels ou commerciaux à faibles contraintes, où la performance antidérapante n'est pas requise. La brillance et la grande facilité de nettoyage de la surface sont le résultat d'études approfondies et de recherches techniques précises visant à assurer sa persistance dans le temps. Si le produit est en contact direct avec l'extérieur, prévoyez des dispositifs d'absorption de l'humidité et de la saleté pour éviter la formation de rayures. - Die Oberflächenversionen Gläppt und Silk eignen sich für Bodenbeläge in Wohnbereichen bzw. in gering beanspruchten Gewerberäumen, wenn keine Rutschfestigkeit erforderlich ist. Der Glanz und die einfache Reinigung der Oberfläche sind das Resultat eingehender technischer Studien, mit denen die langfristige Beständigkeit sichergestellt wurde. Kommt das Produkt direkt mit der externen Umgebung in Kontakt, so sind Feuchtigkeit und Schmutz mit geeigneten Mitteln aufzunehmen, um Kratzer zu vermeiden. - Los acabados lapeados y silk son adecuados para pavimentos residenciales y comerciales con poco tráfico, donde no se requiere un efecto antideslizante. El brillo y la gran facilidad de limpieza de la superficie son el resultado de profundos estudios e investigaciones técnicas precisas para asegurar su persistencia en el tiempo. Si el producto está en contacto directo con el exterior, proporcionar dispositivos de absorción de humedad y suciedad para evitar arañazos. - Лаппированная поверхность и поверхность Silk рекомендованы для полов жилых и коммерческих помещений с невысокой интенсивностью эксплуатации, в которых от покрытия не требуется характеристик сопротивления скольжению. Блеск и легкая очищаемость являются результатом глубоких исследований, направленных на создание долговечного материала. Если плитка находится в непосредственном контакте с наружной средой, необходимо предусмотреть устройства поглощения влаги и грязи во избежание образования царапин.

Recommended products by intended use - Prodotti consigliati per destinazione d'uso - Produits conseillés par destination d'usage - empfohlene produkte nach zweckbestimmung - Productos aconsejados según los usos previstos - изделия, рекомендуемые в зависимости от назначения

Destinations of use - Destinazione d'uso - Destinations d'usage - Zweckbestimmungen - Uso previsto - назначение

Porcelain tiles - Gres porcellanato - Grès cérame - Feinsteinzeug - Gres porcelánico - Керамогранит

## RECOMMENDED PRODUCTS BY INTENDED USE

Heavy commercial, medium commercial and residential. Commerciale pesante, commerciale medio e residenziale.		H M L
<b>AIX</b>	matte/grip/outdoor	✘ 9/20 mm
<b>AXI</b>	matte/outdoor	✘ 9,5/20 mm
<b>BLAZE</b>	matte/grip/outdoor	✘ 9/20 mm
<b>BOOST</b>	matte/grip/outdoor	✘ 9/20 mm
<b>BOOST MIX</b>	matte/grip/outdoor	✘ 9/20 mm
<b>BOOST NATURAL</b>	matte/grip/outdoor	✘ 9/20 mm
<b>BOOST PRO</b>	matte/grip/outdoor	✘ 9/20 mm
<b>BOOST STONE</b>	matte/grip/outdoor	✘ 9/20 mm
<b>BRAVE</b>	matte/grip/outdoor	✘ 9/20 mm
<b>DOLMEN PRO</b>	matte/grip/outdoor	✘ 9/20 mm
<b>DWELL</b>	matte/outdoor	✘ 9/20 mm
<b>ETIC</b>	matte	✘ 9/9,5 mm
<b>ETIC PRO</b>	matte/grip/outdoor	✘ 9/20 mm
<b>EVOLVE</b>	matte	✘ 9 mm
<b>EXENCE</b>	matte/grip/outdoor	✘ 9/20 mm
<b>GROUNDTRACK</b>	matte	✘ 9 mm
<b>HEARTWOOD</b>	matte	✘ 9 mm
<b>KLIF</b>	matte/grip/outdoor	✘ 9/20 mm
<b>KONE</b>	matte/grip/outdoor	✘ 9/20 mm
<b>LIMS</b>	matte/grip/outdoor	✘ 9/20 mm
<b>MARK</b>	matte	✘ 9 mm
<b>MARVEL</b>	matte	✘ 9 mm
<b>MARVEL DREAM</b>	matte	✘ 9 mm
<b>MARVEL EDGE</b>	matte	✘ 9 mm
<b>MARVEL GEMS</b>	matte	✘ 9 mm
<b>MARVEL PRO</b>	matte/textured	✘ 9 mm
<b>MARVEL SHINE</b>	matte	✘ 9 mm
<b>MARVEL STONE</b>	matte	✘ 9 mm
<b>MEK</b>	matte	✘ 9 mm
<b>NID</b>	matte	✘ 9 mm
<b>NORDE</b>	matte/grip/roccia/outdoor	✘ 9/20 mm
<b>PRISM</b>	matte/grip/outdoor	✘ 9/20 mm
<b>RAW</b>	matte/grip/outdoor	✘ 9/20 mm
<b>TRUST</b>	matte/grip/outdoor	✘ 9/20/30 mm
<b>VENTI BOOST</b>	unglazed matte	✘ 9 mm

Medium commercial and residential. Commerciale medio e residenziale.		M L
<b>BLAZE</b>	matte/polished *	✘ 6/9 mm
<b>BOOST</b>	matte	✘ 6 mm
<b>BOOST MIX</b>	matte	✘ 6 mm
<b>BOOST NATURAL</b>	matte	✘ 6 mm
<b>BOOST PRO</b>	matte	✘ 6 mm
<b>BOOST STONE</b>	matte	✘ 6 mm
<b>DWELL</b>	polished *	✘ 9 mm
<b>LIMS</b>	matte	✘ 6 mm
<b>MARK</b>	polished *	✘ 9 mm
<b>MARVEL</b>	matte/polished *	✘ 6/9 mm
<b>MARVEL EDGE</b>	polished *	✘ 6/9 mm
<b>MARVEL DREAM</b>	matte/polished *	✘ 6/9 mm
<b>MARVEL PRO</b>	matte/polished *	✘ 6/9 mm
<b>MARVEL SHINE</b>	matte/polished/silk *	✘ 6/9 mm
<b>MARVEL STONE</b>	matte/polished *	✘ 6/9 mm
<b>PRISM</b>	matte/silk *	✘ 6/9 mm
<b>RAW</b>	matte	✘ 6 mm
<b>VENTI BOOST</b>	glazed matte	✘ 9 mm

## INDEX



## PRODUCT FINDER



## SURFACE RANGE



## COMPANY



## COLLECTIONS



## LARGE SIZES



## TECHNICAL SPECIFICATIONS



## INTENDED USES FOR OUTDOORS

## PORCELAIN TILES

INTENDED USES FOR OUTDOORS		
<p><b>INDUSTRIAL AND/OR COMMERCIAL AREAS FOR VEHICLES</b></p> <p>Squares, public car parks, filling stations, paving for forklift trucks, pallet jacks, trailer trucks, buses, industrial platforms, etc.</p> <p>INSTALLATION METHOD</p> <p>Laying with adhesives using the "double buttering" method.</p> <p>PRODUCT PORCELAIN TILES <sup>(1)</sup></p> <p>Porcelain tile with a thickness greater than or equal to 20 mm with anti-slip finish <sup>(1)</sup>.</p>	<p><b>RESIDENTIAL AREAS FOR VEHICLES</b></p> <p>Outdoor courtyards, private homes, apartment complex parking lots (garages), etc. Pavements used only by cars.</p> <p>INSTALLATION METHOD</p> <p>Laying with adhesives using the "double buttering" method.</p> <p>PRODUCT PORCELAIN TILES <sup>(1)</sup></p> <p>Porcelain tiles with anti-slip finish <sup>(1)</sup>.</p> <p><b>AREE RESIDENZIALI CARRABILI</b></p> <p>Cortili esterni abitazioni private, parcheggi condominiali (garage interni), ecc... Pavimentazioni a transito esclusivo di autovetture.</p> <p>TIPO DI POSA</p> <p>Posa con adesivi con il metodo della "doppia spalmatura".</p> <p>PRODOTTO GRES PORCELLANATO <sup>(1)</sup></p> <p>Gres porcellanato a spessore superiore o uguale a 20mm con finitura anti-scivolo <sup>(1)</sup>.</p>	<p><b>AREAS FOR PEDESTRIANS ONLY</b></p> <p>Patios, gardens and walkways, terraces, balconies, urban pedestrian areas, etc.</p> <p>INSTALLATION METHOD</p> <p>"Dry" laying (on grass, sand, and gravel) and raised installation</p> <p>PRODUCT PORCELAIN TILES <sup>(1)</sup></p> <p>Porcelain tile with a thickness greater than or equal to 20 mm with anti-slip finish <sup>(1)</sup>.</p> <p>–</p> <p>INSTALLATION METHOD</p> <p>Laying with adhesives using the "double buttering" method.</p> <p>PRODUCT PORCELAIN TILES <sup>(1)</sup></p> <p>Porcelain tiles with anti-slip finish<sup>(1)</sup>.</p>
<p><b>AREE INDUSTRIALI E/O COMMERCIALI CARRABILI</b></p> <p>Piazze, parcheggi pubblici, stazioni di rifornimento, pavimentazioni con transito di carrelli elevatori, transpallet, autarticolati, autobus, piattaforme industriali, ecc... TIPO DI POSA</p> <p>Posa con adesivi con il metodo della "doppia spalmatura".</p> <p>PRODOTTO GRES PORCELLANATO <sup>(1)</sup></p> <p>Gres porcellanato a spessore superiore o uguale a 20mm con finitura anti-scivolo <sup>(1)</sup>.</p>	<p><b>ZONES RÉSIDENTIELLES AVEC PASSAGE DE VÉHICULES</b></p> <p>Cours externes d'habitations individuelles, parkings d'immeuble (garages intérieurs), etc... Sols pour passage exclusivement de voitures.</p> <p>TYPE DE POSE</p> <p>Pose à l'aide de colles par la méthode du "double encollage".</p> <p>PRODUIT GRÈS CÉRAME <sup>(1)</sup></p> <p>Grès cérame à finition anti-glisse <sup>(1)</sup>.</p>	<p><b>AREE SOLO PEDONABILI</b></p> <p>Patii, giardini e camminamenti, terrazze, balconi, aree urbane pedonali, ecc... TIPO DI POSA</p> <p>Posa "a secco" (su erba, sabbia e ghiaia) e posa sopraelevata.</p> <p>PRODOTTO GRES PORCELLANATO <sup>(1)</sup></p> <p>Gres porcellanato a spessore superiore o uguale a 20mm con finitura anti-scivolo <sup>(1)</sup>.</p>
<p><b>ZONES INDUSTRIELLES ET/OU ZONES COMMERCIALES AVEC PASSAGE DE VÉHICULES</b></p> <p>Places, parkings publics, stations-services, sols avec passage de chariots élévateurs, transpallettes, véhicules articulés, autobus, plateformes industrielles, etc... TYPE DE POSE</p> <p>Pose à l'aide de colles par la méthode du "double encollage".</p> <p>PRODUIT GRÈS CÉRAME <sup>(1)</sup></p> <p>Grès cérame d'épaisseur supérieure ou égale à 20 mm à finition anti-glisse<sup>(1)</sup>.</p>	<p><b>ZONES UNIQUEMENT PIÉTONNES</b></p> <p>Patios, jardins et allées, terrasses, balcons, zones urbaines piétonnes, etc... TYPE DE POSE</p> <p>Pose "à sec" (sur herbe, sable ou graviers) et pose surélevée.</p> <p>PRODUIT GRÈS CÉRAME <sup>(1)</sup></p> <p>Grès cérame d'épaisseur supérieure ou égale à 20 mm à finition anti-glisse<sup>(1)</sup>.</p> <p>–</p> <p>TYPE DE POSE</p> <p>Pose à l'aide de colles par la méthode du "double encollage".</p> <p>PRODUIT GRÈS CÉRAME <sup>(1)</sup></p> <p>Grès cérame à finition anti-glisse <sup>(1)</sup>.</p>	<p><b>REINE FUSSGÄNGERBEREICHE</b></p> <p>Innenhöfe, Gärten und Gehwege, Terrassen, Balkone, städtische Fußgängerzonen etc.</p> <p>VERLEGESYSTEM</p> <p>"Trockenverlegung" (auf Gras, Sand und Kies) und erhöhte Verlegung.</p> <p>PRODUKT FEINSTEINZEUG <sup>(1)</sup></p> <p>Feinsteinzeug mit Stärke gleich oder über 20 mm und rutschfester Oberfläche<sup>(1)</sup>.</p> <p>–</p> <p>VERLEGESYSTEM</p> <p>Verlegung mit beidseitig aufgebrachtem Kleber (Buttering-Floating-Verfahren)</p> <p>PRODUKT FEINSTEINZEUG <sup>(1)</sup></p> <p>Feinsteinzeug mit rutschfester Oberfläche<sup>(1)</sup>.</p>
<p><b>BEFAHRBARE INDUSTRIE- UND/ODER GEWERBEFLÄCHEN</b></p> <p>Plätze, öffentliche Parkplätze, Tankstellen, von Gabelstaplern, Handgabelhubwagen, Sattelschleppern, Bussen befahrene Böden, Industriepattformen etc. VERLEGESYSTEM</p> <p>Verlegung mit beidseitig aufgebrachtem Kleber (Buttering-Floating-Verfahren)</p> <p>PRODUKT FEINSTEINZEUG <sup>(1)</sup></p> <p>Feinsteinzeug mit Stärke gleich oder über 20 mm und rutschfester Oberfläche<sup>(1)</sup>.</p>	<p><b>AREAS RESIDENCIALES TRAFICABLES</b></p> <p>Patios exteriores de viviendas particulares, apartamientos de bloques multifamiliares (garajes interiores), etc... Pavimentos de tráfico exclusivo de automóviles.</p> <p>TIPO DE COLOCACIÓN</p> <p>Colocación con materiales de agarre según el método de "doble encolado".</p> <p>PRODUCTO GRES PORCELÁNICO <sup>(1)</sup></p> <p>Gres porcelánico con acabado antideslizante <sup>(1)</sup>.</p>	<p><b>POOL EDGES</b></p> <p>INSTALLATION METHOD</p> <p>Laying with adhesives using the "double buttering" method.</p> <p>PRODUCT Porcelain tiles <sup>(1)</sup></p> <p>Porcelain tiles with anti-slip finish <sup>(1)</sup>.</p>
<p><b>AREAS INDUSTRIALES Y/O COMERCIALES TRAFICABLES</b></p> <p>Centros comerciales, aeropuertos, lugares de culto, colegios, museos, plazas, hospitales, hoteles – hall de entrada, metros, estaciones de trenes, etc... TIPO DE COLOCACIÓN</p> <p>Colocación con materiales de agarre según el método de "doble encolado".</p> <p>PRODUCTO GRES PORCELÁNICO <sup>(1)</sup></p> <p>Gres porcelánico con acabado antideslizante<sup>(1)</sup>.</p>	<p><b>PROЕЗЖИЕ УЧАСТКИ ПРИ ЖИЛЫХ ОБЪЕКТАХ</b></p> <p>Дворы частных домов, парковки многоквартирных домов (внутренние гаражи) и т.п. Покрытия, предназначенные для проезда только легковых автомобилей. ТИП УКЛАДКИ</p> <p>Клеевая укладка с нанесением клея на монтажную сторону плитки и на облицовываемое основание</p> <p>ИЗДЕЛИЕ КЕРАМОГРАНИТ <sup>(1)</sup></p> <p>Керамогранит с противоскользящей поверхностью<sup>(1)</sup>.</p>	<p><b>BORDS DE PISCINE</b></p> <p>TYPE DE POSE</p> <p>Pose à l'aide de colles par la méthode du "double encollage".</p> <p>PRODUIT GRÈS CÉRAME <sup>(1)</sup></p> <p>Grès cérame à finition anti-glisse <sup>(1)</sup>.</p>
<p><b>ПРОМЫШЛЕННЫЕ И (ИЛИ) КОММЕРЧЕСКИЕ ПРОЕЗЖИЕ УЧАСТКИ</b></p> <p>Площадки, общественные парковки, заправочные станции, покрытия для проезда погрузчиков, гидравлических тележек, фур, автобусов, промышленные платформы и т.д. ТИП УКЛАДКИ</p> <p>Клеевая укладка с нанесением клея на монтажную сторону плитки и на облицовываемое основание</p> <p>ИЗДЕЛИЕ КЕРАМОГРАНИТ <sup>(1)</sup></p> <p>Керамогранит толщиной 20 мм или больше с противоскользящей поверхностью<sup>(1)</sup>.</p>	<p><b>PEŞEHODLUNE UЧАСТКИ</b></p> <p>Патии, сады, садовые дорожки, террасы, балконы, городские пешеходные площадки и т.п. ТИП УКЛАДКИ</p> <p>Сухая бесклеевая укладка (на траву, песок, гравий) и укладка на опоры</p> <p>ИЗДЕЛИЕ КЕРАМОГРАНИТ <sup>(1)</sup></p> <p>Керамогранит толщиной 20 мм или больше с противоскользящей поверхностью<sup>(1)</sup>.</p> <p>–</p> <p>ТИП УКЛАДКИ</p> <p>Клеевая укладка с нанесением клея на монтажную сторону плитки и на облицовываемое основание.</p> <p>ИЗДЕЛИЕ КЕРАМОГРАНИТ <sup>(1)</sup></p> <p>Керамогранит с противоскользящей поверхностью<sup>(1)</sup>.</p>	<p><b>BORDES DE PISCINE</b></p> <p>TYPE DE POSE</p> <p>Pose à l'aide de colles par la méthode du "double encollage".</p> <p>PRODUIT GRÈS CÉRAME <sup>(1)</sup></p> <p>Grès cérame à finition anti-glisse <sup>(1)</sup>.</p>
<p><b>КРАЯ БАССЕЙНОВ</b></p> <p>ТИП УКЛАДКИ</p> <p>Клеевая укладка с нанесением клея на монтажную сторону плитки и на облицовываемое основание</p> <p>ИЗДЕЛИЕ КЕРАМОГРАНИТ <sup>(1)</sup></p> <p>Керамогранит с противоскользящей поверхностью<sup>(1)</sup>.</p>	<p><b>IMPORANT NOTES - WARNINGS - NOTE IMPORTANTI - AVVERTENZE</b></p> <p>NOTES IMPORTANTES - AVERTISSEMENTS- WICHTIGE HINWEISE - ZUR BEACHTUNG</p> <p>NOTAS IMPORTANTES - ADVERTENCIAS - ВАЖНЫЕ ПРИМЕЧАНИЯ - ПРЕДУПРЕЖДЕНИЯ</p>	<p><b>TIPO DI POSA</b></p> <p>Posa con adesivi con il metodo della "doppia spalmatura".</p> <p>PRODOTTO GRES PORCELLANATO <sup>(1)</sup></p> <p>Gres porcellanato con finitura anti-scivolo <sup>(1)</sup>.</p>
<p><b>IMPORTANT NOTES - WARNINGS - NOTE IMPORTANTI - AVVERTENZE</b></p> <p>NOTES IMPORTANTES - AVERTISSEMENTS- WICHTIGE HINWEISE - ZUR BEACHTUNG</p> <p>NOTAS IMPORTANTES - ADVERTENCIAS - ВАЖНЫЕ ПРИМЕЧАНИЯ - ПРЕДУПРЕЖДЕНИЯ</p>	<p><b>TIPO DI POSA</b></p> <p>Posa con adesivi con il metodo della "doppia spalmatura".</p> <p>PRODOTTO GRES PORCELLANATO <sup>(1)</sup></p> <p>Gres porcellanato con finitura anti-scivolo <sup>(1)</sup>.</p>	<p><b>TIPO DI POSA</b></p> <p>Posa con adesivi con il metodo della "doppia spalmatura".</p> <p>PRODOTTO GRES PORCELLANATO <sup>(1)</sup></p> <p>Gres porcellanato con finitura anti-scivolo <sup>(1)</sup>.</p>
<p><b>These are general instructions: it is always necessary to check the resistance of the tiling with respect to the maximum expected loads</b> – Queste sono indicazioni di carattere generale: occorre sempre verificare la resistenza della piastrellatura rispetto ai carichi massimi di progetto. – Ces indications sont de caractère général : il faut toujours vérifier la résistance des carreaux par rapport aux charges maximales prévues dans le projet. – Dies sind allgemeine Hinweise. In jedem Fall ist die Beständigkeit des Fliesenbelags gegen die maximal zu erwartenden Lasten stets zu prüfen. – Estas son indicaciones de carácter general: siempre es necesario verificar la resistencia del embaldosado respecto a las cargas máximas del proyecto. – Данные указания являются указаниями общего характера: рекомендуется всегда проверять стойкость плиточного покрытия с учетом максимальных расчетных нагрузок.</p>	<p><b>These are general instructions: it is always necessary to check the resistance of the tiling with respect to the maximum expected loads</b> – Queste sono indicazioni di carattere generale: occorre sempre verificare la resistenza della piastrellatura rispetto ai carichi massimi di progetto. – Ces indications sont de caractère général : il faut toujours vérifier la résistance des carreaux par rapport aux charges maximales prévues dans le projet. – Dies sind allgemeine Hinweise. In jedem Fall ist die Beständigkeit des Fliesenbelags gegen die maximal zu erwartenden Lasten stets zu prüfen. – Estas son indicaciones de carácter general: siempre es necesario verificar la resistencia del embaldosado respecto a las cargas máximas del proyecto. – Данные указания являются указаниями общего характера: рекомендуется всегда проверять стойкость плиточного покрытия с учетом максимальных расчетных нагрузок.</p>	<p><b>These are general instructions: it is always necessary to check the resistance of the tiling with respect to the maximum expected loads</b> – Queste sono indicazioni di carattere generale: occorre sempre verificare la resistenza della piastrellatura rispetto ai carichi massimi di progetto. – Ces indications sont de caractère général : il faut toujours vérifier la résistance des carreaux par rapport aux charges maximales prévues dans le projet. – Dies sind allgemeine Hinweise. In jedem Fall ist die Beständigkeit des Fliesenbelags gegen die maximal zu erwartenden Lasten stets zu prüfen. – Estas son indicaciones de carácter general: siempre es necesario verificar la resistencia del embaldosado respecto a las cargas máximas del proyecto. – Данные указания являются указаниями общего характера: рекомендуется всегда проверять стойкость плиточного покрытия с учетом максимальных расчетных нагрузок.</p>
<p><b>Intended uses for outdoors</b> – Destinazione d'uso per esterni – Destination à usage extérieur – Zweckbestimmungen für Außenbereiche – Uso previsto para exteriores – Назначение для наружных пространств</p>	<p><b>Intended uses for outdoors</b> – Destinazione d'uso per esterni – Destination à usage extérieur – Zweckbestimmungen für Außenbereiche – Uso previsto para exteriores – Назначение для наружных пространств</p>	<p><b>Intended uses for outdoors</b> – Destinazione d'uso per esterni – Destination à usage extérieur – Zweckbestimmungen für Außenbereiche – Uso previsto para exteriores – Назначение для наружных пространств</p>
<p><b>Porcelain tiles</b> – Gres porcellanato – Grès cérame – Feinsteinzeug – Gres porcelánico – Керамогранит</p>	<p><b>Porcelain tiles</b> – Gres porcellanato – Grès cérame – Feinsteinzeug – Gres porcelánico – Керамогранит</p>	<p><b>Porcelain tiles</b> – Gres porcellanato – Grès cérame – Feinsteinzeug – Gres porcelánico – Керамогранит</p>

PORCELAIN TILES FOR OUTDOORS		
<b>AIX</b>	grip/outdoor	± 9/20 mm
<b>AXI</b>	textured/outdoor	± 9,5/20 mm
<b>BLAZE</b>	grip/outdoor	± 9/20 mm
<b>BOOST</b>	grip/outdoor	± 9/20 mm
<b>BOOST MIX</b>	grip/outdoor	± 9/20 mm
<b>BOOST NATURAL</b>	grip/outdoor	± 9/20 mm
<b>BOOST PRO</b>	grip/outdoor	± 9/20 mm
<b>BOOST STONE</b>	grip/outdoor	± 9/20 mm
<b>BRAVE</b>	grip/outdoor	± 9/20 mm
<b>DOLMEN PRO</b>	grip/outdoor	± 9/20 mm
<b>ETIC PRO</b>	grip/outdoor	± 9/20 mm
<b>EXENCE</b>	grip/outdoor	± 9/20 mm
<b>GROUNDTRACK</b>	matte	± 9 mm
<b>KLIF</b>	grip/outdoor	± 9/20 mm
<b>KONE</b>	grip	± 9 mm
<b>LIMS</b>	grip/outdoor	± 9/20 mm
<b>MARVEL PRO</b>	textured	± 9 mm
<b>MARVEL STONE</b>	textured/outdoor	± 9/20 mm
<b>NORDE</b>	grip/roccia/outdoor	± 9/20 mm
<b>PRISM</b>	grip/outdoor	± 9/20 mm
<b>RAW</b>	grip/outdoor	± 9/20 mm
<b>TRUST</b>	grip/outdoor	± 9/20/30 mm

## INDEX



## PRODUCT FINDER



## SURFACE RANGE



## COMPANY



## COLLECTIONS



## LARGE SIZES



## TECHNICAL SPECIFICATIONS





TRIM TILES

± 9 mm - 9,5 mm

INDOOR

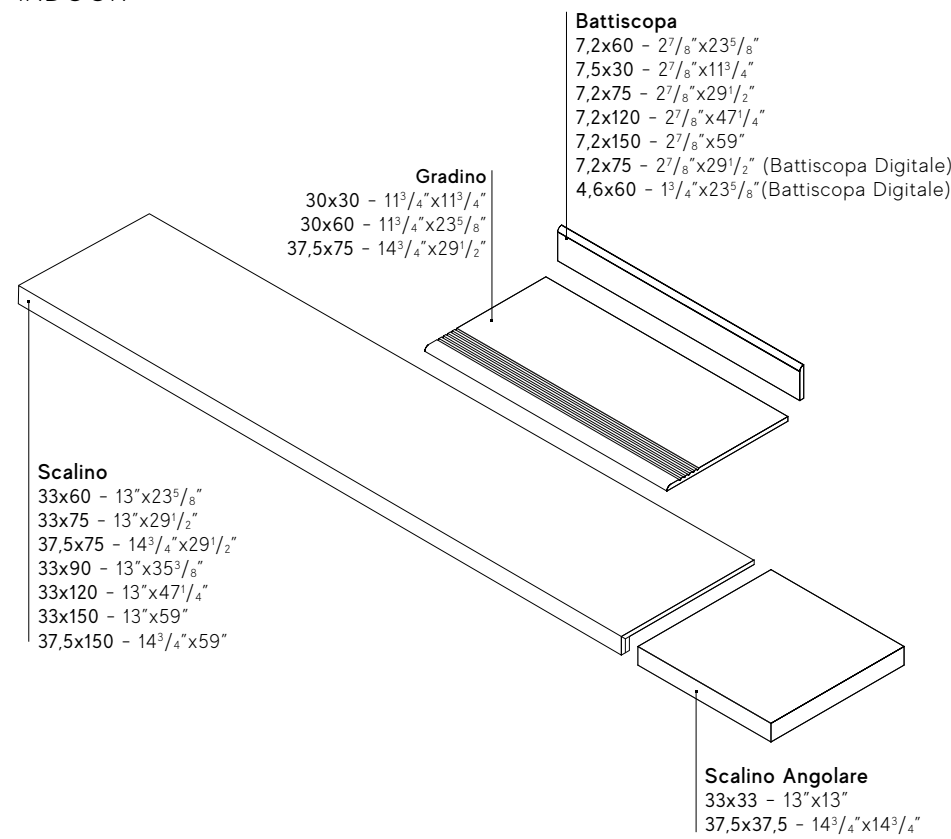

OUTDOOR

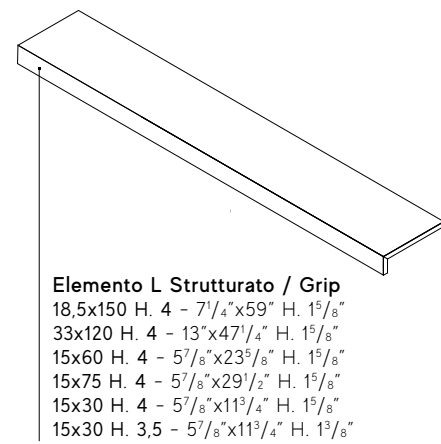

Battiscopa Sagomato

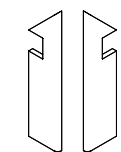

**Battiscopa Sag. Scala Dx / Sx**  
 7,5x30 - 3"x11<sup>3</sup>/<sub>4</sub>"  
 7,2x30 - 2<sup>7</sup>/<sub>8</sub>"x11<sup>3</sup>/<sub>4</sub>"

TRIM TILES

± 9 mm - 9,5 mm

GRADINO

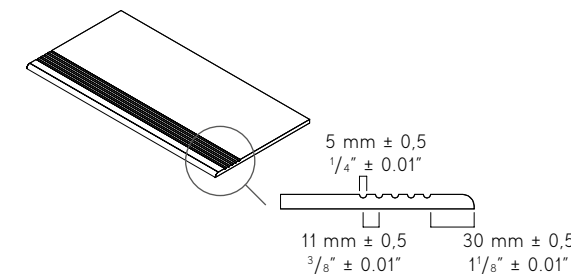

BATTISCOPA SAGOMATO

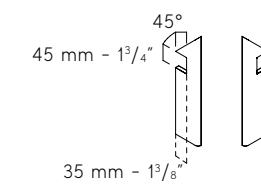

SCALINO

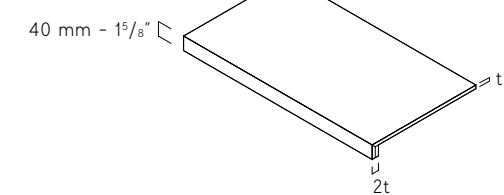

ELEMENTO L STRUTTURATO/GRIP

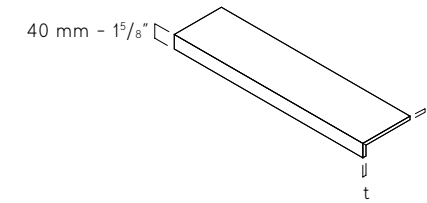

SCALINO ANGOLARE

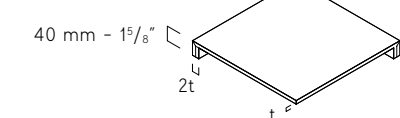
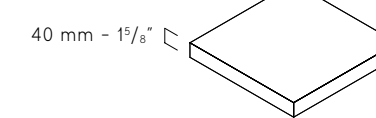

WOOD LOOK

INDOOR

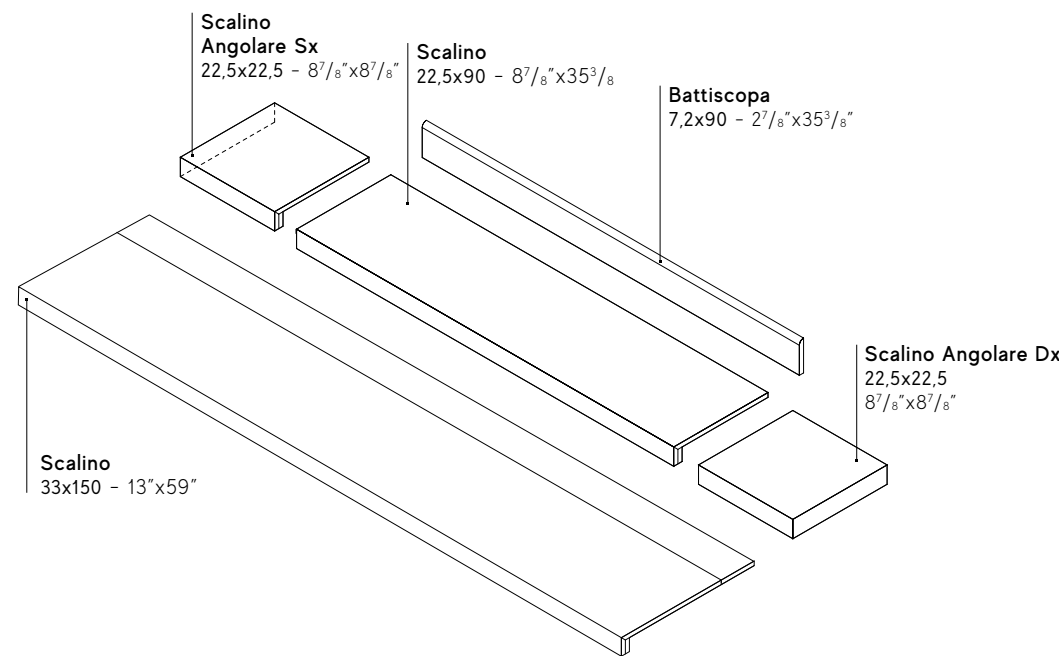

OUTDOOR

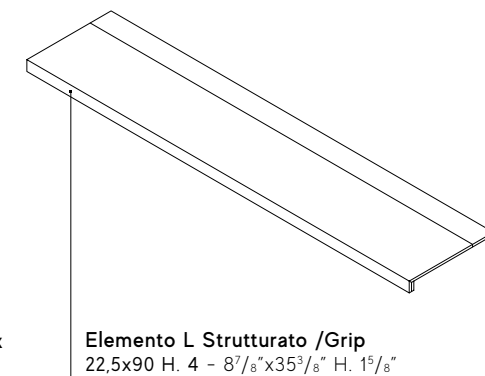

TRIM TILES

± 20 mm

LINEARE

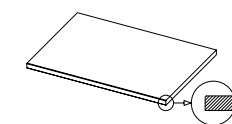

ROUND ♦

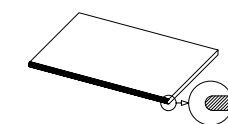

ROUND 60 ♦

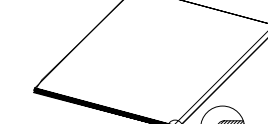

GRADINO ROUND 60 ♦

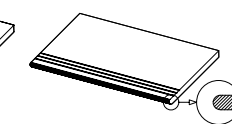

ELEMENTO L ♦

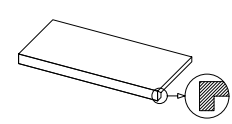

ALZATA

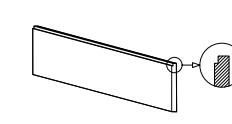

TOP

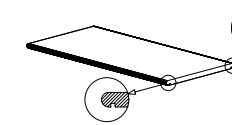

COSTA DESIGN

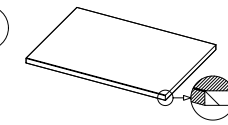

BORDO PISCINA ♦

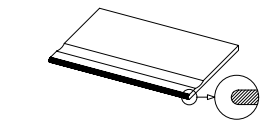

GRIGLIA ♦

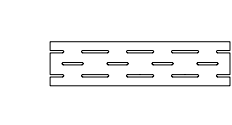

CURVE

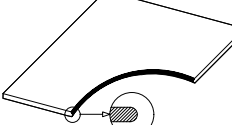

SMUSSATO

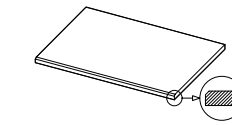

♦ Right/left angular elements are available / Sono disponibili gli elementi angolari dx/sx

LASTRA STEPS

Round + Alzata

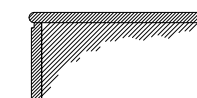

Lineare + Alzata

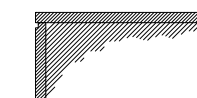

Elemento L + Alzata

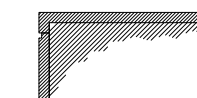

t = thickness

INDEX



PRODUCT  
FINDER



SURFACE  
RANGE



COMPANY



COLLECTIONS



LARGE SIZES



TECHNICAL  
SPECIFICATIONS



TRIM TILES  $\nabla$  20 mm  
PORCELAIN TILES

	Lineare	Round		Round Angolare Dx/Sx		Round 60 Angolare		Gradino Round Angolare Dx/Sx		Gradino Round		Elemento L Angolare		Elemento L Angolare Dx/Sx		Alzata		Top		Costa Design		Bordo Piscina Angolare Dx/Sx		Bordo Piscina		Griglia Angolare Dx/Sx		Griglia		Curve		Smussato	
	30x60 cm 111/2x231/2"	40x80 cm 151/2x311/2"	45x90 cm 171/2x351/2"	60x90 cm 231/2x351/2"	30x120 cm 111/2x231/2"	33x120 cm 13x471/2"	30x60 cm 111/2x231/2"	40x80 cm 151/2x311/2"	45x90 cm 171/2x351/2"	60x90 cm 231/2x351/2"	30x60 cm 111/2x231/2"	33x120 cm 13x471/2"	33x80 cm 13x311/2"	33x90 cm 13x351/2"	33x33 cm 13x31"	33x33 cm 13x31"	20x90 cm 71/2x351/2"	30x120 cm 111/2x231/2"	20x120 cm 71/2x471/2"	30x60 cm 111/2x231/2"	30x120 cm 111/2x231/2"	33x120 cm 13x471/2"	30x60 cm 111/2x231/2"	30x60 cm 111/2x231/2"	20x60 cm 71/2x231/2"	15x60 cm 51/2x231/2"	20x60 cm 71/2x231/2"	60x60 cm 231/2x231/2"	30x60 cm 111/2x231/2"	30x60 cm 111/2x231/2"			
		DX	SX	DX	SX	DX	SX	DX	SX	DX	SX	DX	SX	DX	SX							DX	SX	DX	SX	DX	SX	DX	SX				
AIX	•																																
AXI			•																														
BLAZE	•																																
BOOST	•																																
BOOST MIX	•																																
BOOST NATURAL	•																																
BOOST PRO	•																																
BOOST STONE	•																																
BRAVE	•																																
DOLMEN PRO																																	
ETIC PRO																																	
EXENCE																																	
KLIF	•																																
LIMS	•																																
MARVEL STONE																																	
NORDE	•																																
PRISM																																	
RAW																																	
TRUST	•																																

PRODUCT FINDER >

SURFACE RANGE >

COMPANY >

COLLECTIONS >

LARGE SIZES >

TECHNICAL SPECIFICATIONS >

# Wall Tiles Technical Specification

Complies with	EN 14411 (ISO 13006)	Appendix	L	Group	BIII
Conforme alla norma	EN 14411 (ISO 13006)	Appendice	L	Gruppo	BIII
Conforme à la norme	EN 14411 (ISO 13006)	Appendice	L	Groupe	BIII
Entsprechend	EN 14411 (ISO 13006)	Anhang	L	Gruppe	BIII
Conforme a la norma	EN 14411 (ISO 13006)	Apéndice	L	Grupo	BIII
Соответствует норме	EN 14411 (ISO 13006)	Приложение	L	Группа	BIII

- (\*) **The permissible deviation, in % or mm, of the average size for each tile (2 or 4 sides) from work size (WS).**  
Deviazione ammissibile, in % oppure mm, della dimensione media di ogni piastrella (2 oppure 4 lati) dalla dimensione di fabbricazione (WS).
- (\*\*) **The permissible deviation, in % or mm, of the average thickness for each tile from the work size thickness (WS).**  
Deviazione ammissibile, in % oppure mm, dello spessore medio di ogni piastrella dallo spessore riportato nella dimensione di fabbricazione (WS).
- (\*\*\*) **The maximum permissible deviation from straightness, in % or mm, related to the corresponding work sizes (WS).**  
Deviazione massima ammissibile di rettilineità, in % oppure mm, in rapporto alle dimensioni di fabbricazione (WS) corrispondenti.
- (\*\*\*\*) **The maximum permissible deviation from rectangularity, in % or mm, related to the corresponding work sizes (WS).**  
Deviazione massima ammissibile di ortogonalità, in % oppure mm, in rapporto alle dimensioni di fabbricazione (WS) corrispondenti.
- c.c. **The maximum permissible deviation from centre curvature, in % or mm, related to diagonal calculated from the work sizes (WS).**  
Deviazione massima ammissibile della curvatura del centro, in % oppure mm, in rapporto alla diagonale calcolata secondo le dimensioni di fabbricazione (WS).
- e.c. **The maximum permissible deviation from edge curvature, in % or mm, related to the corresponding work sizes (WS).**  
Deviazione massima ammissibile della curvatura dello spigolo, in % oppure mm, in rapporto alle dimensioni di fabbricazione (WS) corrispondenti.
- w. **The maximum permissible deviation from warpage, in % or mm, related to diagonal calculated from the work sizes (WS).**  
Deviazione massima ammissibile dello svergolamento, in % oppure mm, in rapporto alla diagonale calcolata secondo le dimensioni di fabbricazione (WS).

## TECHNICAL SPECIFICATION SYMBOLS

Dimensions Dimensioni Dimensions Maße Tamaño Размер	ISO 10545-2		<b>Length and width</b> / Lunghezza e larghezza (*) Longuer et largeur / Länge und Breite / Longitud y anchura / Размеры сторон
			<b>Thickness</b> / Spessore (**) Epaisseur / Stärke / Grosor / Толщина
			<b>Straightness of sides</b> / Rettilineità degli spigoli (***) Rectitude des aretes / Kantengeradheit / Rectilineidad de las aristas / Кривизна сторон
			<b>Rectangularity</b> / Ortogonalità (****) Orthogonalite / Rechtwinkligkeit / Ortogonalidad / Косоугольность
			<b>SURFACE FLATNESS</b> / PLANARITÀ Planimetrie / Ebenflächigkeit / Planaridad / Кривизна лицевой поверхности
	ISO 10545-3		<b>Water absorption</b> / Massa d'acqua assorbita Masse d'eau absorbée / Aufgenommene Wassermasse / Peso de agua absorbida / Водопоглощение
	ISO 10545-4		<b>BREAKING STRENGTH</b> / Sforzo di rottura Force de rupture / Bruchlast / Esfuerzo de ruptura / Усилие на излом
			<b>Modulus of rupture</b> / Resistenza alla flessione Résistance à la flexion / Biegefestigkeit / Resistencia a la flexión / Устойчивость к изгибу
	ISO 10545-8		<b>Coefficient of thermal linear expansion</b> / Coefficiente di dilatazione termica lineare Coefficient de dilatation thermique linéique / Lineare thermische Dehnung Coeficiente de dilatación térmica lineal / Коэффициент линейного расширения
Physical properties Proprietà fisiche Proprietes physiques Physikalische Eigenschaften Propiedades físicas Физические характеристики	ISO 10545-9		<b>Thermal shock resistance</b> / Resistenza agli sbalzi termici Résistance aux écarts de température / Temperaturwechselbeständigkeit Resistencia a los cambios de temperatura / Устойчивость к перепаду температур
	ISO 10545-10		<b>Moisture expansion (in mm/m)</b> / Dilatazione all'umidità (in mm/m) Dilatation à l'humidité (en mm/m) / Feuchtigkeitsausdehnung (in mm/m) Dilatación por la humedad (en mm/m) / Расширение под воздействием влаги (в мм/м)
	ISO 10545-11		<b>Crazing resistance</b> / Resistenza al cavillo Résistance aux craquelurés / Haarriss-Beständigkeit / Resistencia a grietas / Устойчивость эмали к краquelюру (старению)
	EN 1348		<b>Bond strength/adhesion for improved cementitious adhesives</b> / Adesione a trazione con adesivi cementizi migliorati Adhérence par traction avec des ciments-colle améliorés / Scherfestigkeit mit verbesserten zementhaltigen Klebern Adherencia a tracción con adhesivos cementosos mejorados Прочность на растяжение при приклеивании улучшенными цементными клеями
	-		<b>Reaction to fire</b> / Reazione al fuoco Réaction au feu / Brandverhalten / Reacción al fuego / Огнестойкость
Chemical properties Proprietà chimiche Proprietes chimiques Chemische eigenschaften Propiedades quimicas Химические характеристики	ISO 10545-13		<b>Resistance to household chemicals and swimming pool salts</b> Resistenza ai prodotti chimici di uso domestico ed agli additivi per piscina Résistance aux produits chimiques à usage domestique et aux adjuvants pour piscine Beständigkeit gegen Haushaltschemikalien und Badewasserzusätze Resistencia a los productos químicos de uso doméstico Стойкость к химикатам, используемым в быту и для бассейнов
			<b>Resistance to low concentrations of acids and alkalis</b> / Resistenza a basse concentrazioni di acidi e alcali Résistance aux acides et aux alcalis à basse concentration / Beständigkeit gegen niedrigkonzentrierte Säuren und Laugen Resistencia a los ácidos y bases de baja concentración / Сопротивление кислотам и щелочам низкой концентрации
			<b>Resistance to high concentrations of acids and alkalis</b> / Resistenza ad alte concentrazioni di acidi e alcali Résistance aux acides et aux alcalis à haute concentration / Beständigkeit gegen hochkonzentrierte Säuren und Laugen Resistencia a los ácidos y bases de alta concentración / Сопротивление кислотам и щелочам низкой концентрации
	ISO 10545-14		<b>Resistance to STAINING</b> / Resistenza alle macchie Résistance aux taches / Widerstand gegen Fleckenbildung / Resistencia a las manchas / Устойчивость эмали к загрязнению
	ISO 10545-15		<b>Release of dangerous substances: Cadmium (in mg/dm²) and Lead (in mg/dm²)</b> Rilascio di sostanze pericolose: Cadmio (in mg/dm²) e Piombo (in mg/dm²) Emission de substances dangereuses: Cadmium (mg/dm²) et Plomb (mg/dm²) Emission von gefährlichen Stoffen: Cadmium (mg/dm²) und Blei (mg/dm²) Emisión de sustancias peligrosas: Cadmio (mg/dm²) y Plomo (mg/dm²) Выделение вредных веществ: кадмия (в мг/дм²) и свинца (в мг/дм²)

Technical features - Caratteristiche tecniche - Caractéristiques techniques - Technische Daten - Características técnicas - Технические характеристики

INDEX



PRODUCT  
FINDER



SURFACE  
RANGE



COMPANY



COLLECTIONS



LARGE SIZES



TECHNICAL  
SPECIFICATIONS





GENERAL PACKING AND WEIGHT

PORCELAIN TILES

Serie Series Série Serie Серия	Formato Size Format Format Formato	Pezzi per scatola Pieces per carton Pièces par boîte Stückzahl pro Karton Piezas por caja шт. в коробке	M <sup>2</sup> per scatola Sq mts per carton M <sup>2</sup> par boîte Karton pro Palette M <sup>2</sup> por caja M <sup>2</sup> в коробке	Box per pallet Box per pallet Boites per palette Karton pro Palette Cajas por palet Коробок на палете	Peso per scatola (Kg)* Weight x ctn. (Kg)* Poids x boîte (Kg)* Gewicht pro Karton (Kg)* Peso por caja (Kg)* шт. вес коробки*	M <sup>2</sup> per pallet Sq mts per pallet M <sup>2</sup> par palette Om. pro Palette M <sup>2</sup> por palet M <sup>2</sup> на палете	Peso per pallet (Kg)* Weight x pal. (Kg)* Poids x pal. (Kg)* Gewicht pro Palette (Kg)* Peso por palet (Kg)* вес малета*
AIX	120x120 ▲	2	2,88	20	58,00	57,60	1.160,00
	75x150	2	2,25	18	47,36	40,50	852,48
	75x75	2	1,13 0	42	23,67	47,25	994,14
	45x90	2	1,130	48	22,16	54,00	1.063,68
	37,5x75 grip	4	1,130	48	23,68	54,00	1.136,64
	22,5x45,3	12	1,220	34	23,70	41,59	805,80
	22,5x22,5	20	1,013	42	19,40	42,53	814,80
	120x120 20 mm ▲	1	1,440	20	67,66	28,80	1.353,20
	60x90 20 mm	2	1,080	18	48,50	19,44	873,00
	60x60 20 mm	2	0,720	30	33,00	21,60	990,00
AXI	22,5x45,4 20 mm	5	0,510	40	20,43	20,40	817,20
	22,5x22,5 20 mm	11	0,560	40	22,72	22,24	908,80
	22,5x90	6	1,220	36	25,20	43,74	907,20
	45x90 20 mm	2	0,810	27	37,00	21,87	999,00
	75x150	2	2,25	18	47,36	40,50	852,48
	75x75	2	1,130	42	23,68	47,25	994,14
	120x278 ▲	1	3,340	18	49,56	60,05	892,08
	120x120 ▲	2	2,880	20	58,00	57,60	1.160,00
	37,5x75	4	1,130	48	23,68	54,00	1.136,64
	120x120 20 mm ▲	1	1,440	20	67,66	28,80	1.353,20
BLAZE	60x60 20 mm	2	0,720	30	33,00	21,60	990,00
	160x320 ▲	1	5,120	14	72,00	71,68	1.008,00
	160x160 ▲	1	2,560	24	36,00	61,44	864,00
	120x278 ▲	1	3,340	18	49,56	60,05	892,08
	120x240 ▲	1	2,880	18	58,00	51,84	1.044,00
	120x120 ▲	2	2,880	20	58,00	57,60	1.160,00
	120x120 6 mm ▲	2	2,880	20	40,32	57,60	806,40
	60x120	2	1,44	35	30,00	50,40	1.050,00
	75x150	2	2,25	18	47,36	40,50	852,48
	75x75	2	1,130	42	23,68	47,25	994,14
BOOST	37,5x75	4	1,130	48	23,68	54,00	1.136,64
	60x60	3	1,080	40	20,01	43,20	800,40
	30x60	7	1,260	40	24,85	50,40	994,00
	120x240 20 mm ▲	1	2,880	9	134,00	25,92	1.206,00
	120x120 20 mm ▲	1	1,440	20	67,66	28,80	1.353,20
	60x120 20 mm	1	0,720	35	33,35	25,20	1.167,25
	90x90 20 mm	1	0,810	18	37,60	14,58	676,80
	60x60 20 mm	2	0,720	30	33,00	21,60	990,00
	120x278 ▲	1	3,34	18	49,56	60,05	892,08
	120x120 ▲	2	2,88	20	58,00	57,60	1.160,00
BOOST MIX	60x120	2	1,44	35	30,00	50,40	1.050,00
	60x60	3	1,08	40	21,57	43,20	862,80
	30x60	7	1,26	40	24,85	50,40	994,00
	120x120 20 mm ▲	1	1,44	20	67,66	28,80	1.353,20
	60x120 20 mm	1	0,72	35	33,35	25,20	1.167,25
	60x60 20 mm	2	0,72	30	33,00	21,60	990,00
	120x278 ▲	1	3,340	18	49,56	60,05	892,08
	120x120 ▲	2	2,880	20	58,00	57,60	1.160,00
	60x120	2	1,44	35	30,00	50,40	1.050,00
	60x60	3	1,08	40	21,57	43,20	862,80
BOOST NATURAL	30x60	7	1,26	40	24,85	50,40	994,00
	120x120 20 mm ▲	1	1,44	20	67,66	28,80	1.353,20
	60x60 20 mm	2	0,72	30	33,00	21,60	990,00
	160x320 ▲	1	5,120	14	72,00	71,68	1.008,00
	160x160 ▲	1	2,560	24	36,00	61,44	864,00
	120x278 ▲	1	3,340	18	49,56	60,05	892,08
	120x240 ▲	1	2,880	18	58,00	51,84	1.044,00
	120x120 ▲	2	2,880	20	58,00	57,60	1.160,00
	120x120 6 mm	2	2,880	20	40,32	57,60	806,40
	60x120	2	1,440	35	30,00	50,40	1.050,00
BOOST PRO	75x150	2	2,25	18	47,36	40,50	852,48
	75x75	2	1,130	42	23,68	47,25	994,14
	37,5x75	4	1,130	48	23,68	54,00	1.136,64
	60x60	3	1,080	40	21,57	43,20	862,80
	30x60	7	1,260	40	24,85	50,40	994,00
	120x120 20 mm ▲	1	1,440	20	67,66	28,80	1.353,20
	60x120 20 mm	1	0,720	35	33,35	25,20	1.167,25
	90x90 20 mm	1	0,810	18	37,60	14,58	676,80
	60x60 20 mm	2	0,720	30	33,00	21,60	990,00
	120x278 ▲	1	3,34	18	49,56	60,05	892,08
BOOST STONE	120x120 ▲	2	2,88	20	58,00	57,60	1.160,00
	60x120	2	1,44	35	30,00	50,40	1.050,00
	60x60	3	1,08	40	21,57	43,20	862,80
	30x60	7	1,26	40	24,85	50,40	994,00
	120x120 20 mm ▲	1	1,44	20	67,66	28,80	1.353,20
	60x120 20 mm	1	0,72	35	33,35	25,20	1.167,25
	60x60 20 mm	2	0,72	30	33,00	21,60	990,00
	120x278 ▲	1	3,340	18	49,56	60,05	892,08
	120x240 ▲	1	2,880	18	58,00	51,84	1.044,00
	120x120 ▲	2	2,880	20	58,00	57,60	1.160,00

\* +/- 10% The reported values do not include the weight of pallets. - I valori riportati non comprendono il peso dei pallet. - +/- 10% Les valeurs indiquées ne comprennent pas le poids des palettes. - +/- 10% - Die genannten Werte verstehen sich ohne das Gewicht der Paletten. - +/- 10% Los valores indicados no incluyen el peso de los palets. - +/- 10% Указанные значения не включают вес поддонов.  
▲ Packaging on pallets also available on a-frames(see page 474) - Imballaggio su pallet, disponibile anche in imballo su cavalletto a pag. 474 - Emballage sur palette, également disponible page 474 - Verpackung auf Palette, auch auf Bock erhältlich. - Seite 474 - Embalaje paletizado, también disponible en embalaje sobre caballetes en la página 474 - Упаковка на поддонах, возможна также упаковка на специальных подставках-стойках - стр. 474  
February 2022  
Reported data can be subject to variations throughout the year, present values are updated on the date of catalogue printing.  
I dati riportati possono subire delle variazioni nel corso dell'anno, i valori sono aggiornati al mese di stampa.  
General packing and weight - Imballi e Pesi - Emballage et poids - Verpackung und Gewicht - Pesos y embalaje - Упаковка и вес

PORCELAIN TILES

Serie Series Série Serie Серия	Formato Size Format Format Formato	Pezzi per scatola Pieces per carton Pièces par boîte Stückzahl pro Karton Piezas por caja шт. в коробке	M <sup>2</sup> per scatola Sq mts per carton M <sup>2</sup> par boîte Karton pro Palette M <sup>2</sup> por caja M <sup>2</sup> в коробке	Box per pallet Box per pallet Boites per palette Karton pro Palette Cajas por palet Коробок на палете	Peso per scatola (Kg)* Weight x ctn. (Kg)* Poids x boîte (Kg)* Gewicht pro Karton (Kg)* Peso por caja (Kg)* шт. вес коробки*	M <sup>2</sup> per pallet Sq mts per pallet M <sup>2</sup> par palette Om. pro Palette M <sup>2</sup> por palet M <sup>2</sup> на палете	Peso per pallet (Kg)* Weight x pal. (Kg)* Poids x pal. (Kg)* Gewicht pro Palette (Kg)* Peso por palet (Kg)* вес малета*
BRAVE	75x150	2	2,250	18	47,36	40,50	852,48
	75x75	2	1,130	42	23,68	47,25	994,14
	45x90	3	1,220	36	24,50	43,74	882,00
	60x60	3	1,080	40	21,23	43,20	849,20
	30x60	7	1,260	40	23,27	50,40	930,80
	30x60 grip	7	1,260	40	24,85	50,40	994,00
	120x120 20 mm ▲	1	1,440	20	67,66	28,80	1.353,20
	60x120 20 mm	1	0,720	35	33,35	25,20	1.167,25
	45x90 20 mm	2	0,810	27	37,00	21,87	999,00
	60x60 20 mm	2	0,720	30	33,00	21,60	990,00
DOLMEN PRO	37,5x75	4	1,130	48	23,68	54,00	1.136,64
	22,5x45,3	12	1,220	34	23,70	41,59	805,80
	22,5x22,5	20	1,010	42	19,40	42,53	814,80
	60x120 20 mm	1	0,720	35	33,35	25,20	1.167,25
	22,5x45,4 20 mm	5	0,510	40	20,43	20,40	817,20
	22,5x22,5 20 mm	11	0,556	40	22,72	22,24	908,80
	60x60	3	1,080	40	21,23	43,20	849,20
	30x60	7	1,260	40	24,85	50,40	994,00
	120x120 ▲	2	2,880	20	58,00	57,60	1.160,00
	22,5x90	6	1,220	36	25,20	43,74	907,20
ETIC	15x90	9	1,220	36	26,60	43,74	957,60
	25x150	3	1,130	30	23,68	33,75	710,00
	22,5x90	6	1,220	36	25,20	43,74	907,20
	15x90	10	1,350	36	28,00	48,60	1.008,00
	30x120 20mm	2	0,720	36	33,00	25,92	1.188,00
	18,5x150	4	1,110	40	23,68	44,40	947,20
	20x120	6	1,440	42	29,90	60,48	1.255,80
	30x120 20mm	2	0,720	36	33,00	25,92	1.188,00
	30x30	12	1,080	30	22,00	32,40	660,00
	18,5x150	4	1,110	40	23,68	44,40	947,20
HEARTWOOD	20x120	6	1,440	42	31,10	60,48	1.306,20
	75x150	2	2,25	18	47,36	40,50	852,48
	75x75	2	1,130	42	23,68	47,25	994,14
	37,5x75	4	1,130	48	23,68	54,00	1.136,64
	90x90 20 mm	1	0,810	18	37,60	14,58	676,80
	45x90 20 mm	2	0,810	27	34,85	21,87	940,95
	75x150	2	2,250	18	47,36	40,50	852,48
	75x75	2	1,130	42	23,68	47,25	994,14
	60x60	3	1,080	40	20,61	43,20	824,40
	30x60	7	1,260	40	24,85	50,40	994,00
KONE	120x240	1	2,880	18	58,00	51,84	1.044,00
	120x120 ▲	2	2,880	20	58,00	57,60	1.160,00
	120x278 ▲	1	3,340	18	49,56	60,05	892,08
	120x120 ▲	2	2,880	20	58,00	57,60	1.160,00
	75x150	2	2,250	18	47,36	40,50	852,48
	75x75	2	1,130	42	25,00	47,25	1.050,00
	37,5x75	4	1,130	48	25,00	54,00	1.200,00
	60x120 20 mm	1	0,720	35	33,35	25,20	1.167,25
	60x60 20 mm	2	0,720	30	33,00	21,60	990,00
	60x60	3	1,080	40	21,23	43,20	849,20
MARK	30x60	7	1,260	40	24,85	50,40	994,00
	160x320 ▲	1	5,120	14	72,00	71,68	1.008,00
	160x160 ▲	1	2,560	24	36,00	61,44	864,00
	120x278 ▲	1	3,334	18	49,56	60,05	892,08
	120x240 ▲	1	2,880	18	58,00	51,84	1.044,00
	120x120 ▲	2	2,880	20	58,00	57,60	1.160,00
	120x120 6 mm	2	2,880	20	40,32	57,60	806,40
	60x120	2	1,440	35	30,00	50,40	1.050,00
	75x150	2	2,250	18	47,36	40,50	852,48
	75x75	2	1,130	42	23,68	47,25	994,14
MARVEL	37,5x75	4	1,130	48	23,68	54,00	1.136,64
	60x60	3	1,220	36	25,40	43,74	914,40
	45x90	3	1,220	36	24,60	43,74	885,60
	60x60	3	1,080	40	21,23	43,20	849,20
	30x60	7	1,260	40	24,85	50,40	994,00
	120x278 ▲	1	3,340	18	49,56	60,05	892,08
	120x240 ▲	1	2,880	18	58,00	51,84	1.044,00
	120x120 ▲	2	2,880	20	58,00	57,60	1.160,00
	60x120	2	1,440	35	30,00	50,40	1.050,00
	75x150	2	2,25	18	47		

GENERAL PACKING AND WEIGHT

PORCELAIN TILES

WALL TILES

Serie Series Série Serie Серия	Formato Size Format Formato Размер	Pezzi per scatola Pieces per carton Stückzahl pro Karton Piezas por caja шт. в коробке	M² per scatola Sq mts per carton M² par boîte Om. pro Karton M² por caja M² в коробке	Box per pallet Box per pallet Boîtes per palette Karton pro Palette Cajas por palet Коробок на палете	Peso per scatola (Kg)* Weight x ctn. (Kg)* Poids x boîte (Kg)* Gewicht pro Karton (Kg)* Peso por caja (Kg)* щт. вес коробки*	M² per pallet Sq mts per pallet M² par palette Om. pro Palette M² por palet M² на палете	Peso per pallet (Kg)* Weight x pal. (Kg)* Poids x pal. (Kg)* Gewicht pro Palette (Kg)* Peso por palet (Kg)* вес малета*
MARVEL GEMS	60x60	3	1,080	40	21,23	43,20	849,20
	160x320 ▲	1	5,120	14	72,00	71,68	1,008,00
	160x160 ▲	1	2,560	24	36,00	61,44	864,00
	120x278 ▲	1	3,340	18	49,56	60,05	892,08
	120x240 ▲	1	2,880	18	58,00	51,84	1,044,00
	120x120 ▲	2	2,880	20	58,00	57,60	1,160,00
	60x120	2	1,440	35	30,00	50,40	1,050,00
MARVEL PRO	75x150	2	2,250	18	47,36	40,50	852,48
	75x75	2	1,130	42	23,68	47,25	994,56
	45x90	3	1,220	36	24,60	43,74	885,60
	60x60	3	1,080	40	21,23	43,20	849,20
	30x60	7	1,260	40	24,85	50,40	994,00
	160x320 ▲	1	5,120	14	72,00	71,68	1,008,00
	160x160 ▲	1	2,560	24	36,00	61,44	864,00
MARVEL SHINE	120x278 ▲	1	3,340	18	49,56	60,05	892,08
	120x240 ▲	1	2,880	18	58,00	51,84	1,044,00
	120x120 lapp ▲	2	2,880	20	57,00	57,60	1,140,00
	120x120 matt ▲	2	2,880	20	55,50	57,60	1,110,00
	60x120	2	1,440	35	30,00	50,40	1,050,00
	75x150	2	2,250	18	47,36	40,50	852,48
	75x75	2	1,130	42	23,68	47,25	994,56
	37,5x75	4	1,130	48	23,68	54,00	1,136,64
	60x60	3	1,080	40	21,23	43,20	849,20
	30x60	7	1,260	40	24,85	50,40	994,00
	160x320 ▲	1	5,120	14	72,00	71,68	1,008,00
	160x160 ▲	1	2,560	24	36,00	61,44	864,00
	120x278 ▲	1	3,340	18	49,56	60,05	892,08
	120x240 ▲	1	2,880	18	58,00	51,84	1,044,00
MARVEL STONE	120x120 ▲	2	2,880	20	58,00	57,60	1,160,00
	60x120	2	1,440	35	30,00	50,40	1,050,00
	75x150	2	2,250	18	47,36	40,50	852,48
	75x75	2	1,130	42	23,68	47,25	994,56
	45x90	3	1,220	36	24,60	43,74	885,60
	60x60	3	1,080	40	21,23	43,20	849,20
	30x60	7	1,260	40	24,85	50,40	994,00
	60x120 20 mm	1	0,720	35	33,35	25,20	1,167,25
	45x90	3	1,220	36	24,60	43,74	885,60
	60x60	3	1,080	40	21,23	43,20	849,20
	30x60	7	1,260	40	24,85	50,40	994,00
	25x150	3	1,130	30	23,68	33,75	710,40
	18,5x150	4	1,110	40	23,68	44,40	947,20
	15x90	10	1,350	36	26,67	48,60	960,12
NORDE	60x120	2	1,440	35	30,00	50,40	1,050,00
	60x60	3	1,080	40	21,57	43,20	862,80
	30x60	7	1,260	40	24,85	50,40	994,00
	60x120 20 mm	1	0,720	35	33,35	25,20	1,167,25
	60x90 20 mm	2	1,080	18	48,50	19,44	873,00
	80x80 20 mm	1	0,64	42	29,70	26,88	1,247,40
	60x60 20 mm	2	0,72	30	33,00	21,60	990,00
	60x120 grip	1	8,00	1	157,00	8,00	157,00
	120x278 ▲	1	3,340	18	49,56	60,05	892,08
	120x120 ▲	2	2,880	20	58,00	57,60	1,160,00
	60x120	2	1,440	35	30,00	50,40	1,050,00
	60x60	3	1,080	40	21,57	43,20	862,80
	30x60	7	1,260	40	24,85	50,40	994,00
	120x120 20 mm ▲	1	1,440	20	67,66	28,80	1,353,20
80x80 20 mm ▲	1	0,64	42	29,70	26,88	1,247,40	
RAW	120x278 ▲	1	3,340	18	49,56	60,05	892,08
	120x120 ▲	2	2,880	20	54,00	57,60	1,080,00
	75x150	2	2,250	18	47,36	40,50	852,48
	75x75	2	1,130	42	23,68	47,25	994,56
	37,5x75	4	1,130	48	23,68	54,00	1,136,64
	60x60	3	1,080	40	21,57	43,20	862,80
	30x60	7	1,260	40	24,85	50,40	994,00
	120x120 20 mm ▲	1	1,440	20	67,66	28,80	1,353,20
	60x120 20 mm ▲	1	0,720	35	33,35	25,20	1,167,25
	45x90	3	1,220	36	24,60	43,74	885,60
	60x60	3	1,080	40	20,01	43,20	800,40
	30x60	7	1,260	40	24,85	50,40	994,00
	60x120 20 mm	1	0,720	35	33,35	25,20	1,167,25
	45x90 20 mm	2	0,810	27	37,00	21,87	999,00
60x60 20 mm	2	0,720	30	33,00	21,60	990,00	
60x60 30 mm	1	0,360	40	23,68	14,40	947,20	
VENTI BOOST	20x20	30	1,200	56	23,90	67,20	1,338,40

Serie Series Série Serie Серия	Formato Size Format Formato Размер	Pezzi per scatola Pieces per carton Stückzahl pro Karton Piezas por caja шт. в коробке	M² per scatola Sq mts per carton M² par boîte Om. pro Karton M² por caja M² в коробке	Box per pallet Box per pallet Boîtes per palette Karton pro Palette Cajas por palet Коробок на палете	Peso per scatola (Kg)* Weight x ctn. (Kg)* Poids x boîte (Kg)* Gewicht pro Karton (Kg)* Peso por caja (Kg)* щт. вес коробки*	M² per pallet Sq mts per pallet M² par palette Om. pro Palette M² por palet M² на палете	Peso per pallet (Kg)* Weight x pal. (Kg)* Poids x pal. (Kg)* Gewicht pro Palette (Kg)* Peso por palet (Kg)* вес малета*	
3D WALL CARVE	40x80	4	1,280	54	20,28	69,12	1,095,12	
	50x120 matte	3	1,80	35	28,00	63,00	980,00	
	50x120 shiny	3	1,80	35	28,00	63,00	980,00	
	50x120 matte	3	1,80	30	30,75	54,00	922,50	
	40x80 matte	4	1,28	54	19,91	69,12	1,075,14	
	40x80 shiny	4	1,28	54	18,80	69,12	1,015,20	
	40x80 matte	4	1,28	48	20,06	61,44	962,88	
3D WALL DESIGN	40x80 shiny	4	1,28	48	21,20	61,44	1,017,60	
	30,5x56 matte	9	1,54	32	22,68	49,19	725,76	
	30,5x56 matte	8	1,37	32	26,00	43,72	832,00	
	40x80	4	1,280	54	19,00	69,12	1,026,00	
	3D Row 40x80	4	1,280	48	21,20	61,44	1,017,60	
	APLOMB	50x120	3	1,800	35	28,00	63,00	980,00
	ARTY Wall	40x80	4	1,280	54	20,57	69,12	1,110,78
ARTY Wall	3D Wave 40x80	4	1,280	48	21,20	61,44	1,017,60	
	BLAZE Wall	50x120	3	1,800	35	28,00	63,00	980,00
	BOOST Wall	40x80	4	1,280	54	18,80	69,12	1,015,20
	BOOST NATURAL Wall	3D Urban 40x80	4	1,280	48	21,20	61,44	1,017,60
		50x120	3	1,800	35	28,00	63,00	980,00
		40x80	4	1,280	54	18,80	69,12	1,015,20
		BOOST PRO Wall	3D Urban 40x80	4	1,280	48	21,20	61,44
40x80			4	1,280	54	19,28	69,12	1,041,12
3D Wave 40x80			4	1,280	48	21,20	61,44	1,017,60
3D Blade 40x80			4	1,280	48	21,20	61,44	1,017,60
DWELL Wall	40x80		4	1,280	54	18,80	69,12	1,015,20
KLIF Wall	40x80		4	1,280	54	18,89	69,12	1,020,06
3D Row 40x80	4		1,280	48	20,90	61,44	1,003,20	
LIMS Wall	40x80	4	1,280	54	19,00	69,12	1,026,00	
	MARVEL Wall	50x120	3	1,800	35	28,00	63,00	980,00
	30,5x91,5	5	1,400	42	22,50	58,59	945,00	
	40x80	4	1,280	54	20,28	69,12	1,095,12	
	30,5x56	9	1,540	32	24,03	49,19	768,96	
	8x31,5	20	0,500	84	8,10	42,34	680,40	
	MARVEL DREAM Wall	50x120	3	1,800	35	28,00	63,00	980,00
MARVEL EDGE Wall	50x120	3	1,800	35	28,00	63,00	980,00	
	40x80	4	1,280	54	19,00	69,12	1,026,00	
	MARVEL PRO Wall	50x120	3	1,800	35	28,00	63,00	980,00
	30,5x91,5	5	1,400	42	21,55	58,59	905,10	
	40x80	4	1,280	54	19,94	69,12	1,076,76	
	8x31,5	20	0,500	84	8,10	42,34	680,40	
	MARVEL SHINE Wall	50x120	3	1,800	35	28,00	63,00	980,00
MARVEL SHINE Wall	40x80	4	1,280	54	19,00	69,12	1,026,00	
	MARVEL STONE Wall	50x120	3	1,800	35	28,00	63,00	980,00
	40x80	4	1,280	54	19,00	69,12	1,026,00	
	MEK Wall	50x120	3	1,800	35	28,00	63,00	980,00
	PRISM Wall	3D Wall 50x120	3	1,800	30	30,75	54,00	922,50
	RAW Wall	50x120	3	1,800	35	28,00	63,00	980,00
	3D Scratch 50x120	3	1,800	30	30,75	54,00	922,50	

\* +/- 10% The reported values do not include the weight of pallets. - I valori riportati non comprendono il peso dei pallet. - +/- 10% Les valeurs indiquées ne comprennent pas le poids des palettes. - +/- 10% - Die genannten Werte verstehen sich ohne das Gewicht der Paletten. - +/- 10% Los valores indicados no incluyen el peso de los palés. - +/- 10% Указанные значения не включают вес поддонов.

▲ Packaging on pallets, also available on a-frames(see page 474) - Imballo su pallet, disponibile anche imballo su cavalletto a pag. 474 - Emballage sur palette, emballage sur chevalet également disponible page 474 - Verpackung auf Palette, auch auf Bock erhältlich - Seite 474 - Embalaje paletizado, también disponible en embalaje sobre caballetes en la página 474 - Упаковка на поддонах, возможна также упаковка на специальных подставках-стойках - стр. 474

February 2022  
Reported data can be subject to variations throughout the year, present values are updated on the date of catalogue printing.  
I dati riportati possono subire delle variazioni nel corso dell'anno, i valori sono aggiornati al mese di stampa.



## GENERAL PACKING AND WEIGHT

Imballo Packaging Boitage Verpackung Embalaje Упаковка	Codice AS400 AS400 Code Code AS400 Artikelcode AS 400 Código AS400 Код AS400	Dimensioni imballo Packaging Size Dimension Emballage Verpackungsmasse Dimensiones de Embalaje Размер Упаковки (cm)	Peso imballo Packaging weight Poids Emballage Verpackungsgewicht Peso Embalaje Вес Упаковки (kg)	Formati Slabs size Formats Formatgröße Formatos Размер Плит (cm)	Max N° pezzi Max N° slabs N° Max de pièces Anzahl der Platten Max N ° piezas Максимальное Количество Плит	MAX MQ Max Sqm M2 max Maximale qm Máx M² Макс. М²
<b>Pallet 120x120</b> Palette Palette Paleta Паллет	x	x	x	120x120x0,9 cm 120x120x2,0 cm	40 20	57,60 mq 28,8 mq
<b>Cavalletto di legno 120x120 Wooden A-Frame</b> Chevalet en Bois A-Bock Holz Caballete de Madera Деревянная А-Опора	IMCD	130x75x158(h) cm	60 kg	120x120x0,9 cm 120x120x2,0 cm	40 20	57,60 mq 28,8 mq
<b>Cassa di Legno 120x240 Wooden Crate</b> Caisse en Bois Holzbox Caja de Madera Деревянный Ящик	IMCA	268x136x36(h) cm	82kg	120x240x0,9 cm 120x240x2,0 cm	18 9	51,84 mq 25,92 mq
<b>Cavalletto di Legno 120x240 Wooden A-Frame</b> Chevalet en Bois A-Bock Holz Caballete de Madera Деревянная А-Опора	IMCE	250x75x159(h) cm	155kg	120x240x0,9 cm 120x240x2,0 cm	36 8	103,6 mq 23,04 mq
<b>Wooden Crate 120x278</b> Cassa di Legno Caisse en Bois Holzbox Caja de Madera Деревянный Ящик	IMCB	292x145x34(h) cm	88kg	120x278x0,6 cm	18	60,05 mq
<b>Wooden Crate Kit Endless (only for kit Endless) 120x278</b> Cassa di Legno Kit Endless (solo per Kit Endless) Caisse en Bois Kit Endless (que pour le Kit Endless) Holzbox Kit Endless (nur für Endless Kit) Caja de Madera Kit Endless (solo para el kit Endless) Деревянный Ящик для Kit Endless (только для Kit Endless)	A6NZ	305x135x21(h) cm	52,5kg	120x278x0,6 cm	5	16,68 mq
<b>Wooden A-Frame 120x278</b> Cavalletto di Legno Chevalet en Bois A-Bock Holz Caballete de Madera Деревянная А-Опора	IMCF	290x75x159(h) cm	96kg	120x278x0,6 cm	36	120 mq
<b>Wooden Crate 160x160</b> Cassa di Legno Caisse en Bois Holzbox Caja de Madera Деревянный Ящик	AØ5L	183x174x41(h) cm	91kg	160x160x0,6 cm	24	61,44 mq
<b>Wooden A-Frame 160x160</b> Cavalletto di Legno Chevalet en Bois A-Bock Holz Caballete de Madera Деревянная А-Опора	AØ5M	170x75x200(h) cm	103kg	160x160x0,6 cm	48	122,88 mq
<b>Wooden Crate 160x320 RT - 162x324</b> Cassa di legno Caisse en Bois Holzbox Caja de Madera Деревянный Ящик	IMCC	344x175x37(h) cm	139kg	160x320x0,6 cm 162x324x0,6 cm 162x324x1,2 cm 162x324x2,0 cm	14 14 8 4	71,68 mq 73,48 mq 40,96 mq 20,99 mq
<b>Wooden A-Frame 160x320 RT - 162x324</b> Cavalletto di legno Chevalet en Bois A-Bock Holz Caballete de Madera Деревянная А-Опора	IMCG	330x75x195(h) cm	206kg	160x320x0,6 cm 162x324x0,6 cm 162x324x1,2 cm 162x324x2,0 cm	42 42 22 12	215,04 mq 220,45 mq 112,64 mq 62,99 mq
<b>Iron A-Frame 160x320 RT - 162x324</b> Cavalletto di ferro Chevalet en Fer A-Bock Metall Caballete de Hierro Металлическая Опора	IMCH	330x75x195(h) cm	176kg	160x320x0,6 cm 162x324x0,6 cm 162x324x1,2 cm 162x324x2,0 cm	42 42 22 12	215,04 mq 220,45 mq 112,64 mq 62,99 mq
<b>Bundles 162x324</b> Only from Verona warehouse	-	-	30-40kg	160x320x0,6 cm 162x324x0,6 cm 162x324x1,2 cm 162x324x2,0 cm	- - 18 12	- - 94,50 mq 63,00 mq

**LARGE SIZES** - GRANDI FORMATI - Grands formats - Grossformate - Grandes Formatos - Большие Форматы  
1200x1200 / 1200x2400 / 300x2400 / 1200x2780 / 1600x1600 / 1600x3200 / 1620x3240  
48"x48" / 48"x96" / 12"x96" / 48"x110" / 63"x63" / 63"x126" / 63 3/4"x127 1/2"

CONTAINER 20 PIEDI - 20' Container - Conteneur 20' - 20' Container - Contenedor de 20 Pies - 20' Контейнер 5,90x2,32x2,35(h) m	
Full 1200x2400	nr. 11 casse - crates - caisses - Anzahl Holzboxen - cajas - количество ящиков 1200x2400 + 2 cavalletti - stands - chevalets - Anzahl A-Böcke - caballetes - количество опор 1200x2400
Full 1200x1200	nr. 16 casse - crates - caisses - Anzahl Holzboxen - cajas - количество ящиков 1200x1200x9 + 5 cavalletti - stands - chevalets - Anzahl A-Böcke - caballetes - количество опор 1200x1200x9
Full 1200x1200	nr. 12 casse - crates - caisses - Anzahl Holzboxen - cajas - количество ящиков 1200x1200x20 + 5 cavalletti - stands - chevalets - Anzahl A-Böcke - caballetes - количество опор 1200x1200x20
Full 1200x2780	nr. 6 cavalletti - stands - chevalets - Anzahl A-Böcke - caballetes - количество опор 1200x2780
Full 1200x2780	nr. 11 casse - crates - caisses - Anzahl Holzboxen - cajas - количество ящиков 1200x2780 + 2 cavalletti - stands - chevalets - Anzahl A-Böcke - caballetes - количество опор 1200x2780
Full 1600x3200	nr. 5 casse - crates - caisses - Anzahl Holzboxen - cajas - количество ящиков 1600x3200 (+ 4 spazi - spaces - places - Leerzeichen - espacios - пробелов 80cmx120 cm)
Full 1600x3200	nr. 3 cavalletti - stands - chevalets - Anzahl A-Böcke - caballetes - количество опор 1600x3200 (+ 4 spazi - spaces - places - Leerzeichen - espacios - пробелов 80cmx120cm)
Full 1600x1600	nr. 15 casse - crates - crates - crates - crates - crates 1600x1600
Full 1600x1600	nr. 9 cavalletti tipo 2 - stands type 2 - chevalets type 2 - Anzahl A-Böcke Typ 2 - caballetes tipo 2 - количество опор тип 2 1600x1600

CONTAINER 40 PIEDI - 40' Container - Conteneur 40' - 40' Container - Contenedor de 40 Pies - 40' Контейнер 11,90x2,32x2,35(h) m	
Full 1200x2400	nr. 12 cavalletti - stands - chevalets - Anzahl A-Böcke - caballetes - количество опор 1200x2400
Full 1200x2400	nr. 21 casse - crates - caisses - Anzahl Holzboxen - cajas - количество ящиков 1200x2400 + 4 cavalletti - stands - chevalets - Anzahl A-Böcke - caballetes - количество опор 1200x2400
Full 1200x2400	nr. 24 casse - crates - caisses - Anzahl Holzboxen - cajas - количество ящиков 1200x1200x9
Full 1200x1200	nr. 24 casse - crates - caisses - Anzahl Holzboxen - cajas - количество ящиков 1200x1200x20
Full 1200x2780	nr. 12 cavalletti - stands - chevalets - Anzahl A-Böcke - caballetes - количество опор 1200x2780
Full 1200x2780	nr. 21 casse - crates - caisses - Anzahl Holzboxen - cajas - количество ящиков 1200x2780 + 4 cavalletti - stands - chevalets - Anzahl A-Böcke - caballetes - количество опор 1200x2780
Full 1600x3200	nr. 15 casse - crates - caisses - Anzahl Holzboxen - cajas - количество ящиков 1600x3200
Full 1600x3200	nr. 9 cavalletti - stands - chevalets - Anzahl A-Böcke - caballetes - количество опор 1600x3200
Full 1600x1600	nr. 24 casse - crates - caisses - Anzahl Holzboxen - cajas - количество ящиков 1600x1600
Full 1600x1600	nr. 19 cavalletti tipo 2 - stands type 2 - chevalets type 2 - Anzahl A-Böcke Typ 2 - caballetes tipo 2 - количество опор тип 2 600x1600

CAMION, PESO MASSIMO CARICABILE - Truck, maximum loadable weight - Camion, poids maximum chargeable LKW maximal ladbares Gewicht - Camión, peso máximo cargable - Грузовик, максимальная загрузка		30 Ton.
Full 1200x2400	nr. 20 casse - crates - caisses - Anzahl Holzboxen - cajas - количество ящиков 1200x2400	
Full 1200x1200	nr. 24 casse - crates - caisses - Anzahl Holzboxen - cajas - количество ящиков 1200x1200	
Full 1200x2780	nr. 20 casse - crates - caisses - Anzahl Holzboxen - cajas - количество ящиков 1200x2780	
Full 1600x3200	nr. 15 casse - crates - caisses - Anzahl Holzboxen - cajas - количество ящиков 1600x3200	
Full 1600x3200	nr. 9 cavalletti - stands - chevalets - Anzahl A-Böcke - caballetes - количество опор 1600x3200	
Full 1600x1600	nr. 27 casse - crates - caisses - Anzahl Holzboxen - cajas - количество ящиков 1600x1600	
Full 1600x1600	nr. 19 cavalletti - stands - chevalets - Anzahl A-Böcke - caballetes - количество опор 1600x1600	

**LAYING SUGGESTIONS**

CLEANING AND MAINTENANCE

**PORCELAIN & WALL TILES**

**BEFORE STARTING THE INSTALLATION PROCESS, MAKE SURE THE LAYING SURFACE IS WELL CURED, FLAT AND COMPLETELY CLEAN.**

**1. CHOICE OF ADHESIVE**

The use of an appropriate adhesive is essential for a successful installation. For the installation of ceramic tiles, you should follow the laying instructions provided by leading adhesives manufacturers.

You should choose the most suitable adhesive on the basis of the following factors:

- laying surface
- type and size of tile
- use of tiled surface (floor/wall; indoor/outdoor)
- weather conditions at the time of laying
- waiting time before the ceramic surface can be used

USE	TYPE OF TILE	SIZE (cm)	RECOMMENDED ADHESIVES - European Standards EN 12004	
			Normal Set	Rapid set
<b>Laying surface</b>				
<b>INDOOR FLOORS</b>				
Cementitious screeds Existing cement floors (cement concrete, bush-hammered) Anhydrite screeds (following application of a suitable primer) Heating floors Existing ceramic, terrazzo and natural stone floors Waterproofing in bathrooms	porcelain stoneware tiles	< 30x30 cm	Improved cementitious adhesives with long open time (Class C2E).	Improved cementitious adhesives, slip resistant and deformable (Class C2FT - S1). ●
		≤ 30x30 cm < 60x60 cm	Improved cementitious adhesives resistant to slip and with long open time (Class C2TE).	Improved cementitious adhesives, slip resistant and deformable (Class C2FT - S1). ●
		≥ 60x60 cm	Improved cementitious adhesives with long open time and deformable (Class C2E - S1).	Improved cementitious adhesives, slip resistant and deformable (Class C2FT - S1). ●
<b>INDOOR WALL TILES</b>				
Cementitious plaster or mortar Plaster (plaster or panels, following application of a suitable primer) Painted walls Cast concrete (Following application of primer on gypsum-based joints) Plasterboard Waterproofing in bathrooms and showers Existing ceramic tiles	white body wall tiles          porcelain stoneware tiles	any size	Improved cementitious adhesives resistant to slip and with long open time (Class C2TE).	Improved cementitious adhesives, slip resistant and deformable (Class C2FT - S1). ●
		< 30x30 cm	Improved cementitious adhesives resistant to slip and with long open time (Class C2TE).	Improved cementitious adhesives, slip resistant and deformable (Class C2FT - S1). ●
		≤ 30x30 cm < 60x60 cm	Improved cementitious adhesives resistant to slip and with long open time (Class C2TE).	Improved cementitious adhesives, slip resistant and deformable (Class C2FT - S1). ●
≥ 60x60 cm	Improved cementitious adhesives resistant to slip with long open time and deformable (Class C2TE - S1).	Improved cementitious adhesives, slip resistant and deformable (Class C2FT - S1). ●		
<b>OUTDOOR FLOORS</b>				
Cementitious screeds Concrete floor Layers of waterproofing	porcelain stoneware tiles	< 30x30 cm	A Improved cementitious adhesives resistant to slip and with long open time (Class C2TE).	Improved cementitious adhesives, slip resistant and deformable (Class C2FT - S1). ●
		≤ 30x30 cm < 60x60 cm	Improved cementitious adhesives resistant to slip with long open time and deformable (Class C2TE - S1).	Improved cementitious adhesives, slip resistant and deformable (Class C2FT - S1). ●
		≥ 60x60 cm	Improved cementitious adhesives with long open time and highly deformable (Class C2E - S2).	Improved cementitious adhesives with long open time and highly deformable (Class C2FE - S2). ●
<b>OUTDOOR WALLS</b>				
Cementitious plaster Concrete cast in situ or prefabricated	porcelain stoneware tiles	< 30x30 cm	Improved cementitious adhesives resistant to slip with long open time and deformable (Class C2TE - S1).	Improved cementitious adhesives, slip resistant and deformable (Class C2FT - S1). ●
		≥ 30x30 cm < 60x60 cm ●●	Improved cementitious adhesives resistant to slip with long open time and deformable (Class C2TE - S1).	Improved cementitious adhesives, slip resistant and deformable (Class C2FT - S1). ●
		≥ 60x60 cm ●●	Improved cementitious adhesives with long open time and highly deformable (Class C2E - S2).	Improved and highly deformable cementitious adhesives (Class C2F - S2). ●

- For large size tiles laid at a height of more than three metres, certain international regulations specify that tiles should be laid using a mixed system of adhesive and mechanical fixtures chosen in relation to the weight of the tile, height of the tiling and site conditions.
- For tiles with a side measuring more than 30 cm laid at heights of more than three meters, certain international regulations specify the use of an additional mechanical anchor that ensures the retention of the tile in case of accidental detachment, to be chosen in relation to the weight of the tile, the height of the tiling and the site conditions.

**2. SPREADING THE ADHESIVES AND LAYING THE TILES: TIPS**

When laying tiles with a side longer than 60 cm and in any case for commercial indoor environments or outdoors it is essential to apply the adhesive using double buttering, applying the adhesive in a linear method parallel to the short side. It is essential that the direction of application of the adhesive on the substrate is parallel to the direction of application on the back of the tile, thus ensuring perfect adhesion between the tile and substrate.

In order to minimize the differences in level of the tiling system both on the floor and on the wall, it's best to use "easy-laying systems" with spacers and levelers that can be equipped with anti-chip and anti-scratch baseplates when laying white-body glazed wall tiles and/or porcelain tiles with a polished finish.

For wall tiles with three-dimensional surfaces we recommend the use of screw leveling systems as an alternative to wedge systems.

Apply the adhesive on the substrate using a trowel with appropriate toothing.

**3. SQUARE OR PERPENDICULAR CUTS**

It's best to first drill circular holes near the corners of the hole and then connect them with linear cuts, which will relax the tension at the corners of the tile.

**4. JOINTS AND GROUTING**

The invisible joints, i.e., installation with joints smaller than 2 mm, are not recommended.

For straight courses, the maximum offset between tiles must not exceed 1/3 of the length of the adjacent side.

You should follow the instructions provided by leading grout manufacturers.

USE	RECOMMENDED GROUTS - EUROPEAN STANDARDS EN 13888
Residential interiors	Improved cementitious mortars for joints (Class CG2)
Damp interiors (bathrooms, showers) and outdoors	Improved cementitious mortars for joints with low water absorption (CG2 WA)
Commercial premises	Improved cementitious mortars for joints with high resistance to abrasion (Class CG2 A)
Premises requiring total hygiene and resistance to chemical agents (swimming pools, kitchen work surfaces, food industry, hospitals, supermarkets, etc).	Epoxy mortars (Class RG).

**4a. ELIMINATION OF EXCESS GROUT**

To correctly and easily eliminate excess grout, follow the instructions given by the grout manufacturer. In general, proceed as follows:

**Cementitious grouts**

When the grout becomes opaque (normally after 10-20 minutes), clean with a hard cellulose sponge using movements on a diagonal to the joints. It is important to respect the drying time to avoid removing the grout from the joints.

**Epoxy grouts**

When the mixture is still fresh, wet the surface with plenty of water, emulsifying with a pad like Scotch-Brite®, paying attention not to empty the joints.

The residual grout liquid can be removed with a hard cellulose sponge (to be replaced when excessively soaked with resin).

It is vital to remove epoxy grout rapidly before it starts hardening as it is extremely difficult to remove subsequently. If the epoxy grout has started to harden, try adding 10% alcohol to the washing water.

**5. CLEANING AND MAINTENANCE**

**5a. FINAL SITE CLEANING**

After a few days, eliminate residues with a commercial Scotch-Brite® pad, brush or single brush floor cleaner (for large surfaces).

For walls, use a neutral detergent in hot water.

For floors, use a mild acid wash diluted according to the type of surface (smooth or textured). It is important to protect marble or metal inserts previously with adhesive tape.

Rinse with abundant clean water to eliminate all marks or residues from the joints.

If necessary, repeat the acid wash at a higher concentration, unless there are marble or metal inserts. Do not use diluted commercially-available acids.

**5b. ROUTINE MAINTENANCE**

You are recommended to use ordinary neutral detergent diluted in water.

Avoid using acid or alkaline products, waxes and/or impregnants and metal pads (iron or steel sponges).

In the event of heavy dirt or particularly textured surfaces, use an alkaline detergent and rinse after washing.

For large surfaces, the use of a floor washing machine is recommended.

**5c. EXTRAORDINARY MAINTENANCE**

In the event of dirt resistant to the ordinary cleaning, use a suitable detergent for the particular kind of dirt.

TYPE OF DIRT (resistant to ordinary maintenance)	DETERGENT/SOLVENT
Coal, lime efflorescence, chalk, metal marks, rust, graphite, emulsion paint	Acid detergents*
Coca cola, coffee, wine, beer, ice cream	Alkaline detergents
Resin, silicon or mechanical oils, candle wax, paint	Solvents
Tire marks, sole marks, suction cup marks	Alkaline detergent in an abrasive paste

\* Important: Acid products may corrode marble, granite, natural stone and metal. Avoid using in the presence of decoration or inserts in these materials

The suggestions and advice given above are the result of research, laboratory tests and many years experience.

However, the cleaning characteristics of the materials may vary significantly depending on the laying method, conditions of use, type of surface and environment. Generally speaking, the higher the non-slip characteristics of the tiles, the more difficult they are to clean.

The maintenance and cleaning operative should always test each cleaning method empirically in advance (if possible on a piece of the material not laid)

In the case of particularly heavy use (for example, mechanical workshops or environments with a heavy presence of oily residues and tire marks), incorrect laying or inappropriate cleaning, Atlas Concorde declines all responsibility for the effectiveness of cleaning and maintenance operations.

Atlas Concorde cannot, under no circumstances, be held responsible for events, damage or defects caused by incorrect laying, negligent cleaning and maintenance or the use of materials and adhesives inappropriate for the use.

For more information, refer to the "Installation, Use, Cleaning, and Maintenance Manual".





**SUGGERIMENTI PER LA POSA**

## SUGGERIMENTI DI PULIZIA E MANUTENZIONE

**PRIMA DI INIZIARE LA POSA, SI RACCOMANDA DI ASSICURARSI CHE LA SUPERFICIE DI APPOGGIO SIA SUFFICIENTEMENTE STAGIONATA, PLANARE E BEN PULITA.****1. SCELTA DELL'ADESIVO**

L'utilizzo di un adesivo appropriato è di fondamentale importanza per la posa. Si raccomanda di seguire le indicazioni dei migliori produttori di adesivi per la posa di piastrelle ceramiche.

In generale, l'adesivo più adeguato si individua considerando i seguenti fattori:

- tipo di supporto;
- tipologia e formato delle piastrelle;
- destinazione d'uso (pavimento/rivestimento; interno/esterno) del rivestimento ceramico;
- condizioni climatiche all'atto della posa;
- tempi a disposizione per la messa in esercizio del rivestimento ceramico.

DESTINAZIONE D'USO Tipo di supporto	TIPO DI PIASTRELLE Tipologia	FORMATO (cm)	ADESIVI CONSIGLIATI - Normativa Europea EN 12004	
			Pres a normale	Pres a rapida
<b>PAVIMENTI INTERNI</b>				
Massetti cementizi Pavimento in cemento esistenti (Battuto, bocciardato) Massetti in anidrite (Previa applicazione di opportuno primer) Massetti riscaldanti Pavimenti in ceramica, marmette e pietre naturali esistenti Impermeabilizzazione in bagni	grès porcellanato	< 30x30 cm	Adesivi cementizi migliorati e a tempo aperto allungato (classe C2E).	Adesivi cementizi migliorati resistenti allo scivolamento e deformabili (classe C2FT - S1). ●
		≤ 30x30 cm < 60x60 cm	Adesivi cementizi migliorati, resistenti allo scivolamento e a tempo aperto allungato (classe C2TE).	Adesivi cementizi migliorati resistenti allo scivolamento e deformabili (classe C2FT - S1). ●
		≥ 60x60 cm	Adesivi cementizi migliorati, a tempo aperto allungato e deformabili (classe C2E - S1).	Adesivi cementizi migliorati resistenti allo scivolamento e deformabile (classe C2FT - S1). ●
<b>RIVESTIMENTI INTERNI</b>				
Intonaco cementizio o malta Gesso (Intonaci o pannelli previa applicazonedi opportuno primer) Calcestruzzo di getto Gesso cartonato (Previa applicazione di primer sulle giunture a base gesso) Impermeabilizzazioni in bagni e docce Piastrelle ceramiche esistenti	rivestimenti in pasta bianca       grès porcellanato	tutti formati	Adesivi cementizi migliorati, resistenti allo scivolamento e a tempo aperto allungato (classe C2TE).	Adesivi cementizi migliorati resistenti allo scivolamento e deformabili (classe C2FT - S1). ●
		< 30x30 cm	Adesivi cementizi migliorati, resistenti allo scivolamento e a tempo aperto allungato (classe C2TE).	Adesivi cementizi migliorati resistenti allo scivolamento e deformabili (classe C2FT - S1). ●
		≤ 30x30 cm < 60x60 cm	Adesivi cementizi migliorati, resistenti allo scivolamento e a tempo aperto allungato (classe C2TE).	Adesivi cementizi migliorati resistenti allo scivolamento e deformabili (classe C2FT - S1). ●
		≥ 60x60 cm	Adesivi cementizi migliorati, resistenti allo scivolamento, a tempo aperto allungato e deformabili (classe C2TE - S1).	Adesivi cementizi migliorati resistenti allo scivolamento e deformabili (classe C2FT - S1). ●
<b>PAVIMENTI ESTERNI</b>				
Massetti cementizi Soletta in calcestruzzo Strati di impermeabilizzazione	grès porcellanato	< 30x30 cm	Adesivi cementizi migliorati, resistenti allo scivolamento e a tempo aperto allungato (classe C2TE).	Adesivi cementizi migliorati resistenti allo scivolamento e deformabili (classe C2FT - S1). ●
		≤ 30x30 cm < 60x60 cm	Adesivi cementizi migliorati, resistenti allo scivolamento, a tempo aperto allungato e deformabili (classe C2TE - S1).	Adesivi cementizi migliorati resistenti allo scivolamento e deformabili (classe C2FT - S1). ●
		≥ 60x60 cm	Adesivi cementizi migliorati, a tempo aperto allungato e altamente deformabili (classe C2E - S2).	Adesivi cementizi migliorati a tempo aperto allungato e altamente deformabile (classe C2FE - S2). ●
<b>RIVESTIMENTI ESTERNI</b>				
Intonaco cementizio Calcestruzzo gettato in opera o prefabbricato	grès porcellanato	< 30x30 cm	Adesivi cementizi migliorati, resistenti allo scivolamento, a tempo aperto allungato e deformabili (classe C2TE - S1).	Adesivi cementizi migliorati resistenti allo scivolamento e deformabili (classe C2FT - S1). ●
		≥ 30x30 cm < 60x60 cm ●●	Adesivi cementizi migliorati, resistenti allo scivolamento, a tempo aperto allungato e deformabili (classe C2TE - S1).	Adesivi cementizi migliorati resistenti allo scivolamento e deformabili (classe C2FT - S1). ●
		≥ 60x60 cm ●●	Adesivi cementizi migliorati, a tempo aperto allungato e altamente deformabili (classe C2E - S2).	Adesivi cementizi migliorati e altamente deformabili (classe C2F - S2). ●

● Nel caso di posa in condizioni di basse temperature oppure qualora sia necessario mettere in esercizio rapidamente il rivestimento ceramico è preferibile l'utilizzo di adesivi cementizi migliorati a presa rapida (Classe C2F - EN 12004).

●● Nel caso di piastrelle con un lato maggiore di 30 cm posate ad altezze superiori ai 3 metri, alcune normative internazionali prevedono l'utilizzo di un ancoraggio meccanico supplementare che assicuri la ritenzione della piastrella in caso accidentale di distacco, da scegliere in relazione al peso della piastrella, all'altezza del rivestimento ed alle condizioni del cantiere.

**2. STESURA DEGLI ADESIVI E POSA DELLE PIASTRELLE:**

Nel caso di posa di piastrelle con un lato di lunghezza maggiore di 60 cm e in ogni caso per ambienti interni commerciali oppure all'esterno è fondamentale applicare

l'adesivo con il sistema della doppia spalmatura applicando la colla linearmente in direzione parallela al lato corto. E' fondamentale che sia parallela la direzione di applicazione dell'adesivo sul supporto di posa a quella applicata sul retro della piastrella, garantendo così la perfetta aderenza all'interfaccia piastrella ceramica-supporto.

Per minimizzare i dislivelli del sistema piastrellatura sia a pavimento che a rivestimento si raccomanda l'adozione di "sistemi di posa facilitata" con distanziatori e livellatori che possono essere provvisti di pedane anti-sbeccature e anti-graffio nel caso in cui si posino rivestimenti smaltati in pasta bianca e/o gres con finitura lappate.

Nel caso particolare di rivestimenti con strutture tridimensionali si consiglia l'utilizzo dei sistemi di livellamento a vite, alternativi a quelli a cuneo.

Applicare l'adesivo sul supporto mediante spatola di idonea dentatura.

**GRES PORCELLANATO & RIVESTIMENTI****3. ESECUZIONI TAGLI QUADRATI O SQUADRI**

Si consiglia di eseguire inizialmente fori circolari in prossimità dei vertici del taglio e collegarli in un secondo momento attraverso tagli lineari, in questo modo si avrà un rilassamento delle tensioni sui vertici della piastrella tagliata.

**4. FUGA E STUCCATURA**

Si consiglia la posa a giunto unito ovvero posa con fughe inferiori ai 2 mm.

Nel caso di posa "a correre" il massimo sfalsamento tra piastrelle non deve superare 1/3 della lunghezza del lato adiacente.

Si raccomanda di seguire le indicazioni dei migliori produttori di stucchi per fughe.

DESTINAZIONE D'USO	STUCCHI CONSIGLIATI - Normativa Europea EN 13888
Ambienti interni residenziali	Malte cementizie per fughe migliorate (Classe CG2)
Ambienti umidi interni (bagni, docce) ed ambienti esterni	Malte cementizie per fughe migliorate con assorbimento di acqua ridotto (classe CG2 WA)
Ambienti ad uso commerciale	Malte cementizie per fughe migliorate con elevata resistenza all'abrasione (classe CG2 A)
Ambienti in cui sia richiesta totale igiene e resistenza agli agenti chimici (piscine, piani di lavoro di cucine, industrie alimentari, ospedali, supermercati, ecc.)	Malte epossidiche (classe RG).

**4a. ELIMINAZIONE DELLO STUCCO IN ECCESSO**

Per una corretta ed agevole eliminazione degli eccessi di stucco, si raccomanda di seguire le indicazioni del produttore dello stucco. In generale, si consiglia di attenersi a quanto segue.

**Stucchi cementizi**

Quando lo stucco diventa opaco (normalmente dopo 10-20 minuti), pulire con una spugna di cellulosa dura con movimenti diagonali rispetto alle fughe. E' importante il rispetto di questi tempi per non rischiare di rimuovere lo stucco dalle fughe.

**Stucchi epossidici**

A impasto ancora fresco, bagnare abbondantemente la superficie emulsionando con un tampone tipo Scotch-Brite®, facendo attenzione a non svuotare le fughe. Il residuo liquido di stucco può essere rimosso con una spugna di cellulosa dura (da sostituire se troppo impregnata di resina). E' fondamentale rimuovere lo stucco epossidico tempestivamente prima che inizi ad indurirsi, in quanto la successiva rimozione risulterebbe estremamente difficile. Nel caso in cui lo stucco epossidico abbia già iniziato a indurirsi, provare ad aggiungere all'acqua di lavaggio il 10% di alcool.

**5.PULIZIA E MANUTENZIONE****5a. PULIZIA DI FINE CANTIERE**

Dopo alcuni giorni, eliminare i residui di cantiere con spugna commerciale tipo Scotch-Brite® oppure con spazzolone o monospazzola (per grandi superfici).

Per i rivestimenti, utilizzare un detergente neutro diluito in acqua calda.

Per i pavimenti, utilizzare un detergente acido ad azione tamponata, in percentuale di diluizione variabile in funzione del tipo di superficie (liscia oppure strutturata).

E' importante proteggere preventivamente eventuali inserti in marmo o metallo con nastro adesivo.

Risciacquare poi abbondantemente con acqua calda pulita, sino alla eliminazione di qualsiasi alonatura o residuo negli interstizi.

Se necessario, ripetere il lavaggio acido a concentrazioni più elevate ad eccezione del caso in cui siano presenti inserti in marmo o metallo. Evitare l'utilizzo di acidi da ferramenta diluiti.

**5b. MANUTENZIONE ORDINARIA**

Si consiglia l'utilizzo di un comune detergente neutro diluito in acqua.

Evitare l'utilizzo di prodotti acidi, alcalini, ceranti e/o impregnanti e pagliette di metallo (spugnette di ferro e acciaio).

In caso di sporchi più intensi o di superfici particolarmente strutturate, usare un detergente a base alcalina risciacquando al termine del lavaggio.

Per le grandi superfici è consigliabile l'utilizzo di macchine lavasciuga.

**5c. MANUTENZIONE STRAORDINARIA**

Nel caso di tracce di sporco resistenti alla pulizia ordinaria, si raccomanda l'utilizzo di un detergente adeguato in funzione del tipo di sporco.

TIPO DI SPORCO (resistente alla manutenzione ordinaria)	DETERGENTE/SOLVENTE
Carbone, efflorescenze calcaree, gesso, segni metallici, ruggine, grafite, tempere murali	Detergenti a base acida *
Coca cola, caffè, vino, birra, gelato	Detergenti a base alcalina
Resine, oli siliconici o meccanici, cere di candela, vernice	Solventi
Pneumatici, suole di gomma, alonature di ventose	Detergenti basici in pasta abrasiva

\* Attenzione: i prodotti a base acida possono corrodere marmo, granito, pietre naturali e metalli, pertanto evitarne l'uso nel caso di decori o inserti realizzati con questi materiali.

Le caratteristiche di pulibilità dei materiali variano in modo significativo per le diverse modalità d'installazione, condizioni d'uso, tipologie di superfici e ambiente. In linea generale, all'aumentare delle caratteristiche di anticivolosità delle piastrelle aumentano le difficoltà di pulizia.

L'operatore professionale incaricato dell'intervento di manutenzione e pulizia dovrà sempre procedere ad una preliminare verifica empirica (possibilmente su una porzione di materiale non posato) per ogni singolo tipo di intervento.

In caso di condizioni d'uso particolarmente gravose (ad esempio, officine meccaniche o ambienti con forte presenza di residui oleosi e tracce di pneumatico), di errata installazione o di pulizie effettuate in modo inadeguato, Atlas Concorde declina ogni responsabilità in merito all'efficacia delle operazioni di pulizia e manutenzione.

Resta inteso che Atlas Concorde non potrà essere ritenuta responsabile per eventi, danni o difetti dovuti ad errata installazione, negligente pulizia e manutenzione, o inadeguata scelta della tipologia dei materiali installati e degli adesivi utilizzati con riguardo alla destinazione.

Per maggiori informazioni si rimanda al "Manuale di Posa, Uso, Pulizia e Manutenzione".

INDEX

PRODUCT  
FINDERSURFACE  
RANGE

COMPANY



COLLECTIONS



LARGE SIZES

TECHNICAL  
SPECIFICATIONS

## CONSEILS POUR LA POSE NETTOYAGE ET ENTRETIEN

### AVANT TOUTE POSE, IL EST RECOMMANDÉ DE S'ASSURER QUE LE SUPPORT EST SUFFISAMMENT SEC, PLAN ET PROPRE.

#### 1. CHOIX DE LA COLLE

Pour une pose de qualité, il est fondamental d'utiliser une colle appropriée. Toujours respecter les indications fournies par les meilleurs producteurs de colle pour la pose de carreaux céramiques.

Les facteurs ci-après permettent généralement d'identifier l'adhésif le plus approprié :

- type de support ;
- type et format du carrelage ;
- type d'application du revêtement céramique (sol/mur ; intérieur/extérieur) ;
- conditions climatiques au moment de la pose ;
- temps disponible pour la mise en service du revêtement céramique.

TYPE D'APPLICATION Type de support	TYPE DE CARRELAGE Typologie	FORMAT: (cm)	ADHÉSIFS RECOMMANDÉS Normes Européennes En 12004			
			Séchage normal:	Séchage rapide		
REVÊTEMENTS DE SOL INTÉRIEURS						
Chapes à base de ciment Revêtements de sol en ciment déjà existants (darnés, bouchardés) Chapes anhydrite (Après application d'un primaire approprié) Chapes chauffantes Revêtements de sol déjà existants (Céramique, carreaux de marbre et pierres naturelles) Imperméabilisation salles de bains	carreaux en grès cérame	< 30x30 cm	Mortiers-colles améliorés, à temps ouvert allongé (classe C2E).	Mortiers-colles améliorés résistant au glissement et déformables (classe C2FT - S1). ●		
		≤ 30x30 cm < 60x60 cm	Mortiers-colles améliorés résistant au glissement, à temps ouvert allongé (classe C2TE).	Mortiers-colles améliorés résistant au glissement et déformables (classe C2FT - S1). ●		
		≥ 60x60 cm	Mortiers-colles améliorés, à temps ouvert allongé et déformables (classe C2E - S1).	Mortiers-colles améliorés résistant au glissement et déformables (classe C2FT - S1). ●		
REVÊTEMENTS DE MUR INTÉRIEURS						
Enduit à base de ciment ou mortier Plâtre (enduits ou panneaux, après application d'un primaire approprié) Béton coulé Plâtre cartonné (Après avoir appliqué de l'armorçant sur les joints base plâtre) Imperméabilisation salles de bains et douches Carrelages céramiques déjà existants	carreaux à pâte blanche	tous formats	Mortiers-colles améliorés résistant au glissement, à temps ouvert allongé (classe C2TE).	Mortiers-colles améliorés résistant au glissement et déformables (classe C2FT - S1). ●		
		< 30x30 cm	Mortiers-colles améliorés résistant au glissement, à temps ouvert allongé (classe C2TE).	Mortiers-colles améliorés résistant au glissement et déformables (classe C2FT - S1). ●		
		≤ 30x30 cm < 60x60 cm	Mortiers-colles améliorés résistant au glissement, à temps ouvert allongé (classe C2TE).	Mortiers-colles améliorés résistant au glissement et déformables (classe C2FT - S1). ●		
Chapes à base de ciment Dallage en béton Couches d'imperméabilisation	carreaux en grès cérame	≥ 60x60 cm	Mortiers-colles améliorés résistant au glissement, à temps ouvert allongé et déformables (classe C2TE - S1).	Mortiers-colles améliorés résistant au glissement et déformables (classe C2FT - S1). ●		
		REVÊTEMENTS DE SOL EXTÉRIEURS				
		< 30x30 cm	Mortiers-colles améliorés résistant au glissement, à temps ouvert allongé (classe C2TE).	Mortiers-colles améliorés résistant au glissement et déformables (classe C2FT - S1). ●		
Chapes à base de ciment Dallage en béton Couches d'imperméabilisation	carreaux en grès cérame	≤ 30x30 cm < 60x60 cm	Mortiers-colles améliorés résistant au glissement, à temps ouvert allongé et déformables (classe C2TE - S1).	Mortiers-colles améliorés résistant au glissement et déformables (classe C2FT - S1). ●		
		≥ 60x60 cm	Mortiers-colles améliorés, à temps ouvert allongé et hautement déformables (classe C2E - S2).	Mortiers-colles améliorés, à temps ouvert allongé et hautement déformables (classe C2E - S2). ●		
		REVÊTEMENTS DE MUR EXTÉRIEURS				
Enduit à base de ciment Béton coulé sur place ou préfabriqué	carreaux en grès cérame	< 30x30 cm	Mortiers-colles améliorés résistant au glissement, à temps ouvert allongé et déformables (classe C2TE - S1).	Mortiers-colles améliorés résistant au glissement et déformables (classe C2FT - S1). ●		
		≥ 30x30 cm < 60x60 cm ●●	Mortiers-colles améliorés résistant au glissement, à temps ouvert allongé et déformables (classe C2TE - S1).	Mortiers-colles améliorés résistant au glissement et déformables (classe C2FT - S1). ●		
		≥ 60x60 cm ●●	Mortiers-colles améliorés, à temps ouvert allongé et hautement déformables (classe C2E - S2).	Mortiers-colles améliorés et hautement déformables (classe C2F - S2). ●		

● En cas de pose à basse température ou bien de mise en service rapide du revêtement céramique, il est préférable d'utiliser des mortiers-colles améliorés à prise rapide (Classe C2F - EN 12004).

●● En cas de carreaux de côté dépassant 30 cm appliqués à des hauteurs de plus de 3 mètres, certaines normes internationales exigent l'utilisation d'un ancrage mécanique supplémentaire, pour assurer la rétention du carreau en cas de décollage accidentel. Ceux-ci doivent être choisis en fonction du poids du carreau, de la hauteur du revêtement et des conditions sur le chantier.

#### 2. APPLICATION DES COLLES ET POSE DU CARRELAGE

En cas de pose de carreaux ayant un côté de longueur supérieure à 60 cm, ainsi qu'en cas de pose à l'intérieur d'espaces commerciaux ou de pose en extérieur, il est fondamental d'appliquer la colle avec le système du double encollage en appliquant la colle de manière linéaire et parallèle au côté court. Il est fondamental que le sens d'application de la colle sur le support de la pose soit parallèle à celui appliqué au dos du carreau, en garantissant ainsi une adhérence parfaite entre le carreau et le support. Pour réduire tout éventuel décalage du carrelage sur le sol et sur le mur, il est recommandé d'adopter des "systèmes de pose facilitée" en utilisant des croisillons et des niveleurs qui peuvent être munis de supports anti-ébréchures et anti-rayures en cas de pose de carreaux en pâte blanche émaillés et/ou de carreaux en grès en finition semi-polie.

Dans le cas particulier de carrelages à structure tridimensionnelle, nous conseillons l'utilisation de systèmes de nivellement à vis, en alternative aux systèmes à coin.

Appliquer l'adhésif sur le support avec une spatule à dents adéquates.

## GRÈS CÉRAME & REVÊTEMENTS

#### 3. EXÉCUTION DE DÉCOUPES À ANGLE DROIT OU À BISEAU

Il est conseillé de commencer par effectuer des trous circulaires en proximité des bords de la découpe, puis, dans un deuxième temps, de les relier par des découpes linéaires, ce qui permettra d'obtenir une relaxation des contraintes au niveau des bords du carreau découpé.

#### 4. JOINT ET MASTICAGE

Il est déconseillé d'effectuer des poses à bords unis, à savoir dont les joints sont inférieurs à 2 mm.

En cas de pose "en succession", le décalage maximum entre les carreaux ne doit pas dépasser 1/3 de la longueur du côté adjacent.

Il est recommandé de respecter les indications fournies par les meilleurs producteurs de mortiers pour joints.

TYPE D'APPLICATION	MORTIERS RECOMMANDÉS - Norme Européenne En 13888
Espaces résidentiels intérieurs	Mortiers à base de ciment pour joints améliorés (Classe CG2)
Espaces humides intérieurs (salles de bains, douches) et espaces extérieurs	Mortiers à base de ciment pour joints améliorés à faible absorption d'eau (Classe CG2 WA)
Espaces à usage commercial	Mortiers à base de ciment pour joints améliorés, hautement résistants à l'abrasion (Classe CG2 A)
Espaces nécessitant une hygiène totale et une résistance aux agents chimiques (piscines, plans de travail de cuisines, industries alimentaires, hôpitaux, supermarchés, etc.)	Mortiers époxy (Classe RG).

### 4a. ÉLIMINATION DU MORTIER EXCÉDENTAIRE

Toujours respecter les indications du fabricant de mortier pour pouvoir éliminer correctement et facilement le produit excédentaire. Il est généralement recommandé de procéder de la façon suivante:

**Mortiers à base de ciment**

Dès que le mortier devient opaque (généralement au bout de 10-20 minutes), nettoyer à l'aide d'une éponge en cellulose dure en faisant des mouvements diagonaux par rapport aux joints. Il est important de respecter le temps indiqué pour ne pas risquer de retirer le mortier des joints.

**Mortiers époxy**

Lorsque le mélange est encore frais, mouiller abondamment la surface et émulsionner avec un tampon de type Scotch-Brite® en veillant bien à ne pas vider les joints.

Le résidu liquide de mortier peut s'enlever à l'aide d'une éponge en cellulose dure (à remplacer si elle est trop imprégnée de résine).

Il est fondamental d'éliminer le mortier époxy à temps, avant qu'il ne commence à durcir, après quoi l'opération s'avère extrêmement difficile. Si le mortier a déjà commencé à prendre, essayer d'ajouter 10% d'alcool à l'eau de lavage.

### 5.NETTOYAGE ET ENTRETIEN

#### 5a. NETTOYAGE EN FIN DE CHANTIER

Au bout de plusieurs jours, nettoyer les résidus de chantier à l'aide d'une éponge commerciale Scotch-Brite® d'un balai-brosse ou d'un balai d'atelier (pour grandes surfa-ces).Pour les revêtements de mur, utiliser un produit détergent neutre, dilué dans de l'eau chaude.

Pour les revêtements de sol, utiliser un produit détergent acide à effet tampon en variant le pourcentage de dilution selon le type de surface (lisse ou structurée). Il est i important de protéger préalablement tout insert en marbre ou en métal avec du ruban adhésif.

Rincer ensuite abondamment avec de l'eau chaude propre jusqu'à ce qu'il n'y ait plus d'auréoles ni de résidus dans les interstices.

Répéter si nécessaire le lavage acide à des concentrations plus élevées (s'abstenir s'il y a des inserts en marbre ou en métal). Éviter toute utilisation d'acides commerciaux dilués.

#### 5b. ENTRETIEN ORDINAIRE

Il est recommandé d'utiliser un produit détergent ordinaire, neutre et dilué dans de l'eau.

Éviter toute utilisation d'acides, alcalins, produits de cirage et/ou imprégnants, pailles de fer et éponges métalliques en fer et en acier.

En cas de saleté plus consistante ou de surfaces particulièrement structurées, utiliser un produit détergent à base alcaline et rincer en fin de lavage.

Pour les grandes surfaces, il est recommandé d'utiliser des machines laveuses et sécheuses.

#### 5c. ENTRETIEN EXTRAORDINAIRE

En cas de saleté résistant au nettoyage ordinaire, il est recommandé d'utiliser un produit détergent adapté au type de saleté.

TYPE DE SALETÉ (résistant à l'entretien ordinaire)	DÉTERGENT/SOLVANT
Charbon, efflorescences calcaires, plâtre, signes métalliques, rouille, graphite, peintures murales à la détrempe	Détergents à base acide *
Coca-cola, café, vin, bière, glace	Détergents à base alcaline
Résines, huiles silicones ou mécaniques, cire de bougie, peinture	Solvants
Pneus, semelles en caoutchouc, auréoles provoquées par des ventouses	Détergents basiques en pâte abrasive

\* Attention : les produits à base d'acide peuvent ronger le marbre, le granit, les pierres naturelles et les métaux, par conséquent ne pas les utiliser en présence de décors ou d'inserts réalisés avec ces types de matériaux.

Toutefois, les caractéristiques de nettoyabilité des matériaux peuvent varier de façon significative selon les modalités de pose, les conditions d'utilisation, les types de surfaces et de lieux. Généralement, plus les caractéristiques antidérapantes des carreaux sont élevées, plus le nettoyage est difficile.

Avant chaque intervention, l'opérateur professionnel chargé de l'entretien et du nettoyage devra toujours effectuer un contrôle empirique (si possible sur une portion de matériau non posée).

Atlas Concorde décline toute responsabilité quant à l'efficacité des opérations de nettoyage et d'entretien en cas de poses ou de nettoyages défectueux ainsi que dans des conditions d'utilisation particulièrement difficiles (par exemple, dans des ateliers de mécaniciens ou dans des endroits avec des résidus huileux importants et des traces de pneu).

Il est entendu qu'Atlas Concorde ne saurait être tenue pour responsable d'événements, de dommages ou de vices dus à une pose défectueuse, un nettoyage et un entretien négligés ou un mauvais choix du matériau ou des adhésifs pour l'usage considéré.

Pour plus d'informations, consulter le "Manuel de pose, d'emploi, d'entretien et de nettoyage".

## INDEX



## PRODUCT FINDER



## SURFACE RANGE



## COMPANY



## COLLECTIONS



## LARGE SIZES



## TECHNICAL SPECIFICATIONS



**VERLEGETIPPS**

## REINIGUNG UND PFLEGE

**VOR BEGINN DER VERLEGUNG SICHERSTELLEN, DASS DER UNTERGRUND AUSREICHEND VERLEGEREIF, EBEN UND EINWANDFREI SAUBER IST.****1. WAHL DES KLEBERS**

Der Gebrauch eines geeigneten Klebers ist für die Verlegung von grundlegender Bedeutung. Befolgen Sie die Angaben der führenden Kleberhersteller für die Verlegung von Keramikfliesen.

In der Regel kann der geeignetste Kleber aufgrund der folgenden Faktoren bestimmt werden:

- Art des Untergrunds;
- Fliesentyp und Fliesenformat;
- Gebrauchsbestimmung der Fliesen (Boden-/Wandbelag; Innen-/Außenbereich);
- klimatische Bedingungen bei der Verlegung;
- verfügbare Zeiten für die Inbetriebnahme des Belags.

GEBRAUCHSBESTIMMUNG Art des Untergrunds	FLIESENTYP Typ	FORMAT (cm)	EMPFOHLENE KLEBER - Europäische NormenEN 12004	
			Normal Abbindend	Schnell Abbindend
<b>BÖDEN IM INNENBEREICH</b>				
Zementestriche Bestehende Bodenbeläge (gebundene, verdichtete Betonuntergründe) Anhydritestriche (nach entsprechender Behandlung mit Primer) Heizestriche Bestehende Bodenbeläge aus Keramik, Terrazzo, Naturstein Abdichtung in Nassräumen	Feinsteinzeugfliesen	< 30x30 cm	Vergütete Zementkleber mit verlängerter kleböffener Zeit (Klasse C2E).	Vergütete, standfeste und flexible Zementkleber (Klasse C2FT - S1). ●
		≤ 30x30 cm < 60x60 cm	Vergütete, standfeste, flexible Zementkleber mit verlängerter kleböffener Zeit gemäß und Verformbarkeit gemäß (Klasse C2TE).	Vergütete, standfeste und flexible Zementkleber (Klasse C2FT - S1). ●
		≥ 60x60 cm	Vergütete, flexible Zementkleber mit verlängerter kleböffener Zeit gemäß und Verformbarkeit gemäß (Klasse C2E - S1).	Vergütete, standfeste und flexible Zementkleber (Klasse C2FT - S1). ●
<b>WANDBELÄGE IM INNENBEREICH</b>				
Zementputz oder Mörtel Gips (Putze oder Platten, nach entsprechender Behandlung mit Primer) Ortbeton Gipskarton (Auf gipshaltige Fugen vorher Primer auftragen) Abdichtung in Bädern und Duschen Bestehende Keramikfliesen	Weißscherbige Fliesen	Alle Formate	Vergütete, standfeste, flexible Zementkleber mit verlängerter kleböffener Zeit gemäß und Verformbarkeit gemäß (Klasse C2TE).	Vergütete, standfeste und flexible Zementkleber (Klasse C2FT - S1). ●
		< 30x30 cm	Vergütete, standfeste, flexible Zementkleber mit verlängerter kleböffener Zeit gemäß und Verformbarkeit gemäß (Klasse C2TE).	Vergütete, standfeste und flexible Zementkleber (Klasse C2FT - S1). ●
	Feinsteinzeugfliesen	≤ 30x30 cm < 60x60 cm	Vergütete, standfeste, flexible Zementkleber mit verlängerter kleböffener Zeit gemäß und Verformbarkeit gemäß (Klasse C2TE).	Vergütete, standfeste und flexible Zementkleber (Klasse C2FT - S1). ●
≥ 60x60 cm		Vergütete, standfeste, flexible Zementkleber mit verlängerter kleböffener Zeit gemäß und Verformbarkeit gemäß (Klasse C2TE - S1).	Vergütete, standfeste und flexible Zementkleber (Klasse C2FT - S1). ●	
<b>BÖDEN IM AUSSENBEREICH</b>				
Zementestriche Betonuntergrund Abdichtschichten	Feinsteinzeugfliesen	< 30x30 cm	Vergütete, standfeste Zementkleber mit verlängerter kleböffener Zeit (Klasse C2TE).	Vergütete, standfeste und flexible Zementkleber (Klasse C2FT - S1). ●
		≤ 30x30 cm < 60x60 cm	Vergütete, standfeste, flexible Zementkleber mit verlängerter kleböffener Zeit gemäß und Verformbarkeit gemäß (Klasse C2TE - S1).	Vergütete, standfeste und flexible Zementkleber (Klasse C2FT - S1). ●
		≥ 60x60 cm	Vergütete, hochflexible Zementkleber mit verlängerter kleböffener Zeit gemäß und Verformbarkeit gemäß (Klasse C2E - S2).	Vergütete, hochflexible Zementkleber mit verlängerter kleböffener Zeit gemäß und Verformbarkeit gemäß (Klasse C2FE - S2). ●
<b>AUSSENWANDBELÄGE</b>				
Zementputz Ortbeton und Fertigbeton	Feinsteinzeugfliesen	< 30x30 cm	Vergütete, standfeste, flexible Zementkleber mit verlängerter kleböffener Zeit gemäß und Verformbarkeit gemäß (Klasse C2TE - S1).	Vergütete, standfeste und flexible Zementkleber (Klasse C2FT - S1). ●
		≥ 30x30 cm < 60x60 cm ●●	Vergütete, standfeste, flexible Zementkleber mit verlängerter kleböffener Zeit gemäß und Verformbarkeit gemäß (Klasse C2TE - S1).	Vergütete, standfeste und flexible Zementkleber (Klasse C2FT - S1). ●
		≥ 60x60 cm ●●	Vergütete, hochflexible Zementkleber mit verlängerter kleböffener Zeit gemäß und Verformbarkeit gemäß (Klasse C2E - S2).	Vergütete und hochflexible Zementkleber (Klasse C2F - S2). ●

- Bei der Verlegung bei niedrigen Temperaturen oder falls eine rasche Inbetriebnahme des Belags erforderlich ist, wird der Gebrauch von schnell abbindenden zementären Klebemörteln mit verbesserter Haftung (Klasse C2F – EN 12004) empfohlen.
- Für Fliesen mit langer Seite über 30 cm, die in einer Höhe von über 3 Metern verlegt werden, schreiben einige internationale Vorschriften eine zusätzliche mechanische Verankerung vor, die die Fliese bei unbeabsichtigter Ablösung zurückhält und je nach Fliesengewicht, Belagshöhe und Baustellenbedingungen gewählt werden müssen.

**2. AUFTRAG DER KLEBER UND VERLEGUNG DER FLIESEN**

Bei Fliesen mit einer langen Seite von mehr als 60 cm und in jedem Fall in gewerblich genutzten Innenräumen sowie bei der Verlegung im Freien ist der Kleber unbedingt mit dem Buttering-Floating-Verfahren aufzutragen, wobei er linear parallel zur kurzen Seite aufzuziehen ist. Es ist unerlässlich, dass die Auftragsrichtung des Klebers auf dem Untergrund und jene auf der Fliesenrückseite parallel zueinander sind, da dies ein perfektes Anhaften der Verbindung zwischen Keramikfliese und Untergrund gewährleistet.

Zur Reduzierung von Unebenheiten im Fliesenbelag an Wand und Boden empfiehlt es sich, Verlegehilfen wie Distanzstücke und Nivellierelemente zu verwenden. Bei Verlegung von glasierten Wandfliesen aus Weißscherben und/oder Feinsteinzeug mit geläppter Oberfläche sollten Keile zusammen mit Schutzplatten zum Schutz gegen Abspalten der Kanten und Verkratzung genutzt werden.

Bei besonderen Wandbelägen mit dreidimensionaler Struktur empfiehlt es sich, zur Nivellierung anstelle von Keilen Schraubsysteme zu verwenden.

Den Kleber mit Hilfe eines Spachtels mit geeigneter Zahnung auf den Untergrund auftragen.

**FEINSTEINZEUG & WANDFLIESEN****3. AUSFÜHRUNG QUADRATISCHER BZW. LOTRECHTER SCHNITTE**

Es empfiehlt sich, zunächst an den Eckpunkten des Schnitts kreisförmige Bohrungen auszuführen und diese anschließend durch lineare Schnitte zu verbinden. Auf diese Weise werden die Spannungen an den Ecken der geschnittenen Fliese abgebaut.

**4. EMPFOHLENE FUGENMASSEN**

Von der fugenlosen Verlegung bzw. von einer Fugenbreite unter 2 mm wird abgeraten.

Bei fortlaufender Längsverlegung dürfen die Fliesen nicht um mehr als 1/3 der Länge der jeweils angrenzenden Seiten versetzt werden.

Befolgen Sie die Angaben der führenden Fugenmassenhersteller.

GEBRAUCHSBESTIMMUNG	EMPFOHLENE FUGENMASSEN - EUROPÄISCHE NORM EN 13888
Innenbereich in privaten Objekten	Vergütete Fugenmörtel (Klasse CG2)
Nassräume im Innenbereich (Badezimmer, Duschen) und im Außenbereich	Zementäre Fugenmörtel mit verbesserten Eigenschaften und reduzierter Wasseraufnahme (Klasse CG2 WA)
Innenbereich in gewerblichen Objekten	Zementäre Fugenmörtel mit verbesserten Eigenschaften und hoher Abriebfestigkeit (Klasse CG2 A)
Bereiche, in denen es auf absolute Hygiene und Chemikalienbeständigkeit ankommt (Schwimmb Becken, Arbeitsplatten in Küchen, Lebensmittelindustrie, Krankenhäuser, Supermärkte etc.)	Epoxidharzfugenmörtel (Klasse RG).

**4a. ENTFERNEN DER ÜBERSCHÜSSIGEN FUGENMASSE**

Für die korrekte und problemlose Entfernung von überschüssiger Fugenmasse die Angaben des Herstellers befolgen. Generell wird empfohlen, folgende Anweisungen zu beachten.

**Zementäre Fugenmörtel**

Wenn die Fugenmasse nicht mehr glänzt (normalerweise nach 10-20 Minuten), mit einem harten Zelluloseschwamm diagonal zum Fugenverlauf reinigen. Diese Zeiten müssen beachtet werden, um ein Entfernen der Fugenmasse aus den Fugen zu vermeiden.

**Epoxidharz-Fugenmörtel**

Bei noch frischer Masse die Oberfläche mit viel Wasser annässen und mit einem Pad vom Typ Scotch-Brite® bearbeiten; darauf achten, dass die Fugen nicht ausgewaschen werden.

Die flüssigen Fugenmassenreste mit einem harten Zelluloseschwamm (zu ersetzen, falls zu sehr mit Harz imprägniert) entfernen.

Wichtig ist es, dass die Epoxidharz-Fugenmasse rechtzeitig entfernt wird, bevor sie auszuhärten beginnt, da sie danach nur sehr schwer beseitigt werden kann. Falls die Epoxidharz-Fugenmasse bereits begonnen hat auszuhärten, kann man versuchen, dem Waschwasser 10 % Alkohol beizumengen.

**5. REINIGUNG UND PFLEGE****5a. BAUSCHLUSSREINIGUNG**

Nach einigen Tagen die Rückstände mit Scotch-Pad® oder mit einer Bürste bzw. einer Einscheiben-Bodenreinigungsmaschine (bei großen Flächen) entfernen.

Für die Wandbeläge einen mit warmem Wasser verdünnten neutralen Reiniger verwenden.

Für die Bodenbeläge ein saures Reinigungsmittel mit Pufferwirkung verwenden, das je nach Oberfläche (glatt oder strukturiert) zu verdünnen ist. Wichtig ist es, dass eventuelle Marmor- oder Metalleinleger vorsorglich mit Klebeband geschützt werden.

Danach mit reichlich warmem und sauberem Wasser nachspülen, bis Schleier und Schmutz restlos entfernt sind.

Gegebenenfalls die Reinigung mit einer stärker konzentrierten Säurelösung wiederholen; bei Marmor- oder Metalleinlegern ist dies jedoch zu vermeiden. Keine verdünnten Säuren für Eisenwaren verwenden.

**5b. NORMALE PFLEGE**

Für die Pflege wird ein gewöhnlicher, mit Wasser verdünnter neutraler Reiniger empfohlen.

Saure oder alkalische Produkte, Wachs- und/oder Imprägniermittel sowie Stahlwollepads (Eisen- und Stahlschwämme) sind zu vermeiden.

Bei hartnäckiger Verschmutzung oder besonders strukturierten Oberflächen einen alkalischen Reiniger verwenden und nach dem Reinigen nachspülen.

Bei großen Flächen empfiehlt sich die Verwendung einer Bodenreinigungsmaschine.

**5c. SONDERREINIGUNG**

Bei durch normale Pflege nicht zu beseitigender Verschmutzung wird der Gebrauch eines für die jeweilige Schmutzart geeigneten Reinigers empfohlen.

SCHMUTZART (hartnäckig gegen normale Pflegeprodukte)	REINIGER/LÖSEMittel
Kohle, Kalkausblühungen, Gips, Metallabrieb, Rost, Graphit, Wandanstriche	Saure Reiniger*
Coca-Cola, Kaffee, Wein, Bier, Speiseeis	Alkalische Reiniger
Kunsthartz, Silikon und mechanisches Öl, Kerzenwachs, Lack	Lösemittel
Gummiabrieb (Reifen, Schuhsohlen, Abdrücke von Saugnäpfen)	Basische Reiniger (Scheuerpaste)

\* Achtung: Produkte auf Säurebasis können Marmor, Granit, Naturstein und Metalle angreifen. Bei Einlegern oder Dekorfliesen aus diesen Materialien sind sie deshalb zu vermeiden

Die Eigenschaften hinsichtlich der Reinigbarkeit der Materialien variieren allerdings erheblich je nach Verlegungsart, Einsatzbedingungen, Oberfläche und Umgebung. In der Regel sind Bodenbeläge mit zunehmender Rutschhemmung schwerer zu reinigen.

Die mit der Pflege und Reinigung beauftragte Fachkraft muss für einen jeden Eingriff immer eine empirische Vorabkontrolle vornehmen (möglichst auf nicht verlegtem Material).

Bei besonders schwierigen Einsatzbedingungen (z.B. in Werkstätten oder bei Vorliegen von stark öliger Verschmutzung und Reifenspuren), falscher Verlegung oder unsachgemäß ausgeführter Reinigung übernimmt Atlas Concorde keine Haftung für die Wirksamkeit der Reinigungs- und Pflegearbeiten.

In keinem Fall ist Atlas Concorde für Ereignisse, Schäden oder Mängel verantwortlich, die auf eine falsche Verlegung, nachlässige Reinigung und Pflege oder auf eine ungeeignete Auswahl der verlegten Materialien und verwendeten Kleber für die jeweilige Gebrauchsbestimmung zurückzuführen sind.

Für weiterführende Informationen siehe das „Handbuch für Verlegung, Gebrauch, Reinigung und Pflege“.

## INDEX

PRODUCT  
FINDERSURFACE  
RANGE

## COMPANY



## COLLECTIONS



## LARGE SIZES

TECHNICAL  
SPECIFICATIONS

**SUGERENCIAS PARA LA COLOCACIÓN**

## SUGERENCIAS PARA LA LIMPIEZA Y EL MANTENIMIENTO

**ANTES DE EMPEZAR LA OPERACIÓN DE COLOCACIÓN, SE ACONSEJA ASEGURARSE DE QUE LA SUPERFICIE DE APOYO ESTÉ SUFICIENTEMENTE SECA, PLANA Y BIEN LIMPIA.****1. ELECCIÓN DEL ADHESIVO**

El empleo de un adhesivo adecuado tiene suma importancia para la colocación. Se aconseja atenerse a las indicaciones de los mejores productores de adhesivos para la colocación de baldosas cerámicas. Por lo general, el adhesivo más adecuado se identifica considerando los siguientes factores:

- tipo de soporte;
- tipología y formato de las baldosas;
- destino de uso (pavimento/revestimiento; interiores/exteriores) del revestimiento cerámico;
- condiciones climáticas en el momento de la colocación;
- tiempos a disposición para la puesta en uso del revestimiento cerámico.

DESTINO DE USO Tipo de soporte	TIPO DE BALDOSAS Tipología	FORMATO (cm)	ADHESIVOS RECOMENDADOS - Normativa Europea EN 12004	
			Toma normal	Toma rápida
<b>PAVIMENTOS INTERNOS</b>				
Morteros cementosos Pavimentos de cemento existentes (batido, bujardado)	gres porcelánico	< 30x30 cm	Adhesivos cementosos, mejorados con tiempo abierto prolongado (Clase C2E).	Adhesivos cementosos mejorados, resistentes al deslizamiento y deformables (Clase C2FT - S1). ●
Bloques delgados de anhidrita (previa aplicación de un producto adecuado de imprimación)		≤ 30x30 cm < 60x60 cm	Adhesivos cementosos mejorados, resistentes al deslizamiento con tiempo abierto prolongado (Clase C2TE).	Adhesivos cementosos mejorados, resistentes al deslizamiento y deformables (Clase C2FT - S1). ●
Morteros cementosos calefactores Pavimentos de cerámica, baldosas y piedras naturales existentes Impermeabilización en baños		≥ 60x60 cm	Adhesivos cementosos mejorados, con tiempo abierto prolongado y deformables (Clase C2E - S1).	Adhesivos cementosos mejorados, resistentes al deslizamiento y deformables (Clase C2FT - S1). ●
<b>REVESTIMIENTOS INTERNOS</b>				
Revoque de cemento o mortero, yeso (revoques o paneles, previa aplicación de un producto adecuado de imprimación) Colada de hormigón Yeso encartonado (Prevía aplicación de imprimación en las juntas a base de yeso) Impermeabilizaciones en baños y duchas Baldosas cerámica existentes	revestimientos de pasta blanca	Cualquier formato	Adhesivos cementosos mejorados, resistentes al deslizamiento con tiempo abierto prolongado (Clase C2TE).	Adhesivos cementosos mejorados, resistentes al deslizamiento y deformables (Clase C2FT - S1). ●
	gres porcelánico	< 30x30 cm	Adhesivos cementosos mejorados, resistentes al deslizamiento con tiempo abierto prolongado (Clase C2TE).	Adhesivos cementosos mejorados, resistentes al deslizamiento y deformables (Clase C2FT - S1). ●
		≤ 30x30 cm < 60x60 cm	Adhesivos cementosos mejorados, resistentes al deslizamiento con tiempo abierto prolongado (Clase C2TE).	Adhesivos cementosos mejorados, resistentes al deslizamiento y deformables (Clase C2FT - S1). ●
		≥ 60x60 cm	Adhesivos cementosos mejorados, resistentes al deslizamiento con tiempo abierto prolongado y deformables (Clase C2TE - S1).	Adhesivos cementosos mejorados, resistentes al deslizamiento y deformables (Clase C2FT - S1). ●
<b>PAVIMENTOS EXTERNOS</b>				
Morteros cementosos Soleras de hormigón Capas de impermeabilización	gres porcelánico	< 30x30 cm	Adhesivos cementosos mejorados, resistentes al deslizamiento con tiempo abierto prolongado (Clase C2TE).	Adhesivos cementosos mejorados, resistentes al deslizamiento y deformables (Clase C2FT - S1). ●
		≤ 30x30 cm < 60x60 cm	Adhesivos cementosos mejorados, resistentes al deslizamiento con tiempo abierto prolongado y deformables (Clase C2TE - S1).	Adhesivos cementosos mejorados, resistentes al deslizamiento y deformables (Clase C2FT - S1). ●
		≥ 60x60 cm	Adhesivos cementosos mejorados, con tiempo abierto prolongado y altamente deformables (Clase C2E - S2).	Adhesivos cementosos mejorados, con tiempo abierto prolongado y altamente deformables (Clase C2FE - S2). ●
<b>REVESTIMIENTOS EXTERNOS</b>				
Revoque de cemento Colada de hormigón u hormigón prefabricado	gres porcelánico	< 30x30 cm	s cementosos mejorados, resistentes al deslizamiento con tiempo abierto prolongado y deformables (Clase C2TE - S1).	Adhesivos cementosos mejorados, resistentes al deslizamiento y deformables (Clase C2FT - S1). ●
		≥ 30x30 cm < 60x60 cm ●●	Adhesivos cementosos mejorados, resistentes al deslizamiento con tiempo abierto prolongado y deformables (Clase C2TE - S1).	Adhesivos cementosos mejorados, resistentes al deslizamiento y deformables (Clase C2FT - S1). ●
		≥ 60x60 cm ●●	Adhesivos cementosos mejorados, con tiempo abierto prolongado y altamente deformables (Clase C2E - S2).	Adhesivos cementosos mejorados y altamente deformables (Clase C2F - S2). ●

- En caso de colocación en condiciones de bajas temperaturas o bien si fuera necesario poner en uso rápidamente el revestimiento cerámico, es preferible el empleo de adhesivos cementosos mejorados de fraguado rápido (Clase C2F - EN 12004).
- Para baldosas con lado mayor a 30 cm colocadas a una altura superior a 3 metros, algunas normativas internacionales prevén el empleo de una fijación mecánica suplementaria que asegure la retención de la baldosa en caso de desprendimiento accidental, a elegir según el peso de la baldosa, la altura del revestimiento y las condiciones de la obra.

**2. APLICACIÓN DE LOS ADHESIVOS Y COLOCACIÓN DE LAS BALDOSAS: RECOMENDACIONES**

En caso de colocación de baldosas con un lado cuyo largo supere los 60 cm, y en cualquier caso para ambientes interiores comerciales o bien en el exterior, es fundamental aplicar el adhesivo con el sistema de doble esparcimiento, aplicando la cola de modo lineal en dirección paralela al lado corto. Es muy importante que la dirección de aplicación del adhesivo en el soporte de colocación sea paralela a la aplicada en el revés de la baldosa, garantizando la perfecta adherencia al interfaz baldosa cerámica y el soporte.

Para minimizar los desniveles del sistema de embaldosado en pavimento o de azulejado en revestimiento, se recomienda adoptar "sistemas de colocación facilitada" con distanciadores y niveladores que pueden llevar peanas antidespotrilado y antiarañazos cuando se coloquen baldosas esmaltadas de pasta blanca y/o de gres con acabado lapeado.

En el caso de revestimientos con estructuras tridimensionales, recomendamos el uso de sistemas de nivelación de tipo tornillo como alternativa a los sistemas de tipo cuña. Aplicar el adhesivo sobre el soporte utilizando una espátula con un dentado adecuado.

**GRES PORCELÁNICO & REVESTIMIENTOS****3. EJECUCIÓN DE CORTES CUADRADOS**

Se recomienda realizar inicialmente agujeros circulares cerca de los vértices del corte y unirlos posteriormente mediante cortes lineales, de esta forma se relajarán las tensiones en los vértices de la baldosa cortada.

**4. ESTUCOS RECOMENDADOS**

No se aconseja la colocación de junta unida o colocación con juntas menores a 2 mm.

En el caso de colocación "alternada de las juntas" el escalonado máximo entre las baldosas no tiene que superar 1/3 de la longitud del lado adyacente.

Se recomienda atenerse a las indicaciones de los mejores productores de estucos para juntas.

DESTINO DE USO	ESTUCOS RECOMENDADOS - NORMATIVA EUROPEA EN 13888
Ambientes internos residenciales	Morteros cementosos para juntas mejoradas (Clase CG2)
Ambientes húmedos internos (baños, duchas) y ambientes externos	Morteros cementosos para juntas mejoradas con una reducida absorción de agua (Clase CG2 WA)
Ambientes de uso comercial	Morteros cementosos para juntas mejoradas con una elevada resistencia a la abrasión (Clase CG2 A)
Ambientes en los cuales se requiera una higiene total y resistencia a los agentes químicos (piscinas, encimeras de cocinas, industrias alimenticias, hospitales, supermercados, etc...)	Morteros epoxídicos (Clase RG).

**4a. ELIMINACIÓN DEL ESTUCO EN EXCESO**

Para una eliminación correcta y sencilla de los residuos de estuco, se recomienda seguir las indicaciones del productor del mismo. Por lo general, se recomienda atenerse a las siguientes recomendaciones.

**Estucos de cemento**

Cuando el estuco se vuelve opaco (normalmente al cabo de 10-20 minutos), limpiar con una esponja de celulosa dura con movimientos diagonales respecto a las juntas. Es importante respetar estos tiempos para no correr el riesgo de quitar el estuco de las juntas.

**Estucos epoxídicos**

Con la pasta aún fresca, mojar bien la superficie emulsionando con un estropajo Scotch-Brite®, prestando atención para no vaciar las juntas. El residuo líquido de estuco puede eliminarse con una esponja de celulosa dura (que habrá que cambiar si está demasiado empapada de resina). Es importante eliminar el estuco epoxídico rápidamente antes de que empiece a fraguar, porque quitarlo más tarde resultaría muy difícil. Si el estuco epoxídico ya ha empezado a fraguar, añadir al agua de lavado el 10% de alcohol.

**5. LIMPIEZA Y MANTENIMIENTO****5a. LIMPIEZA FINAL DE LA OBRA**

Al cabo de algunos días, eliminar los restos de la obra con una esponja comercial Scotch-Brite® o bien con un cepillo grande o monocepillo (para grandes superficies).

Para los revestimientos, utilizar un detergente neutro diluido en agua caliente.

Para los pavimentos, utilizar un detergente ácido tamponado, diluido en un porcentaje variable según el tipo de superficie (lisa o estructurada). Es importante proteger preventivamente con cinta adhesiva las inserciones de mármol o metal si estuvieran presentes.

Aclarar abundantemente con agua caliente limpia hasta que desaparezca cualquier halo o residuo en los intersticios.

Si fuera necesario, repetir el lavado ácido con concentraciones más elevadas, excepto si estuvieran presentes inserciones de mármol o metal. Evitar el empleo de ácidos muriáticos de escasa calidad diluidos.

**5b. MANTENIMIENTO ORDINARIO**

Se recomienda el uso de un detergente neutro común diluido en agua.

Evitar el empleo de productos ácidos, alcalinos, productos para encerar y/o impermeabilizantes y bayetas de metal (esponjas de hierro y acero).

En caso de suciedad más intensa o superficies muy estructuradas, usar un detergente de base alcalina aclarando al final del lavado.

En caso de grandes superficies se recomienda el uso de máquinas de lavado y secado.

**5c. MANTENIMIENTO EXTRAORDINARIO**

En caso de restos de suciedad resistentes a la limpieza ordinaria se recomienda el uso de un detergente adecuado dependiendo del tipo de suciedad.

TIPO DE SUCIEDAD (resistente al mantenimiento ordinario)	DETERGENTE/DISOLVENTE
Carbón, eflorescencias calcáreas, yeso, marcas metálicas, óxido, grafito, pinturas murales al temple	Detergentes de base ácida *
Coca cola, café, vino, cerveza, helado	Detergente de base alcalina
Resinas, aceites silicónicos o mecánicos, cera de vela, pintura	Disolventes
Neumáticos, suelas de goma, halos de ventosas	Detergentes básicos en pasta abrasiva

\* Atención: los productos de base ácida pueden corroer el mármol, el granito, las piedras naturales y los metales, por tanto hay que evitar su uso en caso de presencia de decoraciones o inserciones realizadas con estos materiales

Las sugerencias facilitadas arriba son el resultado de investigaciones, comprobaciones de laboratorio y de una experiencia plurianual.

Sin embargo, las características de limpiabilidad de los materiales varían sensiblemente según las diferentes formas de instalación, las condiciones de uso, las tipologías de las superficies y el ambiente. Por lo general, cuanto mayores sean las características antideslizamiento de las baldosas, mayor será la dificultad para limpiarlas.

El profesional encargado del mantenimiento y la limpieza deberá siempre llevar a cabo una comprobación empírica previa (posiblemente en una porción de material no colocado) por cada tipo de intervención.

En caso de condiciones de uso especialmente pesadas (por ejemplo, en talleres mecánicos o en ambientes con una fuerte presencia de residuos oleosos y huellas de neumáticos), instalación incorrecta o limpieza efectuada de manera impropia, Atlas Concorde no se considera responsable de la eficacia de las operaciones de limpieza y mantenimiento.

Se da por descontado que Atlas Concorde no podrá ser considerada responsable de eventos, daños o defectos debidos a una instalación incorrecta, limpieza y mantenimiento negligentes o una elección inadecuada de los materiales instalados y los adhesivos utilizados con respecto al destino.

Para mayor información, consultar el "Manual de Colocación, Uso, Limpieza y Mantenimiento".

INDEX

PRODUCT  
FINDERSURFACE  
RANGE

COMPANY



COLLECTIONS



LARGE SIZES

TECHNICAL  
SPECIFICATIONS

## РЕКОМЕНДАЦИИ ПО УКЛАДКЕ

### ОЧИСТКА И УХОД

#### ПЕРЕД УКЛАДКОЙ РЕКОМЕНДУЕТСЯ ПРОВЕРИТЬ, ЧТО ПОВЕРХНОСТЬ ОСНОВАНИЯ ДОСТАТОЧНО ВЫДЕРЖАНА, РОВНАЯ И ЧИСТАЯ.

#### 1. ВЫБОР КЛЕЯ

Для качества укладки крайне важно правильно подобрать клей. Рекомендуется следовать указаниям крупнейших изготовителей клеев по укладке керамических плиток.

В целом, клей выбирают с учетом следующих критериев:

- тип основания;
- типология и формат плитки;
- назначение (пол/облицовка; внутри/снаружи) керамического покрытия;
- климатические условия в период укладки;
- время на выполнение керамического покрытия.

НАЗНАЧЕНИЕ Тип основания	ТИП ПЛИТКИ Типология	ФОРМАТ (cm)	РЕКОМЕНДУЕМЫЕ КЛЕИ – Европейские Нормы EN 12004	
			Стандартное схватывание	Быстрое схватывание
<b>ВНУТРЕННИЕ НАПОЛЬНЫЕ ПОКРЫТИЯ</b>				
Цементные стяжки Прежние цементные полы (утраббованные) Ангидритные стяжки (предварительно нанести нужную грунтовку) Стяжки с подогревом Укладка на существующие полы из керамики, мраморных плиток и природного камня Гидроизоляция в ванных	Керамогранит	< 30x30 cm	Улучшенные клеи на цементной основе с увеличенным сроком хранения в открытом состоянии (Класс C2E).	Улучшенные эластичные клеи на цементной основе, стойкие к оползанию (Класс C2FT – S1). ●
		≤ 30x30 cm < 60x60 cm	Улучшенные клеи на цементной основе стойкие к оползанию с увеличенным сроком хранения в открытом состоянии (Класс C2TE).	Улучшенные эластичные клеи на цементной основе, стойкие к оползанию (Класс C2FT – S1). ●
		≥ 60x60 cm	Улучшенные клеи на цементной основе, стойкие к оползанию с увеличенным сроком хранения в открытом состоянии и эластичные (Класс C2E – S1).	Улучшенные эластичные клеи на цементной основе, стойкие к оползанию (Класс C2FT – S1). ●
<b>ВНУТРЕННЯЯ ОБЛИЦОВКА</b>				
Цементная штукатурка или раствор Гипс (штукатурка или панели, предварительно нанести нужную грунтовку) Бетонная заливка Гипсовые панели (После нанесения грунтовки на гипсовые швы) Гидроизоляция в ванных и душах Прежние керамические плитки	плитка из белой глины	любой формат	Улучшенные клеи на цементной основе стойкие к оползанию с увеличенным сроком хранения в открытом состоянии (Класс C2TE).	Улучшенные эластичные клеи на цементной основе, стойкие к оползанию (Класс C2FT – S1). ●
		< 30x30 cm	Улучшенные клеи на цементной основе стойкие к оползанию с увеличенным сроком хранения в открытом состоянии (Класс C2TE).	Улучшенные эластичные клеи на цементной основе, стойкие к оползанию (Класс C2FT – S1). ●
		≤ 30x30 cm < 60x60 cm	Улучшенные клеи на цементной основе стойкие к оползанию с увеличенным сроком хранения в открытом состоянии (Класс C2TE).	Улучшенные эластичные клеи на цементной основе, стойкие к оползанию (Класс C2FT – S1). ●
		≥ 60x60 cm	Улучшенные клеи на цементной основе, стойкие к оползанию с увеличенным сроком хранения в открытом состоянии и эластичные (Класс C2E – S1).	Улучшенные эластичные клеи на цементной основе, стойкие к оползанию (Класс C2FT – S1). ●
<b>НАРУЖНЫЕ НАПОЛЬНЫЕ ПОКРЫТИЯ</b>				
Цементные стяжки Бетонное перекрытие Гидроизоляционные слои	Керамогранит	< 30x30 cm	Улучшенные клеи на цементной основе стойкие к оползанию с увеличенным сроком хранения в открытом состоянии (Класс C2TE).	Улучшенные эластичные клеи на цементной основе, стойкие к оползанию (Класс C2FT – S1). ●
		≤ 30x30 cm < 60x60 cm	Улучшенные клеи на цементной основе, стойкие к оползанию с увеличенным сроком хранения в открытом состоянии и эластичные (Класс C2TE – S1)	Улучшенные эластичные клеи на цементной основе, стойкие к оползанию (Класс C2FT – S1). ●
		≥ 60x60 cm	Улучшенные клеи на цементной основе, стойкие к оползанию с увеличенным сроком хранения в открытом состоянии и с большой эластичностью (Класс C2E – S2).	Улучшенные клеи на цементной основе, стойкие к оползанию с увеличенным сроком хранения в открытом состоянии и с большой эластичностью (Класс C2FE – S2). ●
<b>НАРУЖНАЯ ОБЛИЦОВКА</b>				
Цементная штукатурка Бетонная заливка на месте или бетонные блоки	Керамогранит	< 30x30 cm	Улучшенные клеи на цементной основе, стойкие к оползанию с увеличенным сроком хранения в открытом состоянии и эластичные (Класс C2TE – S1)	Улучшенные эластичные клеи на цементной основе, стойкие к оползанию (Класс C2FT – S1). ●
		≥ 30x30 cm < 60x60 cm ●●	Улучшенные клеи на цементной основе, стойкие к оползанию с увеличенным сроком хранения в открытом состоянии и эластичные (Класс C2TE – S1)	Улучшенные эластичные клеи на цементной основе, стойкие к оползанию (Класс C2FT – S1). ●
		≥ 60x60 cm ●●	Улучшенные клеи на цементной основе, стойкие к оползанию с увеличенным сроком хранения в открытом состоянии и с большой эластичностью (Класс C2E – S2).	Улучшенные высокоэластичные клеи на цементной основе (Класс C2F – S2). ●

- При укладке в условиях низкой температуры, если керамическое покрытие требуется быстро ввести в эксплуатацию, предпочтительнее применять быстросхватывающиеся улучшенные клеи на цементной основе (Класс C2F – EN 12004).
- Для плиток с длиной хотя бы одной из граней более 30 см, укладываемых на высоте более 3 метров, некоторые международные стандарты предусматривают дополнительное механическое крепление, например при помощи специальных крюков, для удержания плитки в случае случайного отрыва; крепеж подбирается с учетом веса плитки, высоты облицовки и конкретных условий стройплощадки.

#### 2. НАНЕСЕНИЕ КЛЕЯ И УКЛАДКА ПЛИТКИ: РЕКОМЕНДАЦИИ

При укладке плитки с длиной хотя бы одной из граней более 60 см и, в любом случае, при укладке плитки в коммерческих помещениях или на улице, клей следует

## КЕРАМИЧЕСКИЙ ГРАНИТ & НАСТЕННАЯ ПЛИТКА

наносить в два слоя: на подлежащее облицовке основание и на тыльную сторону плиток прямыми полосами параллельно короткой грани. Чтобы свести к минимуму неровности или перепады высот облицовки, как на полах, так и на стенах, рекомендуется использовать надлежащие крестики и системы выравнивания плитки; при укладке настенной глазурированной плитки из белой глины и (или) лапатированного керамогранита данные системы могут быть оснащены подкладками для защиты от сколов и царапин.

В случае рельефной настенной плитки вместо системы с клиньями рекомендуется использовать винтовую систему выравнивания.

Нанесите клей на основание шпателем с подходящим размером зубьев.

#### 3. ВЫПОЛНЕНИЕ КВАДРАТНЫХ ИЛИ ПРЯМОУГОЛЬНЫХ ОТВЕРСТИЙ

Рекомендуется сначала просверлить круглые отверстия в каждом углу участка реза, затем соединить эти отверстия прямолинейной резкой. Это поможет ослабить напряжения по углам прорезаемого отверстия.

#### 4. ШВЫ И ЗАТИРКА ШВОВ

Не рекомендуется укладывать плитку без швов или со швом менее 2 мм.

При укладке вразбежку смещение плиток должно быть не более 1/3 длины смежных граней.

При затирке швов следуйте указаниям крупнейших производителей шовных затирок.

НАЗНАЧЕНИЕ	РЕКОМЕНДУЕМЫЕ РАСТВОРЫ ЕВРОПЕЙСКИЕ НОРМАТИВЫ EN 13888
Внутренние жилые помещения	Улучшенные цементные растворы для швов (Класс CG2)
Внутренние помещения с высокой влажностью (ванные, души, бассейны и т.п.) и открытые помещения	Улучшенные цементные растворы для швов с низким водопоглощением (Класс CG2 W – EN 13888).
Помещения коммерческого назначения	Улучшенные цементные растворы для швов с повышенной стойкостью к истиранию (Класс CG2 Ar – EN 13888).
Помещения, где требуется полная гигиена и устойчивость к химическим агентам (рабочие столы на кухнях, пищевая промышленность, больницы, супермаркеты и т.п.)	Эпоксидные строительные растворы (Класс RG – EN 13888).

#### 4а. УДАЛЕНИЕ ИЗЛИШКОВ ЗАТИРКИ

Чтобы легко и правильно удалить излишек раствора, рекомендуется следовать указаниям изготовителя раствора.

В общих чертах рекомендуется придерживаться нижеуказанного.

##### Цементные растворы

Когда раствор теряет блеск (обычно через 10–20 минут), счистить его губкой из твердой целлюлозы, проводя ей по диагонали относительно швов.

Очень важно выдержать указанное время, иначе есть риск удалить раствор из швов.

##### Эпоксидные растворы

Пока смесь свежая, обильно смочить поверхность, взбивая эмульсию тампоном Schotch-Brite®; действовать осторожно, чтобы не удалить раствор из швов.

Жидкие остатки раствора можно удалить его губкой из твердой целлюлозы (вовремя заменяя ее, когда она сильно пропитывается смолой). Крайне важно удалить эпоксидный раствор вовремя, пока он не начал затвердевать, так как в дальнейшем это будет чрезвычайно трудно сделать. Если эпоксидный раствор уже начал затвердеть, можно попробовать добавить 10% спирта в воду для смывания.

## 5. ЧИСТКА И УХОД

#### 5а. ЧИСТКА ПО ЗАВЕРШЕНИИ УКЛАДКИ

Через несколько дней очистить уложенное покрытие губкой марки Schotch-Brite® щеткой или механической щеткой (для больших площадей).

Для облицовки применять нейтральное моющее средство, растворенное в горячей воде. Для напольных покрытий применять кислотное моющее средство тампонирующего действия, концентрация раствора меняется в зависимости от типа поверхности (гладкая или шершавая). Не забывать предварительно защитить мраморные или металлические вставки с помощью клейкой ленты. Прополоскать обильным количеством чистой горячей воды, удаляя все разводы и остатки в промежутках. При необходимости повторить кислотную промывку с более сильной концентрацией, за исключением случаев, когда на полу имеются мраморные или металлические вставки. Избегать применения разведенных кислот для металлов.

#### 5б. ТЕКУЩИЙ УХОД

Рекомендуется пользоваться обычным нейтральным моющим средством, разведенным в воде.

Избегать применения кислотных, щелочных, восковых средств, пропиток и металлических губок.

Для удаления сильных загрязнений или для очистки шершавой поверхности с сильно рельефной структурой пользоваться моющим средством на щелочной основе, прополаскивая после мытья.

Для уборки больших площадей рекомендуется пользоваться моечными машинами, которые выполняют мойку и сушку.

#### 5с. ЧРЕЗВЫЧАЙНЫЙ УХОД

Если загрязнения не удаётся удалить обычным способом, рекомендуется применять моющее средство, выбранное с учетом типа загрязнения.

ТИП ЗАГРЯЗНЕНИЙ (устойчивых к обычной уборке)	МОЮЩЕЕ СРЕДСТВО/РАСТВОРИТЕЛЬ
Уголь, кальциевые налеты, гипс, следы от металлов, ржавчина, графит, стенная темпера	Моющие средства на кислотной основе *
Кока-кола, кофе, вино, пиво, мороженое	Моющие средства на щелочной основе
Смолы, силиконовые масла или масла для механического оборудования, свечной воск, краска	Растворители
Шины, резиновые подошвы, следы от присосок	Основания для очистки в виде абразивной пасты

\* Внимание: средства на кислотной основе могут вызвать коррозию мрамора, гранита, природного камня и металлов, поэтому их не следует применять, если имеются декоры или вставки из этих материалов.

Приведенные выше рекомендации являются результатом исследований, лабораторных анализов и многолетнего опыта.

Тем не менее, легкость очистки покрытий значительно меняется при различных способах укладки, условиях эксплуатации, типологиях поверхности и окружающей среды. В целом, чем менее скользкая плитка, тем труднее ее очистить.

Профессиональный работник, отвечающий за уход и очистку, должен всегда провести предварительную пробу (по возможности, на неуложенном материале) по каждому отдельному виду работ.

В случае особо сложных условий (напр., механические мастерские или помещения с большим количеством масляных отходов и следов от шин), ошибок при укладке или неправильного проведения очистки фирма Atlas Concorde снимает с себя всякую ответственность за эффективность операций по очистке и уходу.

Оговаривается, что фирма Atlas Concorde не несет никакой ответственности за происшествия, ущерб или дефекты вследствие ошибок при укладке, халатной очистки и небрежного ухода или неправильного выбора типа устанавливаемых покрытий и клеев для конкретного назначения.

**GENERAL SALES CONDITIONS****A.- CONTRACT COMPLETION**

**A.1.** These general sales conditions govern every sales contract between the Seller and the Buyer and any amendment or exception thereof shall be agreed in writing.

**A.2.** Any offers, credits and/or rebates granted by agents or other intermediaries, shall not be considered valid if they are not confirmed in writing by the Seller.

**A.3.-** The Buyer shall send the written orders to the Seller, directly or through the agents, and the orders shall include the codes of the required products, quantity, price and destination. The order sent by the Buyer is irrevocable.

**A.4.** The sale shall be deemed completed when: (i) the Buyer receives a written confirmation from the Seller, via e-mail, fax or other electronic means, that complies with the terms and conditions of the order; or (ii) if the confirmation sent by the Seller contains conditions that differ from the order sent by the Buyer, when the latter accepts it in writing or in any case does not object within 7 (seven) days from reception; or (iii) if the Seller does not provide a written confirmation, when the products are delivered and loaded by the Buyer.

**A.5.** The Buyer shares the need to restrict the sales of Atlas Concorde products to the national territory. The Seller deems this rule necessary in order to coordinate its sales policy, streamline its distribution network and provide offers that are suited to the needs of the single countries. The Buyer acknowledges that this rule is also in its best interest. The Buyer therefore undertakes to market the products supplied by Ceramiche Atlas Concorde SpA exclusively in its country of residence, refraining from promoting active sales, even online, with customers located in the territory of a country different from its own. As regards triangular operations, this undertaking applies to the country in which the buyer actually operates. The Buyer may resell the product outside its territory only with written authorisation from the Seller, or if the sales concern non first-grade products or products that are out of production.

**B.- PRICES**

**B.1.** The prices agreed upon for each individual sale are net prices for cash delivery ex works (the Seller's plant shall be specified in the order confirmation), unless otherwise agreed in writing.

**C.- PRODUCT CHARACTERISTICS**

**C.1.** The Buyer declares to have read and comply with the content of the following documentation published on the corporate website: 1) Laying, use, cleaning and maintenance manual and 2) Technical data sheets.

**C.2.** Given the intrinsic variability of the ceramic products, the characteristics of the samples, previously sent by the Seller to the Buyer, are purely illustrative and cannot be deemed binding.

**C.3.** Unless specifically requested and agreed before the order confirmation, the Seller does not guarantee that the entire quantity of an article on order shall be sent from one same production lot.

**D.- DELIVERY TERMS**

**D.1.** The delivery terms are understood to be indicative and the extension thereof cannot entitle the Purchaser to request any form of compensation, without exception.

**D.2.** If, after 14 (fourteen) days from the date of notification that the goods are ready, the Purchaser fails to collect them, the Seller shall be forced for reasons of occupied space to return the goods to the storage facilities, thereby incurring additional costs; the Seller reserves the right to charge the Purchaser such additional costs.

**E.- SHIPPING ARRANGEMENTS AND TERMS**

**E.1.** The Buyer must communicate any variation in the destination of the products, different from the one agreed in the order confirmation, in writing within, and no later than, the second day before the day foreseen for the collection at the Seller's premises. The Seller reserves the right not to accept the change of the product destination. If the actual destination of the product is different from the one stated by the Buyer, the Seller reserves the right to suspend the execution of the supplies underway and/or to terminate the contracts in force and the Buyer shall not have the right to claim direct and/or indirect compensation of any type.

**E.2.** Unless otherwise agreed, the goods shall be delivered ex-works (EXW – Incoterms 2010) and this shall also be the case when the parties agree that the delivery, or part of it, shall be arranged by the Seller on the Buyer's behalf. In any case, the risks shall transfer to the Buyer upon delivery to the first carrier.

**E.3.** Without prejudice to the Seller's extraneity in relation to the transport contract, the Seller shall not be indicated as "shipper" on the bill of lading. The communication of the gross weight of the container to the Forwarding agent does not represent in any way the undertaking of any liability by the Seller as regards the SOLAS (Safety Of Life At Sea) Convention. In no event may the said communication be taken to be the VGM (Verified Gross Mass).

**E.4.** The Buyer undertakes to ensure that the vehicle sent to the Seller's warehouse is suitable for the loading operations, considering the nature of the products. If the vehicle sent to collect the goods causes difficulties in the loading operations, the Seller reserves the right to charge a penalty, of 4% of the value of the products, to cover the extra logistics costs. If the vehicle sent is not at all suitable, the Seller reserves the right to refuse to load the goods and the Buyer shall not have the right to claim compensation for any direct and/or indirect cost that may arise therefrom.

**E.5.** The Buyer is responsible for assigning the carrier the task of checking the products before loading them; any observations concerning the condition of the packaging and the correspondence of the quantities loaded with those on the transport document must be made by the carrier upon collection of the goods. The said observations must be written on all the copies of the transport documents, otherwise the loaded products shall be considered to be complete and in good condition. As a result, the Seller shall not be liable for any missing or damaged products not reported by the carrier.

**E.6.** The Buyer is also responsible for assigning the carrier the task of checking the loading procedure and the stability of the goods on the vehicle, in order to prevent damage during transport and to comply with all road safety provisions.

**F.- PAYMENTS**

**F.1.** All payments must be made to the Seller's registered office. Payments made to agents, representatives, or sales assistants shall not be considered as made until the amounts are received by the Seller.

**F.2.** The Buyer shall not fulfil its payment obligations by making payments from countries other than its own country of residence, if the said countries do not guarantee an adequate exchange of information with Italy. In case of breach of the said prohibition, the Seller has the right to terminate the contract for just cause and the Buyer shall not have the right to claim compensation for any damage suffered.

**F.3.** Any costs for stamp duty and bank draft fees shall be borne by the Buyer. Failure to fulfil, even only in part, the payment shall result in the application of interest on arrears in favour of the Seller, from the date established for the payment, as envisaged by legislative decree 09/10/2002 no. 231.

**F.4.** Unless otherwise agreed in writing, the Buyer undertakes not to offset any receivables, of whatever nature, owed by the Seller.

**G.- CLAIMS**

**G.1.** Upon receipt of the products, the Buyer shall perform a visual inspection in compliance with instructions provided in point 7 of UNI EN ISO 10545-2 standards.

**G.2.** The products must be installed and fitted strictly respecting the recommendations related to the activities to be performed before and during the laying of the product specified in document 1) Laying, use, cleaning and maintenance manual, published on the Seller's website, and on the product packaging and/or inside the packaging. Faults caused by an incorrect installation and by missing/incorrect maintenance (different from instructions provided in document 1) Laying, use, cleaning and maintenance manual), by an unsuitable use and/or by normal wear over time shall not be considered product faults.

**G.3.** With the exception of the limits of acceptability foreseen by the international EN 14411 (ISO 13006) standard, the parties acknowledge as identifiable faults those product defects that are immediately visible upon receipt thereof and that make the material unsuitable for use or that significantly reduce its value. This category includes faults as defined in the document 1) Laying, use, cleaning and maintenance

manual, published on the Seller's website. Identifiable faults include, by way of a non-limiting example, superficial defects, decoration defects, defects concerning polishing, dimensions, surface flatness, straightness of sides/rectangularity and thickness, cracks, chippings or rough edges, non-compliant shades, mixed shades and products that feature problems deriving from the cutting process and/or from chips.

**G.4.** If the Buyer finds an identifiable fault, it must be reported in writing to the Seller, within 8 (eight) days from receipt of the products; failure to send the claim shall result in the forfeiture and loss of such right. The Buyer shall keep the entire lot of material readily available for the Seller. The claim shall include the invoice details and an accurate description of the claimed fault together with photographs, where possible. In the event that the claim proves to be unfounded, the Buyer shall refund the Seller any costs incurred for an inspection (expert's reports, travel, etc.).

**G.5.** Hidden faults shall be notified to the Supplier in writing, by recorded delivery letter with advice of receipt, within 8 days from the date such fault is found, under penalty of forfeiture.

**G.6.** The Buyer's right to make a claim for faults under warranty is valid for 12 (twelve) months from the delivery of the products.

**H.- WARRANTY FOR FAULTS**

**H.1.** The Seller's warranty is limited to first grade products and not second or third grade products or lots on offer with special prices or discounts, which must be duly specified with a note in the order confirmation.

**H.2.** The Seller does not guarantee the suitability of the products for particular uses, and only guarantees the technical specifications published on the website in the document 2) Technical data sheets. The indication for use is merely indicative, even when written in the Seller's catalogues and manuals. On the basis of the characteristics described in the document 2) Technical data sheets, the designer always has the task of assessing the suitability of the product for the specific use conditions, taking into account the stress and variables to which the product will be subjected, (which may alter its characteristics; for example, the traffic intensity, quality of traffic (foot traffic with the presence of sand, debris...), adverse weather conditions and any other unpredictable factor to which the material may be exposed.

**H.3.** In the event that identifiable product faults are ascertained, as defined in sub section G no. 3, the Seller shall replace the faulty product with another one with equal or superior characteristics; should this not be possible, the Seller shall apply a significant price reduction. Alternatively, following the return of the faulty products, the Buyer shall have the right to a refund of the price paid plus the transport cost, with the exclusion of compensation for any other direct and/or indirect damage.

**H.4.** The Seller's warranty shall not be valid if the products that have identifiable faults (totally or in part) have been used and/or in any case transformed, as this entails that the Buyer (or its customer) expressed the intention to accept them in the condition in which they were found.

**H.5.** In the event that hidden product faults are ascertained, the Seller's warranty is limited to the replacement with other products of equal or superior characteristics; should this not be possible the Seller shall refund the price paid plus the transport cost. In any case, the Seller's warranty for any direct and/or indirect damage caused by the faulty product, shall be limited to an amount that shall not be greater than double the selling price applied by the Seller, only in relation to the faulty part of the supply.

**H.6.** In the event that the Buyer resells the product to subjects protected by the consumer code (law decree no. 206/2005), the former shall be responsible for the conditions applied, if different from those stated herein, and shall ensure that the consumer's rights are exercised, in relation to the remedies and terms established by the said code. If there are the grounds for the Buyer to exercise the right of recourse and/or make a claim against the Seller/manufacturer, the said action shall take into account or go beyond the exemptions and limits established in sub sections G no. 1 and H no. 5.

REV.3 OF 1<sup>ST</sup> SEPTEMBER 2020**I. SOLVE ET REPETE (pay and then claim) AND TERMINATION CLAUSES**

**I.1.** Pursuant to article 1462 of the Italian Civil Code, on no account may the Buyer suspend or delay payment of collected material, including in the event of alleged defects or faults in the material; this does not affect the right to claim back any payments made unduly (solve et repete).

**I.2.** If the Buyer's financial situation changes or in the event of non-payment (even partial) of products already supplied, the Seller reserves the right to suspend the execution of the supplies underway and/or to terminate the contracts in force and the Buyer shall not have the right to claim direct and/or indirect compensation of any type.

**L.- RETENTION OF OWNERSHIP**

**L.1.** The products supplied shall remain exclusive property of the Seller until the Buyer has paid the full amount.

**L.2.** During the aforementioned period, the Buyer shall undertake the obligations and responsibilities as bailee (also referred to as custodian) and shall not transfer the said products, grant their use, let them be seized or distrained without declaring that the property is of the Seller, and the Buyer shall immediately inform the Seller by recorded delivery letter with advice of receipt.

**M.- FORCE MAJEURE**

**M.1.** Each party may suspend the fulfilment of its contractual obligations, when the said fulfilment is impossible or objectively too costly due to an unforeseeable impediment independent from the parties, such as for example: strike, boycott, lockout, fire, war (declared or not), civil war, riots and revolutions, requisitions, embargo, power blackouts, extraordinary breakage of machinery, delays in the delivery of components or raw materials.

**M.2.** The party that wishes to apply this clause shall immediately notify the onset and end of the circumstances of force majeure to the other party in writing.

**M.3.** If the suspension due to force majeure lasts longer than 60 (sixty) days, each party shall have the right to terminate this contract, with a notice of 10 (ten) days to be notified to the counterparty in writing.

**N.- CONFIDENTIALITY**

**N.1.** The Buyer undertakes to maintain confidentiality as regards all information of a technical (such as, by way of a non-limiting example, drawings, tables, documentation, formulas and correspondence) and commercial nature (including contractual conditions, purchase prices, payment conditions,...) gained during the performance of this contract.

**N.2.** The confidentiality obligation shall be undertaken for the entire duration of this contract and for the period following its execution.

**N.3.** In case of failure to uphold the confidentiality obligation, the non-fulfilling party shall pay the other party compensation for all damages that may derive therefrom.

**O.- SELLER'S TRADEMARKS AND DISTINCTIVE SIGNS**

**O.1.** The use of trademarks, ornamental designs and creative works in general, in whatever form and manner of expression (such as, by way of a non-limiting example: images, photos, drawings, videos, shapes, structures, etc.) constituting the Seller's intellectual property, through any means (such as, by way of a non-limiting example: press, video, radio, internet, social media, instant messaging platforms or VoIP, etc.) is strictly forbidden. Any exception to the said prohibition, even only partial, must be authorised in writing, each time, by the Seller's general management.

**P.- CONTRACT LANGUAGE, APPLICABLE LAW, JURISDICTION AND AUTHORITY**

**P.1.** The present contract is drafted in Italian, and in case of disputes the said version shall prevail over any translations in other languages.

**P.2.** Any dispute concerning the supply of products shall be subject to Italian law and jurisdiction and the Court of Modena, the town in which the Seller has its registered office, shall have sole local jurisdiction.

For more information refer to the General Conditions of Sale, available at [www.atlasconcorde.com](http://www.atlasconcorde.com)

INDEX

PRODUCT  
FINDERSURFACE  
RANGE

COMPANY



COLLECTIONS



LARGE SIZES

TECHNICAL  
SPECIFICATIONS

## CONDIZIONI GENERALI DI VENDITA

### A.- MODALITA' DI CONCLUSIONE DEL CONTRATTO

**A.1.** Le presenti Condizioni Generali di Vendita disciplinano ogni contratto di Vendita tra il Venditore e l'Acquirente ed ogni loro modifica o deroga deve essere concordata per iscritto.

**A.2.** Eventuali offerte, accrediti e/o abbuoni accordati da agenti o da altri intermediari, non sono ritenuti validi se non confermati per iscritto dal Venditore.

**A.3.** L'Acquirente invia al Venditore, direttamente o per il tramite di agenti, Ordini scritti che devono contenere l'indicazione dei codici dei Prodotti richiesti, delle quantità, del loro prezzo e della destinazione. L'Ordine inviato dall'Acquirente è irrevocabile.

**A.4.** La Vendita dovrà ritenersi conclusa nel momento in cui: (i) l'Acquirente riceva da parte del Venditore una Conferma scritta via e-mail, fax o altri mezzi telematici, conforme ai termini e alle condizioni dell'Ordine; o (ii) in caso di Conferma inviata dal Venditore contenente condizioni difformi dall'Ordine ricevute dall'Acquirente quando questi l'accetti per iscritto o comunque non la contesti entro 7 (sette) giorni dalla ricezione; o (iii) in assenza di conferma scritta da parte del Venditore, nel momento

in cui i Prodotti saranno consegnati e caricati dall'Acquirente.

**A.5.** L'Acquirente condivide l'esigenza di limitare al territorio nazionale le vendite di prodotti Atlas Concorde. Il Venditore ritiene questa regola elemento indispensabile per permettergli di coordinare la sua politica commerciale e razionalizzare la rete distributiva, con offerte più orientate alle necessità dei singoli Paesi.

Parimenti, l'Acquirente riconosce che tale esigenza costituisce una tutela anche dei propri interessi.

L'Acquirente si obbliga quindi a commercializzare i prodotti forniti da Ceramiche Atlas Concorde SpA esclusivamente nel suo Paese di residenza, astenendosi dal promuovere vendite attive sollecitate anche online con clienti situati nel territorio di uno Stato diverso dal proprio. Per le operazioni triangolari il presente obbligo si applica al Paese di effettiva operatività dell'acquirente. L'Acquirente potrà rivendere il prodotto al di fuori dal proprio territorio nel caso in cui riceva autorizzazione per iscritto da parte del Venditore, o nel caso in cui la rivendita riguardi prodotti non di prima scelta, oppure prodotti fuori produzione.

### B.- PREZZI

**B.1.** Salvo diversa pattuizione scritta, i prezzi di vendita concordati di volta in volta si intendono al netto per contanti e per consegna franco stabilimento del Venditore indicato nella Conferma d'Ordine.

### C.- CARATTERISTICHE DEI PRODOTTI

**C.1.** L'Acquirente dichiara di aver preso visione ed attenersi al contenuto della seguente documentazione pubblicata nel sito internet aziendale: 1) Manuale di Posa, Uso, Pulizia e Manutenzione e 2) Schede tecniche.

**C.2.** Data la intrinseca variabilità del prodotto ceramico, le caratteristiche dei campioni e/o modelli inviati in precedenza dal Venditore all'Acquirente sono da considerarsi indicativi e non vincolanti.

**C.3.** Salvo specifiche richieste da concordare prima della Conferma d'Ordine, il Venditore non garantisce che l'ordine del singolo articolo venga evaso tutto con un medesimo lotto di produzione.

### D.- TERMINI DI CONSEGNA

**D.1.** I termini di consegna sono da intendersi indicativi e la proroga di essi non può far maturare all'Acquirente alcun diritto a richiedere indennizzi, ogni eccezione rimossa.

**D.2.** Se, trascorsi 14 (quattordici) giorni dalla data di avviso di merce pronta, l'Acquirente non ritira il materiale, il Venditore sarà costretto per ragioni di spazio occupato a riportare il materiale nelle locazioni di deposito, sostenendo quindi costi supplementari; il Venditore si riserva la possibilità di addebitare tali costi supplementari all'Acquirente.

### E.- RESA E SPEDIZIONE

**E.1.** L'eventuale variazione della destinazione dei Prodotti, diversa da quella concordata in Conferma d'Ordine, deve essere comunicata dall'Acquirente per iscritto entro e non oltre il secondo giorno antecedente a quello previsto per il ritiro presso la sede del Venditore. Il Venditore si riserva la facoltà di non accettare la variazione della destinazione dei Prodotti. Nel caso si verifichi che la destinazione effettiva del Prodotto sia stata diversa da quella dichiarata dall'Acquirente, il Venditore si riserva la facoltà di sospendere l'esecuzione delle forniture in corso e/o risolvere i contratti in corso senza che l'Acquirente possa rivendicare risarcimenti

diretti e/o indiretti di alcun tipo.

**E.2.** Salvo patto contrario, la fornitura della merce si intende Franco Fabbrica (EXW ai sensi degli Incoterms 2010) e ciò anche quando sia convenuto che la spedizione o parte di essa venga curata dal Venditore su mandato dell'Acquirente. In ogni caso i rischi passano all'Acquirente al più tardi con la consegna al primo trasportatore.

**E.3.** Ferma restando l'estraneità del Venditore rispetto al contratto di trasporto, il Venditore non potrà essere indicato come "shipper" nella polizza di carico. La comunicazione del peso lordo del container allo spedizioniere, non costituisce alcuna assunzione di responsabilità da parte del Venditore ai fini della Convenzione SOLAS (Safety Of Life At Sea). In nessun caso tale comunicazione potrà essere intesa come VGM (Verified Gross Mass).

**E.4.** L'Acquirente s'impegna affinché il mezzo inviato presso i magazzini del Venditore sia idoneo al carico in relazione alla natura dei Prodotti. Nel caso il mezzo che si presenta comporti significative difficoltà per le operazioni di carico, il Venditore si riserva di addebitare una penale pari al 4% del valore dei prodotti a copertura dei maggiori costi logistici. Se il mezzo convenuto non è assolutamente idoneo, il Venditore si riserva la facoltà di negare le operazioni di carico senza che nulla possa essere richiesto dall'Acquirente a titolo di risarcimento per ogni onere diretto e/o indiretto che ne possa derivarne.

**E.5.** È compito dell'Acquirente incaricare il vettore di controllare i prodotti prima del carico; eventuali osservazioni in relazione all'integrità degli imballi e della rispondenza delle quantità caricate a quelle indicate sul documento di trasporto, devono essere sollevate dal vettore al momento del carico. Tali osservazioni devono essere riportate su tutte le copie dei documenti di trasporto, altrimenti i prodotti caricati s'intendono integri e completi. Ne deriva che il Venditore non si assume alcuna responsabilità in relazione a mancanze o danni dei prodotti non segnalati dal vettore.

**E.6.** È altresì responsabilità dell'Acquirente incaricare il vettore di verificare le modalità e la stabilità del carico sul mezzo affinché durante il trasporto non si verifichino rotture e affinché siano rispettate tutte le disposizioni di sicurezza riguardanti la circolazione stradale.

### F.- PAGAMENTI

**F.1.** Qualsiasi obbligazione di pagamento deve essere adempiuta presso la sede legale del Venditore. Eventuali pagamenti ad agenti, rappresentanti o ausiliari di commercio non si intendono effettuati finché le relative somme non pervengono al Venditore.

**F.2.** È fatto divieto all'Acquirente di eseguire il proprio adempimento mediante pagamenti provenienti da paesi diversi dal proprio paese di residenza se trattasi di paesi che non garantiscono un adeguato scambio di informazioni con l'Italia. In caso di violazione di tale divieto, il Venditore ha facoltà di risolvere il contratto per giusta causa senza che l'Acquirente possa vantare il diritto di ottenere alcun risarcimento per l'eventuale danno subito.

**F.3.** Eventuali spese di bollo ed incasso effetti e tratte sono a carico dell'Acquirente. In caso di inadempimento, anche solo parziale, dal giorno fissato per il pagamento decorreranno a favore del Venditore gli interessi moratori nella misura prevista dal d.lgs. 09/10/2002 n. 231.

**F.4.** Salvo diversi accordi scritti, l'Acquirente si impegna a non compensare alcun credito, comunque insorto, nei confronti del Venditore.

### G.- RECLAMI

**G.1.** Al ricevimento dei Prodotti, l'Acquirente dovrà sottoporli ad accurato controllo attraverso un esame visivo effettuato conformemente alle indicazioni riportate al punto 7 delle norme UNI EN ISO 10545-2

**G.2.** L'installazione e la posa dei Prodotti deve essere effettuata attenendosi scrupolosamente alle raccomandazioni inerenti le attività da svolgere prima e durante la posa in opera indicate nel documento 1) Manuale di Posa, Uso, Pulizia e Manutenzione pubblicato nel sito internet del Venditore e sulla confezione del prodotto e/o all'interno della stessa. Non sono considerati vizi del Prodotto quelli generati da un'errata installazione e dalla mancata/errata manutenzione (difformi dalle indicazioni fornite nel 1) Manuale di Posa, Uso, Pulizia e Manutenzione), da una non idonea destinazione d'uso e/o dalla normale usura nel tempo.

**G.3.** Fatti salvi i limiti di accettabilità previsti dalla norma internazionale EN 14411 (ISO 13006), le Parti riconoscono come Vizi Palesi i difetti dei Prodotti riscontrabili già al momento del loro ricevimento tali da rendere il materiale inidoneo all'uso o da diminuirne in modo apprezzabile il valore. Rientrano in tale categoria i difetti

come definiti nel documento 1) Manuale di Posa, Uso, Pulizia e Manutenzione pubblicato nel sito internet del Venditore. A titolo esemplificativo e non esaustivo si riconoscono come Vizi Palesi i difetti superficiali, i difetti di decorazione, di lappatura/levigatura, di calibro, di planarità, di ortogonalità-rettilinearità, di spessore, le crepe, le sbecature, i fuori tono, i toni mescolati e i Prodotti che presentano problemi da taglio/scaglie.

**G.4.** Nel caso l'Acquirente rilevi Vizi Palesi dovrà fare reclamo al Venditore per iscritto, a pena di decadenza, entro 8 (otto) giorni dal ricevimento e tenere a disposizione del Venditore l'intera partita di materiale. Il reclamo dovrà riportare i dati di fatturazione e una precisa descrizione del vizio reclamato corredata, quando possibile, da immagini fotografiche. Qualora il reclamo dovesse risultare infondato, l'Acquirente si rende disponibile a risarcire il Venditore delle spese sostenute per l'eventuale sopralluogo (perizie, viaggi ecc.).

**G.5.** I Vizi Occulti dovranno essere notificati al Venditore mediante lettera raccomandata A.R., a pena di decadenza dalla garanzia, entro 8 (otto) giorni dalla data della scoperta del difetto.

**G.6.** L'azione dell'Acquirente diretta a fare valere la garanzia per vizi si prescrive comunque nel termine di 12 (dodici) mesi decorrenti dalla consegna dei Prodotti.

### H.- GARANZIA PER VIZI

**H.1.** La garanzia del Venditore si intende limitata ai soli Prodotti di prima scelta e non ai Prodotti di seconda o terza scelta o di partite d'occasione con prezzi o sconti particolari quando debitamente segnalati in nota nella Conferma dell'Ordine.

**H.2.** Il Venditore non garantisce l'idoneità dei Prodotti ad usi particolari, ma soltanto le caratteristiche tecniche pubblicate nel sito internet nel documento 2) Schede tecniche. L'indicazione d'uso, anche quando presentata dal Venditore in cataloghi e manuali, è da ritenersi puramente indicativa. Sulla base delle caratteristiche tecniche riportate nelle 2) Schede Tecniche è sempre compito del progettista valutare l'idoneità del Prodotto alle condizioni specifiche di utilizzo in funzione delle sollecitazioni e delle variabili che si possono verificare nell'ambiente di destinazione alterandone le sue caratteristiche, a titolo d'esempio, all'intensità del traffico, alla qualità del traffico (calpestio in presenza di sabbia, di detriti...), alle eventuali condizioni climatiche avverse e a qualsiasi altra aleatorietà a cui può essere esposto il materiale.

**H.3. Nel caso risulti accertato che il Prodotto manifesti Vizi Palesi, come definiti al sub lett. G n.3, il Venditore provvederà alla sostituzione del Prodotto difettoso con altro avente caratteristiche pari o superiori o nel caso ciò non sia possibile ad una congrua riduzione del prezzo. In alternativa l'Acquirente avrà diritto, previa restituzione dei Prodotti viziati, al rimborso del prezzo pagato, maggiorato del costo del trasporto, con esclusione del risarcimento di ogni altro danno diretto e/o indiretto.**

**H.4. La garanzia del Venditore deve ritenersi esclusa nel caso in cui il Prodotto affetto da Vizi Palesi (in tutto o in parte) sia stato utilizzato e/o comunque trasformato dovendosi ritenere che in tal modo l'Acquirente (o il suo cliente) abbia espresso la volontà di accettarli nello stato in cui si trovano.**

**H.5.** Nel caso risulti accertato che il Prodotto manifesti Vizi Occulti, la garanzia del Venditore è limitata alla sostituzione del materiale con altro avente caratteristiche pari o superiori e ove ciò non sia possibile al rimborso del prezzo pagato maggiorato del costo del trasporto. In ogni caso la garanzia del Venditore per ogni danno diretto e/o indiretto comunque originato dal prodotto difettoso, deve intendersi limitata ad una somma che non potrà superare il doppio del prezzo di vendita applicato dal Venditore in relazione alla sola parte della fornitura difettosa.

**H.6.** Nel caso l'Acquirente rivenda il Prodotto a soggetti tutelati dal codice del consumo (d.l. n.206/2005) sarà responsabile delle condizioni praticate se difformi da quelle qui riportate e dovrà accertarsi che i diritti del consumatore siano esercitati nel rispetto dei rimedi e dei termini fissati da tale codice. Nel caso sussistano i presupposti, il diritto di regresso e/o comunque di rivalsa spettanti all'Acquirente verso il Venditore/produttore non potrà eccedere le esenzioni ed i limiti come fissati dal sub lett. G n.1 al sub lett. H n.5.

### I. CLAUSOLE SOLVE ET REPETE E RISOLUTIVE

**I.1.** Ai sensi dell'art. 1462 del Codice Civile, per nessun motivo, ivi compresi pretesi vizi o difetti del materiale, l'Acquirente potrà sospendere o ritardare il pagamento del materiale ritirato, salva naturalmente la facoltà di ripetere quando possa dimostrare di avere indebitamente pagato.

**I.2.** Nel caso di mutamento delle condizioni patrimoniali dell'Acquirente o di mancato pagamento anche parziale di prodotti già forniti, il Venditore può **sospendere**

REV. 3 DEL 1 SETTEMBRE 2020

l'esecuzione delle forniture in corso e/o risolvere i contratti in corso senza che l'Acquirente possa rivendicare risarcimenti diretti e/o indiretti di alcun tipo.

### L.- PATTO DI RISERVATO DOMINIO

**L.1.** Fino a quando l'Acquirente non avrà provveduto all'integrale pagamento del prezzo, i Prodotti oggetto della fornitura rimarranno di proprietà del Venditore.

**L.2.** Durante il periodo suddetto, l'Acquirente assumerà gli obblighi e le responsabilità del custode, e non potrà alienare, dare in uso, lasciare sequestrare o pignorare tali Prodotti senza dichiarare la proprietà del Venditore e dare immediato avviso a mezzo raccomandata A.R.

### M.- FORZA MAGGIORE

**M.1.** Ciascuna parte potrà sospendere l'esecuzione dei suoi obblighi contrattuali quando tale esecuzione sia resa impossibile o oggettivamente troppo onerosa da un impedimento imprevedibile indipendente dalla sua volontà, quale ad esempio: sciopero, boicottaggio, serrata, incendio, guerra (dichiarata o non), guerra civile, sommosse e rivoluzioni, requisizioni, embargo, interruzioni di energia, rotture straordinarie di macchinari, ritardi nella consegna di componenti o materie prime.

**M.2.** La parte che desidera avvalersi della presente clausola dovrà comunicare immediatamente per iscritto all'altra parte il verificarsi e la cessazione delle circostanze di forza maggiore.

**M.3.** Qualora la sospensione dovuta a forza maggiore duri più di 60 (sessanta) giorni, ciascuna parte avrà il diritto di risolvere il presente contratto, previo un preavviso di 10 (dieci) giorni, da comunicarsi alla controparte per iscritto.

### N.- OBBLIGO DI RISERVATEZZA

**N.1.** L'Acquirente è tenuto ad osservare la più assoluta riservatezza su tutte le notizie di carattere tecnico (quali, in via meramente esemplificativa, disegni, prospetti, documentazioni, formule e corrispondenza) e di carattere commerciale (ivi comprese le condizioni contrattuali, i prezzi d'acquisto, le condizioni di pagamento ...) apprese in esecuzione del presente Contratto.

**N.2.** L'obbligo di riservatezza viene assunto per tutta la durata del Contratto, nonché per il periodo successivo alla sua esecuzione.

**N.3.** In ogni caso di inosservanza dell'obbligo di riservatezza, la parte inadempiente è tenuta e risarcire all'altra tutti i danni che ne dovessero derivare.

### O.- MARCHI E SEGNI DISTINTIVI DEL VENDITORE

**O.1.** L'utilizzo dei marchi, dei modelli ornamentali e delle opere d'ingegno in genere, in qualunque forma o modo di espressione (quali a titolo meramente esemplificativo, ma non esaustivo: immagini, foto, disegni, filmati, figure, strutture, etc.) costituenti proprietà intellettuale del Venditore, attraverso qualsiasi mezzo (quali a titolo meramente esemplificativo, ma non esaustivo: stampa, video, radio, internet, social media, piattaforme di messaggistica istantanea o VoIP, etc.) è severamente vietato. Qualsiasi deroga a tale divieto, anche solamente parziale, dovrà essere autorizzata per iscritto, caso per caso, dalla Direzione generale del Venditore.

### P.- LINGUA DEL CONTRATTO, LEGGE APPLICABILE, GIURISDIZIONE E COMPETENZA

**P.1.** Il Contratto e le presenti condizioni sono redatti in lingua Italiana, la quale prevarrà nel caso di divergenza con la traduzione in altre lingue.

**P.2.** La definizione di qualsiasi controversia comunque relativa alle forniture è soggetta alla legge ed alla giurisdizione dello Stato Italiano e la competenza territoriale viene devoluta in via esclusiva al Tribunale di Modena nella cui circoscrizione il Venditore ha la sua sede legale.

Per maggiori informazioni riferirsi alle Condizioni Generali di Vendita, disponibili all'indirizzo [www.atlasconcorde.com](http://www.atlasconcorde.com)

INDEX



PRODUCT  
FINDER



SURFACE  
RANGE



COMPANY



COLLECTIONS



LARGE SIZES



TECHNICAL  
SPECIFICATIONS



## CONDITIONS GÉNÉRALES DE VENTE

### A.- MODALITÉS DE CONCLUSION DU CONTRAT

**A.1.** Les présentes Conditions Générales de Vente régissent tout contrat de Vente entre le Vendeur et l’Acheteur et toute modification ou dérogation de ces dernières doit être convenue par écrit.

**A.2.** D'éventuelles offres, accréditations et / ou ristournes accordées par des agents ou par d'autres intermédiaires, ne seront réputées valables que si elles sont confirmées par écrit par le Vendeur.

**A.3.** L’Acheteur envoie au Vendeur, directement ou par l’intermédiaire d’agents, des Commandes écrites qui doivent indiquer les codes des Produits demandés, les quantités, leur prix et leur destination. La commande envoyée par l’Acheteur est irrévocable.

**A.4.** La Vente doit être réputée conclue au moment où: (i) l’Acheteur reçoit de la part du Vendeur une Confirmation écrite par e-mail, par télécopie ou par d'autres moyens télématiques, conforme aux conditions de la Commande ; ou (ii) en cas de Confirmation envoyée par le Vendeur contenant des conditions différant de la Commande envoyée par l’Acheteur lorsque celui-ci l’accepte par écrit ou quoi qu'il en soit s'il ne la conteste pas dans un délai de 7 (sept) jours à compter de la réception ; ou (iii) en l’absence d’une confirmation écrite de la part du Vendeur, au moment où les Produits seront livrés et chargés par l’Acheteur.

**A.5.** L’Acheteur partage l'exigence de limiter les ventes de produits Atlas Concorde au territoire national. Le Vendeur considère cette règle comme un élément indispensable lui permettant de coordonner sa politique commerciale et de rationaliser le réseau de distribution, avec des offres davantage orientées vers les exigences des différents Pays. De même, l’Acheteur reconnaît que cette exigence constitue également une mesure de protection de ses propres intérêts. L’Acheteur s’engage donc à commercialiser les produits fournis par Ceramiche Atlas Concorde SpA exclusivement dans son Pays de résidence, en s’abstenant de promouvoir les ventes actives également sollicitées en ligne auprès de clients situés sur le territoire d’un État différent du sien.

Pour les opérations triangulaires, la présente obligation s’applique au pays dans lequel l’acheteur opère effectivement. L’Acheteur pourra revendre le produit hors de son territoire avec l’autorisation écrite du Vendeur, ou si la revente concerne des produits qui ne sont pas de premier choix ou des produits hors production.

### B.- PRIX

**B.1.** Sauf accord contraire, les prix de vente convenus au fur et à mesure sont réputés nets, pour les paiements en espèces et les livraisons Franco l’établissement du Vendeur indiqué sur la Confirmation de Commande.

### C.- CARACTÉRISTIQUES DES PRODUITS

**C.1.** L’Acheteur déclare avoir lu et s'en tenir au contenu de la documentation suivante publiée sur le site Internet de la société: 1) Manuel de Pose, d’Utilisation, de Nettoyage et d’Entretien et 2) Fiches techniques.

**C.2.** Vu la variabilité intrinsèque du produit en céramique, les caractéristiques des échantillons et / ou des modèles envoyés précédemment par le Vendeur à l’Acheteur sont indicatifs et non contraignants.

**C.3.** Sauf en cas de demandes spécifiques à convenir avant la Confirmation de Commande, le Vendeur ne garantit pas la commande d’un article soit intégralement constituée par un même lot de production.

### D.- DÉLAIS DE LIVRAISON

**D.1.** Les délais de livraison sont indicatifs et leur éventuelle prorogation ne confère à l’Acheteur aucun droit de demander une indemnisation, sans aucune exception.

**D.2.** Si, après 14 (quatorze) jours à compter de l’avis de mise à disposition des marchandises, l’Acheteur ne retire pas le matériel, le Vendeur sera dans l’obligation, en raison de la place occupée, de ramener le matériel dans le dépôt, supportant ainsi des coûts supplémentaires ; le Vendeur se réserve la possibilité de facturer ces coûts supplémentaires à l’Acheteur.

### E.- LIVRAISON ET EXPÉDITION

**E.1.-** L'éventuelle variation de la destination des Produits, différente de celle convenue dans la Confirmation de Commande, doit être communiquée par l’Acheteur par écrit au plus tard le second jour qui précède le jour du retrait au siège du Vendeur. Le Vendeur se réserve la faculté de ne pas accepter la variation de la destination des Produits. Au cas où la destination effective du Produit serait différente de celle déclarée par l’Acheteur, le Vendeur se réserve la faculté de suspendre l’exécution des fournitures en cours et / ou de résilier le contrat sans que l’Acheteur puisse revendiquer des indemnisations directes et / ou indirectes d’aucune sorte.

**E.2.** Sauf accord contraire, la fourniture de la marchandise est livrée Départ Usine (EXW aux termes des Incoterms 2010) même si l’on a convenu que l’expédition ou

une partie de cette dernière sera suivie par le Vendeur sur mandat de l’Acheteur. En tout état de cause, les risques passent à l’Acheteur au plus tard au moment de la livraison au premier transporteur.

**E.3.** Sans préjudice du désintérêt du Vendeur par rapport au contrat de transport, celui-ci ne pourra être indiqué comme le “shipper” dans le connaissance. La communication du poids brut du container à l’expéditeur, ne constitue pas une prise de responsabilité de la part du Vendeur aux fins de la Convention SOLAS (Safety Of Life At Sea). En aucun cas cette communication ne pourra être considérée comme le VGM (Verified Gross Mass).

**E.4.** L’Acheteur s’engage à ce que le véhicule envoyé aux entrepôts du Vendeur soit compatible avec la nature des Produits à charger. Si le véhicule qui se présente comporte des difficultés significatives pour les opérations de chargement, le Vendeur se réserve la faculté de débiter une pénalité de l'ordre de 4 % de la valeur des produits pour couvrir les coûts logistiques supplémentaires. Si le véhicule convenu n'est absolument pas compatible, le Vendeur se réserve la faculté de refuser les opérations de chargement sans que l’Acheteur ne puisse rien lui demander à titre de remboursement de toute dépense directe et / ou indirecte éventuelle.

**E.5.** Il appartient à l’Acheteur de charger le transporteur de contrôler les produits avant le chargement ; d'éventuelles observations concernant l'intégrité des emballages et la correspondance des quantités chargées avec celles indiquées sur le document de transport doivent être soulevées par le transporteur au moment du chargement. Ces observations doivent être indiquées sur toutes les copies des documents de transport ; dans le cas contraire, les produits chargés sont réputés intacts et complets. Il s’ensuit que le Vendeur décline toute responsabilité en cas d’absence ou de détérioration des produits non signalée par le transporteur.

**E.6.** L’Acheteur a également la responsabilité de charger le transporteur de vérifier les modalités et la stabilité du chargement sur le véhicule afin d’éviter les bris durant le transport et le respect de toutes les dispositions de sécurité concernant la circulation sur route.

### F.- PAIEMENTS

**F.1.** Toute obligation de paiement doit être accomplie au siège légal du Vendeur. Les éventuels paiements remis à des agents, à des représentants ou à des auxiliaires de commerce ne seront réputés effectués qu’au moment où le Vendeur percevra les sommes correspondantes.

**F.2.** Il est interdit à l’Acheteur d’effectuer des paiements depuis un pays différent de son pays de résidence et ne garantissant pas un échange d’informations correct avec l’Italie. En cas de violation de cette interdiction, le Vendeur a la faculté de résilier le contrat pour juste cause sans que l’Acheteur ne puisse revendiquer le droit d’obtenir une quelconque réparation pour l’éventuel préjudice subi.

**F.3.** Les éventuels frais de timbre et d’encaissement d’effets et de traites sont à la charge de l’Acheteur. En cas de défaillance, même partielle, des intérêts de retard commencent à courir en faveur du Vendeur, à compter du jour fixé pour le paiement, dans la mesure prévue par le Décret Législatif italien n° 231 du 09/10/2002.

**F.4.** Sauf accord écrit contraire, l’Acheteur s’engage à ne compenser aucune créance échue.

### G.- RÉCLAMATIONS

**G.1.** À la réception des Produits, l’Acheteur devra soumettre ces derniers à un contrôle minutieux moyennant un examen visuel effectué conformément aux indications du point 7 des normes UNI EN ISO 10545-2.

**G.2.** L’installation et la pose des Produits doivent être effectuées en suivant scrupuleusement les recommandations inhérentes aux activités exercées avant et durant la pose indiquées sur le document 1) Manuel de Pose, d’Utilisation, de Nettoyage et d’Entretien, publié sur le site Internet du Vendeur ainsi qu’à l’extérieur et/ ou à l’intérieur de l’emballage du produit. Les défauts dus à une installation erronée et à un entretien absent / erroné (ne respectant pas les indications fournies dans le 1) Manuel de Pose, d’Utilisation, de Nettoyage et d’Entretien), par un usage prévu inapproprié et / ou par l’usure normale due au temps ne sont pas considérés comme des vices du Produit.

**G.3.** Sous réserve des limites d’acceptabilité prévues par la norme internationale EN 14411 (ISO 13006), les Parties reconnaissent comme des Vices Évidents les défauts des Produits existant dès la réception de sorte que le matériel devienne inutilisable ou qu’il perde une grande partie de sa valeur. Cette catégorie comprend les défauts définis dans le document 1) Manuel de Pose, d’Utilisation, de Nettoyage et d’Entretien publié sur le site Internet du Vendeur. À titre d’exemple non contraignant, on reconnaît comme des Vices Évidents les défauts de surface, de décoration, de polissage, de calibre, de planéité, d’orthogonalité-rectitude, d’épaisseur, les fissures,

les ébréchés, les hors nuance, les nuances mélangées et les Produits qui présentent des problèmes de coupe - voile.

**G.4.** Si l’Acheteur relève des Vices Évidents, il devra présenter une réclamation écrite au Vendeur, sous peine de déchéance, dans un délai de 8 (huit) jours à compter de la réception et tenir le lot complet de matériel à la disposition de ce dernier. La réclamation devra indiquer les données de facturation et une description précise du vice objet de la réclamation, accompagnée, si possible, de photographies. Si la réclamation devait s’avérer sans fondement, l’Acheteur est disposé à rembourser au Vendeur les dépenses encourues pour l’éventuelle visite des lieux (expertises, déplacements, etc.).

**G.5.** Les Vices Cachés devront être notifiés au Vendeur par lettre recommandée avec avis de réception, sous peine d’annulation de la garantie, dans un délai de 8 (huit) jours à compter de la date de la découverte du défaut.

**G.6.** L’action de l’Acheteur ayant pour but de faire valoir la garantie en cas de vices se prescrit dans un délai de 12 (douze) mois à compter de la livraison des Produits.

### H.- GARANTIE COUVRANT LES VICES

**H.1.** La garantie du Vendeur est réputée limitée aux seuls Produits de premier choix et non aux Produits de second ou de troisième choix ou à des lots d’occasion auquel on applique des prix ou des remises particuliers lorsqu'ils sont dûment signalés dans les notes de la Confirmation de Commande.

**H.2.** Le Vendeur ne garantit pas l’adéquation des Produits à des usages particuliers, mais uniquement les caractéristiques techniques publiées sur le site Internet dans le document 2) Fiches techniques. L’usage indiqué, également lorsqu’il est présenté par le Vendeur dans des catalogues et des manuels, est purement indicatif. Sur la base des caractéristiques techniques indiquées dans les 2) Fiches Techniques, le concepteur a toujours le devoir d’évaluer l’adéquation du Produit aux conditions spécifiques d’utilisation en fonction des contraintes et des variables pouvant se vérifier dans le lieu de destination et susceptibles d’en altérer les caractéristiques, par exemple, l’intensité et la qualité de la circulation (piétinement en présence de sable, de détritux...), ainsi que les éventuelles conditions climatiques défavorables et toute autre incidence à laquelle peut être exposé le matériel.

**H.3.** Si l’on a constaté que le Produit présente les Vices Évidents définis à la lettre G n°3, le Vendeur remplacera le Produit défectueux par un autre produit ayant des caractéristiques analogues ou supérieures ou, lorsque cela est impossible, à une réduction cohérente du prix. En alternative, l’Acheteur aura droit, après la restitution des Produits défectueux, au remboursement du prix payé, majoré du prix du transport, à l’exclusion du remboursement de tout autre préjudice direct et / ou indirect.

**H.4.** La garantie du Vendeur doit être réputée exclue au cas où le Produit présentant des Vices Évidents (entièrement ou partiellement) aurait été utilisé et / ou du moins transformé ; dans ce cas, on considèrera que l’Acheteur (ou son client) a exprimé la volonté de les accepter en l'état.

**H.5.** Si l’on a constaté que le Produit présente des Vices Cachés, la garantie du Vendeur se limite au remplacement du matériel par du matériel ayant des caractéristiques analogues ou supérieures et, lorsque cela est impossible, au remboursement du prix payé majoré des frais de transport. En tout état de cause, la garantie du Vendeur couvrant tout dommage direct et / ou indirect causé par le produit défectueux, se limitera à une somme qui ne pourra pas dépasser le double du prix de vente appliqué par le Vendeur dans le cadre de la seule partie de la fourniture défectueuse.

**H.6.** Si l’Acheteur revend le Produit à des clients protégés par le code de la consommation (Décret-loi italien n° 206/2005) il sera responsable des conditions appliquées si celles-ci diffèrent des conditions indiquées ici et il devra s’assurer que les droits du consommateur sont exercés dans le respect des remèdes et des délais fixés par ce code. Si les conditions sont réunies, le droit de retrait et / ou de recours revenant à l’Acheteur à l'encontre du Vendeur / fabricant ne pourra dépasser ni les exonérations ni les limites établies de la lettre G n°1 à la lettre H n°5.

### I. CLAUSES SOLVE ET REPETE ET CLAUSES RÉSOLUTOIRES

**I.1.** Aux termes de l’art. 1462 du Code Civil italien, en aucun cas, y compris les prétendus vices ou défauts du matériel, l’Acheteur ne pourra suspendre ou retarder le paiement du matériel retiré, sans préjudice naturellement de la faculté d’exiger lorsqu'il est en mesure de démontrer avoir indûment payé.

**I.1.** En cas de variation des conditions patrimoniales de l’Acheteur ou de non-paiement même partiel de produits déjà fournis, le Vendeur se réserve la faculté de suspendre l’exécution des fournitures en cours et / ou de résilier les contrats sans que l’Acheteur ne puisse revendiquer des indemnisations directes et / ou indirectes d’aucune sorte.

RÉV. 3 DU 1ER SEPTEMBRE 2020

## INDEX



## PRODUCT FINDER



## SURFACE RANGE



## COMPANY



## COLLECTIONS



## LARGE SIZES



## TECHNICAL SPECIFICATIONS





## ALLGEMEINE VERKAUFSBEDINGUNGEN

### A.- MODALITÄT DES VERTRAGSABSCHLUSSES

**A.1.** Die vorliegenden Allgemeinen Verkaufsbedingungen regeln alle Verträge zwischen dem Verkäufer und dem Käufer und alle Änderungen oder Abweichungen davon müssen schriftlich vereinbart werden.

**A.2.** Eventuelle Angebote sowie mit Handelsvertretern oder sonstigen Vermittlern vereinbarten Gutschriften sind nicht verbindlich, es sei denn, sie werden vom Verkäufer schriftlich bestätigt.

**A.3.** Der Käufer sendet dem Verkäufer direkt oder über Handelsvertreter schriftliche Bestellungen zu, die die Angabe der Artikelnummern der gewünschten Produkte, der Mengen, ihres Preises und der Bestimmung enthalten müssen. Die vom Käufer gesendete Bestellung ist unwiderruflich.

**A.4.** Der Verkauf gilt zu dem Zeitpunkt als abgeschlossen, an dem: (i) der Käufer vom Verkäufer eine schriftliche Bestätigung per E-Mail, Fax oder auf sonstigem Weg erhält, die den Fristen und Bedingungen der Bestellung entspricht; oder (ii) falls die vom Verkäufer gesendete Bestätigung, Bedingungen enthält, die von der vom Käufer erhaltenen Bestellung abweichen, wenn dieser diese akzeptiert oder nicht innerhalb von 7 (sieben) Tagen ab ihrem Empfang beanstandet; oder (iii) falls keine schriftliche Bestätigung durch den Verkäufer erfolgt, zu dem Zeitpunkt, an dem die Produkte geliefert und vom Käufer übernommen werden.

**A.5.** Der Käufer teilt die Notwendigkeit, das nationale Gebiet für die Verkäufe der Produkte von Atlas Concorde zu unterteilen. Der Verkäufer hält diese Regel für ein unverzichtbares Element, um es ihm zu gestatten, seine kommerzielle Politik zu koordinieren und sein Vertriebsnetz mit Angeboten für die Erfordernisse der einzelnen Länder zu rationalisieren. Außerdem erkennt der Käufer an, dass diese Notwendigkeit auch zum Schutz der eigenen Interessen dient. Der Käufer verpflichtet sich daher, die von Ceramiche Atlas Concorde SpA gelieferten Produkte ausschließlich in dem Land zu vertreiben, in dem er seinen Firmensitz hat, und den aktiven Verkauf – auch online – an Kunden mit Sitz in einem anderen Staat zu unterlassen. Für Dreiecksgeschäfte wird die vorliegende Pflicht auf das Land angewendet, in dem der Käufer effektiv tätig ist.

Der Käufer kann das Produkt außerhalb seines eigenen Gebiets verkaufen, falls er die schriftliche Genehmigung des Verkäufers einholt, oder falls der Verkauf nicht Produkte erster Wahl oder Produkte außerhalb der Produktion betrifft.

### B.- PREISE

**B.1.** Vorbehaltlich abweichender schriftlicher Vereinbarungen gelten die von Mal zu Mal vereinbarten Verkaufspreise als Nettobarpreise bar mit Lieferung frei ab dem in der Auftragsbestätigung angegebenen Werk des Verkäufers.

### C.- EIGENSCHAFTEN DER PRODUKTE

**C.1.** Der Käufer erklärt, die folgende auf der Web-Site des Unternehmen veröffentlichte Dokumentation zu Kenntnis genommen zu haben und sich an deren Inhalt zu halten: 1) Handbuch zur Verlegung, Benutzung, Reinigung und Pflege, und 2) Technische Datenblätter.

**C.2.** Aufgrund der intrinsischen Variabilität des Keramikprodukts sind die Eigenschaften der vorausgehend vom Verkäufer an den Käufer gesendeten Warenmuster und/oder Modelle hinweisend und unverbindlich.

**C.3.** Vorbehaltlich spezifischer Vereinbarungen vor der Auftragsbestätigung garantiert der Verkäufer nicht, dass die Lieferung des einzelnen Artikels vollständig mit dem gleichen Produktionslos ausgeführt wird.

### D.- LIEFERFRISTEN

**D.1.** Die Lieferbedingungen sind richtungweisend; durch eine eventuelle Verlängerung entsteht für den Käufer ausnahmslos kein Recht auf Schadenersatz.

**D.2.** Wenn der Käufer das Material nicht innerhalb von 14 (vierzehn) Tagen ab der Mitteilung der Bereitstellung der Ware abholt, ist der Verkäufer aus Platzgründen gezwungen, das Material an die Lagerorte zurückzubringen, wodurch zusätzliche Kosten entstehen; der Verkäufer behält sich das Recht vor, dem Käufer diese zusätzlichen Kosten in Rechnung zu stellen.

### E.- RÜCKLIEFERUNG UND VERSAND

**E.1.** Die eventuelle Änderung des Bestimmungsortes der Produkte, die sich von der in der Auftragsbestätigung vereinbarten unterscheidet, muss vom Käufer schriftlich innerhalb des zweiten Tags vor dem für die Abholung am Sitz des Verkäufers vorgesehenen mitgeteilt werden. Der Verkäufer behält sich das Recht vor, die Änderung der Bestimmung der Produkte nicht zu akzeptieren. Falls sich herausstellt, dass die effektive Bestimmung des Produkts von der vom Käufer angegebenen verschieden ist, behält sich der Verkäufer das Recht vor, die laufenden Lieferungen nicht auszuführen und/oder die laufenden Verträge aufzulösen, ohne dass der Käufer jeglichen Anspruch auf Entschädigung geltend machen kann.

**E.2.** Vorbehaltlich abweichender Vereinbarungen erfolgt die Lieferung der Ware frei ab Werk (EXW gemäß den Incoterms 2010), und dies auch, falls vereinbart wird, dass der Versand oder ein Teil desselben im Auftrag des Käufers durch den Verkäufer erfolgt. In jedem Fall gehen die Risiken spätestens mit der Übergabe an das erste Transportunternehmen an den Käufer über.

**E.3.** Unter Beibehaltung der Nichtbeteiligung des Verkäufers am Transportvertrag kann der Verkäufer in der Police der Ladung als „Shipper“ angegeben werden. Die Mitteilung des Bruttogewichts des Containers an den Transportunternehmer stellt keine Übernahme der Verantwortung des Verkäufers hinsichtlich der SOLAS-Konvention dar (Safety Of Life At Sea). In keinem Fall kann diese Mitteilung als VGM (Verified Gross Mass) verstanden werden.

**E.4.** Der Käufer verpflichtet sich sicherzustellen, dass das zu den Lagern des Verkäufers gesendete Fahrzeug unter Berücksichtigung der Natur der Produkte für das Laden geeignet ist. Falls das zum Laden gesendete Fahrzeug größere Probleme beim Beladen bereitet, behält der Verkäufer sich das Recht vor, zur Abdeckung der höheren Logistikkosten eine Vertragsstrafe in Höhe von 4 % des Werts der Produkte zu erheben. Falls das Fahrzeug vollkommen ungeeignet ist, behält sich der Verkäufer das Recht vor, das Verladen zu verweigern, ohne dass der Käufer einen Anspruch auf Vergütung der Schäden geltend machen kann, die direkt und/oder indirekt daraus entstehen können.

**E.5.** Es ist Aufgabe des Käufers, das Transportunternehmen zu beauftragen und die Produkte vor dem Laden zu kontrollieren; eventuelle Anmerkungen zur Unversehrtheit der Verpackungen und der Übereinstimmung der geladenen Menge mit der in den Transportpapieren angegebenen müssen vom Transportunternehmen zum Zeitpunkt des Ladens vorgenommen werden. Diese Anmerkungen müssen auf alle Exemplaren der Transportpapiere vermerkt werden, anderenfalls gelten die geladenen Produkte als unbeschädigt und vollständig. Daraus folgt, dass der Verkäufer keinerlei Haftung für Fehlmengen oder Beschädigungen der Produkte übernimmt, die vom Transportunternehmen nicht gemeldet werden.

**E.6.** Es ist ebenfalls Aufgabe des Käufers, das Transportunternehmen zu beauftragen und die Modalität und die Stabilität des Ladens auf das Fahrzeug zu überprüfen, damit es während des Transports nicht zu Brüchen kommt, sowie die Einhaltung der Sicherheitsbestimmungen der Straßenverkehrsordnung zu gewährleisten.

### F.- ZAHLUNGEN

**F.1.** Alle Zahlungsverpflichtung müssen am Firmensitz des Verkäufers erfüllt werden. Eventuelle Zahlungen an Handelsvertreter oder Außendienstmitarbeiter gelten als nicht geleistet, bis sie beim Verkäufer eingehen.

**F.2.** Es ist dem Käufer untersagt, die Zahlungen aus Ländern vorzunehmen, die vom Land seines Firmensitzes verschieden sind, falls diese Länder keinen angemessenen Informationsaustausch mit Italien gewährleisten. Im Fall der Verletzung dieses Verbots hat der Verkäufer das Recht, den Vertrag aus gutem Grund aufzulösen, ohne dass der Käufer eine Vergütung des entstandenen Schadens geltend machen kann.

**F.3.** Eventuelle Kosten und Gebühren für die Einziehung von Effekten und Wechseln gehen zu Lasten des Käufers. Im Fall der Nichteinhaltung des für die Zahlung festgesetzten Tags – auch nur partiell – fallen Säumniszinsen zu Gunsten des Verkäufers an, in der vom ital. Gesetzerlass vom 9. Oktober 2002, Nr. 231 vorgesehenen Höhe.

**F.4.** Vorbehaltlich abweichender schriftlicher Vereinbarungen verpflichtet sich der Käufer, keine Guthaben gegenüber dem Verkäufer zu verrechnen.

### G.- BEANSTANDUNGEN

**G.1.** Beim Empfang der Produkte muss der Käufer sie einer sorgfältigen Sichtkontrolle gemäß den Angaben von Punkt 7 der Normen UNI EN ISO 10545-2 unterziehen.

**G.2.** Die Installation und die Verlegung der Produkte müssen unter Einhaltung der Empfehlungen zu den Arbeiten ausgeführt werden, die vor und während der Verlegung ausgeführt werden müssen, wie angegeben im Dokument 1) Handbuch zur Verlegung, Verwendung, Reinigung und Pflege, veröffentlicht auf der Web-Site des Verkäufers und angegeben auf der Verpackung des Produkts und/oder im Inneren derselben. Schäden, die durch eine falsche Installation, Verlegung und durch eine unterlassene/falsche Pflege (abweichend von den Angaben in 1) Handbuch zur Verlegung, Reinigung und Wartung), durch eine ungeeignete Gebrauchsbestimmung oder durch normale Abnutzung verursacht werden, werden nicht als Mängel des Produkts anerkannt.

**G.3.** Vorbehaltlich der Grenzen der Akzeptabilität, die von der internationalen Norm EN 14411 (ISO 13006) vorgesehen sind, erkennen die Parteien Mängel der Produkte als offensichtliche Mängel an, die bereits bei ihrem Empfang festgestellt werden können, die das Material zur Verwendung ungeeignet machen oder die den Wert beträchtlich verringern. In diese Kategorie fallen Mängel, wie im

Dokument definiert 1) Handbuch zur Verlegung, Benutzung, Reinigung und Pflege, veröffentlicht auf der Web-Site des Verkäufers. Als nicht erschöpfende Beispiele werden Oberflächenmängel, fehlerhafte Grafik, Defekte polierte Oberfläche, Defekte des Kalibers, der Planarität, der Rechtwinkligkeit/Gradlinigkeit, der Stärke, Risse, abgeschlagene Kanten, Fehlfarbe, gemischte Brandfarbe sowie Produkte mit Kantsplitterung durch Rettifizierung als offensichtliche Mängel anerkannt.

**G.4.** Falls der Käufer offensichtliche Mängel feststellt, muss er dies dem Verkäufer innerhalb von 8 (acht) Tagen ab dem Empfang schriftlich melden und die gesamte Charge des Materials für den Verkäufer zur Verfügung halten; anderenfalls verfällt der Rechtsanspruch. Bei der Beanstandung müssen die Daten der Rechnung sowie eine präzise Beschreibung des beanstandeten Mangels angegeben werden, falls möglich mit einer fotografischen Dokumentation. Falls die Beanstandung unberechtigt sein sollte, ist der Käufer gehalten, dem Verkäufer die für einen eventuellen Ortstermin aufgewendeten Kosten (Gutachten, Reisekosten, usw.) zu erstatten.

**G.5.** Versteckte Mängel müssen dem Verkäufer innerhalb von 8 (acht) Tagen ab Feststellung des Mangels per Einschreiben mit Rückschein gemeldet werden; anderenfalls verfällt der Rechtsanspruch.

**G.6.** Die Aktion des Käufers zur Inanspruchnahme der Mängelhaftung muss in jedem Fall innerhalb von 12 (zwölf) Monaten ab der Lieferung der Produkte erfolgen.

### H.- MÄNGELHAFTUNG

**H.1.** Die Garantie des Verkäufers ist begrenzt auf Produkte erster Qualität und sie bezieht sich nicht auf Produkte zweiter oder dritter Qualität oder auf gelegentliche Partien mit besonderen Preisen oder Nachlässe, die in der Auftragsbestätigung angegeben werden.

**H.2.** Der Verkäufer garantiert nicht die Eignung der Produkte für besondere Verwendungen, sondern lediglich die technischen Eigenschaften, die auf der Web-Site in Dokument 2) Technische Datenblätter veröffentlicht sind. Die Angabe zur Verwendung ist als unverbindlich anzusehen, auch wenn vom Verkäufer in Katalogen und Handbüchern angegeben ist. Es ist stets Aufgabe des Planers, auf der Grundlage der in den 2) Technischen Datenblättern angegebenen Eigenschaften die Eignung des Produkts für spezifische Nutzungsbedingungen zu bewerten, unter Berücksichtigung der Belastungen sowie der Variablen, die am Ort der Bestimmung auftreten und die Eigenschaften verändern können, wie zum Beispiel die Intensität des Verkehrs, die Qualität des Verkehrs (Begehung bei Vorhandensein von Sand, Schmutz usw.), die eventuellen klimatischen Bedingungen sowie alle sonstigen Einflüsse, denen das Material ausgesetzt sein kann.

**H.3.** Falls festgestellt wird, dass das Produkt offensichtliche Mängel aufweist, wie definiert in Punkt G, Nr. 3, nimmt der Verkäufer die Ersetzung des mangelhaften Produkts durch ein anderes mit gleichen oder höherwertigen Eigenschaften vor, oder er nimmt eine angemessene Reduzierung des Preises vor, falls dies nicht möglich ist. Alternativ hat der Käufer nach Rücklieferung der mangelhaften Produkte das Recht auf Rückerstattung des bezahlten Preises, zuzüglich der Transportkosten, mit Ausschließung der Vergütung aller direkten und/oder indirekten Schäden.

**H.4.** Die Garantie des Verkäufer wird ausgeschlossen, falls das mangelhafte Produkt (ganz oder teilweise) verwendet und/oder umgewandelt worden ist, da davon ausgegangen wird, dass der Käufer (oder sein Kunde) dadurch seinen Willen zum Ausdruck gebracht hat, es in dem Zustand zu akzeptieren, in dem es sich befindet.

**H.5.** Falls festgestellt wird, dass das Produkt versteckte Mängel aufweist, ist die Garantie des Verkäufers auf die Ersetzung des Materials durch anderes mit gleichen oder höherwertigeren Eigenschaften beschränkt oder – falls dies nicht möglich ist – auf die Rückerstattung des bezahlten Preises, zuzüglich der Transportkosten. In jedem Fall ist die Garantie des Verkäufers für alle direkten und/oder indirekten Schäden, die durch das mangelhafte Produkt entstehen, auf einen Betrag begrenzt, der das Doppelte des Verkaufspreises nicht übersteigen kann, den der Verkäufer auf den mangelhaften Teil der Lieferung angewendet hat.

**H.6.** Falls der Käufer das Produkt an Kunden weiterverkauft, die vom Verbraucherschutzgesetz (ital. Gesetzerlass Nr. 206/2005) geschützt werden, ist er verantwortlich für die angewendeten Bedingungen, falls diese von den hier angegebenen abweichen, und er muss sicherstellen, dass die Rechte des Verbrauchers gemäß den Bestimmungen dieses Gesetzes ausgeübt werden können. Falls die Voraussetzungen gegeben sind, kann das Regressrecht des Käufers gegenüber dem Verkäufer/Hersteller nicht die Grenzen übersteigen, die von Punkt G, Nr. 1 bis Punkt H, Nr. 5 angegeben werden.

### I. KLAUSEL SOLVE ET REPETE UND AUFLÖSUNGSKLAUSEL

**I.1.** Gemäß den Bestimmungen von § 1462 des ital. Bürgerlichen Gesetzbuches kann der Käufer in keinem Fall – einschließlich von vermeintlichen Mängeln oder Defekten des Materials – die Zahlung des abgenommenen Materials aussetzen

## FASSUNG 3 VOM 1 SEPTEMBER 2020

oder verzögern, natürlich vorbehaltlich des Rechts, ungerechtfertigt gezahlte Beträge zurückzufordern, und dies nur nach Erbringung des Nachweises der Rechtmäßigkeit der Forderung (Solve et Repete).

**I.2.** Im Fall der Veränderung der Vermögensbedingungen des Käufers oder der auch nur partiellen Nichtbezahlung der bereits gelieferten Produkte kann der Verkäufer die laufenden Lieferungen aussetzen und/oder die laufenden Verträge auflösen, ohne dass der Käufer die Vergütung von direkten und/oder indirekten Schäden geltend machen kann.

### L.- EIGENTUMSVORBEHALT

**L.1.** Bis zur vollständigen Bezahlung des Preises durch den Käufer bleiben die Produkte, die den Gegenstand der Lieferung darstellen, Eigentum des Verkäufers. **L.2.** Während dieses Zeitraums übernimmt der Käufer die Pflichten und die Verantwortlichkeiten für die Aufbewahrung der gekauften Produkte und er kann sie nicht veräußern, zur Nutzung überlassen oder beschlagnahmen oder pfänden lassen, ohne das Eigentum des Verkäufers anzugeben und ohne diesen umgehend per Einschreiben mit Rückschein zu benachrichtigen.

### M.- HÖHERE GEWALT

**M.1.** Beide Parteien können die Ausführung der vertraglichen Pflichten aussetzen, wenn die Ausführung aus Gründen, die vom eigenen Willen unabhängig sind, unmöglich oder objektiv zu aufwendig wird, wie zum Beispiel: Streiks, Boykott, Aussperrung, Brand, Krieg (erklärt oder nicht), Bürgerkrieg, Aufstände und Revolutionen, Beschlagnahme, Embargo, Unterbrechungen der Energieversorgung, außerordentliche Defekte von Maschinen, Verspätung bei der Anlieferung von Komponenten und Rohstoffen.

**M.2.** Die Partei, die beabsichtigt, die vorliegende Klausel in Anspruch zu nehmen, muss der anderen Partei schriftlich das Auftreten von Umständen der Höheren Gewalt mitteilen.

**M.3.** Falls die Aussetzung aufgrund von Höherer Gewalt mehr als 60 (sechzig) Tage andauert, haben beiden Parteien das Recht, den vorliegenden Vertrag nach einer schriftlichen Vorankündigung von 10 (zehn) Tagen an die Gegenpartei aufzulösen.

### N.- VERTRAULICHKEITSPFLICHT

**N.1.** Der Käufer ist gehalten, über alle technischen Informationen (wie zum Beispiel Zeichnungen, Prospekte, Dokumentationen, Formeln und Schriftverkehr) und kommerziellen Informationen (einschließlich der Vertragsbedingungen, der Kaufpreise, der Zahlungsbedingungen usw.), in deren Kenntnis während der Ausführung des vorliegenden Vertrages kommt, absolute Vertraulichkeit einzuhalten. **N.2.** Die Vertraulichkeitspflicht wird für die Dauer des Vertrages sowie den Zeitraum nach seiner Ausführung übernommen.

**N.3.** Im Fall der Nichteinhaltung der Vertraulichkeitspflicht ist die nicht einhaltende Partei gehalten, der anderen Partei alle daraus entstehenden Schäden zu vergüten.

### O.- MARKEN UND KENNZEICHNUNGEN DES VERKÄUFERS

**O.1.** Die Verwendung von Marken, Ziermotiven und geistigem Eigentum im Allgemeinen in jeder Form sowie jeder Ausdrucksform (als nicht erschöpfendes Beispiel: Bilder, Fotos, Zeichnungen, Filme, Abbildungen, Strukturen usw.), die intellektuelles Eigentum des Verkäufers sind, ist auf jede Weise (als nicht erschöpfendes Beispiel: Presse, Video, Radio, Internet, Social Media, Instant-Message-Plattform oder VoIP usw.) strengstens untersagt. Alle – auch nur partielle – Abweichungen von diesem Verbot müssen von Fall zu Fall schriftlich von der Generaldirektion des Verkäufers autorisiert werden.

### P.- SPRACHE DES VERTRAGS, ANWENDBARES RECHT, RECHTSPRECHUNG UND GERICHTSSTAND

**P.1.** Der Vertrag und die vorliegenden Bedingungen werden in italienischer Sprache verfasst, die im Fall der Abweichung der Übersetzung in andere Sprachen Vorrang hat.

**P.2.** Die Regelung aller Rechtssachen hinsichtlich den Lieferungen unterliegt der Rechtsprechung des italienischen Staats und die territoriale Zuständigkeit liegt ausschließlich beim Bezirksgericht Modena, dem Ort des Firmensitzes des Verkäufers.

Weitere Informationen entnehmen Sie bitte den Allgemeinen Geschäftsbedingungen, die unter der Adresse [www.atlasconcorde.com](http://www.atlasconcorde.com) zur Verfügung stehen.

## INDEX



## PRODUCT FINDER



## SURFACE RANGE



## COMPANY



## COLLECTIONS



## LARGE SIZES



## TECHNICAL SPECIFICATIONS



## CONDICIONES GENERALES DE VENTA

### A.- MODALIDADES DE CELEBRACIÓN DEL CONTRATO

**A.1.** Las presentes Condiciones Generales de Venta disciplinan todo contrato de venta entre el Vendedor y el Comprador y toda modificación o cancelación debe ser establecida por escrito.

**A.2.** Eventuales ofertas, acreditaciones y/o descuentos otorgados por agentes u otros intermediarios, no son considerados válidos mientras no sean confirmados por escrito por el Vendedor.

**A.3.** El Comprador envía al Vendedor, directamente o a través de agentes, pedidos por escrito que deben contener la indicación de los códigos de los productos requeridos, de las cantidades, de sus precios y de su destino. El pedido enviado por el Comprador es irrevocable.

**A.4.** La venta deberá considerarse perfeccionada desde el momento en que: (a) el Comprador recibe por parte del Vendedor una confirmación –escrita a través de e-mail, fax u otros medios telemáticos– conforme con los términos y según las condiciones del pedido; o (b) en caso de confirmación enviada por el Vendedor que contenga condiciones diferentes de las del pedido enviado por el Comprador cuando este las acepte por escrito o, en todo caso, no las cuestione dentro de los 7 (siete) días sucesivos a la recepción; o (c) en ausencia de confirmación escrita por el Vendedor, en el momento en que los productos serán entregados y serán cargados por el Comprador.

**A.5.** El Comprador comprende y acepta la necesidad de limitar al territorio nacional las ventas de los productos Atlas Concorde. El Vendedor estima que esta norma constituye un factor indispensable para poder coordinar su política comercial y racionalizar la red de distribución, con ofertas más orientadas a los requerimientos de cada país. De igual modo, el Comprador reconoce que este requerimiento constituye también salvaguardia de sus propios intereses. Por lo tanto, el Comprador se obliga a comercializar los productos suministrados por Ceramiche Atlas Concorde SpA exclusivamente en su país de residencia, absteniéndose de promover ventas activas, solicitadas incluso online, respecto a clientes domiciliados en el territorio de cualquier otro país que no sea el propio. Para operaciones triangulares esta obligación se aplica al país de operatividad efectiva del Comprador.

El Comprador podrá revender el producto fuera de su propio territorio en caso de recibir autorización por escrito por parte del Vendedor o en caso de que la reventa se refiera a productos que no sean de primera selección o que estén fuera de producción.

### B.- PRECIOS

**B.1.** Salvo acuerdo escrito en contrario, los precios de venta acordados de manera puntual se entienden al neto en efectivo y para entrega en el establecimiento del Vendedor indicado en la confirmación del pedido.

### C.- CARACTERÍSTICAS DE LOS PRODUCTOS

**C.1.** El Comprador declara haber visto y atenerse al contenido de la siguiente documentación publicada en el sitio internet de la empresa: 1) Manual de Colocación, Uso, Limpieza y Mantenimiento y 2) Fichas Técnicas.

**C.2.** Dada la intrínseca variabilidad del producto cerámico, las características de las muestras y/o modelos enviados anteriormente por el Vendedor al Comprador deben ser considerados como aproximados y no vinculantes.

**C.3.** Salvo especificaciones requeridas, a acordar antes de la confirmación del pedido, el Vendedor no garantiza que el pedido de un artículo en particular sea despachado como un mismo lote de producción.

### D.- PLAZOS DE ENTREGA

**D.1.** Los plazos de entrega son orientativos y su demora no conlleva derecho alguno a solicitar indemnización alguna por parte del comprador, sin excepciones.

**D.2.** Si el comprador no recogiera el material transcurridos 14 (catorce) días desde la fecha del aviso de estar lista la mercancía, por necesidad de espacio el vendedor se verá obligado a devolver dicho material al almacén, lo que conlleva unos costes añadidos reservándose el mismo la facultad de cargarlos al comprador.

### E.- ENTREGA Y TRANSPORTE

**E.1.** La eventual variación de lugar de destino de los productos, señalando uno diferente respecto de aquel acordado en la confirmación de pedido, debe ser comunicada por el Comprador por escrito dentro del plazo máximo taxativo del penúltimo día previo al retiro desde el establecimiento del Vendedor. El Vendedor se reserva la facultad de no aceptar el cambio de lugar de destino de los Productos. En caso de verificarse que el destino efectivo del producto sea diferente de aquel declarado por el Comprador, el Vendedor se reserva la facultad de suspender la realización de los suministros en curso y/o de rescindir los contratos

en curso sin que el Comprador pueda pedir resarcimientos directos y /o indirectos de ningún tipo.

**E.2.** Salvo acuerdo en contrario, el suministro de la mercancía se entiende ex Works (EXW según Incoterms 2010) y ello también cuando se acuerde que el transporte o parte de él quede a cargo del Vendedor, según mandato del Comprador. En todo caso, los riesgos se transfieren al Comprador a más tardar con la entrega al primer transportador.

**E.3.** Como confirmación del hecho de que el Vendedor es ajeno al contrato de transporte, el mismo no podrá ser indicado como “shipper” en la póliza de carga. La comunicación del peso bruto del contenedor al transportista no comporta ninguna asunción de responsabilidad de parte del Vendedor para los fines del Convenio SOLAS (Safety Of Life At Sea). De ninguna manera la antedicha comunicación podrá ser considerada como VGM (Verified Gross Mass).

**E.4.** El Comprador se compromete a fin de que el vehículo enviado al establecimiento del Vendedor sea idóneo para cargar considerando la naturaleza de los productos. En caso de que el vehículo que se presenta comporte significativas dificultades para las operaciones de carga, el Vendedor se reserva el derecho a incluir una recarga del 4 % del valor de los productos a cobertura de los mayores costos logísticos. Si el vehículo enviado para retirar la mercancía no es absolutamente idóneo, el Vendedor se reserva la facultad de negar las operaciones de carga sin que nada pueda requerir el Comprador a título de resarcimiento por todo eventual costo directo y/o indirecto que de ello pueda derivar.

**E.5.** Es tarea del Comprador encargar al transportista controlar los productos antes de cargarlos; eventuales observaciones sobre la integridad de los embalajes y la exactitud de las cantidades cargadas, así como aquellas puestas en el documento de transporte, deben ser presentadas por el transportista en el momento de cargar. Estas observaciones deben ser reproducidas en todas las copias de los documentos de transporte; de lo contrario los productos cargados se entienden íntegros y completos. De ello deriva que el Vendedor no se asume ninguna responsabilidad con referencia a faltas o daños en los productos no señalados por el transportista.

**E.6.** Asimismo, es responsabilidad del Comprador encargar al transportista verificar las modalidades y la estabilidad de la carga sobre el vehículo a fin de que durante el transporte no se produzcan roturas y que sean respetadas todas las disposiciones sobre seguridad relativas a la circulación por vías públicas.

### F.- PAGOS

**F.1.** Toda obligación de pago debe ser cumplida en la sede legal del Vendedor. Eventuales pagos a agentes, representantes o auxiliares de comercio no se entienden efectuadas mientras las respectivas sumas no lleguen a poder del Vendedor.

**F.2.** Queda prohibido para el Comprador cumplir su propia obligación mediante pagos provenientes de países que no sean su propio país de residencia si se trata de países que no garantizan adecuado intercambio de informaciones con Italia. En caso de violación de esta prohibición, el Vendedor tiene facultad de rescindir el contrato por justa causa sin que el Comprador pueda pretender derecho de obtener algún resarcimiento por eventual daño sufrido.

**F.3.** Eventuales gastos de sello fiscal y de cobro de letras de cambio y efectos comerciales quedan a cargo del Comprador. En caso de incumplimiento, incluso solo parcial, del día fijado para el pago, se devengarán a favor del Vendedor los intereses de mora en la medida prevista por el Decreto Leg. n. 231 del 09/10/2002.

**F.4.** Salvo acuerdos escritos que lo contradigan, el Comprador se compromete a no compensar ningún crédito de cualquier forma creado respecto del Vendedor.

### G.- RECLAMOS

**G.1.** Al recibir los productos, el Comprador deberá someterlos a cuidadoso control a través de un examen visual efectuado conforme según las indicaciones del punto 7.4 de las normas UNI EN ISO 10545-2.

**G.2.** La instalación y colocación de los productos deberá efectuarse respetando escrupulosamente las recomendaciones inherentes a las actividades a realizar antes y durante la colocación, indicadas en el documento 1) Manual de Colocación, Uso, Limpieza y Mantenimiento publicado en el sitio internet del Vendedor y en el embalaje del producto y/o en el interior del mismo. No son considerados como vicios del producto aquellos generados por una errónea instalación y *error/falta* de mantenimiento (intervenciones diferentes de las instrucciones proporcionadas en el 1) Manual de Colocación, Uso, Limpieza y Mantenimiento), por un uso inapropiado y/o por el normal desgaste con el pasar del tiempo.

**G.3.** Sin perjuicio de los límites de aceptabilidad previstos por la norma internacional EN 14411 (ISO 13006), las partes reconocen como vicios evidentes los defectos de

los productos constatables ya en el momento de su recepción y tales que impidan el uso previsto del material o reduzcan de modo apreciable su valor. Forman parte de esta categoría los defectos precisamente establecidos en el documento 1) Manual de Colocación, Limpieza y Mantenimiento publicado en el sitio internet del Vendedor. A título solo de ejemplo, se reconocen como vicios evidentes los defectos superficiales, los defectos de decoración, de lapeado/pulido, de calibre, de planitud, de ortogonalidad-rectilineidad, de espesor, las grietas, los astillados, las variaciones de tono, los tonos mezclados y los productos que presentan problemas de cortes/escamas.

**G.4.** En caso de que el Comprador observe la presencia de vicios evidentes, deberá presentar reclamo al Vendedor por escrito, so pena de extinción del derecho, dentro de los 8 (ocho) días sucesivos a la recepción y mantener a disposición del Vendedor la partida completa de material. El reclamo deberá indicar los datos de facturación y una precisa descripción del vicio observado incluyendo, en lo posible, imágenes fotográficas. En caso de que el reclamo debiera demostrarse luego ser infundado, el Comprador se declara dispuesto a resarcir al Vendedor por los gastos efectuados para realizar la respectiva constatación in situ (peritajes, viajes, etc.).

**G.5.** Los vicios ocultos deberán ser notificados al Vendedor mediante carta certificada con aviso de recibo, bajo pena de caducidad de la garantía, dentro de los 8 (ocho) días a contar de la fecha del descubrimiento del defecto.

**G.6.** La acción del Comprador tendiente a hacer valer la garantía por vicios prescribe, en todo caso, en el plazo de 12 (doce) meses a contar de la entrega de los productos.

### H.- GARANTÍA POR VICIOS

**H.1.** La garantía del Vendedor se entiende limitada solo a los productos de primera selección y no a los productos de segunda o tercera selección o de partidas de ocasión con precios o descuentos especiales cuando ello se encuentra debidamente señalados en nota en la confirmación del pedido.

**H.2.** El Vendedor no garantiza la idoneidad de los productos para usos particulares, sino solo las características técnicas publicadas en el sitio internet, documento 2) Fichas Técnicas. La indicación de uso, incluso cuando es presentada por el Vendedor en catálogos y manuales, debe considerarse solo como genérica. Sobre la base de las características técnicas señaladas en las 2) Fichas Técnicas, es siempre tarea del proyectista evaluar la idoneidad del producto en función de las condiciones específicas de uso en consideración de las solicitudes y de las variables que pueden operar en el ambiente de destino, alterando sus características; a título de ejemplo: la intensidad del tráfico, la calidad del tráfico (tránsito en presencia de arena, de detritos, etc.), las eventuales condiciones climáticas adversas y cualquier otro factor aleatorio al que puede quedar expuesto el material.

**H.3.** En caso de comprobarse que el producto manifieste vicios evidentes, tal como han sido definidos en la letra G n. 3, el Vendedor procederá a sustituir el producto defectuoso con otro con características iguales o superiores o, en el caso de que ello no sea posible, deberá efectuar una congrua reducción del precio. Como alternativa, el Comprador tendrá derecho, previa devolución de los productos viciados, al reembolso del precio pagado, agregándose el costo del transporte, con exclusión del resarcimiento de todo otro daño, directo y/o indirecto.

**H.4. La garantía del Vendedor debe considerarse excluida en caso de que el producto que presenta vicios evidentes (total o parcialmente) haya sido utilizado y/o, en cualquier caso, transformado, debiéndose estimar que de tal modo el Comprador (o su cliente) ha expresado la voluntad de aceptarlo en el estado en que se encuentra.** **H.5. En los casos en que quede comprobado que el producto presenta vicios ocultos, la garantía del Vendedor queda limitada a la sustitución del material con otro de características iguales o superiores y, allí donde ello no sea posible, al reembolso del precio pagado, agregándose el costo del transporte. En todo caso, la garantía del Vendedor por cada daño directo y/o indirecto de cualquier forma derivado de producto defectuoso, debe entenderse limitada a una suma que no podrá superar el doble del precio de venta aplicado por el Vendedor, con referencia solo a la parte defectuosa del suministro.**

**H.6.** En caso de que el Comprador revenda el producto a terceros protegidos por el código del consumo (D.L. n. 206/2005), será responsable de las condiciones practicadas si son diferentes de aquellas aquí señaladas y deberá comprobarse que los derechos del consumidor sean ejercidos con aplicación de los remedios y de los términos fijados por el antedicho código. En caso de subsistir las condiciones, el derecho de devolución y/o, en todo caso, de compensación a favor del Comprador respecto del Vendedor/productor, no podrán excederse las exenciones ni límites establecido en la letra G del n. 1 y en la letra H n. 5.

REV. 3 DE 1 DE SEPTIEMBRE 2020

INDEX

≡

PRODUCT  
FINDER

➤

SURFACE  
RANGE

➤

COMPANY

➤

COLLECTIONS

➤

LARGE SIZES

➤

TECHNICAL  
SPECIFICATIONS

➤

### I. CLÁUSULAS SOLVE ET REPETE Y RESOLUTIVAS

**I.1.** De conformidad con lo dispuesto por el art. 1462 del Código Civil, por ningún motivo, incluidos supuestos vicios o defectos del material, el Comprador podrá suspender o retardar el pago del material retirado, sin perjuicio obviamente de la facultad de restitución cuando pueda demostrar que ha pagado indebidamente.

**I.2.** En el caso de cambiar las condiciones patrimoniales del Comprador o de falta de pago incluso parcial de productos ya suministrados, el Vendedor podrá suspender la realización de los suministros en curso y/o rescindir los contratos en curso sin que el Comprador pueda reivindicar resarcimientos directos ni indirectos de cualquier clase.

### L.- PACTO DE RESERVADO DOMINIO

**L.1.** Mientras el Comprador no haya efectuado el pago integral del precio, los productos objeto del suministro seguirán siendo de propiedad del Vendedor.

**L.2.** Durante el período antedicho, el Comprador asumirá las obligaciones y las responsabilidades del depositario y no podrá enajenar, entregar en uso ni dejar retener o embargar los productos sin declarar la propiedad del Vendedor y enviar inmediatamente aviso con carta certificada con aviso de recibo.

### M.- FUERZA MAYOR

**M.1.** Cada parte podrá suspender la ejecución de sus obligaciones contractuales cuando esa ejecución se haga imposible u objetivamente demasiado onerosa por impedimento imprevisible independiente de su voluntad, tal como por ejemplo: huelga, boicot, bloqueo, incendio, guerra (declarada o no declarada), guerra civil, rebelión y revolución, requisición, embargo, interrupción de energía, rotura extraordinaria de maquinaria, retraso en la entrega de componentes o materias primas.

**M.2.** La parte que desee valerse de la presente cláusula deberá comunicar de inmediato por escrito a la otra parte el verificarse y el cese de las circunstancias de fuerza mayor.

**M.3.** En caso de que la suspensión causada por fuerza mayor dure más de 60 (sesenta) días, cada una de las partes tendrá derechos de rescindir el presente contrato, con preaviso de 10 (diez) días, a comunicar a la otra parte por escrito.

### N.- OBLIGACIÓN DE CONFIDENCIALIDAD

**N.1.** El Comprador debe mantener la más absoluta confidencialidad respecto de todas las informaciones de carácter técnico (tales como, solo como ejemplo, diseños, prospectos, documentaciones, fórmulas y correspondencia) y de carácter comercial (incluidas las condiciones contractuales, los precios de compra, las condiciones de pago, etc.) obtenidas a propósito de la ejecución del presente contrato.

**N.2.** La obligación de confidencialidad es válida por toda la duración del contrato, así como por el periodo sucesivo a su ejecución.

**N.3.** En cualquier caso de inobservancia de la obligación de confidencialidad, la parte incumplidora deberá indemnizar a la otra por todos los daños que de ello puedan derivar.

### O.- MARCAS Y SIGNOS DISTINTIVOS DEL VENDEDOR

**O.1.** Queda severamente prohibido el uso a través de cualquier medio (tales como, solo a título de ejemplos no exhaustivos: prensa, videos, radio, internet, social media, plataformas de mensajería instantánea o VoIP, etc.) de las marcas, de los modelos ornamentales y de las obras del ingenio en general que constituyan propiedad intelectual del Vendedor y ello en cualquier forma o modo de expresión (tales como, solo a título de ejemplos no exhaustivos: imágenes, fotos, dibujos, videos, figuras, estructuras, etc.). Cualquier excepción a esta prohibición, incluso solo parcial, deberá ser autorizada caso por caso por escrito por la dirección general del Vendedor.

### P.- IDIOMA DEL CONTRATO, LEY APLICABLE, JURISDICCIÓN Y COMPETENCIA

**P.1.** El contrato y las presentes condiciones son redactados en lengua italiana, la cual prevalecerá en caso de divergencia con las traducciones en otros idiomas.

**P.2.** La resolución de cualquier controversia de cualquier forma relativa al suministro queda sujeta a la ley y a la jurisdicción del Estado Italiano y la competencia territorial es asignada de forma exclusiva al Tribunal de Módena, en cuya circunscripción el Vendedor tiene su domicilio legal.

Para mayor información, consultar las Condiciones Generales de Venta, disponible en la dirección [www.atlasconcorde.com](http://www.atlasconcorde.com)

## ОБЩИЕ УСЛОВИЯ ПРОДАЖИ

### A.- ПОРЯДОК ЗАКЛЮЧЕНИЯ ДОГОВОРА

**A.1.** Настоящие Общие условия продажи регулируют любой договор продажи, заключенный между Продавцом и Покупателем; любое изменение или отступление от них должно быть согласовано в письменной форме.

**A.2.** Возможные коммерческие предложения, зачисления и/или бонусы, предоставленные агентами или другими посредниками, не имеют силы, если они не были подтверждены в письменной форме Продавцом.

**A.3.** Покупатель направляет Продавцу непосредственно или через агентов письменные заказы, в которых должны быть указаны коды запрошенной продукции, количества, цены и место назначения. Отправленный Покупателем заказ отмене не подлежит.

**A.4.** Продажа считается завершенной в тот момент, когда: (i) Покупатель получает от Продавца по электронной почте, факсу или другим телематическим средствам связи письменное подтверждение, соответствующее срокам и условиям заказа; или (ii) в случае, если в отправленном Продавцом подтверждении указаны условия, отличающиеся от условий в заказе Покупателя, если Покупатель письменно принимает это подтверждение или не возражает на него в течение 7 (семи) дней после его получения; или (iii) при отсутствии письменного подтверждения Продавца, в тот момент, когда Продукция передается Покупателю и загружается им.

**A.5.** Покупатель соглашается с необходимостью ограничить территорию продажи продукции Atlas Concorde государственными границами. Продавец считает это правило необходимым элементом, который позволил ему координировать свою коммерческую политику и оптимизировать дистрибутивную сеть посредством предложений, которые будут больше соответствовать потребностям отдельных стран. Аналогично этому, Покупатель соглашается, что эта необходимость представляет собой защиту также и его интересов. Таким образом, Покупатель обязуется реализовывать продукцию, поставленную компанией Ceramiche Atlas Concorde SpA, лишь только в его стране, воздерживаясь от продвижения активной продажи, также онлайновой, клиентам, находящимся на территории другой страны. В операциях триангуляции данное обязательство распространяется на страну, в которой ведется реальная оперативная деятельность Покупателя.

Покупатель сможет перепродать продукцию за пределами своей территории в том случае, если он получит письменное разрешение Продавца, или же в случае перепродажи продукции не первого сорта или снятой с производства.

### B.- ЦЕНЫ

**B.1.** При отсутствии иных письменных договоренностей согласованные в каждом отдельном случае отпускные цены подразумеваются как цены нетто, за наличный расчет и на условиях поставки франко завод Продавца, указанный в подтверждении заказа.

### C.- ХАРАКТЕРИСТИКИ ПРОДУКЦИИ

**C.1.** Покупатель заявляет, что он ознакомился и придерживается содержания следующей документации, размещенной на корпоративном сайте в интернете: 1) Руководство по укладке, использованию, чистке и уходу и 2) Технические данные.
**C.2.** Учитывая свойственное непостоянство керамической продукции, характеристики образцов и/ моделей, ранее отправленных Продавцом Покупателю, должны считаться ориентировочными и не обязывающими.
**C.3.** При отсутствии специальных требований, которые должны быть оговорены до подтверждения заказа, Продавец не гарантирует, что заказ на отдельное изделие будет полностью состоять из одной и той же производственной партии.

### D.- СРОКИ ПОСТАВКИ

**D.1.** Сроки поставки являются ориентировочными: их продление не дает Покупателю права на запрос компенсаций, без каких-либо исключений.

**D.2.** Если по истечении 14 (четырнадцать) дней с даты уведомления о готовности товара Покупатель не заберет материал, Продавец будет вынужден, по причине занимаемой площади, вернуть материал на склад, что приведет к дополнительным расходам; Продавец оставляет за собой право взыскать такие дополнительные расходы с Покупателя.

### E.- ДОСТАВКА И ОТГРУЗКА

**E.1.** О возможном изменении места назначения Продукции, если оно отличается от места, согласованного в подтверждении заказа, необходимо сообщить Продавцу в письменной форме не позднее, чем за два дня до даты, предусмотренной для вывоза товара с завода Продавца. Продавец оставляет за собой право не принимать изменение места назначения Продукции. Если устанавливается, что фактическое место назначения Продукции отличалось от заявленного Покупателем, то Продавец оставляет за собой право приостановку исполнения текущих поставок и/или на расторжение

текущих договоров без права Покупателя на требование прямого или косвенного возмещения какого-либо типа.

**E.2.** При отсутствии иных договоренностей поставка товара подразумевается на условиях франко-завод (EXW в соответствии с правилами Incoterms 2010), даже если было согласовано, что отгрузка или ее часть должна осуществляться Продавцом по поручению Покупателя. В любом случае риск переходит к Покупателю не позднее чем при передаче товара первому грузоперевозчику.

**E.3.** Исходя из того, что Продавец не является стороной договора перевозки, в нососаменте не допускается указание Продавца как "грузоотправителя".

Сообщение Продавцом грузоперевозчику веса брутто контейнера не является принятием на себя ответственности в соответствии с конвенцией СОЛАС (Safety Of Life At Sea). Это сообщение не может ни в коем случае толковаться как проверка массы груженых контейнеров VGM (Verified Gross Mass).

**E.4.** Покупатель обязуется направить на склад Продавца транспортное средство, пригодное для погрузки Продукции данного типа. Если прибывшее транспортное средство значительно затрудняет выполнение погрузочных операций, то Продавец оставляет за собой право наложить пеню в размере 4% от стоимости продукции за возмещение более высоких логистических расходов. Если согласованное транспортное средство является совершенно неподходящим, Продавец оставляет за собой право отказать в выполнении погрузочных операций, при этом Покупатель не может требовать возмещения вытекающего из этого любого прямого и/или косвенного убытка.

**E.5.** Покупатель обязан поручить грузоперевозчику проверку продукции перед ее погрузкой. Возможные замечания о целостности упаковки и о соответствии загруженных количеств тем, которые указаны в транспортной накладной, должны быть сделаны грузоперевозчиком в момент погрузки. Эти замечания необходимо указать во всех копиях транспортных накладных, в противном случае погруженная продукция считается неповрежденной и комплектной. Из этого следует, что Продавец не несет никакой ответственности за недостачи или повреждения продукции, не отмеченные грузоперевозчиком.

**E.6.** Кроме того, Покупатель также обязан поручить грузоперевозчику проверку порядка погрузки и стабильности груза в транспортном средстве, чтобы во время перевозки не возникли повреждения, и чтобы были соблюдены все правила безопасности дорожного движения.

### F.- ОПЛАТА

**F.1.** Любые платежные обязательства должны выполняться по юридическому адресу Продавца.Оплата агентам, представителям или торговым помощникам считается несовершенной до тех пор, пока соответствующие суммы не поступят Продавцу.

**F.2.** Покупателю запрещается выполнять свои обязательства путем оплаты из стран, не являющихся страной, резидентом которой он является, если эти страны не гарантируют адекватный обмен информацией с Италией. В случае нарушения этого запрета Продавец имеет право на расторжение договора с надлежащим правовым основанием, а у Покупателя не возникнет право на получение какого-либо возмещения за понесенный ущерб.

**F.3.** Пошлины и расходы на инкассирование векселей и тратт несет Покупатель. В случае даже частичной задержки платежа по сравнению с назначенным днем оплаты в пользу Продавца будут начисляться проценты в размере, предусмотренном законодательным декретом от 09/10/2002 № 231.

**F.4.** При отсутствии иных письменных договоренностей Покупатель обязуется не компенсировать никакой кредит по отношению к Продавцу, вне зависимости от причин его возникновения.

### G.- ПРЕТЕНЗИИ

**G.1.** При получении Продукции Покупатель должен внимательно осмотреть ее в соответствии с указаниями п. 7 стандарта UNI EN ISO 10545-2

**G.2.** При установке и укладке Продукции необходимо внимательно придерживаться рекомендаций по работам, выполняемым до и во время укладки, приведенных в документе 1) Руководство по укладке, использованию, чистке и уходу, размещенном на сайте Продавца в интернете, а также рекомендаций, указанных на упаковке изделия и/или приведенных внутри упаковки. Не считаются дефектами Продукции дефекты, возникшие в результате неправильной установки, отсутствия / неправильного ухода (не в соответствии с указаниями, приведенными в 1) Руководстве по укладке, использованию, чистке и уходу), по причине неподходящей сферы применения и/или обычного износа с течением времени.

**G.3.** Соблюдая пределы приемлемости, предусмотренные международным стандартом EN 14411 ( ISO 13006), стороны признают как явные дефекты те дефекты Продукции, которые были заметными уже при ее получении, и которые делают материал неподходящим для применения или существенно снижают его ценность. В эту категорию входят дефекты в соответствии с определением, приведенным в

документе 1) Руководство по укладке, использованию, чистке и уходу, размещенном на сайте Продавца в интернете. В качестве неисчерпывающего перечня признаются как явные дефекты следующие: дефекты поверхности, декора, шлифовки/полировки, калибра, плоскостности, ортогональности-прямолинейности, толщины, трещины, сколы, несоответствие тона, смещение тона, а также изделия с дефектами резки и сколами.

**G.4.** Если Покупатель обнаруживает явные дефекты, то он должен предъявить претензию Продавцу в письменном виде в течение 8 (восьми) дней с момента получения Продукции, в противном случае он теряет право на претензию, кроме того, Покупатель должен оставить всю партию материала в распоряжении Продавца. В претензии необходимо указать данные инвойса и точное описание дефекта, сопровождая его, если это возможно, фотографиями. Если претензия окажется необоснованной, то Покупатель должен быть готовым возместить Продавцу расходы, понесенные им в связи с осмотром на месте (экспертизы, проезд и т.д.).

**G.5.** О скрытых дефектах необходимо сообщать Продавцу заказным письмом с уведомлением о вручении в течение не более 8 (восьми) дней с момента обнаружения дефекта, в противном случае гарантия теряет силу.

**G.6.** В любом случае, предоставленная Покупателю гарантия на дефекты теряет силу по истечении 12 (двенадцати) месяцев с момента получения Продукции.

### H.- ГАРАНТИЯ НА ДЕФЕКТЫ

**H.1.** Гарантия Продавца распространяется только на Продукцию первого сорта, и не распространяется на Продукцию второго, третьего сорта, а также на партии со спецпредложениями, по которым были предложены специальные скидки или цены, отмеченные в примечаниях в подтверждении заказа.

**H.2.** Продавец не гарантирует пригодность Продукции для специальных видов применения, а лишь только ее технические характеристики, размещенные на сайте в интернете, в документе 2) Технические данные. Сфера применения, даже если она указана Продавцом в каталогах и руководствах, должна считаться лишь только ориентировочной. На основании технических характеристик, приведенных в 2) Технические данных, проектировщик обязан оценить пригодность Продукции к конкретным условиям применения, в зависимости от нагрузок и от переменных факторов, которые могут возникнуть в среде применения, изменяя характеристики Продукции, такие как: интенсивность хождения, качество хождения (наличие песка, мусора и т.д.), возможные неблагоприятные климатические условия и любые другие случайные факторы, которые могут оказать воздействие на материал.

**H.3.** В случае установления того факта, что Продукция имеет явные дефекты в соответствии с положениями п. 3 раздела G, Продавец заменит дефектную Продукцию другой, обладающей такими же или более высокими характеристиками. Если это невозможно, то он надлежащим образом снизит цену. В качестве альтернативы после возврата дефектной Продукции Покупатель имеет право на возмещение уплаченной цены и транспортных расходов, при этом исключено возмещение любого другого прямого и/или косвенного ущерба.

**H.4. Гарантия Продавца считается отмененной в случае, если Продукция, частично или полностью имеющая явные дефекты, была использована и/ или трансформирована каким-либо образом, поскольку считается, что этими действиями Покупатель (или его клиент) выразил волю принять Продукцию в том состоянии, в котором она находится.**

**H.5. В случае установления того факта, что Продукция имеет скрытые дефекты, гарантия Продавца ограничена заменой материала другим, обладающим такими же или более высокими характеристиками. Если это невозможно, то Продавец возмещит уплаченную цену и транспортные расходы. В любом случае, гарантия Продавца на любой прямой и/или косвенный ущерб, вызванный каким-либо образом дефектной Продукцией, ограничена суммой, которая не может превышать больше, чем в два раза, востребованную Продавцом отпускную цену, и лишь только в отношении к дефектной части поставки.**

**H.6.** Если Покупатель перепродает Продукцию лицам, которые защищены Кодексом потребителя (законодательный декрет № 206/2005), то он несет ответственность за предоставляемые условия, если они отличаются от приведенных здесь, кроме того, он обязан удостовериться в том, что права потребителя защищаются с соблюдением мер и сроков, предусмотренных вышеуказанным Кодексом.При наличии соответствующих предпосылок право регресса и/или право на взыскание убытков, которое Покупатель имеет по отношению к Продавцу/производителю, не может превышать исключения и пределы, установленные в п. 1 раздела G и в п. 5 раздела H.

КОРРЕКТИРОВКА 3 ОТ 1 СЕНТЯБРЯ 2020 Г.

## И. УСЛОВИЯ ОБ ОБЯЗАТЕЛЬНОЙ ОПЛАТЕ (SOLVE ET REPETE) И О ДОСРОЧНОМ ОДНОСТОРОННОМ РАСТОРЖЕНИИ

**I.1.** В соответствии со ст. 1462 гражданского кодекса Покупатель не вправе ни по какой причине, в том числе в связи с претензиями по поводу качества или дефектности товара, приостанавливать или задерживать оплату вывезенного материала, сохраняя, тем не менее, право требовать возмещение, если он докажет неправомерное взимание оплаты.

**I.2.** В случае изменения имущественного положения Покупателя или даже частичной неоплаты уже поставленной Продукции, Продавец может приостановить исполнение текущих поставок и/или расторгнуть текущие договоры, и Покупатель не имеет права потребовать какого-либо возмещения прямых и/или косвенных убытков.

### L.- ПОЛОЖЕНИЕ О СОХРАНЕНИИ ПРАВА СОБСТВЕННОСТИ

**L.1.** Поставляемая Продукция будет оставаться в собственности Продавца до тех пор, пока Покупатель полностью не оплатит ее.

**L.2.** В течение этого периода Покупатель несет обязательства и ответственность хранителя и не может уступать, предоставлять в пользование, разрешать наложение имущественного ареста или опись Продукции, не заявив, что она находится в собственности Продавца, и не известив его немедленно заказным письмом с уведомлением о вручении.

### M.- ФОРС-МАЖОР

**M.1.** Любая из сторон имеет право приостановить исполнение своих контрактных обязательств, если это исполнение стало невозможным или объективно обременительным по причине непредвиденных событий, находящихся вне ее контроля, таких как, например: забастовка, бойкот, локаут, пожар, война (объявленная или нет), гражданская война, бунт, революция, конфискация, эмбарго, энергетическая блокада, непредвиденный выход из строя оборудования, задержки в поставках компонентов или сырья.

**M.2.** Сторона, желающая сослаться на настоящее условие, должна немедленно сообщить в письменной форме другой стороне о возникновении и прекращении форс-мажорных обстоятельств.

**M.3.** Если приостановка в связи с форс-мажорными обстоятельствами продлится более 60 (шестидесяти) дней, то каждая из сторон имеет право расторгнуть настоящий договор, отправив предварительное письменное уведомление об этом другой стороне за 10 (десять) дней.

### N.- ОБЯЗАТЕЛЬСТВО О НЕРАЗГЛАШЕНИИ КОНФИДЕНЦИАЛЬНОЙ ИНФОРМАЦИИ

**N.1.** Покупатель обязан соблюдать максимальную конфиденциальность о всей информации технического характера (такая как, но не ограничиваясь этим, чертежи, проспекты, документация, формулы и переписка) и коммерческого характера (включая договорные условия, отпускные цены, условия платежа и т.д.), которая попала в его распоряжение в ходе исполнения настоящего договора.
**N.2.** Обязательство о неразглашении конфиденциальной информации действует в течение всего срока действия договора, а также в период после его исполнения.
**N.3.** В случае невыполнения обязательства о неразглашении конфиденциальной информации невыполняющая сторона обязана возместить другой стороне все убытки, вытекающие из ее нарушения.

### O.- ТОРГОВЫЕ МАРКИ И ОТЛИЧИТЕЛЬНЫЕ ЗНАКИ ПРОДАВЦА

**O.1.** Категорически запрещается использование торговых марок, орнаментальных промышленных образцов и предметов интеллектуальной собственности вообще, в любом виде или форме выражения (например, только в качестве неполного перечня: изображения, фотографии, чертежи, видеосъемки, рисунки, конструкции и т.д.), являющихся интеллектуальной собственностью Продавца, в любых СМИ (например, только в качестве неполного перечня: печать, видеоканалы, радиовещание, интернет, социальные сети, платформы для обмена сообщениями или VoIP-платформы). Любое, даже только частичное отступление от этого запрета должно письменно разрешаться в каждом отдельном случае Генеральной дирекцией Продавца.

### P.- ЯЗЫК ДОГОВОРА, ПРИМЕНИМЫЙ ЗАКОН, ЮРИСДИКЦИЯ И КОМПЕТЕНЦИЯ

**P.1.** Договор и настоящие условия составлены на итальянском языке, который преобладает в случае разночтений с переводом на другие языки.

**P.2.** Любой спор, каким-либо образом связанный с поставками, регулируется итальянским законом и подлежит юрисдикции Итальянского государства, а территориальная компетенция принадлежит исключительно суду г. Модены, в округе которого Продавец имеет свой юридический адрес.

Больше информации можно найти в Общих условиях продажи по адресу [www.atlasconcorde.com](http://www.atlasconcorde.com)

## INDEX

INDEX

INDEX

INDEX

INDEX

INDEX

INDEX

INDEX

INDEX

INDEX

INDEX

INDEX

INDEX

INDEX

INDEX

INDEX

INDEX

INDEX

INDEX

INDEX

INDEX

INDEX

INDEX

INDEX

INDEX

INDEX

INDEX

INDEX

INDEX

INDEX

INDEX

INDEX

INDEX

INDEX

INDEX

INDEX

INDEX

INDEX

INDEX

INDEX

INDEX

INDEX

INDEX

INDEX

INDEX

INDEX

INDEX

INDEX

INDEX

INDEX

INDEX

INDEX

INDEX

INDEX

INDEX

INDEX

INDEX

## NOTES

### **Atlas Concorde reserves the right to modify any product without notice and will not be liable for any direct or indirect damage resulting from such modifications.**

Atlas Concorde si riserva di modificare i prodotti senza preavviso, declinando ogni responsabilità su eventuali danni diretti o indiretti derivanti da eventuali modifiche. – Atlas Concorde se réserve le droit de modifier ses produits sans préavis et décline toute responsabilité concernant les éventuels dommages directs ou indirects qui pourraient dériver de ces modifications – Atlas Concorde behält sich das Recht vor jederzeit und ohne vorherige Ankündigung, die Produkte zu verändern, und lehnt jede Haftung bei direkten oder indirekten Schäden ab, die von diesen Veränderungen herrühren – Atlas Concorde se reserva el derecho de modificar los productos sin previo aviso, rechaza cualquier responsabilidad sobre eventuales daños directos o indirectos derivados de eventuales modificaciones – Atlas Concorde оставляет за собой право изменять характеристики изделий без предварительного уведомления, отклоняя при этом любую ответственность за прямые или косвенные убытки, возникшие в результате изменений.

### **Colours and optical features of the materials illustrated in this catalogue are to be regarded as mere indications.**

I colori e le caratteristiche estetiche dei materiali illustrati nel presente catalogo sono da ritenersi puramente indicativi. – Les coloris et les caractéristiques esthétiques des références illustrées dans le catalogue sont donnés à titre purement indicatif – Die Farben und die ästhetischen Eigenschaften der in diesem Katalog abgebildeten Produkte sind als reine Richtwerte zu betrachten – Los colores y las características estéticas de los materiales ilustrados en el presente catálogo deben ser considerados como puramente indicativos – Цвета и эстетические характеристики описанных в настоящем каталоге материалов являются только ориентировочными.

### **For information and details relating to codes, packaging and weight it is recommended to refer to the latest pricelist.**

Per le informazioni e i dati relativi a codici, imballaggi e pesi occorre sempre consultare l'ultimo listino aggiornato e in vigore. – Pour toutes informations et renseignements concernant les codes, les emballages et les poids, il y a toujours lieu de consulter le dernier tarif en vigueur et mis à jour – Für Informationen und Daten die den Code, die Verpackung und das Gewicht betreffen bitte die aktuellste Preisliste zugrunde legen – Para acceder a la información y a los datos relativos a códigos, embalajes y pesos hay que consultar siempre la última lista de precios actualizada y vigente – Для информации о кодах, упаковках и весе обращайтесь к последнему действующему прайс-листу.

### **Ceramic products can have slight variations in tone. Check with the sales representative for the possibility of combining production lots, formats, decorations and special pieces.**

Il prodotto ceramico può essere leggermente variabile in termini di toni. Verificare con il referente commerciale l'abbinabilità sia tra i lotti produttivi che tra i formati e i decori o i pezzi speciali. – Le produit céramique peut légèrement différer sur l'aspect de la couleur. Vérifier avec le référent commercial que l'assortiment soit entre les lots de fabrication qu'entre les formats et les décors ou les pièces spéciales – Im keramischen Produkt sind Abweichungen von Farbton möglich. Wenden Sie sich bitte an den Verkaufsleiter, um zu überprüfen, wie man die verschiedenen Posten, Formate, Dekore oder Spezialteile miteinander kombinieren kann – El producto cerámico puede variar levemente en lo que respecta a los tonos. Consulte con el representante de ventas la combinación entre los lotes producidos y entre los formatos y las decoraciones o las piezas especiales – Керамические изделия разных партий могут слегка отличаться по тону. Проверьте вместе с торговым представителем сочетаемость с изделиями других партий, а также с форматами, декоративными или специальными элементами.

### **The production sizes of special pieces in porcelain tiles may vary from the nominal sizes provided for in current standards (ISO 13006 – EN 14411 Annex G) for non-modular tiles.**

Le dimensioni di fabbricazione dei pezzi speciali in gres porcellanato possono derogare dalle dimensioni nominali previste dalle normative vigenti (ISO 13006 – EN 14411 appendice G) per le piastrelle non modulari. – Les dimensions de fabrication des pièces spéciales en grès cérame peuvent déroger aux dimensions nominales prévues par les règlements en vigueur (ISO 13006 – EN 14411 annexe G) pour les carreaux non modulaires. | Die Produktionsmaße der Formteile aus Feinsteinzeug können für die nicht modularen Fliesenformate von den Sollmaßen der geltenden Normen (ISO 13006 – EN 14411 Anhang G) abweichen. – Los tamaños de fabricación de las piezas especiales de gres porcelánico pueden ser diferentes de las dimensiones nominales previstas por las normas vigentes (ISO 13006 – EN 14411 apéndice G) para las baldosas no modulares. – Производственные размеры специальных элементов из керамогранита могут отклоняться от номинальных размеров, предусмотренных действующими стандартами (ISO 13006 – EN 14411, Приложение G) для немодульных плиток.

### **The actual dimensions of the special pieces and the smaller pieces obtained by cutting porcelain tiles could deviate from the tolerances in the catalog, which instead for the rectified formats are guaranteed by Atlas Concorde.**

Le dimensioni reali dei pezzi speciali e dei sottoformati ottenuti da tagli in gres porcellanato potrebbero derogare rispetto alla tolleranze presenti a catalogo garantite da Atlas Concorde sui formati rettificati. – Les dimensions réelles des pièces spéciales et des sous formats obtenus à partir des coupes en grès cérame pourraient varier par rapport aux tolérances présentes au catalogue garanties par Atlas Concorde sur les formats rectifiés. – Die tatsächlichen Abmessungen der Formstücke und der geschnittenen Unterformate aus Feinsteinzeug können von den im Katalog genannten, von Atlas Concorde für rektifizierte Formate garantierten Toleranzen abweichen. – Las dimensiones reales de las piezas especiales y de los subformatos obtenidos por cortes de gres porcelánico, podrían no cumplir con las tolerancias indicadas en el catálogo, garantizadas por Atlas Concorde para los formatos rectificados. – Фактические размеры специальных элементов и подформатов, полученных путем разрезания керамогранита, могут отклоняться от допусков, указанных в каталоге и гарантируемых компанией Atlas Concorde для ретифицированных форматов.

**Copyright 2022 by Ceramiche Atlas Concorde S.p.A - The reproduction of the work, fully or in part, is strictly forbidden.**

Copyright 2022 by Ceramiche Atlas Concorde S.p.A - È vietata la riproduzione, anche parziale, dell'opera in tutte le sue forme.

Copyright 2022 by Ceramiche Atlas Concorde S.p.A - Toute reproduction, même partielle, de l'œuvre dans toutes ses formes est interdite.

Copyright 2022 by Ceramiche Atlas Concorde S.p.A - Die Reproduktion, ganz oder teilweise, des Werkes in all seinen Formen ist verboten.

Copyright 2022 by Ceramiche Atlas Concorde S.p.A - Está prohibida la reproducción, incluso parcial, de la obra en todas sus formas.

Copyright 2022 by Ceramiche Atlas Concorde S.p.A - Запрещается любое полное или частичное воспроизведение данной работы.

February 2022



Ceramiche Atlas Concorde S.p.A.  
Via Canaletto 141  
41042 Spezzano di Fiorano (MO) - Italia

Atlas Concorde USA, Inc.  
117 Seaboard Lane - Suite F170  
Franklin, TN 37067 - USA

Atlas Concorde Russia  
Business centre "Meliora Place"  
Prospekt Mira 6  
129090 Moscow - Russia

[atlasconcorde.com](http://atlasconcorde.com)