

Montessori House Bedframe Assembly Guide & Warranty

Please Read and Retain this document!

Includes warranty replacement instructions and important safety information

Montessori House Bedframe
2MamaBees Inc.
www.2mamabees.com
info@2mamabees.com
833-MAMABEE (626-2233)

Contents
Warnings
Maintenance
Assembly Prep
Tools and Part Inventory
Step-by-Step Assembly



Warnings and Safe Use



Warnings and FAQs

Read this entire manual before assembling the bedframe.

Keep manual after assembly to easily order replacement parts or to disassemble properly.

Assembly requires two adults. If necessary, seek professional help to assemble if you are uncertain about any of the steps listed.

Keep hardware and tools out of reach of children before assembly.

Prepare recommended area before beginning assembly.

Please see "Assembly and Layout" on page for further information.

Bedframe must be completely assembled and inspected for sharp edges or protruding hardware before use by children. Failure to do so may result in injury and/or voiding of warranty.

Missing or damaged parts? Please email info@2mamabees.com or call 833-MAMABEE (626-2233).

(You will need model number and part number. Model number is found on the front page of this manual and part numbers and descriptions are listed on each page).



Proper Use

- Bedframe is intended for children aged 2 to 10 years of age.
- Bedframe is designed for private at-home use only in indoor settings only.
- Bedframe is not intended for public or business use (such as daycare, preschool, nursery, or other commercial applications). Any use of this sort will void warranty.

Safe Use

To reduce the risk of injury or death, you must follow these instructions:

- Adults should check for damaged wood, missing or loose hardware, or any sharp edges before every use. *Replace, tighten and smooth rough edges between uses. Lubricate any moving parts when needed.*
- Adults should ensure the bedframe is on a flat and level surface and does not rock due to an uneven ground.
- Do not let children climb on roof of bedframe.



Disposal



Disposal Instructions:

When the Bedframe use is no longer desired, it should be disassembled and disposed of in such a way that no unreasonable hazards will exist at the time the unit is discarded.

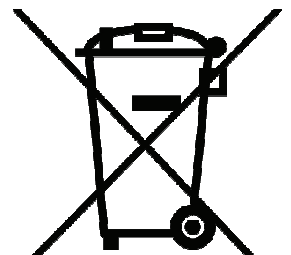



Warranty and Maintenance



Maintenance

- As part of safe use, we recommend regular checks of bedframe before use by children.
- All wood parts are made from furniture grade wood and sealed with a water-based sealant. Weathering from long term use will cause moisture content of the wood to shift and cause checking, warping, and fading. While these changes will not impact the integrity of the product, we advise regular maintenance to slow the speed and amount of weathering.
- In order to slow normal weathering and ensure warranty is not voided, it is required that a layer of sealant be applied to all wood surfaces every 1-2 years (yearly for areas that are humid and hot, every 2 years for areas that are dry. Before sealing, lightly sand wood pieces where there might be rough spots. This will reduce the rate of fading.

Limited Warranty

All products carry a 1-year replacement warranty on all parts for manufacturer's defect (which covers wood, hardware, and accessories). Our wood carries a 5 year warranty on rot and decay as well.

This Limited Warranty does not cover:

- Labor for any inspection
- Labor for replacement of any defective item(s)
- Incidental or consequential damages
- Cosmetic defects which do not affect performance or integrity of a part or the entire product
- Vandalism, theft, improper use, failure due to loading or use beyond the capacities stated in the applicable Assembly Manual.
- Acts of nature including but not limited to wind, earthquake, storms, hail, floods, fires, excessive water exposure
- Improper installation including but not limited to installation on uneven, unlevelled, or soft ground
- Minor twisting, warping, checking, or any other natural occurring properties of wood that do not affect performance or integrity

2MamaBees Bed frames have been designed for safety and quality. Modifications beyond painting could damage the structural integrity of product and lead to injury from product failure. Any modifications will void all warranties and guarantees.

Part Replacement -

- Cost of parts (damaged or missing) will be covered by 2MamaBees for the first year. This includes Shipping & Handling.
- All replacement parts after first year of ownership will be charged as follows - Discount on parts will decrease by 20% for every year of ownership of bedframe. (Ex - Year 1 customer pays 20% of cost, Year 2 customer pays 40%, and so on). All shipping and handling will be covered by customer.
- Warranty is voided if use in any non-residential setting such as playgrounds, parks, daycares, or business settings.
- Warranty is non-transferable

This Warranty gives you specific legal rights. You may have other rights as well which vary from state to state or province to province. This warranty excludes all consequential damages, however, some states do not allow the limitation or exclusion of consequential damages and therefore this limitation may not apply to you.



Necessary Tools (Not Included)

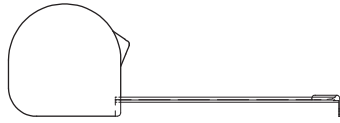

Tape Measure

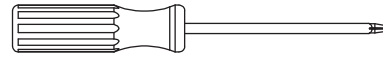

Phillips Screw Driver



Phillips Head
Drill Attachment

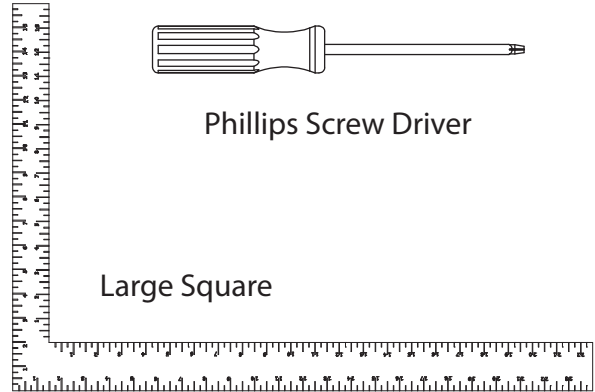

Large Square

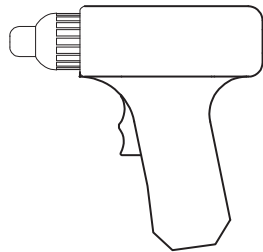

Cordless Drill or Electric Drill

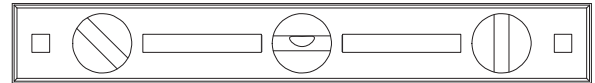

24" Level



Hardware Included

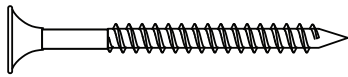

QUANTITY 8
S5 Screw:
5.0 cm/ 1.96 in

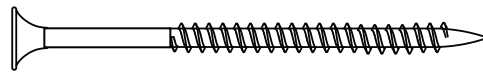

QUANTITY 20
S6 Screw:
7.0 cm/ 2.75 in

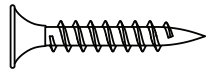

QUANTITY 16
S2 Screw:
1.5 cm/ .6 in

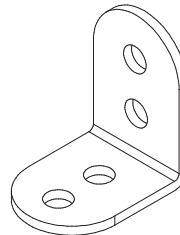



QUANTITY 4
L-Bracket





Wooden Components(Not to Scale)



T1  x4

T2  x4

T3  x4

T4  x4

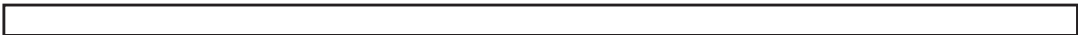
LEG  x1

PARTS

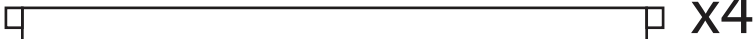

STEP 1:

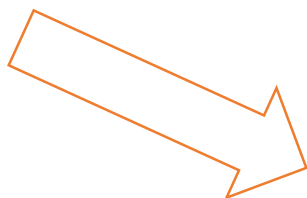
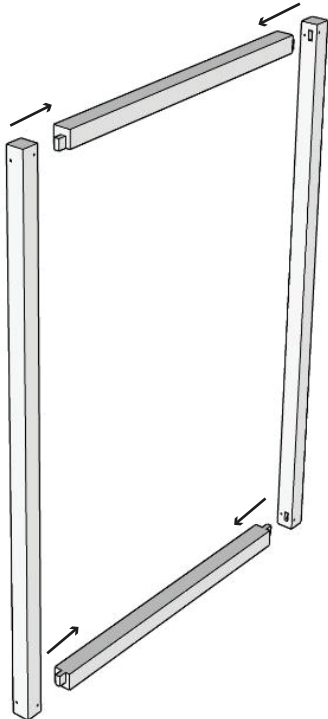

1

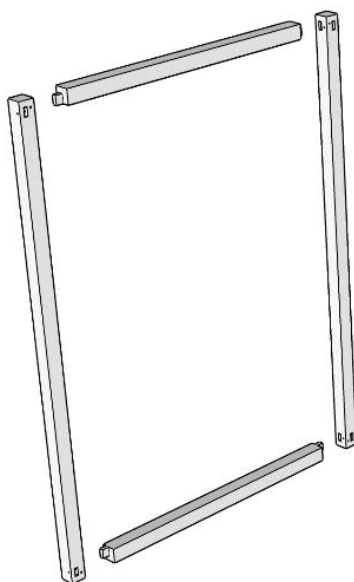

2

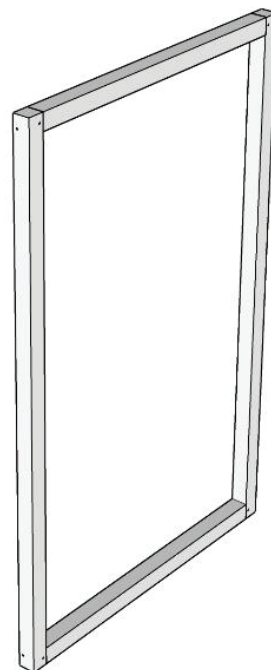

PARTS

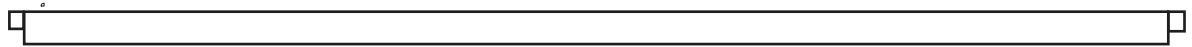

x4

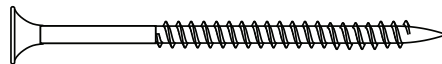

HARDWARE

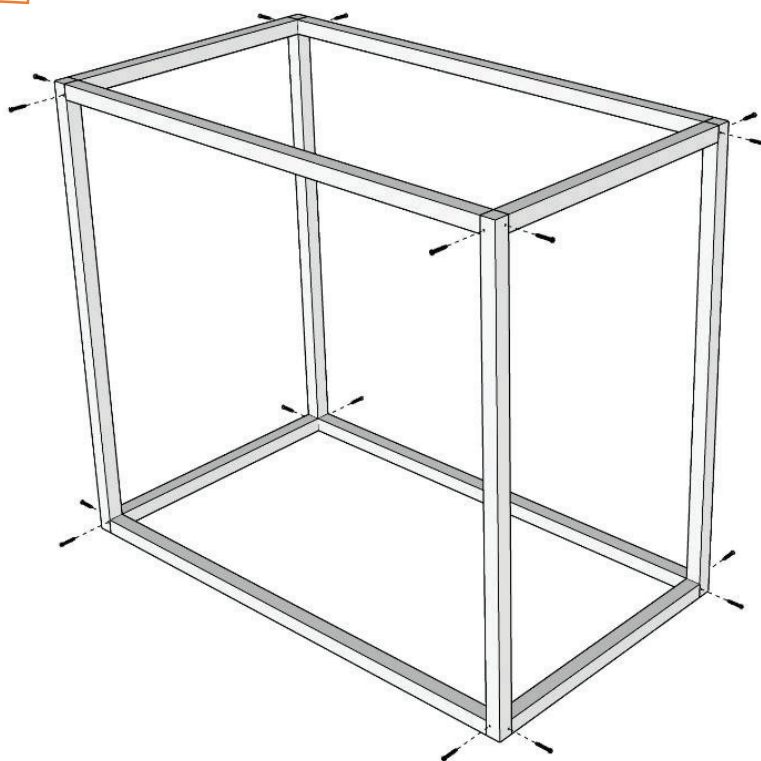
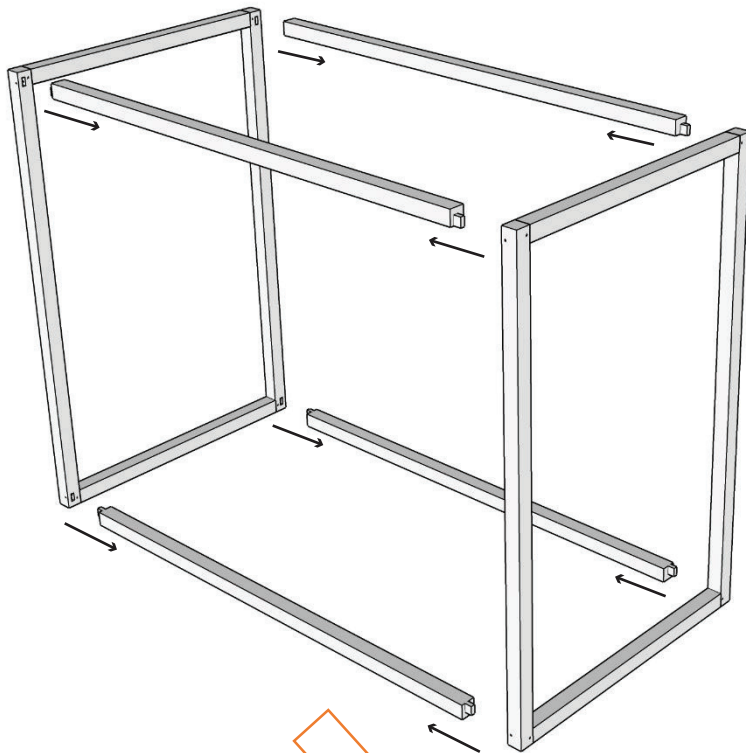

Qty 16- S6 Screw:
7.0 cm/ 2.75 in

STEP 2:

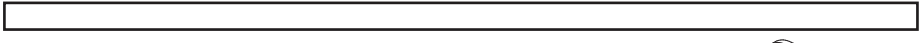
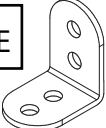
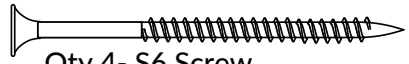
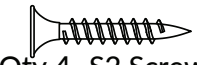

PARTS		HARDWARE			Qty 4- S6 Screw
	x4			Qty 4- S2 Screw:	

STEP 3:

