

PSA, PSL, PSS series

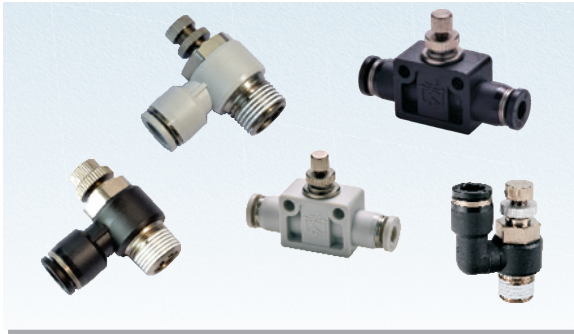

Symbol

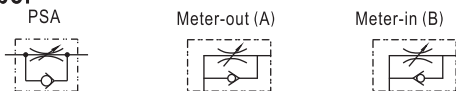

Product feature

1. The silencer is small size, and light weight with small installation space.
2. Excellent flow characteristics, high sensitivity and easy to adjust.
3. The silencer brass body adopts a special nickel-plating process, which has good corrosion resistance and anti-pollution property.
4. Anti-drop structure is designed on the regulating rod.
5. The sealant being coated on threaded portion can ensure no leakage of the threaded connection part.
6. The inserting direction of universal speed controller can be adjusted in 360 degree.

Ordering code

PSL 6 01 A □ □

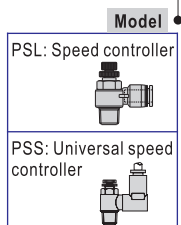

Port size

4: Φ4mm
6: Φ6mm
8: Φ8mm
10: Φ10mm
12: Φ12mm

Thread connection

Thread connection	Adaptable port size
M5: M5 × 0.8	Φ4\Φ6
01: 1/8"	
02: 1/4"	Φ4\Φ6
03: 3/8"	Φ8\Φ10
04: 1/2"	Φ12

Thread type
Blank: PT

Standard color

Standard color	Specification
Blank:	Release button: Gray Body: Gray
Gray:	Release button: Black Body: Black
D: Black:	

Control method

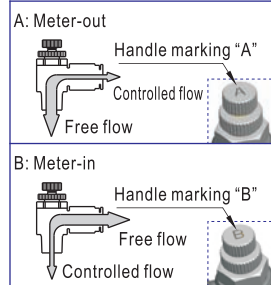

PSA 6 □

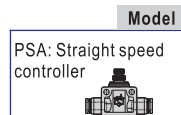

Port size

4: Φ4mm
6: Φ6mm
8: Φ8mm
10: Φ10mm
12: Φ12mm

Standard color

Standard color	Specification
Blank: Gray:	Release button: Gray Body: Gray
D: Black:	Release button: Black Body: Black

Specification

Operating pressure range	0~9kgf/cm ² (0~0.9MPa)
Negative pressure	-750mmHg(10Torr)
Proof pressure	1.5MPa
Ambient and fluid temperature (°C)	0~60
Applicable tubing	Soft nylon or polyurethane
Color	Grey/black

Table for interface port and tube O.D.

Product series	Thread type	Port size				
		Φ4	Φ6	Φ8	Φ10	Φ12
PSL	M5	●	●			
	1/8"	●	●	●		
	1/4"		●	●	●	
	3/8"		●	●	●	●
PSS	M5	●				
	1/8"		●	●		
	1/4"		●	●	●	
	3/8"				●	●
	1/2"					●

Product series	Port size				
	Φ4	Φ6	Φ8	Φ10	Φ12
PSA	●	●	●	●	●

Inner structure

Model: PSA

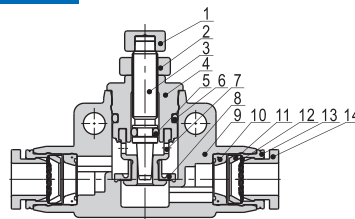

NO.	Name	Material
1	Adjusting cap	Aluminum alloy or Brass
2	Locking cap	Aluminum alloy
3	Throttling column	Brass
4	Throttling body	Brass
5	O-ring	NBR
6	O-ring	NBR
7	Throttling sleeve	Aluminum alloy
8	O-ring	NBR
9	Plastic body	PBT
10	O-ring	NBR
11	Locating seat	POM
12	Spring gasket	Stainless steel
13	Locating ring	Aluminum alloy
14	Plastic interface	POM

Model: PSL

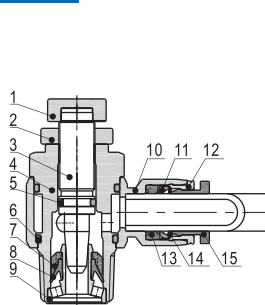

No.	Item	Material
1	Handle	Aluminum alloy or Brass
2	Lock nut	Aluminum alloy
3	Needle	Brass
4	Body	Brass
5	O-ring	NBR
6	O-ring	NBR
7	Bushing	PBT
8	O-ring	NBR
9	Seat ring	Brass
10	Rubber body	PBT
11	Chuck	POM
12	Guide	Aluminum alloy
13	O-ring	NBR
14	Spring gasket	Stainless steel
15	Release button	POM

Model: PSS

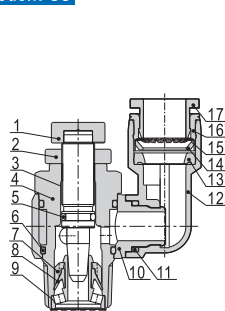

NO.	Name	Material
1	Adjusting cap	Aluminum alloy or Brass
2	Locking cap	Aluminum alloy
3	Throttling column	Brass
4	Throttling body	Brass
5	O-ring	NBR
6	O-ring	NBR
7	Holder	PBT
8	O-ring	NBR
9	Throttling sleeve	Brass
10	Plastic body	PBT
11	O-ring	NBR
12	Plastic body	PBT
13	O-ring	NBR
14	Locating seat	POM
15	Spring gasket	Stainless steel
16	Locating ring	Aluminum alloy
17	Plastic interface	POM



Speed controller

PSA, PSL, PSS series

■ Dimensions

PSL series

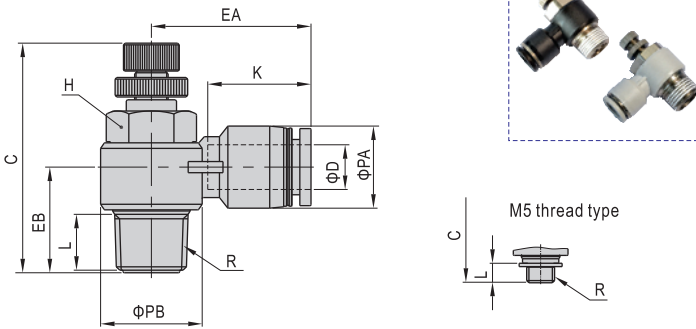

Model\Item	ΦD	R	ΦPA	ΦPB	L	C		K	EA	EB	H(Across flat)	Weight(g)
						max	min					
PSL4M5□	4	M5×0.8	9	10	3.5	30	27.5	14	19	9.5	8	6.5
PSL401□	4	1/8"	9	14	7.5	41.5	35	14	20.5	15	11	16.5
PSL6M5□	6	M5×0.8	12.5	10	3.5	30	27.5	16.5	23.5	11.5	8	8
PSL601□	6	1/8"	12.5	14	7.5	41.5	35	16.5	23	15.5	11	17.5
PSL602□	6	1/4"	12.5	18	10	47.5	41	16.5	25	18	14	32
PSL603□	6	3/8"	12.5	22.5	11	52.5	45.5	16.5	27	20	19	59.5
PSL801□	8	1/8"	15	14	7.5	41.5	35	18.5	26.5	16.5	11	18
PSL802□	8	1/4"	15	18	10	47.5	41	18.5	28.5	19	14	33
PSL803□	8	3/8"	15	22.5	11	52.5	45.5	18.5	29.5	20	19	60
PSL804□	8	1/2"	15	28	14	58.5	51.5	18.5	32	25	24	96.5
PSL1002□	10	1/4"	18	18	10	47.5	41	21	31	20.5	14	34.5
PSL1003□	10	3/8"	18	22.5	11	52.5	45.5	21	33	21.5	19	62
PSL1004□	10	1/2"	18	28	14	58.5	51.5	21	35.5	25.5	24	98
PSL1203□	12	3/8"	21	22.5	11	52.5	45.5	23	36	23.5	19	64
PSL1204□	12	1/2"	21	28	14	58.5	51.5	23	38	27	24	100

Note: "□" stands for A or B. A indicates meter-out type while B indicates meter-in type. The two types are with the same overall dimension.

PSS series

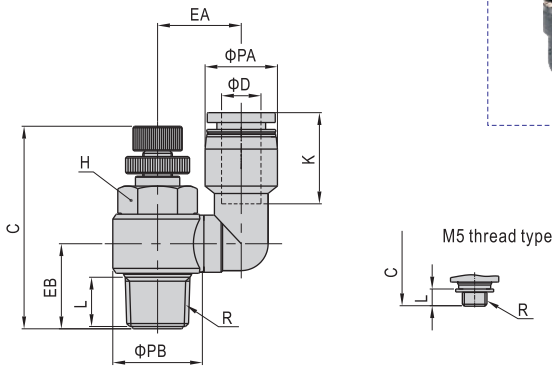

Model\Item	ΦD	R	ΦPA	ΦPB	L	C		K	EA	EB	H(Across flat)
						max	min				
PSS4M5□	4	M5×0.8	9	10	3.5	30	27.5	14	12.5	9.5	8
PSS601□	6	1/8"	12.5	14	7.5	41.5	35	17	17	15	11
PSS602□	6	1/4"	12.5	18	10	47.5	41	17	19	17.5	14
PSS801□	8	1/8"	15	14	7.5	41.5	35	18.5	17	15	11
PSS802□	8	1/4"	15	18	10	47.5	41	18.5	19	17.5	14
PSS1002□	10	1/4"	18	18	10	47.5	41	21	20.5	17.5	14
PSS1003□	10	3/8"	18	22.5	11	52.5	45.5	21	24	20	19
PSS1203□	12	3/8"	21	22.5	11	52.5	45.5	23	25.5	20	19
PSS1204□	12	1/2"	21	28	14	58.5	51.5	23	28	25	24

Note: "□" stands for A or B. A indicates meter-out type while B indicates meter-in type. The two types are with the same overall dimension.

PSA series

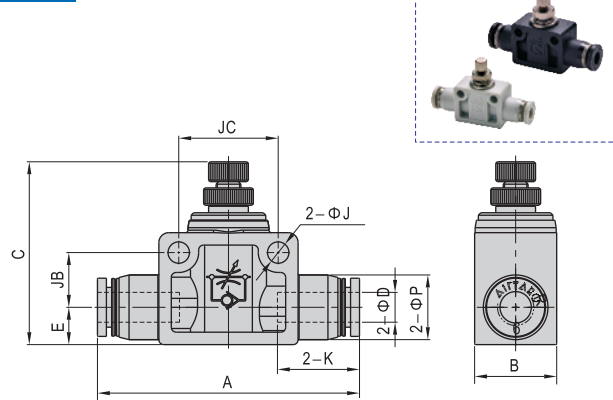

Model\Item	ΦD	A	B	C		ΦP	K	E	ΦJ	JB	JC
				max	min						
PSA4	4	41	11	29	26.5	9.5	14	7	3.2	6	14
PSA6	6	52.5	16.5	43.5	36.5	13	16.5	7.5	4.3	11	20
PSA8	8	59.5	16.5	47	40	15	18.5	8.5	4.3	11	22
PSA10	10	69	21	53.5	46.5	18	21	10.5	4.3	14.5	26
PSA12	12	78.5	26	58.5	51	21.5	23	12	4.3	17.5	32

■ Flow chart

Controlled flow rate

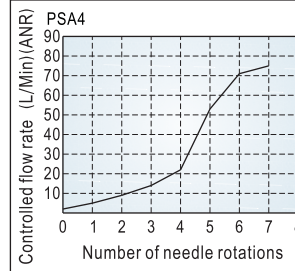

Free flow rate

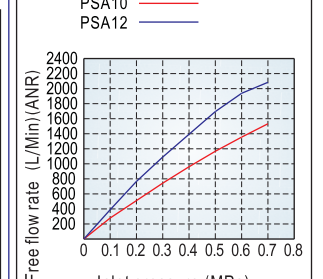
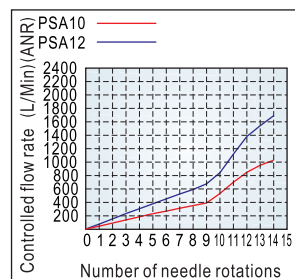
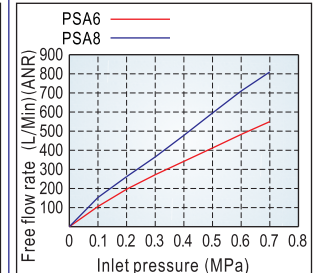
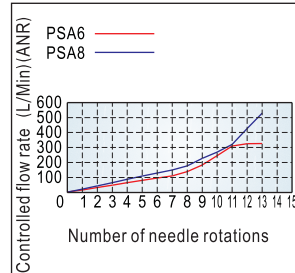
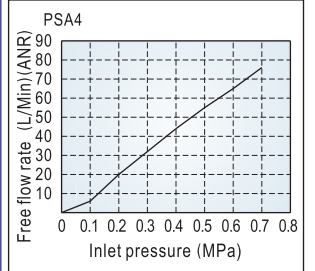

Speed controller



Controlled flow rate

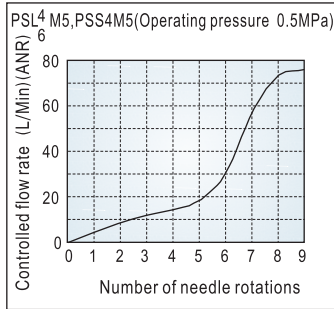

Free flow rate

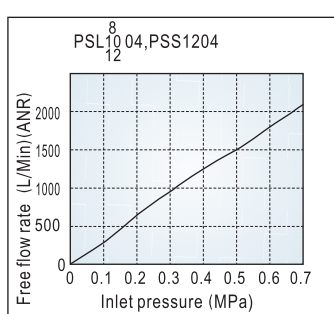
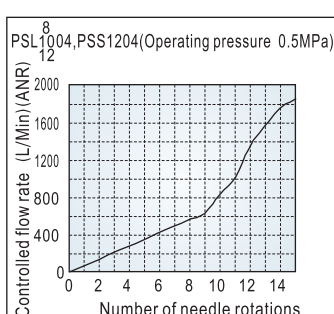
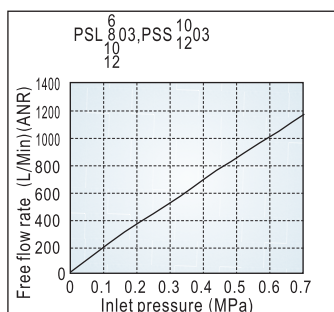
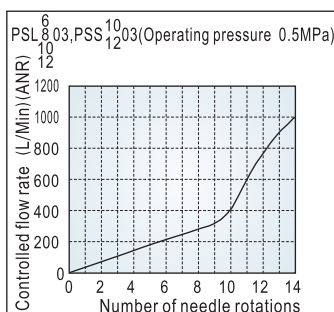
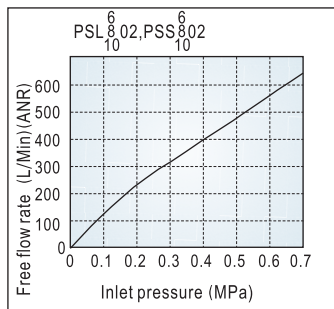
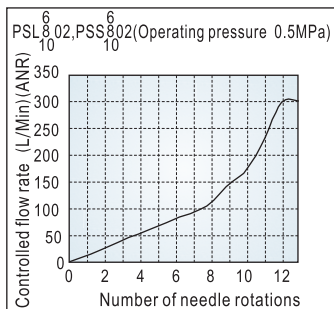
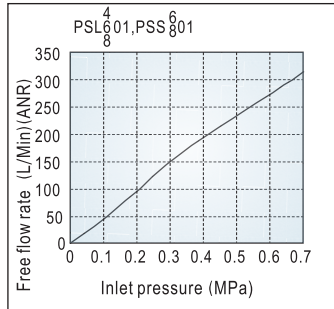
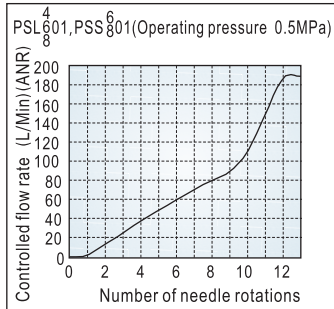
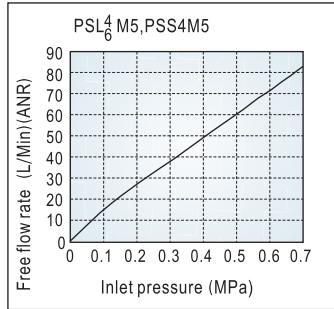

Selection, Installation and Operation

Selection

- The speed controller has meter-out type and meter-in type:

Working principle



- A: Meter-out**
- The air flow is controlled from the threaded end to tubing connection end.
 - The air flow is free from the tubing connection end to the threaded end.

Product identification

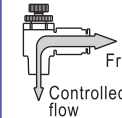

- B: Meter-in**
- The air flow is free from the threaded end to tubing connection end.
 - The air flow is controlled from the tubing connection end to the threaded end.



- Select the different control method according to the actual requirement. The meter-out type is the first priority.

2.1. The application example of the meter-out speed controller

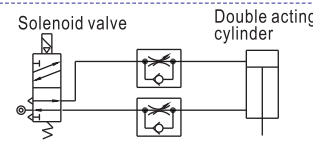

Meter-out speed controller

2.2. The application example of the meter-in speed controller

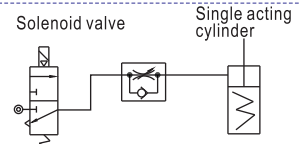

Meter-in speed controller

Installation

- Installation and removal of tubing:

1.1. Installation of tubing

Grasp the tubing and slowly push it into the fitting until it comes to a stop. The tubing will be locked by the spring gasket.

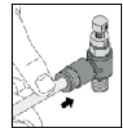

1.2. Removal of tubing

Push the release button to open the spring gasket so that the tubing can be released.

Note: When remove the tubing, make sure the pressure in the tubing is Zero.

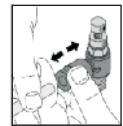

- Mounting of the speed controller

Mount the speed controller into the inlet and outlet port of the cylinder with a wrench.

Note: Please refer to the fittings for the tightening torque and thread screw-in depth.

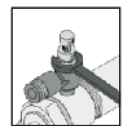

Operation

- Adjustment of the cylinder speed

1.1. Make sure the speed controller is turned off before applying air pressure. The cylinder may fly out due to the high speed if the air is inlet when the speed controller is turned on.

1.2. Adjust the speed by opening the needle slowly from the fully closed state. When a needle valve is turned clockwise, the air flow through is reduced and the actuator speed decreases. When a needle valve is turned counter-clockwise, the air flow through is increased and the actuator speed increases.

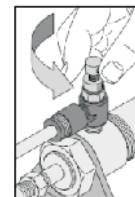
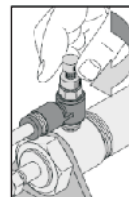

- Operation of the speed controller

2.1. Do not use tools such as pliers to rotate the handle. Do not apply excessive force or shock when the needle is at the place of top or bottom. It can cause damage or air leakage.

2.2. A certain amount of leakage is allowed in the closed state of the speed controller. It is not designed for the use as stop valve with zero air leakage.



Speed controller