

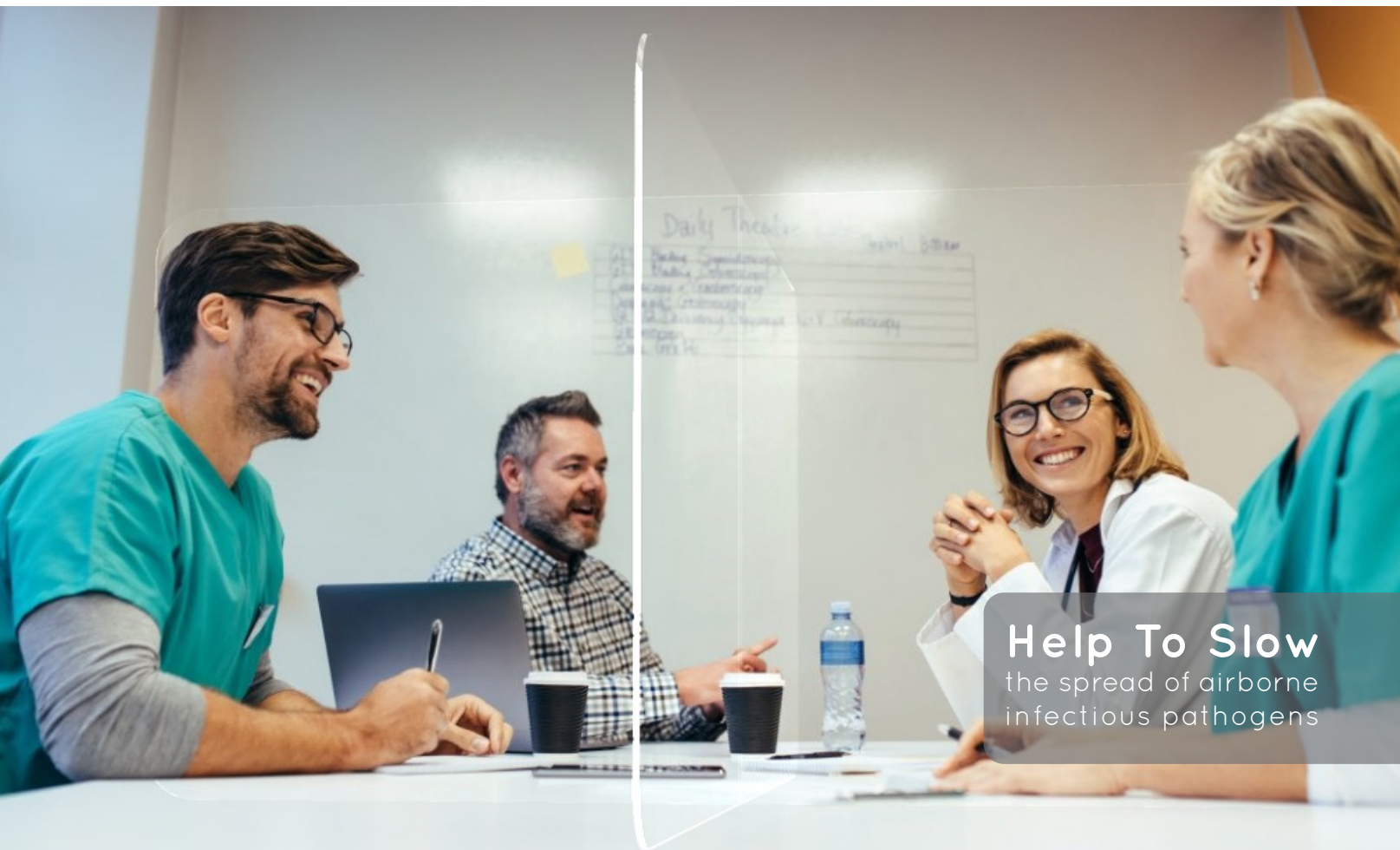

SCREENS & GUARDS

COUGHS AND SNEEZES SPREAD DISEASES!



Help To Slow
the spread of airborne
infectious pathogens

SYLEX
ergonomics

www.sylex.com

Show you care for the wellbeing of staff, visitors and customers by installing these tough Acrylic barriers.

Physical barriers when used in conjunction with other sensible strategies like hand hygiene, distancing where possible and mask wearing can help to slow the spread of airborne infectious pathogens. They serve as a visual reminder to practice prudent prevention.

We use commercial quality clear acrylic, it is the ideal material for desktop or countertop screening, less brittle than glass, more scratch resistant and rigid than PETG and optically clear to aid visual communication while offering protection and peace of mind. We use a translucent dual layer Polycarbonate where some privacy is preferred.

- ▶ Quick to assemble without tools
- ▶ Crystal clear optics
- ▶ Easy to clean, easy to maintain
- ▶ Easy to sanitise
- ▶ Flat packed, with protective film in place (simply peel off)
- ▶ Rounded corners
- ▶ Flame polished edges
- ▶ Tough commercial grade acrylic
- ▶ Shatter-resistant
- ▶ Scratch-resistant

Speak with a specialist today about a custom solution tailored to your corporate or office setting.

Most of these products are in stock and ready to ship now.

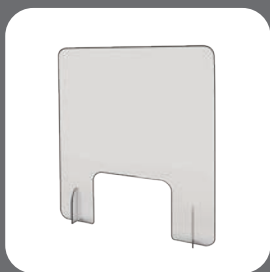

Lookout Sneeze Guards



4 Way Acrylic Dividers

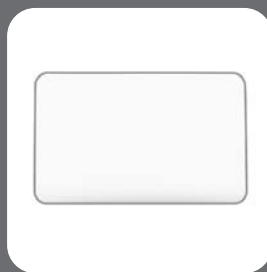

Interdesk Acrylic Screens



Ice Screens



E-Screen

Note Screens and guards cannot prevent you from contracting diseases but may form part of a sensible strategy in reducing risks in workplaces and premises where social distancing is not a viable option.

SYLEX
ergonomics

www.sylex.com

NSW

A | 4-6 Bentley Street, Wetherill Park, NSW 2164
P | 02 9756 4988
F | 02 9756 4991
E | info@sylex.com

VIC

A | 3/152-154 Bangholme Road, Dandenong South VIC 3175
P | 03 9587 8628
F | 03 9587 8691
E | vic2sales@sylex.com

QLD

A | 4/272 Lavarack Avenue, Eagle Farm QLD 4009
P | 07 3260 2060
F | 07 3260 2070
E | john@sylex.com

WA

A | 3 Pusey Road, Cockburn Central, WA 6164
P | 08 9417 4007
F | 08 9417 4009
E | wa1sales@sylex.com

NZ

A | 15/180 Montgomerie Road, Airport Oaks, Auckland 2154
P | (+64) 9 273 0147
F | (+64) 9 273 0145
E | admin@sylex.co.nz

INTERDESK ACRYLIC SCREENS

The move towards collaborative and compact team based desking has been relentless over the last few years, but that same closeness is now being seen as a liability. People are nervous about being too close. Interdesk screens provide a sensible and easy solution to getting your team back to work. They provide a physical barrier but still retain peripheral visual contact. They also act as a reminder to not share equipment and allow workers to feel more at ease in the new workplace. Rounded corners and smoothed edges make this a safe choice. They come in robust 8mm thickness and are sturdy enough to be free-standing with only a single clamp for support. They are 500 mm high and come in three common desk depths, 600, 700 and 800mm or can be customised to suit.

Product codes & dimensions:

FDACR0605 8 x 500(h) x 600(w)

FDACR0705 8 x 500(h) x 700(w)

FDACR0805 8 x 500(h) x 800(w)

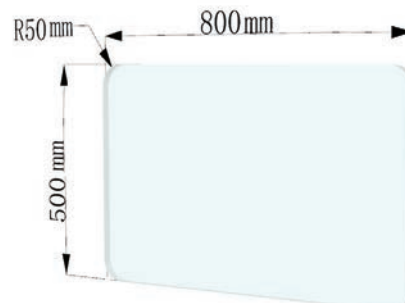
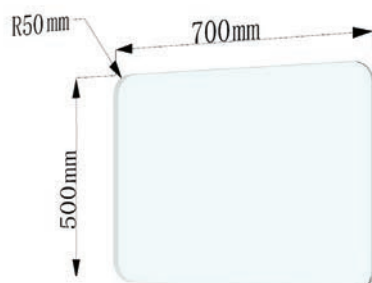
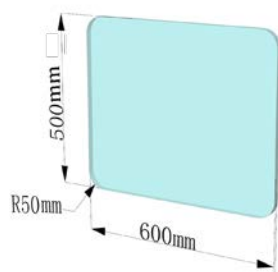



DESK MOUNT CLAMP

Fixed

To mount our Interdesk screens we offer compact desk-mounted clamps. Easy to fit and easy to adjust to securely hold your Acrylic screen in place. Available in silver. Desktop mount requires screwing to desk ; one per 500mm in length (min 2)

Product Code: FDPETCLAWH



GOLF CLAMP

Removable

Fore! Sure it looks like a tiny golf club, but it's unlikely to improve your game. However it is highly likely to improve your working space and peace of mind. The clamp mounts to the front edge of your desk to mount a screen to provide a barrier between you and your workmates in a shared desking set-up. Removeable/ relocatable. Golf clamp to the edge of the desk, one required

Product Code: AWMGCLAWH





4 WAY ACRYLIC DIVIDERS

Together but separate

This simple screen set is free standing and turns a 4 sided table into individual pods. Comes with rounded corners and smooth edges. These two panels simply slot together and sit on a desktop or tabletop. Each panel measures 5mm thick x 600mm high x 1200mm wide. Ideal for offices, schools, libraries, or any place people meet to talk. Allow people to collaborate, not contaminate. Makes pods 600mm x 600mm.

Product Code & Dimensions:

FDACR1212 5 x 500(h) x 1200(w) Each panel

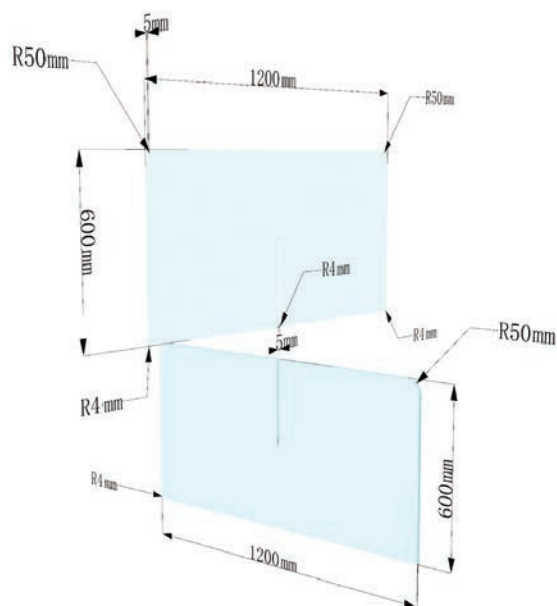

PARTITION TOPPERS

Extend your partitions upwards with custom acrylic barriers. Using unique mounting brackets we can increase the height of your existing cloth partitions by adding an upper layer of acrylic to maintain the current sight lines in the office while reducing concerns. Sizes to order and available to suit a range of cloth partition thicknesses. One mount per 500mm in length (min 2).

Product Code:

FDCLMNS

MOUNTING
BRACKET





LOOKOUT SNEEZEGUARDS

For face to face interactions

Simply breathing and speaking can expel droplets which may contain contagious diseases, singing and shouting even more so. However the real champions at spreading diseases are coughs (up to 3000 droplets) and sneezes (upwards of 100,000 droplets).

Lookout SneezeGuards are made of 5mm crystal clear acrylic and are designed for face to face interaction and to limit contact. They simply slot together and sit on the desktop, no assembly or installation required.



Product Code & Dimensions:

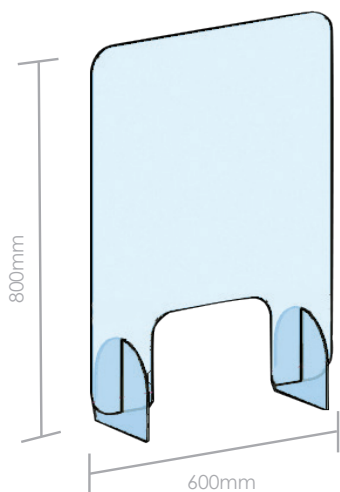

Small:
FDSNG0608CL
600 (w) x 800(h)

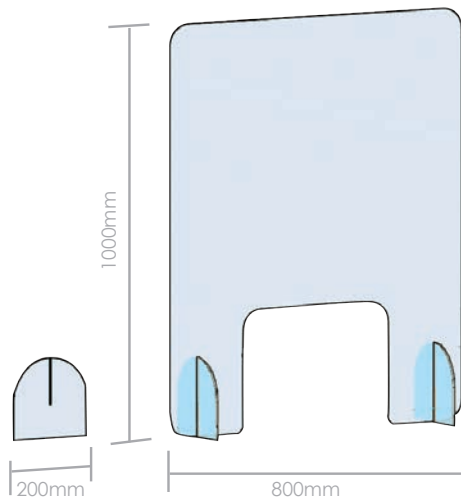
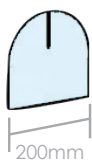

Large:
FDSNG0810CL
800 (w) x 1000(h)





ICE SCREENS

Made from double layer translucent polycarbonate these screens are lightweight, simple to install and look great. They afford some privacy as well as being a cough barrier between workers.

Fully framed in aluminium they add a professional and more permanent look to the office. There are a range of permanent and temporary fixing alternatives to suit and desk or table top.

Icescreens provide the right balance between social distancing, privacy and team collaboration. Simple to install and simple to keep clean.

A wide range of standard sizes is available, including:

- 800(w) x 500(h) generally used at the side of a desk
- 900(w) x 500(h) generally used at the side of a desk
- 1200(w) x 500(h) generally used at the back of a desk
- 1400(w) x 500(h) generally used at the back of a desk
- 1500(w) x 500(h) generally used at the back of a desk
- 1600(w) x 500(h) generally used at the back of a desk
- 1800(w) x 500(h) generally used at the back of a desk

Custom sizes can also be made on lead times.

Product Code & Dimensions:

CODE	DESCRIPTION	WIDTH (mm)
FDICE0805	ICESCREEN TO SUIT SIDE DESK	800
FDICE0905	ICESCREEN TO SUIT SIDE DESK	900
FDICE1205	ICESCREEN TO SUIT BACK DESK	1200
FDICE1405	ICESCREEN TO SUIT BACK DESK	1400
FDICE1505	ICESCREEN TO SUIT BACK DESK	1500
FDICE1605	ICESCREEN TO SUIT BACK DESK	1600
FDICE1805	ICESCREEN TO SUIT BACK DESK	1800

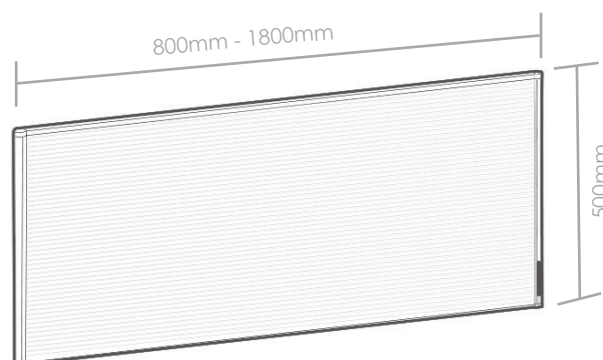



FIXINGS FOR ICE SCREENS

We have a range of mounts which can provide quick temporary or more permanent solutions:

A ICESCREEN HEAVY DUTY CLAMP 2 per screen

This desk clamp is a heavy duty fitting solution which is clamped and tightened at the edge of any desk. Expandable to fit desks/desk frames up to 95mm.

B ICESCREEN COMPACT CLAMP 2 per screen

Compact Clamp fits between two opposing desks to situate a screen in the centre. Fit desk edges up to 45mm.

C ICESCREEN SCREW-DOWN MOUNTING PIN Requires screwing to the desk

Mounted Pin can be placed at any point on the surface of a desk to mount selected screens. 2 Mountingpins are needed to hold the 1 screen and are fixed with screws.

D ICESCREEN HAMMER IN MOUNTING PIN Requires nailing through the desk

Pin is designed to penetrate through a desk top. This solution becomes completely hidden under the selected screen.

Product Code & Dimensions:

A: EDCLAMP

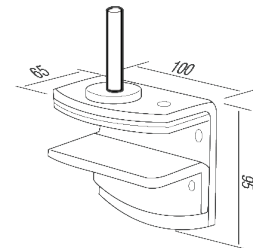

B: FIWCLAMP

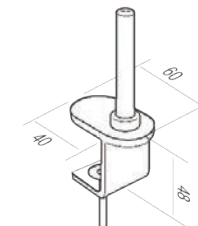

C: EDPIN

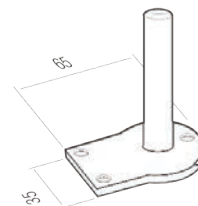

D: FIWPIN



E-SCREEN FULL-HEIGHT FLOOR MOUNTED

Acrylic Screens - Made To Order

Fully separate desks or traffic areas while maintaining sight lines within the office. Using a robust aluminium frame and a choice of mobile or fixed feet these screens are shatter resistant and easy to keep clean. They are also effective in noise reduction.

Product Code & Dimensions:

They can be jointed together to form 2 , 3 and even 4 way connections.

Sizes to order.

Product Code: EFSFACRNS

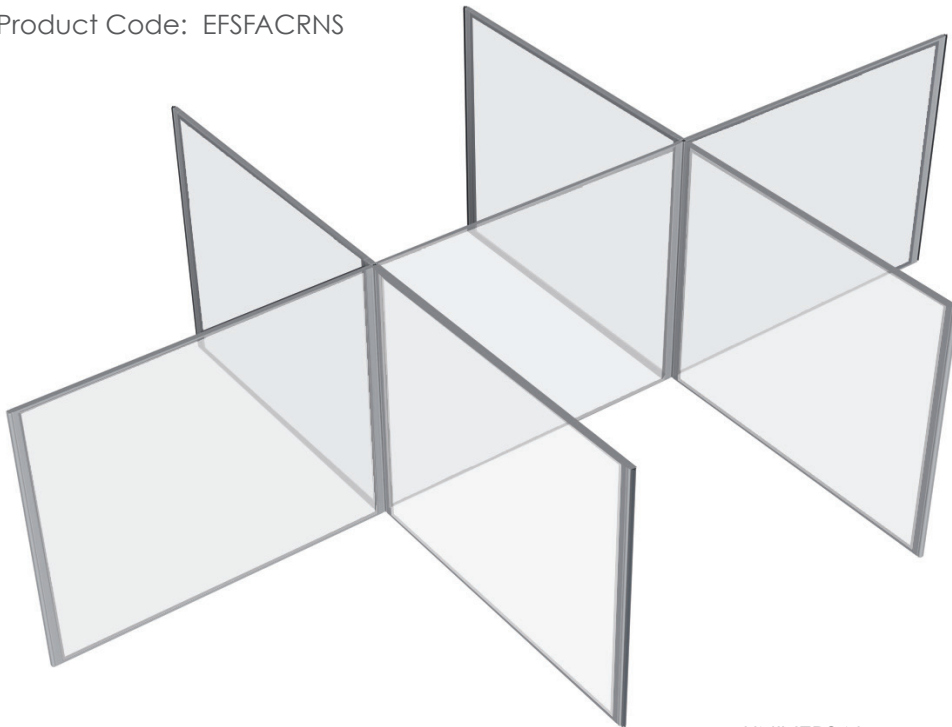

*Can also be specified as half-glazed with a fabric covered lower section

UNIVERSAL JOINING POST



OFFICE CONFIGURATIONS

Users can quickly and simply remove the universal joining post and change the configurations of their screens. Because there is only one basic universal joining post, you can change the entire layout of your office without needing extra parts or expert help. Join 2 way, 3 way or 4 way at any right angle all with the same joiner.

Each floor screen comes with the universal joiner at one end. There is no need to specify or lock into a particular configuration.

As soon as you create a 90 degree corner e-screens become stable and freestanding, for creating long straight runs we recommend either a small 'return' piece or bracing to existing furniture with optional brackets. e-SCREENS are slightly elevated with an adjustable glide allowing for height adjustments in out of level floors and to create a cable pass-through.



1 WAY



2 WAY



3 WAY



4 WAY

E-SCREEN MOBILE LEGS

With Castors

E-SCREENS MOBILE are suitable for creating partitions for your work space. The product is designed for a constantly changing environment to provide order, privacy and versatility.

Product Code & Dimensions:

Width: 900mm -1200mm
Height: 1500mm -1800mm
Product Code: EFSFACRNS



E-SCREEN FLAT OVAL FOOT

Flat oval foot can be fitted under floor screens to provide further stability or to make a single screen free standing.







Product Code: ESFOOT



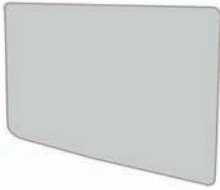



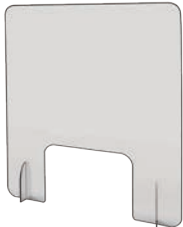

Show you care for the wellbeing of staff, visitors and customers by installing these tough Acrylic barriers.

We use commercial quality clear Acrylic, it is the ideal material for desktop or countertop screening, less brittle than glass, more scratch resistant and rigid than PETG and optically clear to aid visual communication while offering protection and peace of mind.

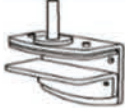
We use translucent dual layer Polycarbonate where some privacy is preferred.

Category	Image	Part number	Description
Interdesk Acrylic Screens		FDACR0605	ACRYLIC SCREEN 600 x 500 x 8 (mm) CLEAR
		FDACR0705	ACRYLIC SCREEN 700 x 500 x 8 (mm) CLEAR
		FDACR0805	ACRYLIC SCREEN 800 x 500 x 8 (mm) CLEAR
		FDACRNS	CUSTOM ACRYLIC INTERDESK SCREENS TO ORDER
		AWMGCLAWH	GOLF CLAMP REMOVEABLE
	FDPETCLAWH	DESK MOUNT CLAMP FIXED	
4 Way Acrylic Dividers		FDACR1212	ACRYLIC SCREEN 1200 x 1200 x 5 (mm) CLEAR, 2 PIECE
Partition Toppers		FDACRNS	CUSTOM DESIGNED TO ADD ON TO A RANGE OF PARTITIONS
		FDCLMNS	PARTITION MOUNT CLAMP REMOVEABLE
Lookout Sneeze Guards		FDSNG0608CL	SNEEZE GUARD 600 x 800H (mm) CLEAR
		FDSNG0810CL	SNEEZE GUARD 800 x 1000H (mm) CLEAR

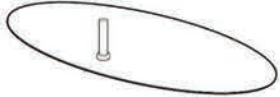
Note Screens and guards cannot prevent you from contracting diseases but may form part of a sensible strategy in reducing risks in workplaces and premises where social distancing is not a viable option.

Category	Image	Part number	Description			
Ice Screens		FDICE0805	FRAMED POLYCARBONATE SCREEN 800(W) X 500(H)			
		FDICE0905	FRAMED POLYCARBONATE SCREEN 900(W) X 500(H)			
		FDICE1205	FRAMED POLYCARBONATE SCREEN 1200(W) X 500(H)			
		FDICE1405	FRAMED POLYCARBONATE SCREEN 1400(W) X 500(H)			
		FDICE1505	FRAMED POLYCARBONATE SCREEN 1500(W) X 500(H)			
Ice Screens		EDCLAMP	ICESCREEN HEAVY DUTY CLAMP			
			FIWCLAMP	ICESCREEN COMPACT CLAMP		
				EDPIN	ICESCREEN SCREW-DOWN MOUNTING PIN	
					FIWPIN	ICESCREEN HAMMER IN MOUNTING PIN
					E-screen Full height framed Acrylic Screens	
	ESFOOT					
		ESMBBEAM				
			ESJOINER			