

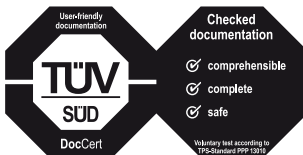

## The IMPRESSA Z5 – Generation II Manual



The 'IMPRESSA Manual' has been awarded the seal of approval by the independent German Technical Inspection Agency, TÜV SÜD, due to its easy-to-understand style, its thoroughness and coverage of safety aspects.

# Your IMPRESSA Z5

IMPORTANT SAFEGUARDS	4
Control elements and accessories	8
Proper use	10
For your safety	10
The IMPRESSA Z5 Manual	13
Model variants.....	14
Symbol description.....	14
Welcome to the world of IMPRESSA!	15
1 IMPRESSA Z5 – ‘Two at once’	16
JURA on the Internet.....	17
2 Preparing and using for the first time	18
Supplied as standard.....	18
Setting up.....	18
Filling the water tank.....	18
Filling the bean container.....	19
First-time use.....	19
Using and activating filter.....	21
Assessing and setting water hardness.....	22
Adjusting grinder.....	23
Switching on.....	24
Switching off (Standby).....	25
3 Familiarising yourself with the control options	26
Preparation at the touch of a button.....	26
One-off setting before and during preparation.....	27
Entering a permanent setting for the amount of water for a cup size.....	28
Permanent settings in programming mode.....	29
View information and care status.....	32
4 Recipes	34
5 Preparation at the touch of a button	40
Barista tips.....	40
Ristretto.....	41
Espresso.....	42
Coffee.....	42
Special coffee.....	42
Cappuccino.....	42
Latte macchiato.....	43

Pre-ground coffee .....	45
Hot milk .....	46
Hot water .....	46
<b>6 Permanent settings in Programming mode</b>	<b>48</b>
Products.....	48
Energy-save mode .....	51
Time and weekday.....	52
Programmable Switch-on time .....	53
Automatic switch-off.....	54
Rinses .....	55
Unit amount of water/time format .....	56
Logo.....	57
Language .....	58
Rename.....	58
<b>7 Maintenance</b>	<b>60</b>
Maintenance tips.....	60
Rinse machine.....	60
Changing the filter .....	61
Clean machine .....	63
Descal machine .....	65
Rinsing the cappuccino nozzle .....	68
Cleaning the cappuccino nozzle.....	68
Dismantling and rinsing the cappuccino nozzle.....	70
Removing foreign objects .....	70
Cleaning the bean container.....	70
Descaling the water tank.....	71
<b>8 CLARIS plus filter cartridge – Water for perfect coffee</b>	<b>73</b>
<b>9 ‘The milk makes the difference’</b>	<b>81</b>
<b>10 Accessories and Service</b>	<b>82</b>
<b>11 Display messages</b>	<b>91</b>
<b>12 Troubleshooting</b>	<b>94</b>
<b>13 Transport and environmentally neutral disposal</b>	<b>96</b>
Transport / Empty system .....	96
Disposal.....	96
<b>14 Technical data</b>	<b>97</b>
<b>15 Key technologies and products</b>	<b>100</b>
<b>16 JURA contact details</b>	<b>105</b>
Index	110

# IMPORTANT SAFEGUARDS

These safeguards apply for machines with UL safety test (see rating plate and chapter 14, 'Technical data').

## **Follow the basic safety precautions**

When using electrical appliances, basic safety precautions should always be followed, to reduce the risk of fire, electric shock, and/or injury to persons, including the following:

- Read all instructions.
- Do not touch hot surfaces. Use handles or knobs.
- To protect against fire, electric shock and injury to persons, do not immerse cord, plugs, or body of machine in water or other liquid.
- Close supervision is necessary when any appliance is used by or near children.
- Unplug from outlet when not in use and before cleaning. Allow to cool before putting or taking off parts, and before cleaning the appliance.
- Do not operate any appliance with a damaged cord or plug or after the appliance malfunctions, or has been damaged in any manner. Return appliance to the nearest authorized service facility for examination, repair or adjustment.
- The use of accessory attachment not recommended by the appliance manufacturer may result in fire, electric shock, or injury to persons.
- Do not use outdoors.
- Do not let the cord hang over the edge of a table or counter, or touch hot surfaces.
- Do not place on or near a hot gas or electric burner, or in a heated oven.
- Always attach plug to appliance first, then plug cord into the wall outlet. To disconnect, turn any control to 'OFF' then remove plug from wall outlet.
- Do not use appliance for other than intended use.
- Use extreme caution when dispensing hot steam.
- For household use only.

## **SAVE THESE INSTRUCTIONS**

**Special cord set instructions**

- a. A short power supply cord is provided to reduce the risk resulting from becoming entangled in or tripping over a long cord.  
Your IMPRESSA has a 3-pin grounded plug.
  - b. Longer extension cords are available and may be used if care is exercised in their use.
  - c. If an extension cord is used,
    - 1. the marked electrical rating of the extension cord should be at least as great as the electrical rating of the appliance, and
    - 2. if the appliance is of the grounded type, the extension cord should be a grounding type 3-wire cord, and
    - 3. the longer cord shall be arranged so that it will not drape over the counter top or tabletop where it can be pulled on by children or tripped over.
- As a safety feature, this plug will fit in a polarized outlet only one way.
  - If the plug does not fit fully in the outlet, reverse the plug. If it still does not fit, contact a qualified electrician.
  - Do not modify the plug in any way or attempt to defeat this safety feature.

**Warning**

To reduce the risk of fire or electric shock, do not remove any service covers. No user serviceable parts inside. Repair should be done by authorized personnel only.

**Caution**

This appliance is for household use. Any servicing other than cleaning and user maintenance should be performed by an authorized service representative:

- Do not immerse base in water or try to disassemble.
- To reduce the risk of fire or electric shock, do not remove the base. No user serviceable parts inside. Repair should be done by authorized service personnel only.
- Check voltage to be sure that the voltage indicated on the name plate agrees with your voltage.
- Never use warm or hot water to fill the water container! Use cold water only.

## Important Safeguards

### **NEVER DO (or you will void your warranty protection):**

- Keep your hands and the cord away from hot parts of the appliance during operation.
- Never clean with scouring powders or hard implements.
  
- Never fill instant coffee, chocolate mix etc. into the grinder or ground coffee funnel (grinder by-pass). It will damage the functioning of the brewing chamber.
- Never fill sugar coated coffee beans into the bean hopper. In case of doubt, call your dealer.
- Never fill anything other than coffee beans into the bean container (no chocolate, no rice, no nuts, no spices, nothing other than roasted coffee beans).
- Never do anything with the machine which is not described in the User's Manual. In case of doubt, call your dealer.



## Control elements and accessories

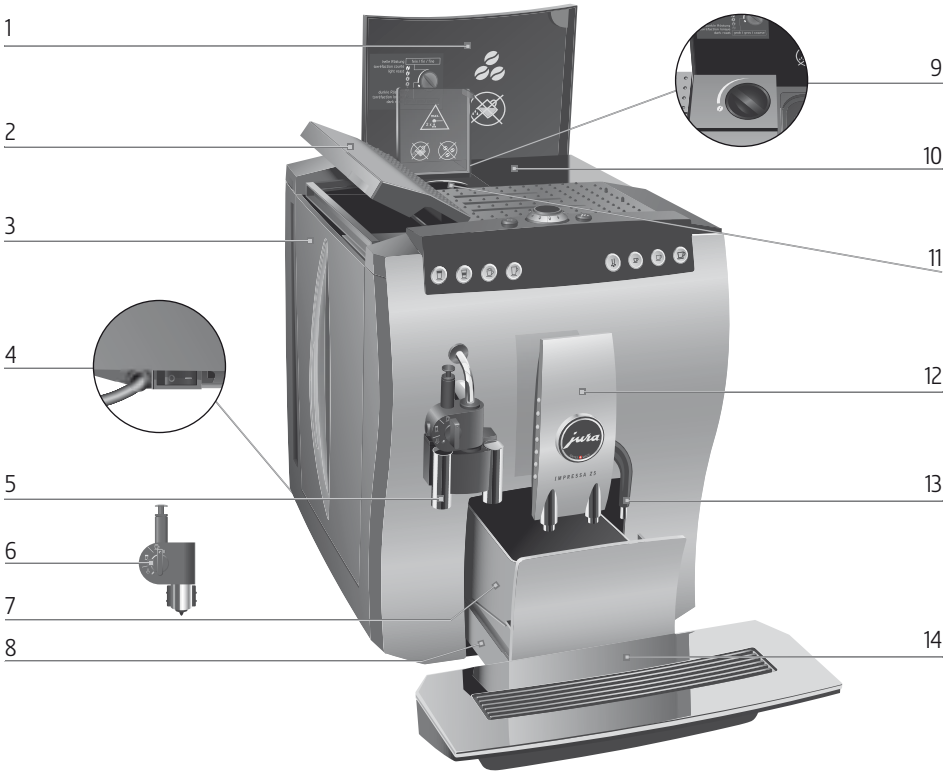
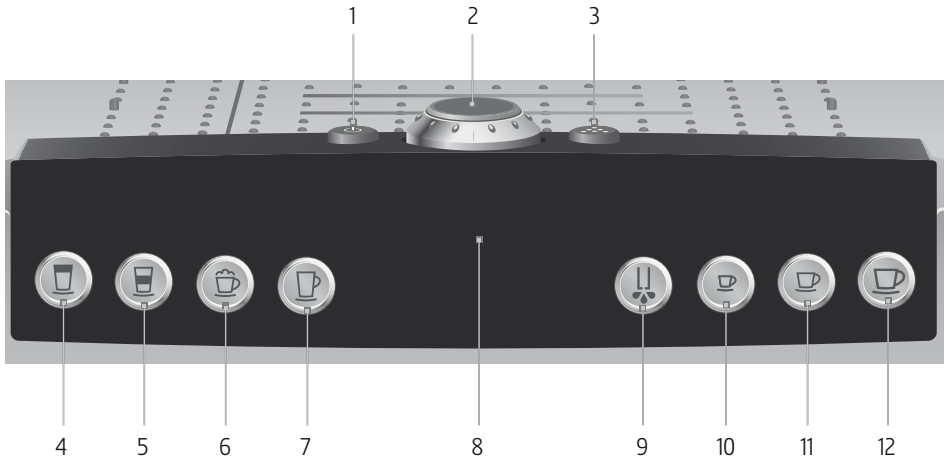





Figure: IMPRESSA Z5 – Generation II Alu

- |   |  |    |  |
|---|--|----|--|
| 1 | Bean container cover                     | 9  | Grinding wheel                               |
| 2 | Water tank cover                         | 10 | Bean container with aroma preservation cover |
| 3 | Water tank                               | 11 | Filler funnel for pre-ground coffee          |
| 4 | Power switch and power cable (side)      | 12 | Height-adjustable coffee spout               |
| 5 | One Touch Cappuccino nozzle, long spout  | 13 | Hot water spout                              |
| 6 | One Touch Cappuccino nozzle, short spout | 14 | Cup platform                                 |
| 7 | Coffee grounds container                 |    |  |
| 8 | Drip tray                                |    |  |





Top of the machine

- 1  On/off button
- 2  Rotary Switch
- 3  Maintenance button

Front

- 4  Milk button
- 5  Latte macchiato button
- 6  Cappuccino button
- 7  Special Coffee button
- 8  Display
- 9  Hot water button
- 10  Ristretto button
- 11  Espresso button
- 12  Coffee button

## Proper use

The machine has been designed and built for domestic use. It should only be used to prepare coffee and to heat milk and water. Use for any other purpose will be deemed improper. JURA cannot accept any responsibility for the consequences of improper use.

Keep this manual close to the IMPRESSA and, if appropriate, pass it on to the next user.

## For your safety



Please read and note carefully the following important safety information.

By doing this, you can avoid the life-threatening danger of electric shock:

- Never use a machine which has been damaged or with a defective power cable.
- For information on what to do in case of damage, for example if there is a smell of burning, unplug the machine immediately from the mains supply and contact the JURA service centre.
- If the power cable for this machine is damaged, it must be repaired either directly by JURA or by a JURA approved service centre.
- Make sure that the IMPRESSA and the power cable are not located close to hot surfaces.
- Be careful to ensure that the power cable does not get caught and does not rub against sharp edges.
- Never open and repair the machine yourself. Do not modify the machine in any way that is not described in the IMPRESSA Manual. The machine contains live parts. If opened, there is a danger of serious injury. Repairs may only be carried out by JURA approved service centres, using original spare parts and accessories.

There is a risk of scalds or burns on the spouts or in the nozzle:

- Place the machine out of the reach of children.
- Do not touch any hot parts. Use the handles provided.

- Be careful to ensure that the appropriate nozzle is installed and clean. The nozzle or parts of the nozzle might come off if the parts are not assembled correctly or a blockage occurs.

A defective machine is not safe and could cause injury or fire. To avoid damage and any associated risk of injury or fire:

- Never allow the power cable to loosely hang down. The power cable can be tripped over or damaged.
- Protect your IMPRESSA from environmental influences such as rain, frost and direct sunlight.
- Do not put the IMPRESSA, cable or connections in water.
- Do not put the IMPRESSA or any individual parts in the dishwasher.
- Turn your IMPRESSA off at the power switch before starting any cleaning operation. Always wipe your IMPRESSA with a damp cloth rather than a wet one, and protect it from prolonged water splash.
- Only connect the machine to a power supply in accordance with the technical data (see rating plate and Chapter 14, 'Technical data').
- Use only original JURA care products. Use of accessories that are not explicitly recommended by JURA could damage the IMPRESSA.
- Do not use any coffee beans treated with additives or caramelised coffee beans.
- Always fill the water tank with cold, fresh mains water.
- If you will be absent for an extended period, turn the machine off and unplug.

Risk to children and persons with limited capabilities in operating machines:

- The machine is not designed to be operated by children and persons with limited capabilities.
- The machine may only be used by persons who are able to operate the machine safely.

## Important information

Safe handling of the CLARIS plus filter cartridges:

- CLARIS plus filter cartridges should be kept out of the reach of children.
- Store them dry in the sealed package.
- Protect them from heat and direct sunlight.
- Do NOT use damaged CLARIS plus filter cartridges.
- Do NOT open CLARIS filter cartridges.

## The IMPRESSA Z5 Manual

You are holding the manual for your IMPRESSA Z5 in your hand. It will help you to familiarize yourself with your IMPRESSA safely and quickly and teach you the full range of facilities it offers.

Chapter 2, 'Preparing and using your IMPRESSA for the first time', explains step-by-step how to set up and prepare the IMPRESSA.

Chapter 3, 'Familiarising yourself with the control options' is important for you to read as you are familiarising yourself with your IMPRESSA. It invites you to actively explore all the different coffee experiences that it offers.

As coffee and coffee specialities are very important to JURA, we have compiled a selection of tasty suggestions for you in Chapter 4, 'Recipes'.

All the other chapters are intended to help you when you have a specific query.

If you use the IMPRESSA Z5 Manual, you will become a master at preparing exciting coffee specialities, you will be a Barista!

## Model variants

The IMPRESSA Z5 – Generation II Manual covers all Z series IMPRESSA-models.

## Symbol description

### Warnings

---

 <b>CAUTION</b>	Always take note of any information marked with the CAUTION or WARNING symbol. The signal word <b>WARNING</b> points out potential risk of serious injury, and the signal word <b>CAUTION</b> potential risk of slight injury.
<b>CAUTION</b>	The <b>CAUTION</b> symbol is used to draw attention to circumstances which could cause the machine to become damaged.

---

### Symbols used

---

<b>i</b>	<b>Information</b> and tips to make things easier for you as you use your IMPRESSA.
@	References to the <b>online</b> JURA website, where you can find interesting further information: <a href="http://www.jura.com">www.jura.com</a>
▶	<b>Prompt to take action.</b> This symbol means that you are being prompted to perform some action.

---

## Welcome to the world of IMPRESSA!

Dear customer,

We thank you for the trust that you have placed in us by purchasing a JURA IMPRESSA coffee machine. The machines, which are produced in Switzerland, have already impressed independent, critical testers of goods and design award juries. We will do everything we can to ensure that this fully automated, genuine 2-cup Espresso and coffee machine continues to deliver perfect coffee specialities at the press of a button to your family and your guests for years to come.

The IMPRESSA Manual will teach you everything you need to know on the subject of operating and tailoring your IMPRESSA to your particular preferences. Other subjects covered include how to solve the problem of scale build-up and important tips on care. Our primary concern is to stimulate your imagination with attractive coffee recipes and to invite you to put the wealth of possibilities offered by the JURA fully automated machine to use on a daily basis.

We wish you many stimulating and enjoyable moments with your IMPRESSA.

Yours sincerely,

A handwritten signature in black ink, consisting of a stylized first name and a last name.

Emanuel Probst  
General Manager

## 1 IMPRESSA Z5 – ‘Two at once’

### Coffee that fulfils your wildest dreams

Coffee specialities are extremely popular. An increasing number of perfect hosts treat themselves, friends and families to a wide range of coffee specialities in the comfort of their own homes. Milk is a very important ingredient of a perfect cup of coffee, both foamed and heated, as cappuccino, latte macchiato, and caffè latte, also enhanced with different flavours, are now firm favourites on the almost inexhaustible and varied list of coffee recipes alongside alongside the classic ristretto, espresso and café crème.

JURA has now developed the second generation of the revolutionary IMPRESSA Z line to satisfy the high demands of the growing community of speciality gourmets.

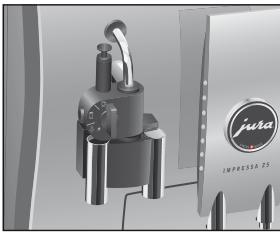

- **One Touch Cappuccino nozzle:** The machines of the IMPRESSA Z line, which are in the truest sense fully-automatic coffee speciality machines, can prepare two treats for the eye and palate at the touch of a button with the One Touch cappuccino nozzle. ‘Two at once’ – the quickest, most direct and simple way to delve into the world of coffee and to revel in all its variety.

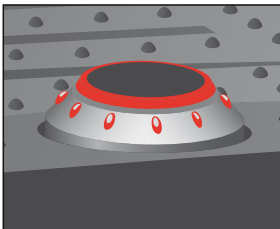

- **Rotary Switch – Intuitive operation:** You can ‘navigate’ reliably through all operating and programming steps by simply turning and pressing the switch. The information on the plain text and graphic display is in full view at all times. The focus is fully on your own personal taste. Simply select the coffee strength, amount of water and temperature according to your individual preferences.



- **Stainless steel vacuum milk container:** Your fully-automatic coffee machine is equipped as standard with a vacuum milk container which keeps the milk cool all day due to its clever design.



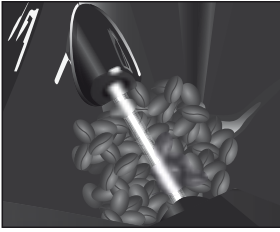

- **Active bean monitoring:** The IMPRESSA Z5 banishes the sound of empty rotating coffee grinders and half-full cups once and for all. It always shows you when the coffee beans need replenishing in good time. The filling level of the bean container is continuously monitored optically.

## JURA on the Internet

Visit us on the Internet.

- @ At [www.jura.com](http://www.jura.com) you will find interesting and up-to-date information on your IMPRESSA and on every aspect of coffee.

## Knowledge Builder

You can familiarize yourself with your IMPRESSA Z5 in a fun way on the PC.

- @ The Knowledge Builder awaits you at [www.jura.com](http://www.jura.com). The interactive assistant, LEO, will assist you and explain the benefits of the IMPRESSA and how to use it.

## 2 Preparing and using for the first time

This chapter provides you with the information you need to use your IMPRESSA without any problems. You will prepare your IMPRESSA step-by-step for your first coffee experience.

### Supplied as standard

The following items are supplied as standard:

- Your JURA IMPRESSA fully automatic coffee machine
- Stainless steel vacuum milk container
- Milk pipe
- The Welcome Pack, which includes:
  - The IMPRESSA Z5 – Generation II Manual
  - IMPRESSA Z5 – Generation II: Quick Reference Guide
  - CLARIS plus filter cartridge (2x)
  - Filter cartridge extension
  - Grinder key
  - Measuring spoon for pre-ground coffee
  - JURA cleaning tablets
  - Aquadur® test strips
- JURA Auto-Cappuccino Cleaner
- JURAWorld of Coffee gift

Keep the packaging of your IMPRESSA. It should be used to protect the machine during transportation.

### Setting up

When setting up your IMPRESSA, please note the following:

- Set the IMPRESSA down on a horizontal surface that is not sensitive to water.
- Choose a spot for your IMPRESSA which is protected against overheating.

### Filling the water tank

To enjoy perfect coffee we recommend changing the the water every day.

- i** Only use fresh, cold water to refill the water tank and never milk, mineral water or other liquids.

- ▶ Remove the water tank and rinse it with cold water.
- ▶ Fill the water tank with fresh, cold mains water and reinsert.

## Filling the bean container

### CAUTION

The bean container has an aroma preservation cover. This will ensure that your coffee beans retain their aroma for longer.

---

Coffee beans which have been treated with additives (e.g. sugar), pre-ground or freeze-dried coffee will damage the grinder.

- ▶ Only use untreated coffee beans to refill the bean container.
- 
- ▶ Open the cover of the bean container and remove the aroma preservation cover.
  - ▶ Remove any dirt or foreign objects inside the bean container.
  - ▶ New machines contain an information sheet in the bean container. Remove this information sheet.
  - ▶ Fill the bean container with coffee beans, then close the aroma preservation cover and the bean container cover.

## First-time use



### WARNING

---

If the machine is operated with a defective power cable, there is a danger of electric shock.

- ▶ Never use a machine which has a defective power cable.
- 

**Precondition:** The water tank and bean container are full.

- ▶ Insert the mains plug into a power socket.
- ▶ Switch on the IMPRESSA using the power switch on the left side of the machine.  
The On/Off button  lights up (standby).
- ▶ Press the On/Off button to switch the IMPRESSA on.  
The Rotary Switch lights up. **SFRACHE DEUTSCH** is displayed.
- ▶ Turn the Rotary Switch until the desired language is displayed. For example **LANGUAGE ENGLISH**.

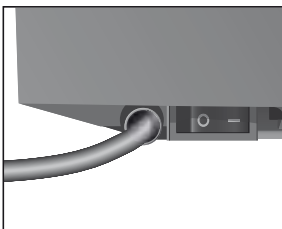

## 2 Preparing and using your IMPRESSA for the first time

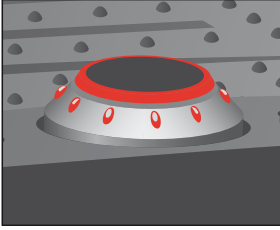

- ▶ Press the Rotary Switch to confirm the language.  
CONFIRMED ✓ appears briefly on the display to confirm the setting.  
TIME HOURS ---:--
- ▶ Turn the Rotary Switch to set the hour.  
TIME HOURS 12:00 (Example)
- ▶ Press the Rotary Switch to confirm the hour setting.  
TIME MINUTES 12:00
- ▶ Turn the Rotary Switch to set the minutes.  
TIME MINUTES 12:45 (Example)
- ▶ Press the Rotary Switch to confirm the minute setting.  
CONFIRMED ✓ appears briefly on the display.  
WEEKDAY MONDAY
- ▶ Turn the Rotary Switch to set the weekday.  
WEEKDAY WEDNESDAY (Example)
- ▶ Press the Rotary Switch to confirm the setting.  
CONFIRMED ✓ appears briefly on the display.



- ▶ Press the maintenance button. ⚡ lights up.
- ▶ Place a receptacle under the hot water spout and below the cappuccino nozzle.
- ▶ Press the maintenance button. ⚡
- ▶ SYSTEM FILLS, the system fills up with water and the maintenance button ⚡ flashes. A small amount of water flows from the cappuccino nozzle and the hot water spout. This operation stops automatically. WELCOME TO JURA appears on the display.



- ▶ UNIT IS HEATING
- ▶ PRESS RINSE, the maintenance button ⚡ lights up.
- ▶ Place a receptacle under the coffee spout.
- ▶ Press the maintenance button. ⚡
- ▶ The machine rinses itself, stopping automatically. COFFEE READY appears on the display. Your IMPRESSA is ready to use.

- ▶ After first-time use do not disconnect the IMPRESSA from the power supply for 24 hours to ensure that it is in the optimum operating condition.

- i** When a coffee speciality has been prepared for the first time, it is possible that **FILL BEANS** appears on the display as the grinder has not yet been completely filled with coffee beans. In this case prepare a different coffee speciality.

## Using and activating filter







Your IMPRESSA no longer has to be descaled if you use the CLARIS plus filter cartridge.

- @ You can also try out the 'Insert filter' operation online. Visit the Knowledge Builder at [www.jura.com](http://www.jura.com).

Further information on the CLARIS plus filter cartridge can be found in Chapter 8, 'CLARIS plus filter cartridge – Water for perfect coffee'.

- i** Perform the 'Insert filter' operation without interruption. This will ensure that your IMPRESSA always produces its best.

**Precondition:** **COFFEE READY** is shown on the display.

-  ▶ Keep the Rotary Switch pressed **until MAINTENANCE** appears on the display.
-  ▶ Turn the Rotary Switch until **FILTER I.F.W.S.** is displayed.
-  ▶ Press the Rotary Switch to enter the programme item.  
**FILTER NO**
-  ▶ Turn the Rotary Switch until **FILTER YES** is displayed.
-  ▶ Press the Rotary Switch to confirm the setting.  
**CONFIRMED ✓** appears briefly on the display to confirm the setting.  
**INSERT FILTER / PRESS BUTTON**, the maintenance button  lights up.
- ▶ Remove a CLARIS plus filter cartridge and the filter cartridge extension from the Welcome Pack.
- ▶ Place the extension on top of the filter cartridge.
- ▶ Remove the water tank and empty it.

## 2 Preparing and using your IMPRESSA for the first time

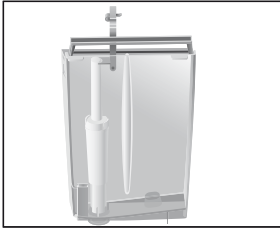

- ▶ Lift the cartridge holder and insert the filter cartridge into the water tank, applying slight pressure.
- ▶ Close the cartridge holder. It will click into place audibly.
- ▶ Fill the water tank with fresh, cold water and reinsert.

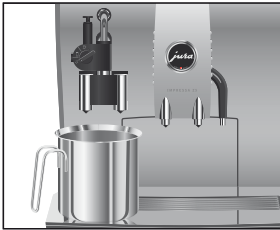

- ▶ Place a receptacle (containing at least 500 ml) under the cappuccino nozzle.
- ▶ Turn the selection lever of the nozzle to the steam position ☼.
- ⚠ ▶ Press the maintenance button.  
**FILTER RINS** ☼, water will flow out of the nozzle.

- i** You can interrupt filter rinsing at any time by pressing any button.
- i** The water may be slightly discoloured. This is not harmful to health and does not affect the taste.

Filter rinsing stops automatically after approx. 500 ml. **COFFEE READY** appears on the display. The filter is now activated.

## Assessing and setting water hardness

The harder the water is, the more frequently the IMPRESSA needs to be descaled. It is therefore important to adjust the water hardness.

The water hardness can be adjusted on a continuous scale between 1° dH and 30° dH. This can also be deactivated, which means that the IMPRESSA will not let you know when it has to be descaled.

- i** However, if you are using the CLARIS plus filter cartridge and have activated it, you will not be able to adjust the water hardness.

You can find out what the water hardness is by using the Aquadur® test strips supplied as standard.

- ▶ Hold the test strip briefly (for one second) under flowing water. Shake off the water.

- ▶ Wait for about one minute.
- ▶ You will then be able to read the degree of water hardness from the discolouration of the Aquadur® test strip and the description on the packaging.  
You can now adjust the water hardness.

**Example:** To change the water hardness from 16° dH to 25° dH, proceed as follows:

**Precondition:** COFFEE READY is shown on the display.

- ⌚ ▶ Keep the Rotary Switch pressed **until** MAINTENANCE appears.
- ⌚ ▶ Turn the Rotary Switch until HARDNESS 16° dH is displayed.
- ⌚ ▶ Press the Rotary Switch to enter the programme item.  
HARDNESS 16° dH
- ⌚ ▶ Turn the Rotary Switch until HARDNESS 25° dH is displayed.
- ⌚ ▶ Press the Rotary Switch to confirm the setting.  
CONFIRMED ✓ appears briefly on the display to confirm the setting.  
HARDNESS 25° dH
- ⌚ ▶ Turn the Rotary Switch until EXIT is displayed.
- ⌚ ▶ Press the Rotary Switch to exit programming mode.  
COFFEE READY is shown on the display.

## Adjusting grinder

You can adjust the grinder to suit the roast of your coffee.

Our recommendations:

- Select a fine setting for a light roast.
- Select a coarse setting for a darker roast.

### CAUTION

If you adjust the fineness of grind when the grinder is not operating, the grinding wheel could be damaged.

- ▶ Only adjust the fineness of grind when the grinder is running.

## 2 Preparing and using your IMPRESSA for the first time

**Example:** To change the fineness of grind **during** coffee preparation, proceed as follows:

- ▶ Open the cover of the bean container.
- ▶ Place a cup under the coffee spout.
- ☞ ▶ Press the Coffee button.  
The grinder starts and **1 COFFEE** appears on the display. After this, the coffee strength is briefly displayed.
- ▶ Turn the grinding wheel to the desired position **while** the grinder is running.  
The coffee will be prepared and the fineness of grind is adjusted.

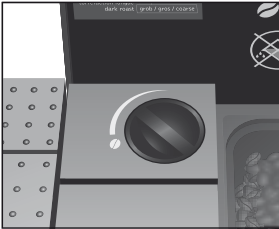

### Switching on

When the IMPRESSA is switched on, a prompt for the rinse operation automatically appears which is initiated by pressing the maintenance button ☼.

This setting can be changed in programming mode so that the machine automatically activates the switch-on rinse (see Chapter 6 'Permanent settings in programming mode – Rinses').

**Precondition:** Your IMPRESSA is switched on at the power switch and the On/Off button ⏻ is illuminated (standby).

- ⏻ ▶ Press the On/Off button to switch the IMPRESSA on.  
**WELCOME TO JURA**  
**UNIT IS HEATING**  
**PRESS RINSE**, the maintenance button ☼ lights up.
- ▶ Place a receptacle under the coffee spout.
- ☼ ▶ Press the maintenance button.  
The machine rinses itself, stopping automatically.  
**COFFEE READY** appears on the display. Your IMPRESSA is ready to use.





## Switching off (Standby)



When you switch your IMPRESSA off, the spouts with which a coffee speciality or milk have been prepared are rinsed.

- ▶ Place a receptacle under the coffee spout and the cappuccino nozzle.
- ☼ ▶ Press the On/Off button.

**i** When you prepare a milk product, but have not performed cappuccino cleaning, **CLEAN MILK SYSTEM** appears and the maintenance button lights up. For ten seconds you can start the ‘Clean cappuccino nozzle’ procedure by pressing the maintenance button ☼.

**GOODBYE** appears on the display, and the coffee spout is rinsed.

**RINSE LEFT SPOUT / PRESS BUTTON.**

- ☼ ▶ Press the maintenance button.  
**GOODBYE** appears on the display, and the left coffee spout is rinsed.  
The IMPRESSA is switched off (standby mode), and the On/Off symbol ☼ lights up.

**i** When your IMPRESSA is switched off, a hissing noise may be audible. This is normal and does not have any effect on the machine.

## 3 Familiarising yourself with the control options

With the IMPRESSA you can prepare an excellent coffee or milk speciality at the touch of a button. You also have the option of adjusting the coffee strength and temperature as well as the amount of water to your personal taste.

This chapter will allow you to become familiar with all control options with the aid of examples. To familiarise yourself with your IMPRESSA, we recommend that you make a point of actively trying the facilities described in this chapter. You will find this is well worthwhile.

Learn how to perform the following:

- Preparation at the touch of a button
- One-off settings **before** and **during** preparation
- Adjusting the permanent amount of water to suit the cup size
- Permanent settings in programming mode

**i** You can stop the machine at any time while a coffee or milk speciality or hot water is being prepared. To do this, press any button.

@ If you prefer to familiarise yourself with your IMPRESSA in a fun way on the computer, the interactive Knowledge Builder tutorial program can be found on the Internet at [www.jura.com](http://www.jura.com).

### Preparation at the touch of a button

Prepare your favourite coffee speciality at the touch of a button.

All coffee specialities are prepared following this model at the touch of a button.

### Preparing a coffee speciality at the touch of a button

**Example:** Proceed as follows to prepare **one** espresso.

**Precondition:** **COFFEE READY** is shown on the display.

- ▶ Place an espresso cup under the coffee spout.
  - ☞ ▶ Press the Espresso button.
    - 1 ESPRESSO** and the coffee strength is displayed.
- The pre-set amount of water flows into the cup and the process stops automatically.
- COFFEE READY** is shown on the display.

### Preparing two coffee specialities at the touch of a button

**Example:** Proceed as follows to prepare **two** espressi.

**Precondition:** **COFFEE READY** is shown on the display.

- ▶ Place two espresso cups under the coffee spout.
  - ☞ ▶ Press the Espresso button twice (**within two seconds**).
    - 2 ESPRESSI**, the pre-set amount of water flows into the cups.
- Preparation stops automatically. **COFFEE READY** appears on the display.

### One-off setting before and during preparation

The coffee strength can be changed before preparation or during the grinding operation.

The following coffee strengths can be selected for 1 ristretto, 1 espresso, 1 coffee, 1 special coffee, 1 cappuccino and 1 latte macchiato:

- Xmild
- Mild
- Normal
- Strong
- Xstrong



- i** The pre-set **amount of water** can be changed during the brewing operation by turning the Rotary Switch.

One-off settings before and during coffee preparation always follow this model. These settings are not saved.

### Changing the coffee strength before preparation

**Example:** Proceed as follows to prepare a **strong** cup of coffee.

**Precondition:** COFFEE READY is shown on the display.



- ▶ Place a cup under the coffee spout.
-  ▶ Turn the Rotary Switch until **STRONG** appears on the display.
-  ▶ Press the Coffee button **for as long as** **STRONG** is displayed.  
**1 COFFEE / STRONG.**

The pre-set amount of water flows into the cup. Preparation stops automatically. COFFEE READY appears on the display.

### Changing the amount of water during preparation

**Example:** Proceed as follows to prepare a **110 ML** cup of coffee.

**Precondition:** COFFEE READY is shown on the display.

- ▶ Place a cup under the coffee spout.
-  ▶ Press the Coffee button.  
The grinding operation starts. **1 COFFEE** appears on the display, and then the strength is shown.
-  ▶ Turn the Rotary Switch **during** the brewing operation until **110 ML** is displayed.

The set amount of water flows into the cup. Preparation stops automatically. COFFEE READY appears on the display.

### Entering a permanent setting for the amount of water for a cup size

It is easy to make permanent settings for the amount of water for all coffee and milk specialities as well as hot water according to the cup size. As in the following example, adjust the amount of water once. Every time you prepare a drink in the future, this amount of water will be dispensed.

The permanent settings for adapting the amount of water to to the cup size for all coffee and milk specialities as well as hot water follow this model.

**Example:** To enter **permanent** settings for the amount of water for a ristretto, proceed as follows:

**Precondition:** COFFEE READY is shown on the display.

- ▶ Place an espresso cup under the coffee spout.

- ▶ Press and **hold** the Ristretto button.  
1 RISTRETTO and the coffee strength is displayed.
- ▶ **Hold** the Ristretto button down until ENOUGH? / PRESS BUTTON appears.
- ▶ Release the Ristretto button.  
Coffee preparation starts and the ristretto flows into the cup.
- ▶ Press any button as soon as enough ristretto has flowed into the cup.  
Preparation stops automatically. CONFIRMED ✓ appears briefly on the display. The set amount of water for a ristretto is saved as a permanent value. COFFEE READY is shown on the display.

**i** You can alter these settings at any time by repeating the above procedure.

## Permanent settings in programming mode

You can easily adjust your IMPRESSA to your personal coffee blends and specialities. Simply by turning and pressing the Rotary Switch, you can navigate through the easy-to-understand program steps and make permanent settings.

You can make the following settings with the Rotary Switch:

Programme item	Subitem	Explanation
MAINTENANCE	CAPPUCCINO CLEANING, FILTER CHANGE, MACHINE CLEAN, CAPPUCCINO RINSING, MACHINE DESCALE, MACHINE RINSE	▶ Select the desired maintenance programme. If no action is taken, programming mode is exited automatically after approx. five seconds.
PRODUCTS	SELECT PRODUCT	▶ Select your settings for the coffee and milk specialities and hot water.
FILTER I.P.W.S.	YES NO	▶ Indicate whether you operate your IMPRESSA with or without a CLARIS plus filter cartridge.

### 3 Familiarising yourself with the control options

Programme item	Subitem	Explanation
HARDNESS (is only displayed when the filter is not activated)	NOT ACTIVE, 1° dH - 30° dH	▶ Adjust the water hardness.
ENERGY ESM	SAVE NO, SAVE LEVEL1, SAVE LEVEL2	▶ Select an energy saving mode.
TIME	--!--	▶ Set the time and weekday.
UNIT ON	--!-- MTWTFSS	▶ Set the switch-on and switch-off time individually for each weekday.
OFF AFTER	NOT ACTIVE, 0.5 HRS - 15 HRS	▶ Set the number of hours after which the IMPRESSA should switch off automatically.
RINSES	START RINSE, CAPPU. RINSE	▶ Set whether the switch-on rinse should be started manually or automatically. ▶ Set whether the prompt for cappuccino rinsing should be started immediately or 10 minutes after preparation of a milk speciality.
RENAME ABC...	PRODUCT NAME, WELCOME MESSAGE, CLOSING	▶ Change the individual designations.
LOGO		▶ Select a logo which is displayed when the graphic display is not used for other information.
INFORMATION		▶ Keep track of all prepared coffee and milk specialities and view the care status.
DISPLAY	UNIT, TIME FORMAT	▶ Select the unit of the amount of water and the time format.
LANGUAGE	DEUTSCH ENGLISH FRANCAIS ITALIANO NL	▶ Select your language.
EXIT		▶ Exit programming mode.

Settings in programming mode always follow the same model.

**Example:** To change the strength of one espresso from **NORMAL** to **STRONG** proceed as follows:

**Precondition:** **COFFEE READY** is shown on the display.

- ⏻ ▶ Keep the Rotary Switch pressed **until** **MAINTENANCE** appears.
- ⌚ ▶ Turn the Rotary Switch until **PRODUCTS** is displayed.
- ⏻ ▶ Press the Rotary Switch to enter the programme item.  
**PRODUCTS / SELECT PRODUCT**

**i** Next select the product button for which you would like to make settings. No coffee speciality is prepared during this procedure.

**i** To enter a setting for the double product, press the corresponding button twice within a period of two seconds.

- ☑ ▶ Press the Espresso button.  
**1 ESPRESSO / AMOUNT 60 ML**
- ⌚ ▶ Turn the Rotary Switch until **1 ESPRESSO / NORMAL** is displayed.
- ⏻ ▶ Press the Rotary Switch to enter the programme item.  
**1 ESPRESSO / NORMAL**
- ⌚ ▶ Turn the Rotary Switch until **1 ESPRESSO / STRONG** appears.
- ⏻ ▶ Press the Rotary Switch to confirm the setting.  
**CONFIRMED ✓** appears briefly on the display to confirm the setting.  
**1 ESPRESSO / STRONG**
- ⌚ ▶ Turn the Rotary Switch until **1 ESPRESSO / EXIT** is displayed.
- ⏻ ▶ Press the Rotary Switch to exit the programme item.  
**PRODUCTS / SELECT PRODUCT**
- ⌚ ▶ Turn the Rotary Switch until **PRODUCTS / EXIT** is displayed.
- ⏻ ▶ Press the Rotary Switch to exit the programme item.  
**PRODUCTS**

### 3 Familiarising yourself with the control options

- ⌚ ▶ Turn the Rotary Switch until **EXIT** is displayed.
- ⌚ ▶ Press the Rotary Switch to exit programming mode.  
**COFFEE READY**

## View information and care status

Under the programme item **INFORMATION** you can query the following information:

- Number of the prepared coffee and milk specialities and hot water
- Care status and number of executed maintenance programmes (cleaning, descaling, filter change)
- Number of performed cappuccino cleaning operations

**Precondition:** **COFFEE READY** is shown on the display.

- ⌚ ▶ Press the Rotary Switch **until** **MAINTENANCE** appears.
- ⌚ ▶ Turn the Rotary Switch until **INFORMATION** is displayed.
- ⌚ ▶ Press the Rotary Switch to enter the programme item.  
**TOTAL**, the sum of all prepared coffee and milk specialities is displayed.
- ⌚ ▶ Turn the Rotary Switch for further information.

**i** The care status can also be displayed in addition to the number of performed maintenance programmes. The bar shows the current care status. When the bar is filled completely, your IMPRESSA will request the respective maintenance programme.

- ⌚ ▶ Press the Rotary Switch to exit the programme item.  
**INFORMATION**
- ⌚ ▶ Turn the Rotary Switch until **EXIT** is displayed.
- ⌚ ▶ Press the Rotary Switch to exit programming mode.  
**COFFEE READY**





## 4 Recipes

You can use your IMPRESSA to create coffee classics or extraordinary specialities in your home. You can find additional coffee recipes online at [www.jura.com](http://www.jura.com).

Further information on how to operate your IMPRESSA can be found in Chapter 3, 'Familiarising yourself with the control options'.

### Cappuzino

<b>Ingredients</b>	<b>200 ml cold milk</b>
<b>(for two people)</b>	<b>2 strong Espresso</b>
	<b>20 ml cinnamon syrup</b>
	<b>Powdered cinnamon for decoration purposes</b>

- ▶ Distribute the cinnamon syrup into Cappuccino cups.
- ▶ Place cup under the Professional Cappuccino Frother and half fill with milk foam.
- ▶ Pour Espresso directly into the milk foam and sprinkle it with cinnamon powder.

### Café Chocolat Blanc

<b>Ingredients</b>	<b>50 g white chocolate</b>
<b>(for two people)</b>	<b>2 Espresso</b>
	<b>200 ml milk</b>
	<b>Grated white chocolate for decoration purposes</b>

- ▶ Froth milk in two decorative glasses with the Professional Cappuccino Frother.
- ▶ Melt white chocolate in a bain marie.
- ▶ Prepare two Espresso, stir with the melted chocolate and pour into the milk foam.
- ▶ Sprinkle grated white chocolate over the drinks.









## Winter's dream coffee

<b>Ingredients</b> (for two people)	2 strong Espresso
	200 ml of hot cocoa
	1 pinch of gingerbread seasoning
	100 ml milk
	Sugar to suit personal taste
	1-2 gingerbread cakes for decoration

- ▶ Prepare 2 Espresso.
- ▶ Stir Espresso with cocoa and gingerbread seasoning and distribute into two glasses.
- ▶ Froth the milk and add to the Espresso.
- ▶ Sprinkle with small pieces of gingerbread.

## Latte Macchiato Frio

<b>Ingredients</b> (for two people)	2 cold Espresso
	200 ml cold milk
	1 small cup crushed ice
	20 ml maple syrup
	Milk foam

- ▶ Prepare Espresso and allow to cool.
- ▶ Put cold milk, the maple syrup and crushed ice in a glass and mix.
- ▶ Add the cold Espresso.



## 5 Preparation at the touch of a button

In this chapter you will find out how to prepare coffee specialities, milk and hot water without making further settings.

Chapter 3, 'Familiarising yourself with the control options', will teach you how to adjust the settings to your personal preferences. Alternatively, you can use Chapter 6, 'Permanent settings in programming mode'.

- i** You can stop the machine at any time while a coffee or milk product or hot water is being prepared. To do this, press any button.
- i** During preparation, you can change the set amount by turning the Rotary Switch.
- @** You can also try out the preparation of coffee specialities online. Visit the Knowledge Builder at [www.jura.com](http://www.jura.com).

### Barista tips

A 'barista' is someone who is a professional at preparing espresso and coffee. The barista knows every coffee speciality and is a master at preparing perfect beverages. In conjunction with your JURA IMPRESSA, you too can achieve perfect results.

In addition to the simple preparation at the touch of a button, you can also adapt the coffee or espresso to suit your own individual taste. Various setting options are provided to this purpose. Give it a try:

- **Coffee strength:** The coffee strength can be changed before preparation or during the grinding operation by turning the Rotary Switch. This setting changes the coffee powder quantity. The larger the quantity of coffee powder which is used to make the coffee, the stronger and more intensive the coffee speciality will taste.
- **Fineness of grind:** In the IMPRESSA the coffee beans are freshly ground each time a coffee speciality is prepared. The fineness of grind can be adjusted during the grinding operation.



tion. Select a finer grind for espresso than for coffee. The fineness of grind affects the time the water requires to run through the coffee powder. A finer coffee powder prolongs the extraction time so that the maximum aroma is unfolded when espresso is prepared.

- **Temperature:** In programming mode on the IMPRESSA you can adjust the temperature of the coffee specialities. The temperature can affect the taste of the coffee and must be adapted to suit individual tastes and the type of coffee bean.
- **Height-adjustable coffee spout:** The height of the coffee spout can be adjusted on a sliding scale as required to suit the size of your coffee cups. The distance between the coffee spout and the edge of the cup should be as small as possible. This prevents coffee splashing on the machine and produces a fine, thick crema.

In addition remember the following barista tips:

- Store your coffee in a dry place. Oxygen, light, heat and moisture will spoil the coffee.
- Use only fresh, cold water so that the coffee aroma can optimally unfold.
- To enjoy perfect coffee, please change the water every day.
- Pre-heat your cups.
- Use a teaspoon for sugar and do not use sugar lumps to ensure that the crema or milk foam are not spoilt.

## Ristretto

**Example:** This is how to prepare a ristretto.

- ▶ Place an espresso cup under the coffee spout.
- ☞ ▶ Press the Ristretto button.  
1 RISTRETTO and the coffee strength is then briefly displayed.  
 The pre-set amount of water flows into the cup. Preparation stops automatically. COFFEE READY appears on the display.

## Espresso

The classic coffee drink from Italy. There is a definite crema on the surface of the espresso.

**Example:** This is how to prepare an espresso.

- ▶ Place an espresso cup under the coffee spout.
- ☞ ▶ Press the Espresso button.  
1 ESPRESSO and the coffee strength is then briefly displayed.

The pre-set amount of water flows into the cup. Preparation stops automatically. COFFEE READY appears on the display.

## Coffee

**Example:** This is how to prepare a coffee.

- ▶ Place a cup under the coffee spout.
- ☞ ▶ Press the Coffee button.  
1 COFFEE and the coffee strength is then briefly displayed.

The pre-set amount of water flows into the cup. Preparation stops automatically. COFFEE READY appears on the display.

## Special coffee



**Example:** This is how to prepare a special coffee.

- ▶ Place a cup under the cappuccino nozzle.
- ☞ ▶ Press the Special Coffee button.  
1 SPECIAL and the coffee strength is then briefly displayed.

The pre-set amount of water flows into the cup. Preparation stops automatically. COFFEE READY appears on the display.

## Cappuccino

A classic Italian recipe. The finishing touch for the cappuccino is a sprinkling of cocoa powder.

**Example:** This is how to prepare a cappuccino.

**Precondition:** COFFEE READY is shown on the display.

- ▶ Remove the milk pipe from the packaging of the vacuum milk container. For a milk carton/bottle use the long pipe, for the vacuum milk container the short pipe.



- ▶ Attach the milk pipe to the nozzle.
- ▶ Insert the other end in a milk carton/bottle or connect it to the vacuum milk container.
- ▶ Place a cup under the cappuccino nozzle.
- ▶ Turn the selection lever of the nozzle to the milk foam position .
- ▶ Press the Cappuccino button.

**1 CAPPUCCINO** and the coffee strength is displayed.

**1 CAPPUCCINO / MILK**, the milk foam is being prepared.

The operation stops automatically after reaching the pre-set amount of milk.

**1 CAPPUCCINO**

**1 CAPPUCCINO / COFFEE**, coffee preparation starts.

Preparation stops automatically after reaching the pre-set amount of water. **COFFEE READY** is shown on the display.

To ensure that the cappuccino nozzle works perfectly, you should rinse and clean it regularly. The description for this can be found in Chapter 7 'Maintenance – Cappuccino nozzle'.

## Latte macchiato

Your IMPRESSA prepares a latte macchiato at the touch of a button.



**Example:** This is how to prepare a latte macchiato.

**Precondition:** **COFFEE READY** is shown on the display.

- ▶ Remove the milk pipe from the packaging of the vacuum milk container. For a milk carton/bottle use the long pipe, for the vacuum milk container the short pipe.
- ▶ Attach the milk pipe to the nozzle.
- ▶ Insert the other end in a milk carton/bottle or connect it to the vacuum milk container.

## 5 Preparation at the touch of a button



- ▶ Place a glass under the cappuccino nozzle.
  - ▶ Turn the selection lever of the nozzle to the milk foam position .
- i** To enable the typical layers of a Latte Macchiato to form even more effectively, add 10 ml of cool milk to the glass before preparing this speciality.
- i** You can refine your Latte Macchiato even more by also adding a little flavoured syrup to the glass as well.
-  ▶ Press the Latte Macchiato button.
- 1** LATTE MAC. and the coffee strength is displayed.
- 1** LATTE MAC. / MILK, the milk foam is being prepared.
- The operation stops automatically after reaching the pre-set amount of milk.
- 1** LATTE MAC.
- i** A brief interval follows during which the hot milk separates from the milk foam. This enables the formation of the typical layers of a latte macchiato. The duration of this interval can be defined in programming mode.
- 1** LATTE MAC. / COFFEE, coffee preparation starts.
- Preparation stops automatically after reaching the pre-set amount of water. COFFEE READY is shown on the display.

To ensure that the cappuccino nozzle works perfectly, you should rinse and clean it regularly. The description for this can be found in Chapter 7 'Maintenance – Cappuccino nozzle'.

## Pre-ground coffee

You can choose a second coffee blend with the filler funnel for pre-ground coffee.

- i** Never add more than two level measuring spoons of pre-ground coffee.
- i** Use pre-ground coffee which is not ground too finely. Very fine coffee can block up the system so that the coffee only comes out in drips.
- i** If you did not fill the machine with a sufficient amount of pre-ground coffee, **PRE-GROUND / NOT ENOUGH** is displayed and the IMPRESSA stops operation.
- i** The desired coffee speciality must be prepared within approx. one minute after filling with the pre-ground coffee. Otherwise, the IMPRESSA stops the operation and is ready to use again.

All coffee specialities with pre-ground coffee are prepared following this model.



**Example:** This is how to prepare a cup of coffee using pre-ground coffee.

- ▶ Place a cup under the coffee spout.
- ▶ Open the cover of the bean container.
- ▶ Open the cover for pre-ground coffee.  
**PRE-GROUND / FILL POWDER**
- ▶ Place one level measuring spoon of pre-ground coffee into the filler funnel.
- ▶ Close the cover for pre-ground coffee.  
**PRE-GROUND / SELECT PRODUCT**
- ☞ ▶ Press the Coffee button.  
**i COFFEE**, coffee preparation starts.  
The pre-set amount of water flows into the cup. Preparation stops automatically. **COFFEE READY** appears on the display.

## Hot milk



**Precondition:** COFFEE READY is shown on the display.

- ▶ Remove the milk pipe from the packaging of the vacuum milk container. For a milk carton/bottle use the long pipe, for the vacuum milk container the short pipe.
- ▶ Attach the milk pipe to the nozzle.
- ▶ Insert the other end in a milk carton/bottle or connect it to the vacuum milk container.
- ▶ Place a cup under the cappuccino nozzle.
- ▶ Turn the selection lever of the nozzle to the milk position .
- ▶ Press the Milk button. .

**1 MILK**, the hot milk flows into the cup.

The operation stops automatically after reaching the pre-set amount of milk. COFFEE READY is shown on the display.

To ensure that the cappuccino nozzle works perfectly, you should rinse and clean it regularly. The description for this can be found in Chapter 7 'Maintenance – Cappuccino nozzle'.

## Hot water

The following temperatures can be selected for preparing hot water:

- Low
- Normal
- High



---

There is a danger of scalding from hot water splashes.

- ▶ Avoid direct contact with skin.
- 

**Precondition:** COFFEE READY is shown on the display.

- ▶ Place a cup under the hot water spout.
  - ▶ Press the Hot water button. 
- HOT WATER** and the temperature is displayed.

- ▶ By pressing the hot water button several times (**within approx. 2 seconds**) you can set the temperature to your individual preference. This setting is not saved.



## 5 Preparation at the touch of a button

The pre-set amount of water flows into the cup. Preparation stops automatically. **COFFEE READY** appears on the display.

## 6 Permanent settings in Programming mode

### Products

With the **PRODUCTS** programme item you can enter individual settings for all coffee products, milk, hot water and coffee-milk products.

### Settings for coffee products, milk and hot water

The following permanent settings can be entered for coffee products, milk and hot water:

Product	Temp.	Coffee strength	Amount
1 Ristretto	LOW, NORMAL, HIGH	XMILD, MILD, NORMAL, STRONG, XSTRONG	15 ML - 240 ML
2 Ristretti	LOW, NORMAL, HIGH	-	15 ML - 240 ML (per cup)
1 Espresso	LOW, NORMAL, HIGH	XMILD, MILD, NORMAL, STRONG, XSTRONG	15 ML - 240 ML
2 Espresso	LOW, NORMAL, HIGH	-	15 ML - 240 ML (per cup)
1 Coffee	LOW, NORMAL, HIGH	XMILD, MILD, NORMAL, STRONG, XSTRONG	15 ML - 240 ML
2 Coffees	LOW, NORMAL, HIGH	-	15 ML - 240 ML (per cup)
1 Special coffee	LOW, NORMAL, HIGH	XMILD, MILD, NORMAL, STRONG, XSTRONG	15 ML - 240 ML
2 Special coffees	LOW, NORMAL, HIGH	-	15 ML - 240 ML (per cup)
1 Milk	-	-	3 SEC - 120 SEC
2 Milk	-	-	3 SEC - 240 SEC
Hot water	LOW, NORMAL, HIGH	-	15 ML - 450 ML



- i** For 1 milk and 1 special coffee you can also select whether the preparation of 2 milks or 2 special coffees should be **doable** or **not doable**.

### Settings for coffee-milk-products

The following permanent settings can be entered for coffee-milk products:



Product	Temp.	Coffee strength	Amount
1 Cappuccino	LOW, NORMAL, HIGH	XMILD, MILD, NORMAL, STRONG, XSTRONG	Amount of milk: 3 SEC - 120 SEC Pause: 0 SEC - 60 SEC Amount of water: 15 ML - 240 ML
2 Cappuccini	LOW, NORMAL, HIGH	-	Amount of milk: 3 SEC - 240 SEC Pause: 0 SEC - 60 SEC Amount of water: 15 ML - 240 ML (per cup)
1 Latte Macchiato	LOW, NORMAL, HIGH	XMILD, MILD, NORMAL, STRONG, XSTRONG	Amount of milk: 3 SEC - 120 SEC Pause: 0 SEC - 60 SEC Amount of water: 15 ML - 240 ML
2 Latte Macchiati	LOW, NORMAL, HIGH	-	Amount of milk: 3 SEC - 240 SEC Pause: 0 SEC - 60 SEC Amount of water: 15 ML - 240 ML (per cup)

- i** For 1 cappuccino and 1 latte macchiato you can also select whether the preparation of 2 cappuccini or 2 latte macchiati should be **doable** or **not doable**.

Permanent settings in programming mode always follow the same model.









**Example:** Proceed as follows to change the amount of milk of 1 latte macchiato from **16 SECS** to **20 SECS**, the pause from **30 SEC** to **40 SEC** and the amount of water from **45 ML** to **40 ML**.

**Precondition:** **COFFEE READY** is shown on the display.

-  ▶ Keep the Rotary Switch pressed **until** **MAINTENANCE** appears.
-  ▶ Turn the Rotary Switch until **PRODUCTS** is displayed.
-  ▶ Press the Rotary Switch to enter the programme item.  
**PRODUCT / SELECT PRODUCT**

**i** Next select the product button for which you would like to make settings. No product is prepared during this procedure.

**i** To change a setting for a double product, press the corresponding button twice within a period of two seconds.

-  ▶ Press the Latte Macchiato button.  
**1 LATTE MAC. / AMOUNT 45 ML**
-  ▶ Press the Rotary Switch to enter the programme item.  
**1 LATTE MAC. / AMOUNT 45 ML**
-  ▶ Turn the Rotary Switch until **1 LATTE MAC. / AMOUNT 40 ML** is displayed.
-  ▶ Press the Rotary Switch to confirm the setting.  
**CONFIRMED ✓** appears briefly on the display to confirm the setting.  
**1 LATTE MAC. / AMOUNT 40 ML**
-  ▶ Turn the Rotary Switch until **1 LATTE MAC. / MILK 16 SECS** is displayed.
-  ▶ Press the Rotary Switch to enter the programme item.  
**1 LATTE MAC. / MILK 16 SECS**
-  ▶ Turn the Rotary Switch until **1 LATTE MAC. / MILK 20 SECS** is displayed.
-  ▶ Press the Rotary Switch to confirm the setting.  
**CONFIRMED ✓** appears briefly on the display.  
**1 LATTE MAC. / MILK 20 SECS**

- ⌚ ▶ Turn the Rotary Switch until 1 LATTE MAC. / PAUSE 30 SEC is displayed.
- ⌚ ▶ Press the Rotary Switch to enter the programme item.  
1 LATTE MAC. / PAUSE 30 SEC
- ⌚ ▶ Turn the Rotary Switch until 1 LATTE MAC. / PAUSE 40 SEC is displayed.
- ⌚ ▶ Press the Rotary Switch to confirm the setting.  
CONFIRMED ✓ appears briefly on the display.  
1 LATTE MAC. / PAUSE 40 SEC
- ⌚ ▶ Turn the Rotary Switch until 1 LATTE MAC. / EXIT is displayed.
- ⌚ ▶ Press the Rotary Switch to exit the programme item.  
PRODUCT / SELECT PRODUCT
- ⌚ ▶ Turn the Rotary Switch until PRODUCT / EXIT is displayed.
- ⌚ ▶ Press the Rotary Switch to exit the programme item.
- ⌚ ▶ Turn the Rotary Switch until EXIT is displayed.
- ⌚ ▶ Press the Rotary Switch to exit programming mode.  
COFFEE READY







## Energy-save mode

You can also set various energy saving modes on your IMPRESSA:

- ENERGY SAVE NO
  - Your IMPRESSA is continuously ready for use.
  - All coffee and milk products, as well as hot water, can be prepared without having to wait.
- ENERGY SAVE LEVEL1
  - Your IMPRESSA is only continuously ready for use for coffee products.
  - The machine has to heat up for milk preparation.
- ENERGY SAVE LEVEL2
  - Approx. 5 minutes after the last preparation the IMPRESSA switches to the energy-saving temperature and is not ready for use.
  - Before coffee, hot water or milk can be prepared, the machine has to heat up.

**Example:** Proceed as follows to change the energy saving mode from `ENERGY SAVE NO` to `ENERGY LEVEL1`.

**Precondition:** `COFFEE READY` is shown on the display.







-  ▶ Keep the Rotary Switch pressed **until** `MAINTENANCE` is displayed.
-  ▶ Turn the Rotary Switch until `ENERGY ESM` is displayed.
-  ▶ Press the Rotary Switch to enter the programme item.  
`ENERGY SAVE NO`
-  ▶ Turn the Rotary Switch until `ENERGY SAVE LEVEL1` is displayed.
-  ▶ Press the Rotary Switch to confirm the setting.  
`CONFIRMED ✓` appears briefly on the display to confirm the setting.  
`ENERGY ESM`
-  ▶ Turn the Rotary Switch until `EXIT` is displayed.
-  ▶ Press the Rotary Switch to exit programming mode.  
`COFFEE READY`

## Time and weekday

You already set the time and weekday when you used the machine for the first time.

**Example:** To change the time from `08:45` to `09:50`, proceed as follows.

**Precondition:** `COFFEE READY` is shown on the display.

-  ▶ Keep the Rotary Switch pressed **until** `MAINTENANCE` appears.
-  ▶ Turn the Rotary Switch until `TIME 08:45` is displayed.
-  ▶ Press the Rotary Switch to enter the programme item.  
`TIME HOURS 08:45.`
-  ▶ Turn the Rotary Switch until `TIME HOURS 09:45` is displayed.
-  ▶ Press the Rotary Switch to confirm the hour setting.
-  ▶ Turn the Rotary Switch until `TIME MINUTES 09:50` is displayed.
-  ▶ Press the Rotary Switch to confirm the minute setting.  
`CONFIRMED ✓` appears briefly on the display to confirm the setting.  
`WEEKDAY MONDAY` (Example)

- ⌚ ▶ Press the Rotary Switch to confirm the weekday setting.  
CONFIRMED ✓ appears briefly on the display.  
TIME 09:150
- ⌚ ▶ Turn the Rotary Switch until EXIT is displayed.
- ⌚ ▶ Press the Rotary Switch to exit programming mode.  
COFFEE READY

## Programmable Switch-on time

The programmable switch-on time can only be set when the time has been set.

The following settings can be made in the UNIT ON menu item:

- UNIT ON
  - Set the required switch-on time.
- MACHINE OFF
  - Set the required switch-off time.
- DAY
  - Set the weekdays on which IMPRESSA should switch on and off automatically.

- i** The programmable switch-on only works when the machine is switched on at the power switch (standby).

**Example:** Proceed as follows to set the programmable switch-on time to 07:30 and stipulate that your IMPRESSA does not switch on automatically on Sundays.

**Precondition:** COFFEE READY is shown on the display.

- ⌚ ▶ Keep the Rotary Switch pressed until MAINTENANCE appears.
- ⌚ ▶ Turn the Rotary Switch until UNIT ON / ---!---MTWTFSS is displayed.
- ⌚ ▶ Press the Rotary Switch to enter the programme item.  
UNIT ON ---!---
- ⌚ ▶ Press the Rotary Switch to enter the programme item.  
UNIT ON/HOURS ---!---
- ⌚ ▶ Turn the Rotary Switch until UNIT ON/HOURS 07:00 is displayed.
- ⌚ ▶ Press the Rotary Switch to confirm the hour setting.

## 6 Permanent settings in programming mode

- ⌚ ▶ Turn the Rotary Switch until **UNIT ON / MINUTES**  
**07:30** is displayed.
- ⌚ ▶ Press the Rotary Switch to confirm the minute setting.  
**CONFIRMED ✓** appears briefly on the display to confirm the setting.  
**UNIT ON 07:30**
- ⌚ ▶ Turn the Rotary Switch until **DAY** is displayed.
- ⌚ ▶ Press the Rotary Switch to enter the programme item.  
**DAY / MON YES**
- ⌚ ▶ Turn the Rotary Switch until **TAG / SUN YES** is displayed.
- ⌚ ▶ Press the Rotary Switch to enter the programme item.  
**DAY / SUN YES**
- ⌚ ▶ Turn the Rotary Switch until **TAG / SUN NO** is displayed.
- ⌚ ▶ Press the Rotary Switch to confirm the setting.  
**CONFIRMED ✓** appears briefly on the display.  
**DAY / SUN NO**
- ⌚ ▶ Turn the Rotary Switch until **EXIT** is displayed.
- ⌚ ▶ Press the Rotary Switch to exit the programme item.  
**DAY**
- ⌚ ▶ Turn the Rotary Switch until **EXIT** is displayed.
- ⌚ ▶ Press the Rotary Switch to exit the programme item.  
**UNIT ON / 07:30 MTWTFSS**
- ⌚ ▶ Turn the Rotary Switch until **EXIT** is displayed.
- ⌚ ▶ Press the Rotary Switch to exit programming mode.  
**COFFEE READY**

## Automatic switch-off

By instructing your IMPRESSA to automatically switch itself off, you can cut down your energy consumption. If this function is activated, your IMPRESSA switches off automatically after the last action on the machine.

- i** The automatic switch-off time can be adjusted between 0.5 and 15 hours or deactivated.

**Example:** Proceed as follows to change the automatic switch-off time from **5 HRS** to **2 HRS**.

**Precondition:** **COFFEE READY** is shown on the display.

- ⌚ ▶ Keep the Rotary Switch pressed **until** **MAINTENANCE** appears.
- ⌚ ▶ Turn the Rotary Switch until **OFF AFTER 5 HRS** is displayed.
- ⌚ ▶ Press the Rotary Switch to enter the programme item.  
**OFF AFTER 5 HRS**
- ⌚ ▶ Turn the Rotary Switch until **OFF AFTER 2 HRS** is displayed.
- ⌚ ▶ Press the Rotary Switch to confirm the setting.  
**CONFIRMED ✓** appears briefly on the display to confirm the setting.  
**OFF AFTER 2 HRS**
- ⌚ ▶ Turn the Rotary Switch until **EXIT** is displayed.
- ⌚ ▶ Press the Rotary Switch to exit programming mode.  
**COFFEE READY**

## Rinses

You can set whether the switch-on rinse should be started manually or automatically.

You can set whether cappuccino rinsing should be prompted immediately or 10 minutes after a milk product has been prepared.

**Example:** Proceed as follows to programme that cappuccino rinsing should be prompted **immediately** after a milk product has been prepared.

**Precondition:** **COFFEE READY** is shown on the display.

- ⌚ ▶ Keep the Rotary Switch pressed **until** **MAINTENANCE** appears.
- ⌚ ▶ Turn the Rotary Switch until **RINSES** is displayed.
- ⌚ ▶ Press the Rotary Switch to enter the programme item.  
**START RINSE MANUAL**
- ⌚ ▶ Turn the Rotary Switch until **CAPPU. RINSE AFTER 10 MIN** is displayed.
- ⌚ ▶ Press the Rotary Switch to enter the programme item.  
**CAPPU. RINSE AFTER 10 MIN**

## 6 Permanent settings in programming mode

- ⦿ ▶ Turn the Rotary Switch until **CAFFU. RINSE NOW** is displayed.
- ⦿ ▶ Press the Rotary Switch to confirm the setting.  
**CONFIRMED ✓** appears briefly on the display to confirm the setting.  
**CAFFU. RINSE NOW**
- ⦿ ▶ Turn the Rotary Switch until **RINSES EXIT** is displayed.
- ⦿ ▶ Press the Rotary Switch.  
**RINSES**
- ⦿ ▶ Turn the Rotary Switch until **EXIT** is displayed.
- ⦿ ▶ Press the Rotary Switch to exit programming mode.  
**COFFEE READY**

## Unit amount of water/ time format

You can change the unit of the amount of water from 'ml' to 'oz' and the time format to '24 HRS' or 'AM/PM'.

**Example:** To change the unit for the amount of water from **UNIT ML** to **UNIT OZ**, proceed as follows.

**Precondition:** **COFFEE READY** is shown on the display.

- ⦿ ▶ Keep the Rotary Switch pressed **until MAINTENANCE** appears.
- ⦿ ▶ Turn the Rotary Switch until **SETTINGS** is displayed.
- ⦿ ▶ Press the Rotary Switch to enter the programme item.  
**SETTINGS UNIT**

**i** To change the time format, turn the Rotary Switch until **SETTINGS TIME FORMAT** is displayed.

- ⦿ ▶ Press the Rotary Switch to enter the programme item.  
**SETTINGS UNIT ML**
- ⦿ ▶ Turn the Rotary Switch until **SETTINGS UNIT OZ** is displayed.
- ⦿ ▶ Press the Rotary Switch to confirm the setting.  
**CONFIRMED ✓** appears briefly on the display to confirm the setting.  
**SETTINGS UNIT**



- ⦿ ▶ Turn the Rotary Switch until **SETTINGS EXIT** is displayed.
- ⏻ ▶ Press the Rotary Switch to exit the programme item.  
**DISPLAY**
- ⦿ ▶ Turn the Rotary Switch until **EXIT** is displayed.
- ⏻ ▶ Press the Rotary Switch to exit programming mode.  
**COFFEE READY**

## Logo

You can choose various logos which appear when the display is not used for other information. The following logos can, for example, be selected:

- JURA Logo
- Animated coffee cup
- Time
- No logo

**Example:** Proceed as follows to show the time on the display.

**Precondition:** **COFFEE READY** is shown on the display.

- ⏻ ▶ Keep the Rotary Switch pressed **until** **MAINTENANCE** appears.
- ⦿ ▶ Turn the Rotary Switch until **LOGO** is displayed.
- ⏻ ▶ Press the Rotary Switch to enter the programme item.  
**LOGO**
- ⦿ ▶ Turn the Rotary Switch until **LOGO 08:45** (example) is displayed.
- ⏻ ▶ Press the Rotary Switch to confirm the setting.  
**CONFIRMED ✓** appears briefly on the display to confirm the setting.  
**LOGO 08:45** (example)
- ⦿ ▶ Turn the Rotary Switch until **EXIT** is displayed.
- ⏻ ▶ Press the Rotary Switch to exit programming mode.  
**COFFEE READY / 08:45**

## Language







You set the language when you used the machine for the first time.

You can choose among the following languages.

- German
- English
- French
- Italian
- Dutch

**Example:** To change the language from **ENGLISH** to **DEUTSCH**, proceed as follows.

**Precondition:** **COFFEE READY** is shown on the display.

-  ▶ Keep the Rotary Switch pressed **until** **MAINTENANCE** is displayed.
-  ▶ Turn the Rotary Switch until **LANGUAGE ENGLISH** is displayed.
-  ▶ Press the Rotary Switch to enter the programme item.  
**LANGUAGE ENGLISH**
-  ▶ Turn the Rotary Switch until **SPRACHE DEUTSCH** appears.
-  ▶ Press the Rotary Switch to confirm the setting.  
**GESPEICHERT ✓** appears briefly on the display to confirm the setting.  
**SPRACHE DEUTSCH**
-  ▶ Turn the Rotary Switch until **EXIT** is displayed.
-  ▶ Press the Rotary Switch to exit programming mode.  
**BITTE WAHLEN**

## Rename

All product names as well as the on message and closing can be changed.

**Example:** To change the product name from **1 COFFEE** to **MY COFFEE**, proceed as follows:

**Precondition:** **COFFEE READY** is shown on the display.

-  ▶ Keep the Rotary Switch pressed **until** **MAINTENANCE** appears.

⌚ ▶ Turn the Rotary Switch until **RENAME ABC...** is displayed.

⌚ ▶ Press the Rotary Switch to enter the programme item.  
**RENAME PRODUCT NAME**

**i** The welcome text and closing can be selected by turning the Rotary Switch.

⌚ ▶ Press the Rotary Switch to enter the programme item.  
**PRODUCT NAME CHANGE**

⌚ ▶ Press the Rotary Switch.  
**PRODUCT NAME / SELECT PRODUCT**

**i** Next select the button of the product which you would like to rename. No product is prepared during this procedure.

☒ ▶ Press the Coffee button.  
**\_ / ABCDEFG...✓**

⌚ ▶ Turn the Rotary Switch so that it points to the correct character.

⌚ ▶ Press the Rotary Switch to confirm the character.  
**MY COFFEE / ABCDEFG...✓**

**i** To delete the character which was entered last, select the character **+** at the end of the alphabet and press the Rotary Switch.

⌚ ▶ Select the character **✓** at the end of the alphabet and press the Rotary Switch to confirm the entry.  
**CONFIRMED ✓** appears briefly on the display.  
**RENAME ABC...**

⌚ ▶ Turn the Rotary Switch until **EXIT** appears on the display.

⌚ ▶ Press the Rotary Switch to exit programming mode.  
**COFFEE READY**

## 7 Maintenance

Your IMPRESSA has the following integrated maintenance programmes:

- Rinse machine
- Filter change
- Clean machine
- Descale machine
- Rinse cappuccino nozzle
- Clean cappuccino nozzle

**i** Clean or descale the machine or change the filter whenever the appropriate indicator lights up.

### Maintenance tips

To ensure that you get many years' reliable service out of your IMPRESSA and to guarantee the optimum coffee quality, the machine requires daily maintenance.

You should proceed as follows:

- Empty the coffee grounds container and the drip tray. Rinse them with warm water.
- Rinse the water tank with clean water.
- Dismantle and rinse the cappuccino nozzle (see Chapter 7, 'Maintenance – Rinsing the cappuccino nozzle')
- Wipe the surface of the machine with a damp cloth.

### Rinse machine

When the IMPRESSA is switched on, a prompt to perform a rinse operation appears after heating, or this is automatically started.

It can be set in programming mode whether the switch-on rinse needs to be activated manually or whether the machine automatically activates the switch-on rinse (see Chapter 6 'Permanent settings in programming mode – Rinses').

When the IMPRESSA is switched off, a rinse operation is automatically initiated.

You can initiate the rinse operation manually at any time.



**Precondition:** COFFEE READY is shown on the display.

- ▶ Place a receptacle under the coffee spout.
  - ⌚ ▶ Keep the Rotary Switch pressed **until** MAINTENANCE appears.
  - ⌚ ▶ Press the Rotary Switch to enter the programme item. CAPPUCCINO CLEANING
  - ⌚ ▶ Turn the Rotary Switch until MACHINE RINSING appears.
  - ⌚ ▶ Press the Rotary Switch to initiate the rinse operation. RINSING
- Rinsing stops automatically and your IMPRESSA is then ready for use.

## Changing the filter

- i** After 50 litres of water have flowed through the filter, or after two months, its capacity is reached. Your IMPRESSA will automatically prompt you to change the filter.
- i** If the CLARIS plus filter cartridge is not activated, you will not be prompted to change the filter.

@ You can also try out ‘changing the filter’ online. Visit the Knowledge Builder at [www.jura.com](http://www.jura.com).

## Change following a prompt

To change the CLARIS plus filter cartridge when prompted to do so by your IMPRESSA, proceed as follows:

**Precondition:** COFFEE READY / FILTER CHANGE is displayed and the maintenance button ☼ lights up.

- ☼ ▶ Press the maintenance button. CHANGETIME 2 MIN / START YES

- i** If you want to change the filter at a later point in time, turn the Rotary Switch until CHANGE / START NO is displayed. Exit the maintenance programme by pressing the Rotary Switch. The prompt ‘change filter’ remains on the display.

- ⚠ ▶ Press the maintenance button.  
**INSERT FILTER / PRESS BUTTON**
- ▶ Remove the water tank and empty it.
- ▶ Open up the cartridge holder and remove the old CLARIS plus filter cartridge and the extension piece.
- ▶ Fit the extension on top of a new CLARIS plus filter cartridge.
- ▶ Insert the filter cartridge into the water tank, exerting slight pressure.
- ▶ Close the cartridge holder. It will click into place audibly.
- ▶ Fill the water tank with fresh, cold water and reinsert.



- ▶ Place a receptacle (containing at least 500 ml) under the cappuccino nozzle.
- ▶ Turn the selection lever of the nozzle to the steam position ☞.
- ⚠ ▶ Press the maintenance button.  
**FILTER RINSE**, water flows from the nozzle.

- i** You can interrupt filter rinsing at any time. To do this, press any button.
- i** The water may be slightly discoloured. This is not harmful to health and does not affect the taste.

Filter rinsing stops automatically after approx. 500 ml. Your IMPRESSA heats up and is once again ready to use.

### Manual filter change

You can initiate the 'Changing the filter' operation manually.

**Precondition:** The filter is activated and **COFFEE READY** appears on the display.

- ⌚ ▶ Keep the Rotary Switch pressed **until** **MAINTENANCE** appears.
- ⌚ ▶ Press the Rotary Switch to enter the programme item.  
**CAPPUCCINO CLEANING**

- ⊙ ▶ Turn the Rotary Switch until **FILTER CHANGE** is displayed.
- ⊙ ▶ Press the Rotary Switch.  
**CHANGE TIME 2 MIN / START YES**
- ▶ Continue with the **second** prompt to take action (indicated by a ▶), as is described under **'Replacement following a prompt'**.

## Clean machine

After 220 coffee preparations or 80 switch-on rinses, the IMPRESSA will prompt you to clean it.

### CAUTION

If the wrong cleaning agent is used, the machine could be damaged and/or traces of detergent could be left behind in the water.

- ▶ Use only original JURA care products.

- i** The cleaning programme only lasts about 20 minutes.
- i** Do not interrupt the cleaning programme. The quality of cleaning will be impaired if you do so.
- i** JURA cleaning tablets are available from stockists.

- @ You can also try out the 'clean machine' operation online. Visit the Knowledge Builder at [www.jura.com](http://www.jura.com).

## Cleaning following a prompt

**Precondition:** **COFFEE READY / CLEAN** is displayed and the maintenance button  lights up.

-  ▶ Press the maintenance button.

**CLEANING TIME 20 MIN / START YES**

- i** If you want to clean the machine at a later point in time, turn the Rotary Switch until **CLEANING / START NO** is displayed. Exit the maintenance programme by pressing the Rotary Switch. The prompt 'clean machine' remains on the display.

-  ▶ Press the maintenance button.

**TRAY / GROUNDS EMPTY**

- ▶ Empty the drip tray and coffee grounds container and put them back into the machine.

## 7 Maintenance

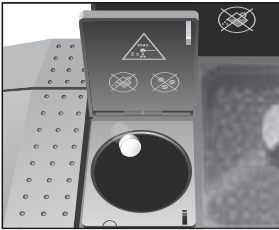

**PRESS BUTTON**, the maintenance button  lights up.

- ▶ Place a receptacle under the coffee spout and the cappuccino nozzle.
-  ▶ Press the maintenance button.

**MACHINE IS CLEANING**, water flows out of the coffee spout.

The process is interrupted, **ADD TABLET**.

- ▶ Open the cover of the bean container.
- ▶ Open the cover of the filler funnel for pre-ground coffee.
- ▶ Insert a JURA cleaning tablet into the filler funnel.
- ▶ Close the cover of the filler funnel and the cover of the bean container.

**PRESS BUTTON**, the maintenance button  lights up.

-  ▶ Press the maintenance button.

**MACHINE IS CLEANING**, water flows out of the coffee spout and the cappuccino nozzle several times.

The process is interrupted **TRAY / GROUNDS EMPTY**.





- ▶ Empty the drip tray and coffee grounds container and put them back into the machine.

The cleaning operation is now complete. The IMPRESSA is once more ready for use.

## Manual cleaning

You can initiate the 'Cleaning the machine' operation manually.

**Precondition:** **COFFEE READY** is shown on the display.

-  ▶ Keep the Rotary Switch pressed **until MAINTENANCE** appears.
-  ▶ Press the Rotary Switch to enter the programme item. **CAPPUCCINO CLEANING**
-  ▶ Turn the Rotary Switch until **MACHINE CLEAN** is displayed.
-  ▶ Press the Rotary Switch. **CLEANING TIME 20 MIN / START YES**
  - ▶ Continue with the **second** prompt to take action (indicated by a ▶), as is described under '**Cleaning following a prompt**'.



## Descal machine



The IMPRESSA builds up deposits of limescale over time and automatically prompts you to descale it when necessary. The degree of calcification depends on the degree of hardness of your water.

---

If the descaling agent comes into contact with the skin or eyes, this can cause irritation.

- ▶ Avoid contact with the skin or eyes.
- ▶ Rinse the descaling agent off with clean water. Should you get any descaling agent in your eye, consult a doctor.

**CAUTION**

---

If the wrong descaling agent is used, the machine could be damaged and/or traces of detergent could be left behind in the water.

- ▶ Use only original JURA care products.

**CAUTION**

---

If the descaling operation is interrupted, there may be damage to the machine.

- ▶ Allow the descaling programme to run to the end.

**CAUTION**

---

If the descaling agent comes into contact with sensitive surfaces, damage may occur.

- ▶ Clean up any splashes immediately.

- 
- i** The descaling programme lasts approx. 45 minutes.
  - i** JURA descaling tablets are available from stockists.
  - i** If you use a CLARIS plus filter cartridge and this is activated, you will not be prompted to change the filter.

@ You can also try out the 'Descaling the machine' operation online. Visit the Knowledge Builder at [www.jura.com](http://www.jura.com).

## Descaling following a prompt

**Precondition:** COFFEE READY / DESCALE is displayed and the maintenance button ☼ lights up.

- ☼ ▶ Press the maintenance button.

DECALCIFYING TIME 45 MIN / START YES

**i** If you want to descale the machine at a later point in time, turn the Rotary Switch until **DECALCIFYING / START NO** is displayed. Exit the maintenance programme by pressing the Rotary Switch. The prompt 'Descal machine' remains on the display.

❖ ▶ Press the maintenance button.

**TRAY / GROUNDS EMPTY**

▶ Empty the drip tray and coffee grounds container and put them back into the machine.

**SOLVENT IN TANK**

▶ Remove the water tank and empty it.

▶ Completely dissolve the contents of one blister (3 JURA descaling tablets) in a container that holds 600 ml of water. This may take several minutes.

▶ Pour the solution into the empty water tank and insert it in the machine.

**SOLVENT IN TANK / PRESS BUTTON**, the maintenance button ❖ lights up.

▶ Remove the cappuccino nozzle.

▶ Place a receptacle under the hot water spout and the connector of the nozzle.

❖ ▶ Press the maintenance button.

**MACHINE IS DECALCIFYING**

Water flows from the hot water spout and the connector of the nozzle. The maintenance button ❖ blinks during the descaling operation.

The process stops automatically, **TRAY / GROUNDS EMPTY**.

▶ Empty the receptacles below the hot water spout and the connector of the nozzle.

▶ Empty the drip tray and coffee grounds container and put them back into the machine.

**WATER TANK FILL**

▶ Remove the water tank and rinse it thoroughly.

▶ Fill the water tank with fresh, cold mains water and reinsert.

**PRESS BUTTON**, the maintenance button ❖ lights up.

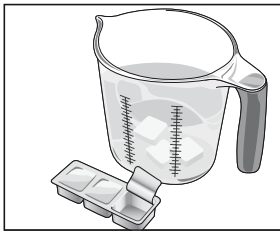

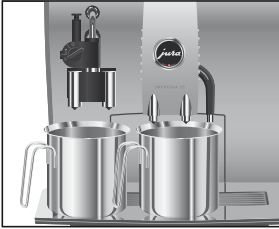

- ▶ Replace the cappuccino nozzle.
- ▶ Place a receptacle under the hot water and coffee spout and the cappuccino nozzle.
- ⚠ ▶ Press the maintenance button.
  - MACHINE IS DECALCIFYING, water flows out of the hot water spout and the cappuccino nozzle.
  - UNIT IS HEATING, RINSING water flows out of the coffee spout.
  - The process stops automatically, TRAY / GROUNDS EMPTY.
- ▶ Empty the drip tray and coffee grounds container and put them back into the machine.
  - The descaling operation is now complete. Your IMPRESSA heats up and is once again ready to use.

**i** If the descaling operation stops unexpectedly, rinse the water tank thoroughly.

## Manual descaling

You can initiate the operation 'Descaling the machine' manually.

**Precondition:** COFFEE READY appears on the display and the filter is not activated.

- ⌚ ▶ Keep the Rotary Switch pressed until MAINTENANCE appears.
- ⌚ ▶ Press the Rotary Switch to enter the programme item.
  - CAPPUCCINO CLEANING
- ⌚ ▶ Turn the Rotary Switch until DESCALE MACHINE is displayed.
- ⌚ ▶ Press the Rotary Switch.
  - DECALCIFYING TIME 45 MIN / START YES
  - ▶ Continue with the **second** prompt to take action (indicated by a ▶), as is described under '**Descaling following a prompt**'.

## Rinsing the cappuccino nozzle

Each time milk has been prepared the IMPRESSA displays a prompt for cappuccino rinsing.

It can be set in programming mode whether the rinsing prompt is displayed **immediately** or **10 minutes** after preparation (refer to Chapter 6 'Permanent settings in programming mode – Rinses').

### Rinsing the cappuccino nozzle after prompt



**Precondition:** `COFFEE READY / CAPPU. RINSING` is shown on the display, the maintenance button  lights up.

- ▶ Place a receptacle under the cappuccino nozzle.
- ▶ Turn the selection lever of the nozzle to the steam position .

 ▶ Press the maintenance button.

`CAPPUCCINO RINSING`, the cappuccino nozzle is rinsed.

Preparation stops automatically. `COFFEE READY` appears on the display.

## Cleaning the cappuccino nozzle

To ensure that the cappuccino nozzle works perfectly, you should clean it **daily** when you have been preparing milk.

### CAUTION

---

If the wrong cleaning agent is used, the machine could be damaged and/or traces of detergent could be left behind in the water.

- ▶ Use only original JURA care products.
- 

**i** The IMPRESSA will not prompt you to clean the cappuccino nozzle.

**i** The JURA Auto-Cappuccino Cleaner is available from stockists.



@ You can also try out the 'Cleaning the cappuccino nozzle' operation online. Visit the Knowledge Builder at [www.jura.com](http://www.jura.com).

## Starting cappuccino cleaning manually



## Cleaning the cappuccino nozzle after prompt

**Precondition:** **COFFEE READY** is shown on the display.

- ▶ Keep the Rotary Switch pressed **until MAINTENANCE** appears.
- ▶ Press the Rotary Switch to enter the programme item. **CAPPUCCINO CLEANING**
- ▶ Press the Rotary Switch. **CLEANER FOR CAPPUCCINO / PRESS BUTTON**
  - ▶ Pour 250 ml of fresh water into a container and add one capful (max. 15 ml) of Auto-Cappuccino Cleaner.
  - ▶ Immerse the milk pipe in the receptacle.
  - ▶ Turn the selection lever to the milk foam position  or milk .
  - ▶ Place another receptacle under the cappuccino nozzle.
- ▶ Press the maintenance button. **CAPPUCCINO CLEANING**, the nozzle and pipe are cleaned. **WATER FOR CAPPUCCINO / PRESS BUTTON**
  - ▶ Rinse the receptacle thoroughly, fill it with approx. 250 ml of fresh water and immerse the milk pipe in the water.
  - ▶ Empty the receptacle and place it under the nozzle once more.
- ▶ Press the maintenance button. **CAPPUCCINO CLEANING**, the nozzle and pipe are rinsed with fresh water. **COFFEE READY** appears on the display. Your IMPRESSA is once more ready to use.

If milk has been prepared, but the cappuccino nozzle has not been cleaned, the **CLEAN MILK SYSTEM** prompt is displayed when the machine is switched off. The maintenance programme can be started by pressing the maintenance button .

**Precondition:** **CLEANER FOR CAPPUCCINO / PRESS BUTTON** appears on the screen and the maintenance button  lights up.

- ▶ Continue with the **fourth** prompt to take action (indicated by a ▶), as is described under ‘**Start cappuccino cleaning manually**’.

## Dismantling and rinsing the cappuccino nozzle

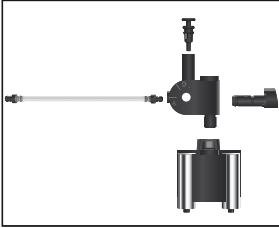

- ▶ Carefully pull off the cappuccino nozzle.
- ▶ Dismantle the cappuccino nozzle completely.
- ▶ Rinse all the nozzle parts thoroughly under running water.
- ▶ Reassemble the cappuccino nozzle and attach it once more to the connector.

## Removing foreign objects

Even the highest-quality coffee beans can contain foreign objects. These can block the grinder.

- ▶ Switch your machine off with the On/Off button.
- ▶ Switch your machine off at the power switch.
- ▶ Open the cover of the bean container and remove the aroma preservation cover.
- ▶ Remove the beans with a vacuum cleaner.
- ▶ Position the grinder key.
- ▶ Turn the key **counterclockwise** until the jammed foreign object is released, and remove the object.
- ▶ Fill the bean container with coffee beans, then close the aroma preservation cover and the bean container cover.



## Cleaning the bean container

Coffee beans may be covered with a slight oil film which remains on the walls of the bean container. These residues may negatively affect the coffee results. For this reason clean the bean container from time to time.

**Precondition:** COFFEE READY / FILL BEANS is shown on the display.

- ▶ Switch your machine off with the On/Off button.
- ▶ Switch your machine off at the power switch.
- ▶ Open the cover of the bean container and remove the aroma preservation cover.

- ▶ Clean the bean container with a soft, dry cloth.
- ▶ Fill the bean container with coffee beans, then close the aroma preservation cover and the bean container cover.  
The cleaning of the bean container is now complete.

## Descaling the water tank

Limescale deposits may form in the water tank. To ensure correct function of the machine, descale the water tank from time to time.

- ▶ Remove the water tank.
- ▶ If you use a CLARIS plus filter cartridge, remove this.
- ▶ Descale the tank with a mild, commercially available descaling agent in accordance with the instructions of the manufacturer.
- ▶ Rinse the water tank with clean water afterwards.
- ▶ If you use a CLARIS plus filter cartridge, insert this again.
- ▶ Fill the water tank with fresh, cold water and reinsert.





## 8 CLARIS plus filter cartridge – Water for perfect coffee

### As fresh as from the spring

Anyone who has ever drunk fresh spring water knows: There is a world of difference between the elixir of life in its natural form and the processed fluid that comes out of our taps. Very few of us have ready access to a spring.

The answer to this is: CLARIS plus filter cartridge from JURA. It transforms the hardness of the mains water into pH-neutral water. On top of this, CLARIS plus can protect your fully automated coffee/Espresso machine against scale, and used properly, can prolong the service life of your machine.

Our mains water is of very high quality and is excellent for drinking. It is subject to ongoing health checks, meets strict, legally binding quality requirements and contains the most important minerals and fluorides.

### Water – always pleasant and freshly filtered

Use of CLARIS plus filter cartridges guarantees you freshly filtered, delicious-tasting water for your tea and coffee at all times. Designed specially for JURA coffee machines, it has neutral pH and is placed directly in the water tank.

This gives you three important benefits:

- The guarantee that your water is freshly filtered before any cup of coffee is prepared;
- Fresh water and unadulterated aromas guarantee your palate the coffee experience of a lifetime;
- Lifelong protection for your IMPRESSA (eliminating the need for descaling).

CLARIS plus from JURA is hard on scale, but soft on your coffee machine.

## **Quality knows no compromises**

You can see it at work on your household appliances every day. Left to its own devices, scale can cause serious damage. Over time, scale is deposited on the heating elements, clogging the heating elements and pipes. Scale is also detrimental to the quality of your chosen drinks because, with the passage of time, the water will no longer be properly heated. Consequently: The result is that the coffee will taste weaker, Espresso will lose its strength and tea will taste bland. In other words: All enjoyment will be lost.

## **Quality from A to Z**

When you buy coffee, Espresso or tea specialities, aren't you careful to buy top quality? In that case, you should insist on the same for your water. You will taste and smell the difference the moment you start using the CLARIS plus filter cartridge. The water will taste purer and you will be thrilled by the flavour of your coffee specialities.

## **No more descaling**

If you use CLARIS plus filter cartridges regularly, you will be able to omit the time-consuming business of regular descaling. And your coffee machine will reward you with a longer service life. We recommend use of CLARIS plus wherever water is harder than 10° German hardness (dH). You can determine the water hardness before using your JURA coffee machine for the first time with the Aquadur® test strip included in the Welcome Pack.

## **Interaction of organic materials**

The CLARIS plus filter cartridge was developed specially for JURA fully automatic coffee/Espresso machines. It contains a granulate consisting of ion exchangers and active carbon – in other words, pure, organic materials with no chemical additives. These agents work together to reduce the formation of calcium deposits, heavy metals and other harmful substances contained in mains water. Other substances detrimental to flavour and aroma, such as chlorine, are also largely eliminated. Minerals and fluorides contained in the water are, of course, retained.

## **Water freshly filtered on the 'just in time' principle**

Unlike other water filtering systems for domestic use, CLARIS plus works according to the professional up-flow principle. Practically speaking: Only the precise amount of water required for a given beverage is drawn in, and this is filtered directly before use.

**Up-flow principle**

The water flows through the filter at a constant speed, disturbing the granulate and ensuring that it is used evenly. This system ensures that the filter is used to optimum effect. The remaining water in the tank is left untouched until the next cup of coffee is made.

**Easy to operate**

Inserting the CLARIS plus filter cartridge couldn't be easier. It is described in Chapter 2, 'Preparing and using for the first time – Using and activating filter'.

**Economical in use**

After 50 litres of water have been dispensed or after two months at the latest, the filter will cease to work. After this, the cartridge must be replaced. Your JURA coffee machine will prompt you to change the filter.

This process is described in detail in Chapter 7, 'Maintenance – changing the filter'.

You can return used filter cartridges to the stockist. They are returned for recycling to protect the environment.

**Maintenance and storage**

The CLARIS plus filter cartridge only needs to be removed from the water tank if you are away for a lengthy period of time or if you wish to clean or descale the tank using a conventional product.

If you do plan to be away for some time (e.g. for a holiday), we recommend that you do the following to store the filter cartridge. Remove the cartridge from the water tank. Place it in a glass with about two centimetres of water and put it in the fridge.

We recommend that you run about half a litre of water through the machine before starting to make coffee again. The water could be discoloured, but this is not harmful to your health.

**Pictures on the next few pages:**

- 1 Water – always pleasant and freshly filtered.
- 2 CLARIS plus filter cartridges do not require any accessories and do not take up any extra space. They can be inserted directly into the water tank.
- 3 4 Water for perfect coffee specialities.
- 5 The professional up-flow principle: Only the precise amount of water required for a given beverage is drawn in, and this is filtered directly before use.
- 6 Stainless steel pipes in the heater element: With CLARIS plus (left) you can omit the time-consuming descaling operation (right).
- 7 The following substances are filtered out through the interaction with organic materials: calcium (Ca), chlorine (Cl), lead (Pb), copper (Cu), aluminium (Al).











5



6

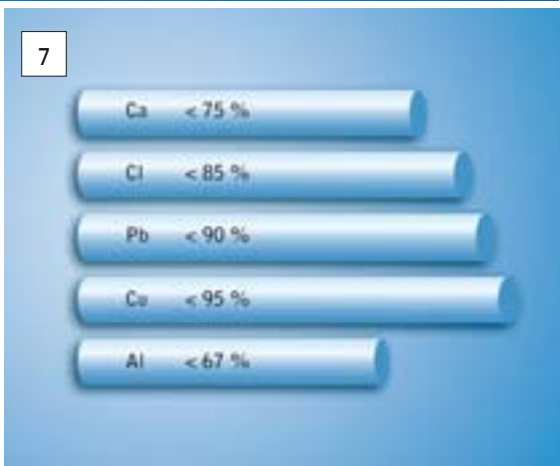

7



## 9 'The milk makes the difference'

Coffee specialities are taking the entire planet by storm. Up until a few years ago, classics, such as Espresso and Café Crème were the most popular choices. Today, Cappuccino, Latte Macchiato & co. have well surpassed them.

### **Trendy specialities with milk**

More and more often, one finds milk among the ingredients of the trendy specialities. It doesn't matter whether whole milk or skim milk is used. It isn't the fat content which is crucial for the wonderful foam, but the protein. Heated or frothed, as cream or whipped cream, no other natural product is combined with coffee as often or with as much pleasure as milk. There is a wide variety of alternatives available to allergy sufferers as well: goat/sheep milk, rice milk or soy milk.

### **Most modern technology**

The most modern technology and ingenious Cappuccino nozzles allow you to delve into the multi-faceted world of coffee specialities with every IMPRESSA. Here, the milk is not heated to above 75 °C. This is namely the only way that the inimitable fine foam can be fully developed.

Thanks to the variable brewing unit, which can prepare between 5 and 16 grams of coffee powder under ideal conditions, you can make sure that the tastes of the coffee and milk are harmoniously balanced. Simply allow your imagination to run free in creating new recipes and add flavour and fineness to your personal favourite coffee specialities according to your mood.

### **Frothing as done by a professional**

Make sure you try out the secret Barista tip: Because milk can form a vortex on the rough surface of a stainless steel pot especially well, perfect foam can be formed in these receptacles. And the professional also knows what must also be given special attention: Regularly and thoroughly clean the Cappuccino nozzle, rinse out the milk container well every evening and store the milk in the refrigerator overnight.

## 10 Accessories and Service

### Extend your coffee horizon

1 Coffee specialities made with milk are very fashionable these days. The One Touch cappuccino nozzle: The quickest, most direct and simple way to delve into the world of coffee and to revel in all its variety.

### Care products

2 Original JURA care products are optimally tailored to the maintenance programmes. You should therefore use only original JURA care products. Your IMPRESSA will thank you for it.

### CLARIS plus filter cartridge

3 The CLARIS plus filter cartridge was developed specially for JURA coffee machines. It is placed directly into the water tank. CLARIS plus works according to the professional up-flow principle.

Further information on this subject can be found in Chapter 8, 'CLARIS plus filter cartridge – Water for perfect coffee'.

### Cleaning tablets

4 Your IMPRESSA machine comes with an integrated cleaning programme. The original JURA cleaning tablets are specifically tailored for the machine and optimally dissolve accumulated coffee oils.

### Descaling tablets

5 Scale is the biggest enemy of all household appliances that involve the use of mains water. JURA has developed a descaling tablet for the IMPRESSA which removes scale and at the same time is easy on your machine.

### Auto-Cappuccino Cleaner

6 Clean your Professional Cappuccino Frother and Easy-Cappuccino Frother with the original Auto-Cappuccino Cleaner from JURA. This will ensure that it is 100% clean.

### Service

7 Competent, high-quality service is a top priority as far as JURA is concerned, irrespective of whether it is provided by the glassy service factory of the Swiss parent company or in the authorised JURA service centres all around the world.

8 Every IMPRESSA service is preceded by an electronically controlled diagnostic run.

9 Service work is performed competently and professionally by JURA's trained technicians.











4



5

6











SERVICE FABRIK



8



9

## 11 Display messages

Message	Cause/Result	Action
TRAY EMPTY	The drip tray is full. You cannot prepare any coffee products, hot water or milk products.	▶ Empty the drip tray.
WATER TANK FILL	The water tank is empty. You cannot prepare any coffee products, hot water or milk products.	▶ Fill the water tank (See Chapter 2, 'Preparing and using for the first time – Filling the water tank').
GROUNDS EMPTY	The coffee grounds container is full. You cannot prepare any coffee products, but you can prepare hot water or milk.	▶ Empty the coffee grounds container and the drip tray.
TRAY MISSING	The drip tray is not inserted correctly or is not inserted at all. You cannot prepare any coffee products, hot water or milk products.	▶ Insert the drip tray. ▶ Clean the metal contacts on the back of the drip tray.
COFFEE TRAY MISSING	The coffee grounds container is not inserted correctly or is not inserted at all. You cannot prepare any coffee products, hot water or milk products.	▶ Insert the coffee grounds container.
PRESS RINSE	The IMPRESSA is prompting you to rinse it.	▶ Press the maintenance button to start rinsing.
COFFEE READY / FILL BEANS	The bean container is empty. You cannot prepare any coffee products, but you can prepare hot water or milk.	▶ Fill the bean container (See Chapter 2, 'Preparing and using for the first time – Filling the bean container').
COFFEE READY / CAPPU. RINSE	The IMPRESSA is prompting you to run cappuccino rinsing.	▶ Press the maintenance button to start cappuccino rinsing.

11 Messages on plain text display

Message	Cause/Result	Action
COFFEE READY / CLEAN	After 220 preparations or 80 switch-on rinses, the IMPRESSA will prompt you to clean it.	▶ Clean the machine (See Chapter 7, 'Maintenance – Cleaning the machine').
COFFEE READY / CLEAN (flashes)	After 250 preparations the IMPRESSA will prompt you to clean it.	▶ Clean the machine (See Chapter 7, 'Maintenance – Cleaning the machine').
CLEAN NOW / CLEAN (flashes)	After 260 preparations the IMPRESSA will prompt you to clean it.	▶ Clean the machine (See Chapter 7, 'Maintenance – Cleaning the machine').
COFFEE READY / DESCALE	The IMPRESSA is prompting you to descale it.	▶ Descale the machine (See Chapter 7, 'Maintenance – Descaling the machine').
COFFEE READY / DESCALE (flashes)	The IMPRESSA is prompting you to descale it.	▶ Descale the machine (See Chapter 7, 'Maintenance – Descaling the machine').
DECALCIFY NOW / DESCALE (flashes)	The IMPRESSA is prompting you to descale it.	▶ Descale the machine (See Chapter 7, 'Maintenance – Descaling the machine').
COFFEE READY / FILTER CHANGE	After 2 months or when 50 litres of water have flowed through the filter, its capacity is reached.	▶ Replace the CLARIS plus filter cartridge (refer to Chapter 7 'Maintenance – Changing the filter').
COFFEE READY / FILTER CHANGE (flashes)	After 2 months or when 55 litres of water have flowed through the filter, its capacity is reached.	▶ Replace the CLARIS plus filter cartridge (refer to Chapter 7 'Maintenance – Changing the filter').
CHANGE NOW / FILTER CHANGE (flashes)	After 2 months or when 60 litres of water have flowed through the filter, its capacity is reached.	▶ Replace the CLARIS plus filter cartridge (See Chapter 7 'Maintenance – Changing the filter').

Message	Cause/Result	Action
CLEANER FOR CAPPUCCINO / PRESS BUTTON	The IMPRESSA prompts you to clean the cappuccino nozzle.	▶ Perform cappuccino cleaning (refer to Chapter 7 'Maintenance – Cleaning the cappuccino nozzle').
BEANCOVER MISSING	The beancover is not inserted correctly or is not inserted at all. You cannot prepare any coffee products, but you can prepare hot water or milk.	▶ Insert the beancover.
PRE-GROUND / NOT ENOUGH	There is too little pre-ground coffee in the filler funnel. The IMPRESSA stops the operation.	▶ The next time you make coffee use more pre-ground coffee (refer to Chapter 5, 'Preparation – Pre-ground coffee').
POWDERFUNNEL	The powder funnel for pre-ground coffee is not fitted.	▶ Insert the powder funnel.
TOO HOT	System is too hot to begin a maintenance programme.	▶ Prepare a coffee speciality or hot water.

## 12 Troubleshooting

Problem	Cause/Result	Action
Grinder is making a very loud noise.	There are foreign objects in the grinder.	▶ Remove the foreign objects (see Chapter 7, 'Maintenance – Removing foreign objects').
The frother does not produce enough milk foam or milk sprays from the cappuccino nozzle.	The cappuccino nozzle is dirty.	▶ Rinse and clean the cappuccino nozzle (see Chapter 7, 'Maintenance – Cappuccino nozzle').
Coffee only comes out in drips when it is being prepared.	Coffee or pre-ground coffee has been ground too finely and is blocking the system.	▶ Put the grinder on a coarser setting or use coarser pre-ground coffee (refer to Chapter 2, 'Preparing and using for the first time – Adjusting grinder').
Water hardness cannot be adjusted.	The CLARIS plus filter-cartridge is activated.	▶ Deactivate the CLARIS plus filter cartridge.
COFFEE READY / FILL BEANS is displayed, although the bean container has been filled.	The grinder is not yet completely filled with beans.	▶ Prepare a coffee speciality.
COFFEE READY / FILL BEANS is not displayed although the bean container is empty.	The bean monitor is dirty.	▶ Clean the bean container (see Chapter 7, 'Maintenance – Cleaning the bean container').
TRAY EMPTY stays on constantly.	The metal contacts of the drip tray are dirty or wet.	▶ Clean the metal contacts on the back of the drip tray.
WATER TANK FILL is displayed although the water tank is full.	The water tank float is trapped.	▶ Descale the water tank (see Chapter 7, 'Maintenance – Descaling the water tank').

Problem	Cause/Result	Action
ERROR 2 is displayed.	If the device was exposed to the cold for a long period of time, it is disabled from heating up due to safety reasons.	▶ Warm up the device at room temperature.
Other ERROR messages are displayed.	–	▶ Turn the IMPRESSA off at the power switch. Contact Customer Support in your country (see Chapter 16 'JURA contact details').

- i** If you have not been able to solve the problem, contact Customer Support in your country. You will find the phone number in Chapter 16, 'JURA contact details'.

## 13 Transport and environmentally neutral disposal

### Transport / Empty system

Keep the packaging of your IMPRESSA. It should be used to protect the machine during transportation.

In order to protect the IMPRESSA from frost during transportation, the system must be emptied.

**Precondition:** The IMPRESSA must be switched off (standby).

- ▶ Remove the water tank.
- ▶ Place a receptacle under the hot water spout and below the cappuccino nozzle.
- ⚠ ▶ Press the maintenance button **until** **SYS. EMPTY.** is displayed.  
A small amount of water flows from the cappuccino nozzle and the hot water spout. The operation stops automatically. The IMPRESSA will switch itself off.
- ▶ Turn your IMPRESSA off at the power switch.



- i** The next time you use the machine the system must be refilled (see Chapter 2, 'Preparing and using your the machine or the first time –First-time use').

### Disposal

Please dispose of old machines in an environmentally neutral way.



Old machines contain valuable materials which should be salvaged for recycling. Please therefore dispose of old machines via your regional collection system.



## 14 Technical data

### Rating plate

- i** The voltage and current vary according to the safety test. Please refer to the rating plate before connecting the device.

The rating plate is located on the bottom of your IMPRESSA. The information shown on the rating plate has the following meaning:

- V AC = alternating current in volts
- W = power output in watts

**CE** This product complies with all applicable EU directives.





**(S)** This product meets the requirements of the Decree concerning Low Voltage Electrical Products and the Decree concerning Electromagnetic Compatibility (VEMV). This is issued by the ESTI (Swiss Federal Inspectorate for Heavy Current Installations).

**(UL)** This product complies with all applicable UL directives (Underwriters Laboratories Inc.®).

**(SAA)** This product complies with all applicable SAA directives (Standards Association of Australia).

**(CCC)** This product complies with all applicable CCC directives (China Compulsory Certification).

**Technical data**

Voltage		230 V AC, 50 Hz
		120 V AC, 60 Hz
		220 –240 V AC, 50 Hz
		220 V AC, 50 Hz
Power	1350 W	
Safety test		
Energy Save No	23 Wh	
Energy Save Level 1	16 Wh	
Energy Save Level 2	14 Wh	
Pump pressure	Static max. 15 bar	
Holding capacity of water tank	2.8 l	
Holding capacity of bean container	280 g	
Holding capacity of coffee grounds container	Approx. 20 servings	
Cable length	Approx. 1.1 m	
Weight	13.3 kg	
Dimensions (W x H x D)	31 x 37 x 43.5 cm	



## 15 Key technologies and products

**1** Intelligent Pre Brew Aroma System (I.P.B.A.S.®).  
Perfect coffee is no accident. The Intelligent Pre Brew Aroma System® produces the very best in flavour from every coffee blend and roast.

**1a** The freshly ground coffee beans are delivered to the infusing cylinder as a powder from the grinder.

**1b** There it is optimally compressed.

**1c** Prior to brewing, the powder is moistened. The pores swell and the flavours are released.

**1d** During brewing, perfect coffee is delivered to the cup, crowned by a velvety, soft crema for perfect enjoyment.

**2** The IMPRESSA range of products includes the following series:

- IMPRESSA Z series, Cappuccino at the touch of a button, premium professional technology for domestic use.
- IMPRESSA S series for demanding households
- IMPRESSA J series, Perfect Enjoyment, Perfect Aesthetics
- IMPRESSA F series, simple operation, multi-winner
- IMPRESSA C series, Click & Drink
- IMPRESSA X series for catering and office applications

Obtain the advice of the JURA experts.

@ You will find the purchase advisor at [www.jura.com](http://www.jura.com).

**3** For perfect coffee quality it is important to get the grinding right. To this end, a powerful 6-level powerful conical burr grinder with grinding cones constructed out of hardened steel is provided.

**4** The variable brewing unit holds between 5 and 16 g of coffee. This means that two cups can be prepared at once in a single brewing operation.

**5** Durable pipes constructed from a high-quality steel alloy conduct the water through the thermoblocks where it is heated to the correct temperature.



**I.P.B.A.S.**®

INTELLIGENT PRE BREW AROMA SYSTEM

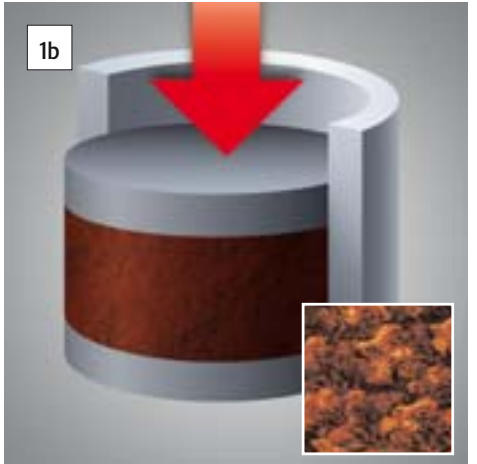



IMPRESSA Z



IMPRESSA S



IMPRESSA J



IMPRESSA F



IMPRESSA C



IMPRESSA X



IMPRESSA XF

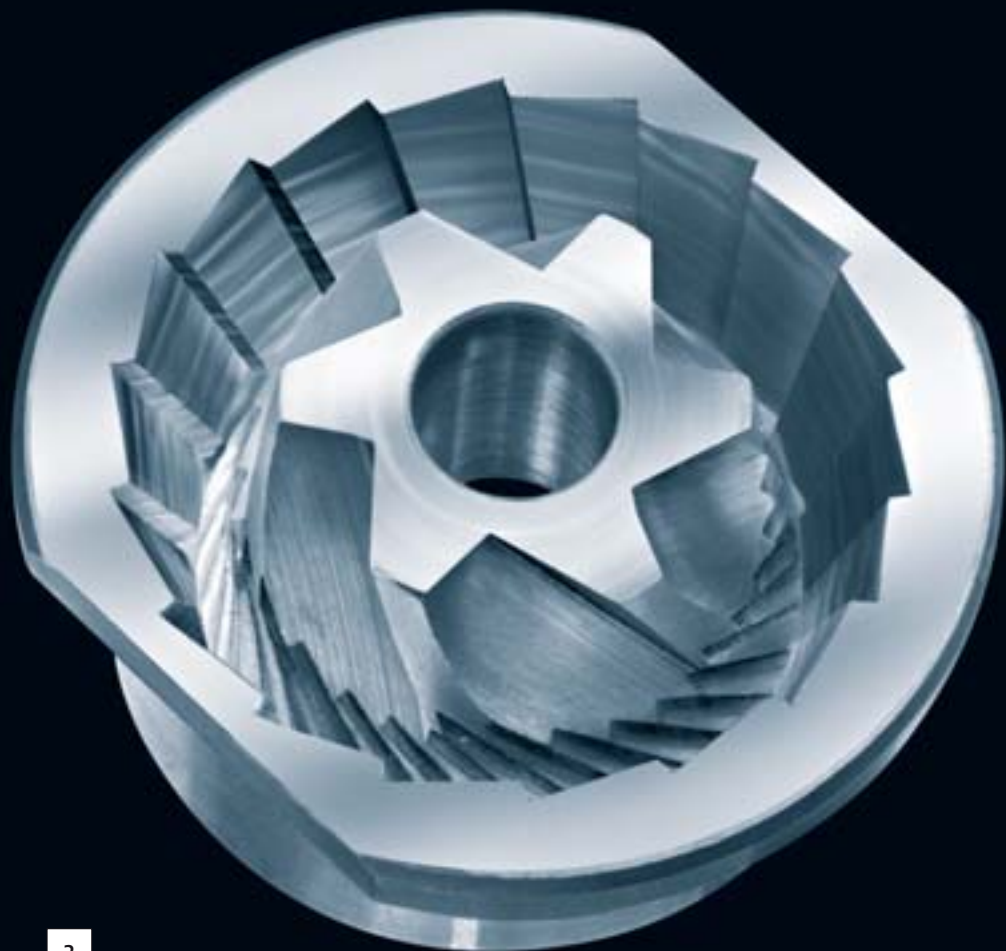

3

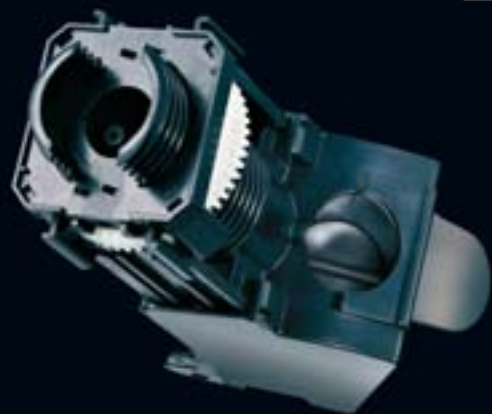

4

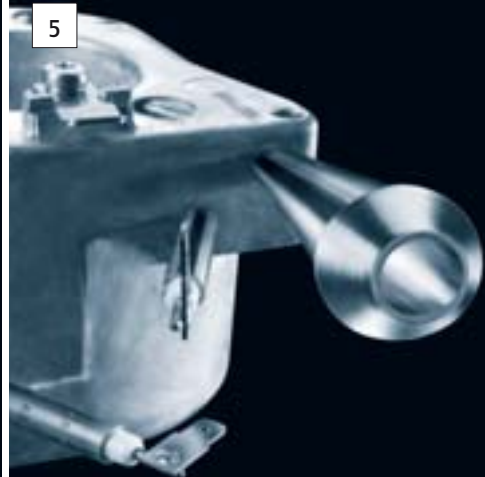

5



## 16 JURA contact details

### A

#### Australia

Global Coffee Solutions Pty Ltd.

Customer Service Phone +61 1300 552 883  
Fax +61 0242 846 099  
E-mail info@globalcoffee.com.au

Opening Hours Monday to Friday  
8:00 am – 5:00 pm

Distributor Address/ Service Address Global Coffee Solutions Pty Ltd  
5/77 Jardine Street  
Fairy Meadow NSW 2519

### B

#### Bangladesh

Please contact the Singapore office for details.

#### Brunei

Please contact the East Malaysian office for details.

#### Burma

Please contact the Singapore office for details.

### C

#### Cambodia

Please contact the Singapore office for details.

#### Canada

Faema Canada

Customer Service Phone (416) 535-1555  
Toll free (877) 323-6226  
Fax (416) 535-3843  
E-mail espresso@faema.net

Opening Hours Monday to Friday  
9:00 am – 6:00 pm  
Saturday 10:00 am – 5:00 pm

Distributor Address/ Service Address Faema Canada  
672 Dupont Street, Suite 201  
Toronto, Ontario M6G 1Z6

### China

Shanghai HJ Coffee Co., Ltd.

Customer Service Phone +86 21 62940690 ext.31  
E-mail service@hjcoffee.com

Opening Hours Monday to Friday 09:00 – 17:30

Distributor Address/ Service Address Shanghai HJ Coffee Co., Ltd.  
Room D 3F, building one  
Xinhua Road No. 543  
Shanghai 200052

### Czech Republic

Petraco, Spol. S R.O.

Customer Service Phone +420 775 997 557  
E-mail dokladal@juraswiss.cz

Opening Hours Monday to Thursday 9:00 – 17:00  
Friday 9:00 – 15:00

Distributor Address/ Service Address Petraco, Spol. S R.O.  
Udolni 5  
602 00 Brno

### D

#### Denmark

Scandinavian CoffeeSystem Aps

Customer Service Phone +45 7020 7333  
Fax +45 7020 7343  
E-mail service@coffeesystem.com

Opening Hours Monday to Thursday 09:00 – 16:30  
Friday 09:00 – 16:00

Distributor Address/ Service Address Scandinavian CoffeeSystem Aps  
Tordenskjoldsgade 19  
1055 Kobenhavn K

**E****Estonia**

Infomelton OÜ

Customer Service Phone +372 651 88 55  
+372 651 88 50  
E-mail lavazza@lavazza.ee

Opening Hours Monday to Friday 09:00 – 17:00

Distributor Address/ Infomelton OÜ  
Service Address Weizenbergi 27  
Tallinn 10150

**F****Finland**

Home Appliance Brokers HAB Oy

Customer Service Phone +358 207 300 090  
E-mail info@haboy.fi

Opening Hours Monday to Friday 08:00 – 16:00

Distributor Address Home Appliance Brokers HAB Oy  
Elimäenkatu 29, 00510 Helsinki

Service Address Monilaite-Thomeko Oy  
Salpakuja 6, 01200 Vantaa

**G****Greece**

COFFEE CONNECTION S.A.

Customer Service Phone +30 210 66 40 640  
E-mail coffeeway@coffeeway.com

Opening Hours Monday to Friday 09:00 – 17:00

Distributor Address/ COFFEE CONNECTION S.A.  
Service Address Agiou Louka str. Peania  
Attica 190 02

**H****Hong Kong PRC**

Pacific Coffee Company Ltd

Customer Service Phone +852 2805 1627  
E-mail sales@pacificcoffee.com

Opening Hours Monday to Friday  
9:00 am – 6:00 pm  
Saturday 9:00 am – 1:00 pm

Distributor Address/ Pacific Coffee Company Ltd  
Service Address 701-704 Hollywood Center  
233 Hollywood Road, Sheung Wan

**I****Iceland**

Karl K. Karlsson

Customer Service Phone +354 540 9003  
E-mail karlk@karlsson.is

Opening Hours Monday to Friday 09:00 – 18:00

Distributor Address/ Karl K. Karlsson  
Service Address Pacific Coffee Company Ltd  
Skútuvogur 5, 104 Reykjavík

**Indonesia Bali**

BHINEKA JAYA

Customer Service Phone +62 361 724746  
Mobile Nr. +62 81 23817951 or  
+62 361 7460521  
E-mail vivi@kopibali.com

Opening Hours Monday to Saturday 08:30 – 16:30

Distributor Address/ BHINEKA JAYA  
Service Address Jl. Pulau Moyo 9A, Denpasar, Bali

**Indonesia Jakarta**

SUKSES PRATAMA JAYA P.T.

Customer Service Phone +62 21 6331177  
Fax +62 21 63857008  
E-mail cs@suprajaya.com

Opening Hours Monday to Saturday 09:00 – 17:00  
Service Number during off hours: +62  
21 6331177

Distributor Address/ SUKSES PRATAMA JAYA P.T.  
Service Address Jalan: K.H. Hasyim Ashari 125  
Pusat Niaga Roxy Mas  
Blok C.4 No.14-15, Jakarta 10150

**Israel**

J.Feffer I.t.d.

Customer Service Phone +972 353 350 38  
 Fax +972 353 305 54  
 E-mail feffer-j@barak-online.net

Opening Hours Sunday–Thursday 08:00 – 18:00  
 Friday 09:00 – 13:00

Distributor Address/ J.Feffer I.t.d.  
 Service Address 9,Simtat Ma'ale Hachoma  
 Ind. Zone  
 Or-Yehuda 60370, Israel

**K****Korea**

HLI Company Limited

Customer Service Phone +82 234 522 127  
 Fax Phone +82 345 229 50  
 E-mail wj\_lee@hlikorea.com

Opening Hours Monday to Friday 09:00 – 18:00

Distributor Address/ HLI Company Limited  
 Service Address 7floor, Sungwon Bldg  
 Yeoksam-Dong, Kangnam-Ku  
 Seoul

**L****Labuan**

Please contact the East Malaysian office for details.

**Latvia**

CREMA SIA

Customer Service Phone +371 7244082  
 +371 26622888  
 E-mail crema@crema.lv

Opening Hours Monday to Friday 10:00 – 17:00

Distributor Address/ CREMA SIA  
 Service Address Gertrudes 86, Riga, LV-1009

**Lithuania**

JSC Pretendentas

Customer Service Phone + 370 315 73442  
 Mobile +370 650 84779  
 E-mail alma@pretendentas.lt

Opening Hours Monday to Friday 09:00 – 18:00

Distributor Address/ JSC Pretendentas  
 Service Address 62161 Alytus, str. Ulonu 33

**M****Malaysia, East**

RICMAS Borneo Sdn. Bhd.

Customer Service Phone +60 88 456 100, –200  
 Fax +60 88 241 600  
 E-mail jura@ricmas-malaysia.com

Opening Hours Monday to Friday 09:00 – 17:30  
 Service Number during off hours: +60  
 16 830 60 83

Distributor Address/ RICMAS Borneo Sdn. Bhd.  
 Service Address Unit # E3–8, 3rd Floor  
 Block E, Plaza Tanjung Aru  
 Jalan Mat Salleh, Tanjung Aru  
 88150 Kota Kinabalu, Sabah

**Malaysia, West**

RICMAS Peninsular Sdn. Bhd.

Customer Service Phone +6 03 4296 5989  
 Fax +6 03 4297 5636  
 E-mail jura@ricmas-malaysia.com

Opening Hours Monday to Friday 09:00 – 17:30  
 Service Number during off hours:  
 016 201 5789

Office Address/ Service RICMAS Peninsular Sdn. Bhd.  
 Address 3A-1 Jalan Perubatan 3  
 Pandan Indah  
 55100 Kuala Lumpur

## N

### New Zealand

Euro Espresso Ltd.

Customer Service Phone +64 9 277 1334  
 Fax +64 9 277 9375  
 E-mail info@euroespresso.co.nz

Opening Hours Monday to Friday  
 8:30 am – 5:00 pm

Distributor Address/ Service Address 6 Mepal Place, Manukau City,  
 Auckland  
 PO Box 76–342, Manukau City,  
 Auckland 1730

### Norway

Black Cat Kaffe og Tehus AS

Customer Service Phone +47 22 06 29 90  
 Fax +47 22 06 29 99  
 E-mail  
 info@blackcatkaffeogtehus.no

Opening Hours Monday to Friday 08:30 – 16:30

Distributor Address/ Service Address Black Cat Kaffe og Tehus AS  
 Aslakveien 20h, 0753 Oslo

## P

### Philippines

Pacific Continental Company Inc.

Customer Service Phone +63 2 551 3216  
 Fax +63 2 831 8314  
 E-mail jura@conlinscoffee.com

Opening Hours Monday to Friday 09:00 – 18:00  
 Service Number during off hours: +63  
 916 5294052

Distributor Address/ Service Address Pacific Continental Company Inc.  
 2753 Park Avenue, Pasay City  
 Metro Manila 1300

### Puerto Rico

ProExpo CA Consultores S.A.

Customer Service Phone +506 234 7404  
 Fax +506 253 5296  
 E-mail info@grupocapresso.com

Distributor Address/ Service Address ProExpo CA Consultores S.A.  
 P.O. Box 75-2120  
 Calle Blancos, San Jose

## S

### Saudi Arabia

Saudi Marketing Solutions

Customer Service Phone +9661 201 2053  
 Fax +9661 201 2056  
 E-mail info@sms-arabia.com

Opening Hours Saturday to Wednesday  
 09:00 – 13:00 and 17:00 – 21:00

Distributor Address P.O.Box 12679 Jeddah 21483

Service Address Aruba & Muhandis Musad  
 Al-Anqari Street Intersection, Riyadh

### Singapore

RICMAS INTERNATIONAL Pte. Ltd.

Customer Service Phone +65 6562 8853  
 Fax +65 6562 8854  
 E-mail jura@ricmas.com

Opening Hours Monday to Friday 09:00 – 17:30  
 Service Number during off hours: +65  
 90210314

Office Address/ Service Address RICMAS INTERNATIONAL Pte. Ltd.  
 25 International Business Park  
 German Center #01–57/58  
 Singapore 609916

---

## South Africa

International Coffee Equipment CC

Customer Service	Phone +27 11 708 2481 E-mail info@icesa.za.net
Opening Hours	Monday to Friday 08.00 – 17.00 Saturday 08.00 – 13.00
Office Address	International Coffee Equipment CC JURA Corner Building, Showroom 475/3 Hans Strydom Drive KYA Sand
Service Address	International Coffee Equipment CC JURA Corner Building, 1st Floor 475/3 Hans Strydom Drive KYA Sand

---

## T

### Taiwan

Eurocafé Corporation

Customer Service	Phone +886 2 28272683 Fax +886 2 28225797 E-mail service@eurocafe.com.tw
Opening Hours	Monday to Friday 9:00 am – 6.00 pm
Office Address/ Service Address	Eurocafé Corporation 2F, No. 251 Sec. 2 Hsi An Street Pei-Tou District Taipei

---

### Thailand

RICMAS (Thailand) Co., Ltd.

Customer Service	Phone +66 2262 0543 Fax +66 2262 0542 E-mail jura@ricmas-thailand.com
Opening Hours	Monday to Friday 09.00 – 17.00 Service Number during off hours: +66 1828 6996
Office Address/ Service Address	55 Biohouse Building Sukhumvit 39 Rd. Klongtan-nue, Wattana, Bangkok 10110

---

## Turkey

John's Coffee

Customer Service	Phone +90 216 420 2400 Fax +90 216 313 56 32 E-mail info@johnscoffee.com.tr
Opening Hours	Monday to Friday 08:30 – 18:00
Office Address/ Service Address	John's Coffee Imes Sanayi Sitesi C blok 308 Sok. Yukari Dudullu-Istanbul, 34776

---

## U

### United Arab Emirates

Boncafé Middle East LLC.

Customer Service	Phone +97 14 28 28 742 Fax +44 20 77 222 333 E-mail info@boncafeme.com
Opening Hours	Saturday to Thursday 8.30 – 17.30 Service Number during off hours: +44 870 165 0429
Distributor Address/ Service Address	Boncafé Middle East LLC. P.O. Box 74044, DUBAI

---

### United Kingdom

Fairfax Coffee Ltd

Customer Service	Phone +44 20 7722 7646 Fax +44 20 77 222 333 E-mail info@fairfaxcookshop.com
Opening Hours	Monday to Friday 09.00 – 17.30
Distributor Address/ Service Address	Fairfax Coffee Ltd 1 Regency Parade, Finchley Road, London NW3 5EQ

---

## V

### Vietnam

Please contact the Singapore office for details.

---

## Index

### A

- Accessories 82
- Adjusting grinder 23
- Assessing and setting water hardness 22
- Automatic switch-off 54

### B

- Bean container 8
  - Cleaning 70
  - Filling 19

### C

- Cappuccino 42
- Cappuccino nozzle
  - Cleaning 68
  - Dismantling and rinsing 70
  - One Touch Cappuccino nozzle 8
  - One Touch cappuccino nozzle 16
  - Rinsing 68
- Care products 82
- CLARIS plus 73, 81
- CLARIS plus filter cartridge
  - Using and activating 21
- Clean
  - Machine 63
- Cleaning
  - Bean container 70
  - Cappuccino nozzle 68
- Coffee 42
- Coffee grounds container 8
- Coffee spout, height adjustable 8
- Cover
  - Bean container 8
  - Water tank 8

### D

- Descale
  - Machine 65
- Descaling
  - Water tank 71
- Display messages 91
- Drip tray 8

### E

- Energy-save mode 51
- Espresso 42

### F

- Filter
  - Change 61
  - Using and activating 21
- Fineness of grind
  - Adjusting grinder 23
- First-time use 19
  - First-time use 19

### G

- Grinding wheel 8
- Ground coffee 45

### H

- Hot milk 46
- Hot water 46
- Hot water spout 8

### I

- Internet 17

### K

- Knowledge Builder 17

### L

- Language 58
- Latte macchiato 43
- Logo 57

### M

- Machine
  - Clean 63
  - Descale 65
  - Rinse 60
- Machine accessories 82
- Maintenance 60
  - Maintenance button 9
  - Maintenance tips 60
  - Viewing maintenance status 32
- Messages on display 91
- Milk 81
  - Hot 46
- Milk container
  - Vacuum milk container 16

**O**

One Touch Cappuccino nozzle 8, 16

**P**

Pre-ground coffee 45

Preparation

At the touch of a button 40

Cappuccino 42

Coffee 42

Espresso 42

Hot milk 46

Hot water 46

Latte macchiato 43

Pre-ground coffee 45

Ristretto 41

Special coffee 42

Problems

Troubleshooting 94

Programmable switch-on time 53

Programming mode 48

Automatic switch-off 54

Energy-save mode 51

Programmable switch-on mode 53

Rename 58

Rinses 55

Switch-on time 53

Time and weekday 52

**R**

Rating plate 97

Recipes 34

Removing foreign objects 70

Removing stones 70

Rename product name 58

Rinse

Cappuccino nozzle 68

Machine 60

Rinses 55

Ristretto 41

Rotary Switch 9, 16

**S**

Safety 10

Service 82

Settings

Default settings in programming mode 48

Entering a default setting for the amount of water for a cup size 28

One-off settings before and during preparation 27

Water hardness 22

Setting up 18

Special coffee 42

Specialities 34

Trendy specialities with milk 81

Standby

Switching off 25

Supplied as standard 18

Switch-off

Automatic 54

Switch-on

Switch-on time 53

Switch-on time, programmable 53

Switching off 25

Standby 25

Switching on

Machine 24

**T**

Technical data 97

Time and weekday 52

Troubleshooting 94

**U**

Unit amount of water/Time format 56

Use

Proper 10

**V**

Viewing information 32

**W**

Water tank 8

Descaling 71

Filling 18

## Directives

The machine complies with the following EU directives:

- 73/23/EEC of 19 February 1973, Low Voltage Directive including Amending Directive 93/68/EEC.
- 89/336/EEC of 3 May 1989, Electromagnetic Compatibility, including Amending Directive 92/31/EEC.

## Technical changes

We reserve the right to make technical changes.

The illustrations used in the IMPRESSA Z5 – Generation II Manual show the IMPRESSA Z5 – Generation II Alu model. Your IMPRESSA could incorporate minor changes.

## Feedback

Your opinion is important to us!  
Use the contact link at [www.jura.com](http://www.jura.com).

The Instructions for Use contain information which is protected by copyright. It is not permitted to photocopy or translate these Instructions for Use into another language without the express written consent of JURA Elektroapparate AG.

JURA Elektroapparate AG  
Kaffeeweltstrasse 10  
CH-4626 Niederbuchsiten

[www.jura.com](http://www.jura.com)