

# LELIT

---

Extended guide

**MARAX**

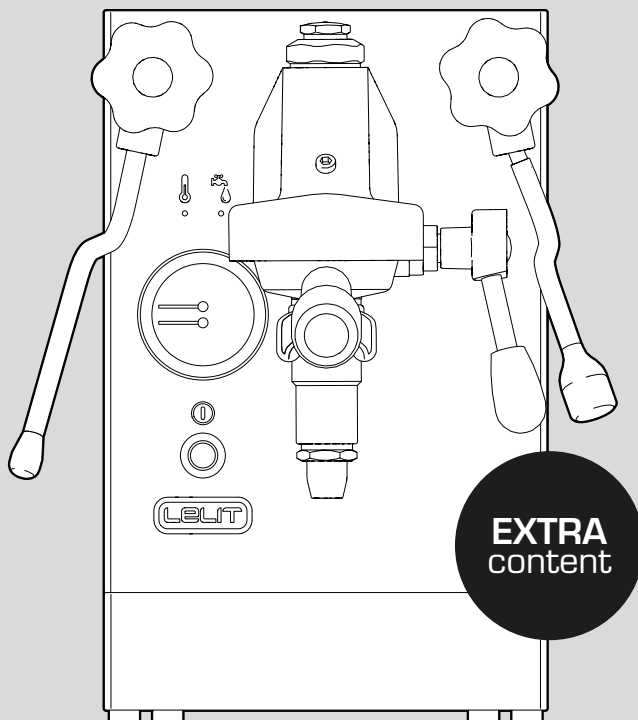

---

Pro Line  
**MaraX**  
PL62X



## THANK YOU FOR CHOOSING A LELIT PRO LINE PRODUCT

2

---

To get the most of your coffee machine PL62X  
visit our Lelit Espresso YouTube channel for  
insights, tutorials, tips and tricks.



### **Save the box and all the packaging material!**

LELIT has studied the external and internal pack-  
aging of your coffee machine to help you re-use it  
in case of maintenance or repair need.



---

# Index

---

1. Main specifications	EXTRA	4	
2. Product overview		6	
3. Factory settings		6	3 .....
4. Equipment box		7	
5. Packing		8	
6. First start-up		8	
7. How to install the water resin filter		9	
8. Espresso and coffee		10	
9. Steam and hot water		11	
10. Stand-by mode	EXTRA	12	
11. Functioning modes	EXTRA	13	
12. The art of espresso coffee		15	
13. Limestone prevention		18	
14. Daily cleaning		19	
15. Weekly cleaning		19	
16. Annual cleaning		21	
17. Pilot lights and states		21	
18. Most common problems	EXTRA	22	
19. Warranty terms		25	

# 1. Main specifications EXTRA

4  
.....



## User Friendly

This machine allows anyone to make an espresso as good as it tastes at a café by using an E61 group.



## Stainless steel

For maximum hygiene in the kitchen and easy cleaning of the appliance. A simple wipe with a sponge and your machine will shine again.



## Stainless steel boiler

The new stainless-steel boiler AISI316L is a detail aimed at improving the final result: an espresso that keeps its taste and aroma intact through each single bean from the start to the very end.



## Coffee Slide

A dispensing spout that can be used for both one or two cups and that allows the user to see the coffee cream on its way towards the cup.



## Energy saving

When the machine is not used for a long time, it automatically enters the power saving mode. This saves money for you and valuable resources for the planet.



## ATTENTION:

Read the safety notes carefully before using this product.



Pic 2

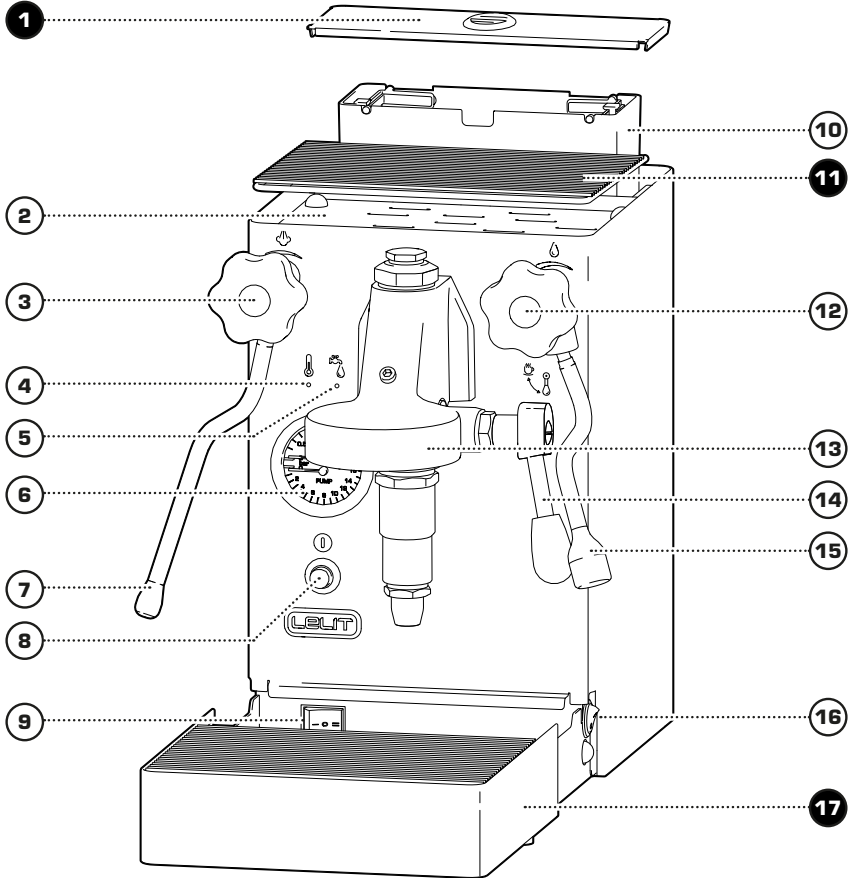

5

1 11 17

in the equipment  
box

## 2. Product overview

1. Mobile water tank cover
2. Heated surface for cup grate
3. Steam dispensing knob
4. Pilot light machine ready
5. Pilot light water tank full of water
6. Manometer for steam and pump pressure during extraction
7. Multi-directional, anti-burn steam wand
8. ON/OFF main switch (with lighted frame)
9. Temperature mode switch
10. Water tank (2,6L)
11. Grate for heated surface
12. Hot water dispensing knob
13. Brewing group
14. Coffee group lever
15. Multi-directional, anti-burn hot water wand
16. Use mode switch
17. Removable water drainage tray, complete with grate

## 3. Factory settings

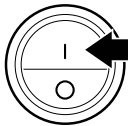

### Use mode (16)

Coffee Mode (pre-set value)

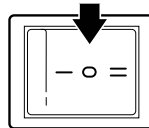

### Temperature mode (9)

Warm (pre-set value)

MaraX has 2 functioning modes: Coffee Mode that gives priority to Coffee and Steam Mode that gives priority to Steam. You can choose the right use mode for your habits and always get the best possible performance: press the switch (16) to change the functioning mode.

Both modes can run on specific temperature or pressure range: press the switch (9) to change the range.

**Read more about other functioning profiles on Chapter 11.**



**Stand by:**  
ON



**Resin filter:**  
Not inserted



## 4. Equipment box

- A.** 1 dose (9-11g) coffee filter
- B.** 2 doses PLUS (18-21g) coffee filter
- C.** Blind filter for backflushing
- D.** Tamper in stainless steel with red wood handle (PLA481R)
- E.** Raiser for espresso cups
- F.** First cleaning kit (with 3 detergent powder single-dose bags and 1 single-dose bottle)
- G.** Filterholder complete with 2 doses (14-18g) coffee filter
- H.** LELIT 35L water resin filter
- I.** Brush for group head cleaning
- J.** Plastic spoon for coffee powder
- K.** Power cord

7

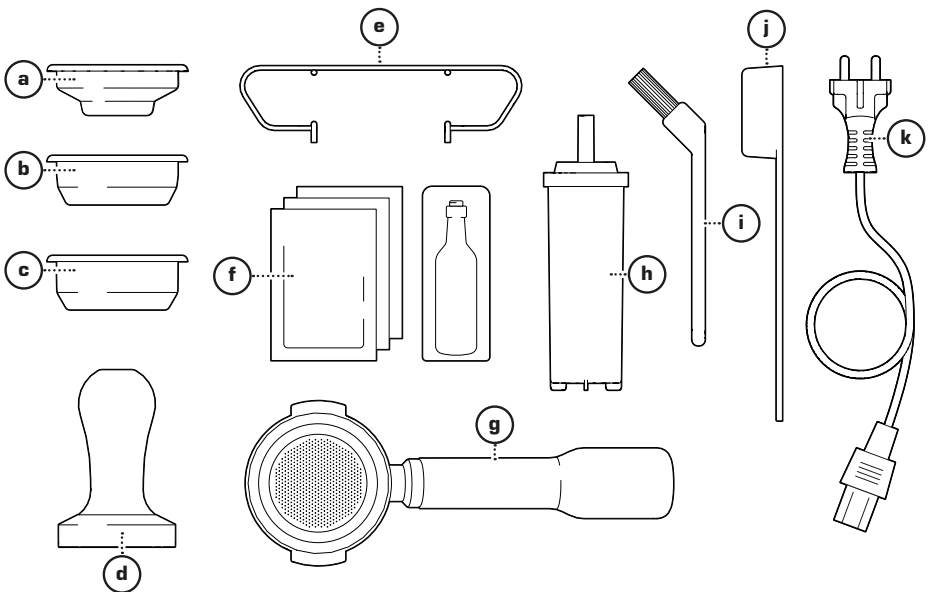

## 5. Packing

The packaging of your coffee machine has been studied and produced to be reused. Save the box and all the packaging material for the entire warranty period and, if possible, even after.

Use the original box and all the packaging elements in case you need to send the machine back to your reseller or to an authorized service centre, for ordinary or extraordinary maintenance.

On our Lelit Espresso YouTube channel you will find a video on how to pack the machine properly, using the original box and packaging material.

Please also consult your LELIT reseller before shipping the machine away and follow his eventual specific instructions.

## 6. First start-up

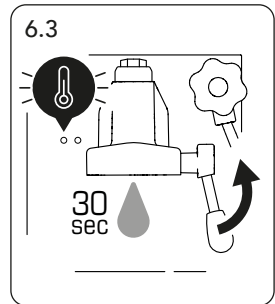
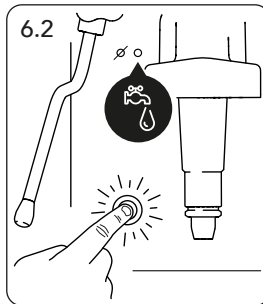
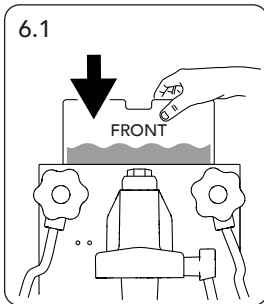

**⚠ Attention.** Remove the machine from its packing and follow the instructions printed on the box.

Place the machine on a solid, flat and dry surface and make sure the appliance is stable; if needed, screw/unscrew the feet to adjust the position of the machine.

From the equipment box, take out the water drainage tray (17), the grate (11), the mobile cover (1) and position them as indicated in Pic. 2.

**⚠ Attention.** Do not install the water filter, please run the first start-up and proceed with the water filter installation only afterwards.

Fill the water tank (10) with room temperature water up to the indicated maximum level and insert it in its seating (Pic 6.1).





Use the power cord (K) to connect the machine to the electrical mains and turn ON the machine by pressing the ON/OFF (8) switch. If the water tank (10) is full of water and properly inserted in its seating, the pilot light (5) goes ON (Pic 6.2).

The hydraulic circuit will need maximum 4 minutes from the 1st turn on to get filled with water. Once the waiting time is over, the pilot light (4) will start flashing. Lift the group lever (14) completely. The brewing group (13) will start dispensing water (within 30 seconds). Let the water come out for about 30 seconds and then return the group lever to its initial position (Pic 6.3).

Now the hydraulic circuit is filled up. The machine will start heating the water to reach the pre-set values. This operation requires maximum 24 minutes: the pilot light (5) remains firmly on, while the pilot light (4) flashes.

The machine is ready for use when the 2 pilot lights (4, 5) and the lighted frame of the ON/OFF (8) switch are firmly on.

**⚠ Attention.** *During the heating phase, a small quantity of water will drain in the tray (17). This is normal and confirms the machine correct functioning (functions check).*

**⚠ Attention.** *MaraX has all the drains into the drip tray, including the one coming from the overpressure valve. Check the drip tray, empty, and rinse it periodically!*

## 7. How to install the water resin filter

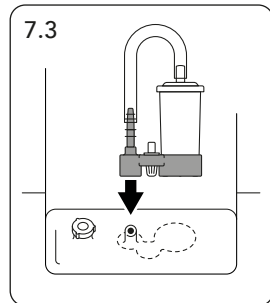
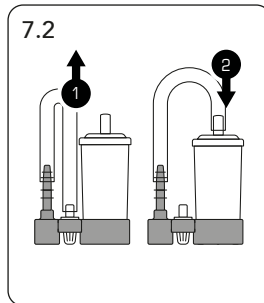

Before installing the resin filter (H) in the water tank (10), immerse the resin filter in a jug full of water for about 3 minutes, to eliminate the air inside the filter that may cause a machine malfunction (Pic 7.1).

Take out the water tank (10) and remove the black rubber support placed on the bottom of the tank. Insert the resin filter (H) in the bigger hole of the rubber support, remove the charge tube from the small plastic filter and fix it on the nozzle of the resin filter (H) (Pic 7.2).

10

Re-place the support in its seating on the bottom of the tank (Pic 7.3), fill the tank (10) with water and insert the tank (10) in its seating.

**Note.** *The Lelit water filters are composed of sodium-based cationic resins. These filters placed inside the tank filter the water and capture the calcium and magnesium salts which would normally precipitate and form scale deposits in the espresso machine circuit. Once captured, these salts liberate sodium salts: a water rich in sodium is good for the health and enhances the flavour of the coffee blend chosen for the coffee brewing.*

The Lelit water filters have a tested autonomy for 35 lt (PLA930S) and 70 lt (PLA930M): once reached this quantity of water and anyway within 4 months from the installation, the filter must be changed, because the cationic resin inside is worn out.

## 8. Espresso and coffee

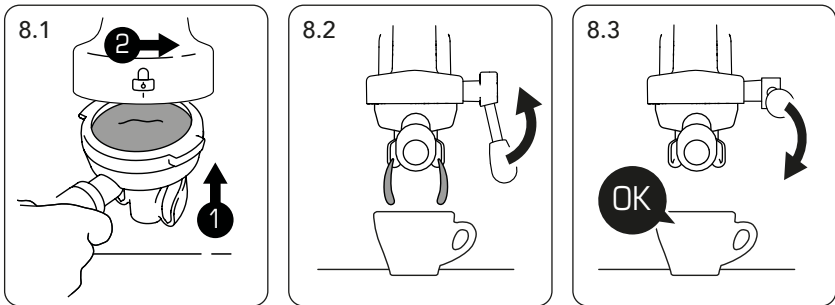

Choose your coffee filter, insert it into the portafilter (G) and fill it with the adequate quantity of ground coffee. Use the tamper (D) to press the coffee powder in the portafilter (G). Fix the portafilter (G) into the brewing group (13) and make sure the handle is aligned with padlock symbol present on the group (Pic 8.1).

Place the cup/s under the portafilter and lift the group lever (14) to start the coffee extraction (Pic 8.2).



During the extraction phase, the lighted frame of the ON/OFF switch (8) flashes to indicate that the pump works. Return the group lever (14) to its initial position to stop the extraction (Pic 8.3).

Take out the portafilter (G) and empty the filter after every coffee extraction.

**Note.** *During the normal functioning the pilot lights of the machine may flash or go off to indicate various states of the machine. See the chapter 14 “Pilot lights and states of the machine” for more details.*

**Note.** *We suggest you leave the portafilter (G) inserted into the brewing group (13) to help harmonize the temperature between the group and the portafilter complete of the filter.*

**Attention.** *Do not remove or loosen the portafilter (G) from the brewing group (13) during the coffee extraction to avoid burn risks caused by hot water leaks.*

## 9. Steam and hot water

To obtain an optimal performance of the machine, lift the group lever (14) completely and return it to its initial position about 30 seconds before using the steam wand or the hot water wand (7 or 15).

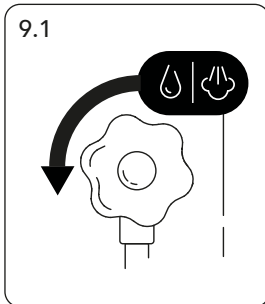

Turn the knobs (3 or 12) anticlockwise to dispense steam or hot water (Pic 9.1).

Vary the rotation of the knob to adjust the steam or hot water quantity/intensity.

Turn the knobs (3 or 12) clockwise to stop the function.

## 10. Stand-by mode EXTRA

12

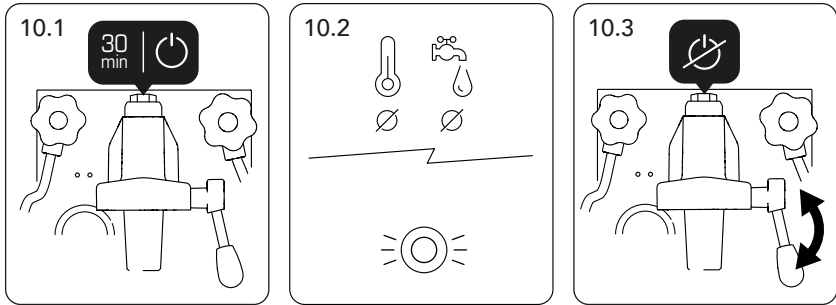

After 30 minutes of inactivity, the machine will go automatically in stand-by mode (Pic 10.1).

The lighted frame of the ON/OFF switch (8) flashes while the pilot lights (4 and 5) remain firmly off (Pic 10.2).

To re-start the machine, you must lift the group lever (14) completely and return it to its initial position (Pic 10.3).

Wait until all the pilot lights are firmly on before using the machine.

### **⚠ Disable or enable Standby function**

The Standby is normed by an EU directive for this type of coffee machine, but if you want, you can disable this function, below the procedure:

- 1.** Turn off the machine (main switch 8).
- 2.** Lift the coffee group lever (14).
- 3.** Turn on the machine (main switch 8).
- 4.** If the standby function is on, after 5 seconds the frame of the on/off switch (8) starts flashing (1 on - 1 off) and the status changes to "standby OFF"
- 5.** If the standby function is off, after 5 seconds, all lights flash to confirm the switch to active standby.
- 6.** Then switch off and on the machine to save the settings.



## 11. Functioning modes EXTRA

MaraX has 2 functioning modes: Coffee Mode that gives priority to Coffee and Steam Mode that gives priority to Steam.

13

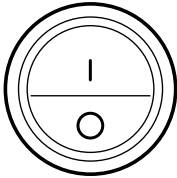

### Use mode switch (16)

You can choose the right use mode for you and always get the best possible performance: press the 2-position switch (16) to change the functioning mode.

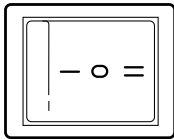

### Temperature mode switch (9)

Both modes can run on specific temperature range: press the 3-position switch (9) behind the drip tray to change the temperature range: I Hot, 0 Warm, II Extra Hot.

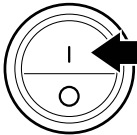



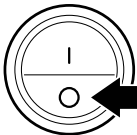







**On Coffee Mode** (factory setting) MaraX is always ready to brew coffee, with no need to flush the group as you would do with a standard E61 group: just brew your coffee or coffees and when you have finished, just clean the group.









**On Steam Mode** MaraX gives priority to steam and works like a standard HX (heat exchanger) coffee machine with PID device.

The temperatures and pressures in MaraX are electronically controlled and every switch selection has a different impact on the result and on the overall performance of the machine.

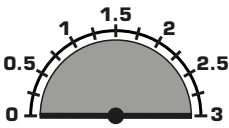
Below you will find a table indicating the 6 different functioning profiles that you can achieve with MaraX:

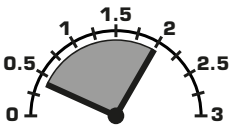
	 <p><b>COFFEE MODE</b> control coffee temperature 🕒 24 min</p>	 <p><b>STEAM MODE</b> control steam pressure 🕒 45 min</p>
	 Coffee temperature <b>WARM</b>	 Steam pressure <b>0,9 - 1,2 bar</b>
	 Coffee temperature <b>HOT</b>	 Steam pressure <b>1,1 - 1,4 bar</b>
	 Coffee temperature <b>EXTRA HOT</b>	 Steam pressure <b>1,3 - 1,6 bar</b>

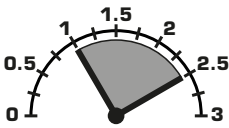
**⚠ Attention.** On Coffee Mode (factory setting) MaraX uses the temperature in the HX as reference point, therefore the steam pressure gauge may oscillate. Below a table that indicates the pressure range based on usage:

WARM UP	TEMPERATURE KEEPING	COFFEE EXTRACTION
 <p>0 - 3.2 bar</p> 	 <p>0.4 - 2 bar</p> 	 <p>1 - 2.5 bar</p> 



---

## 12. The art of espresso coffee

Contrary to what you might think, making a perfect Espresso is not that easy. It takes experience, ability, passion and a little bit of curiosity. In this paragraph we would like to share with you some of the basic rules for making a perfect cup of Espresso.

### **Suggested doses:**

Ristretto (Strong) about 20 ml – Espresso about 30 ml – Lungo (Long) about 60 ml.

15  
.....

### **The “5 M's”**

.....

If you want to make perfect Espressos, you should start by ensuring the five essential factors which turn a simple cup of coffee into an Espresso for connoisseurs! These are the “5 M's”; in Italian: *miscela* (blend), *macinatura* (grinding), *macchina* (machine), *manualità* (skill) and *manutenzione* (maintenance).

#### **1 - Miscela (Blend)**

Good Espressos are always made with a good freshly roasted and ground coffee. The freshness and the way the coffee is stored will have a dramatic affect on the taste of the coffee. There are blends and single origins all offering levels of acidity & taste experiences Try out different combinations until you find the blend you like best!

#### **2 - Macinatura (Grinding)**

The grinder is a must for making good Espresso. Coffee should always be ground just before it is used. To get the best from your Mara X you will need a good quality grinder with at least 50mm burrs and stepless adjustment

#### **3 - Macchina espresso (Espresso machine)**

Lelit machines are designed and built so that the water temperature can be adjusted to suit your needs. In addition, setting this variable correctly will allow you to extract from the ground coffee, not only the soluble substances that give it taste, but also the non-soluble ones that give body and flavour to your coffee.

#### **4 - Manualità (Skill)**

Half of the result depends on how you use the machine. A passionate expert is an essential part of the Espresso production chain and can enhance the result to bring additional value to the final product. Passion and practice are, therefore, the secrets to learning how to use the machine. You can experiment with different blends of coffee, grinding, pressing, water temperature and pressure, not just to make an Espresso, but to make the one that is just right for you.

#### **5 - Manutenzione (Maintenance)**

Daily maintenance, scheduled maintenance and care of the machine will ensure the quality of the beverage and the durability of the product you have purchased. A clean machine says a lot about your passion for coffee making.

## Coffee varieties

The choice of the blend is an essential factor for making the ideal coffee for your taste. There are a lot of different varieties of coffee blends on the market to choose from. The differences in flavour, aroma and texture depend on the quantities of the varieties of coffee that make the blend.

### Single Origins

These as the title suggests come from one origin and can vary from country to country offering different flavours levels of acidity. Have fun experimenting with different origins



**We recommend [www.TheRoastery.co.uk](http://www.TheRoastery.co.uk) freshly roasted organic coffee delivered to your door.**

No variety of coffee can make an ideal Espresso on its own. The perfect Espresso has a top layer of cream 2-3 mm thick, a nut brown to dark brown colour, with reddish tinges and light streaks, a harmonious flavour, a strong, balanced aroma and a sweet, long-lasting after-taste. It has a strong aroma with notes of flowers, fruits, toast and chocolate. These sensations can last just a moment or can persist for a few minutes in

your mouth. The taste is round and well structured. The acid and bitter perceptions are well balanced whereas there is little or no astringency.

The ideal parameters to obtain this type of coffee are:

*9 ± 0,5 g. of ground coffee.*

*25 seconds to brew 30 ml.*

*88 / 92°C when brewing and 80°C in the cup.*

*8 / 10 bar pressure during extraction.*

Even Arabica blends often contain a small amount of Robusta, which is necessary to enhance the cream and add aroma and body to the espresso.

Blends made for coffee bars usually contain 20% Robusta but in southern Italy, where they prefer a stronger taste, the percentage can reach 40-50%. At the end of the day, it's just a matter of taste...Experiment until you find the blend you like best!

## Cappuccinos

There's nothing better than a cappuccino to start your day. Although they are made and served everywhere, few people know how to make one properly.

Making the coffee is only part of this complex procedure. The froth often creates major problems, but thanks to the steam wand on our machine, with a few suggestions and a little practice you'll soon be making cappuccinos just like in the coffee bars!





### Milk and jug

You need 100 ml of milk to make a cappuccino.

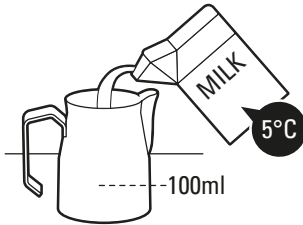

Fresh whole milk provides a smoother, creamier and tastier froth. Milk will not froth at over 65°C, so cold milk from the fridge should be used to allow more time for it to froth. The best jugs to use are made of stainless steel and have a spout, like the Lelit jug (code PLA301S – PLA301M – PLA301L - not included). The jug should never be more than half filled with milk.

### Frothing the milk

Before using the steam wand, some steam should be released for about two seconds, as it always contains some water due to condensation.

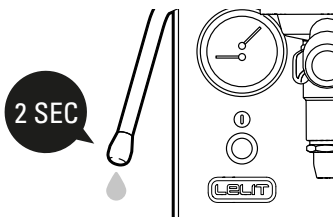

Insert the wand so that the end of the nozzle is near the side of the jug (pretend you have split the top section into four parts and insert the nozzle into one of them) and about one cen-

timetre below the surface of the milk. Since the milk will start to expand in volume, you will have to gradually lower the jug so that the nozzle is always kept immersed at the same depth. This process is complete when the milk reaches a temperature of about 37°C, or when you can feel the warmth with your hand. You can use the thermometer too (code PLA3800 - not included).

### Processing the milk

This phase is very important to make the cream thick, with a fine texture and a shiny surface.

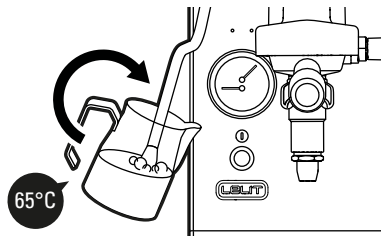

Insert the wand all the way down and tilt the jug to create a vortex. Heat the milk to the desired temperature, without exceeding 65°C. Close the steam. Prepare the milk by first tapping the jug on the countertop to remove any air bubbles and then rotating it to keep the milk and froth well amalgamated. The final result should be a smooth, creamy surface without any bubbles.

18  
.....

### Pouring the milk

You should leave the milk to settle for a least half a minute, so we suggest you always prepare it before making the coffee.

The doses for a cappuccino should be one part Espresso and two equal parts of milk and froth. Clean the steam wand with a damp cloth.

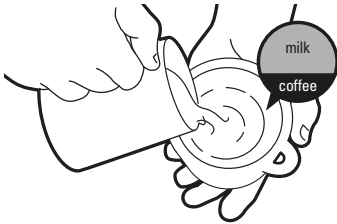

But, if you want to process the milk before making the coffee, remember to lift the group lever for 3 seconds and then bring it back in its initial position. Wait at least 30 seconds for the machine to be stable on a pressure more suitable for steam (Coffee Mode). Do this operation before using the steam wand to froth the milk!



To see the tutorial, please scan the QR-Code.

To read the QR code, download the proper app from your store.

## 13. Limestone prevention

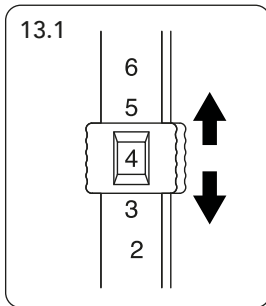

To prevent limestone deposits and grant a better result in the cup, use the water resin filter (H). The filter found in the equipment box has an autonomy tested for 35 litres of water.

Use the slides put on the handles of the water tank (10) to remember the complete fillings of the tank and replace the resin filter once exhausted (Pic 13.1).

**Note.** The resin filter must be replaced every 14 complete fillings, or after 4 months of use. If the machine remains unused for 1 month, the resin filter must be replaced with a new one.

**Note.** See chapter 6 “How to install the water resin filter” to replace the filter correctly.



## 14. Daily cleaning

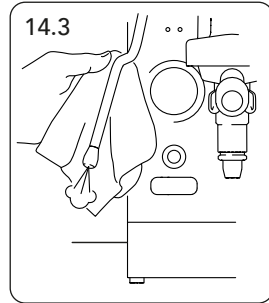
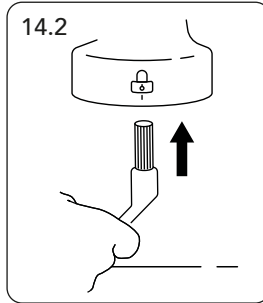
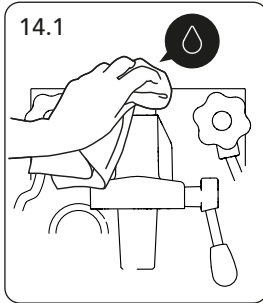

 **Note.** For an optimal result we suggest you use our kit PLA9101 (not included) that contains a microfiber cloth with embroidered LELIT logo, a paintbrush with bristles in natural fibres and a brush with nylon bristles.

**General cleaning.** Use a soft cloth, preferably in microfiber, and moisten it with tap water to clean the stainless-steel appliance body of the machine (Pic 14.1).

**Group cleaning.** After each extraction empty the coffee filter, wash the portafilter (G) and the relative filter with tap water and use the brush (I) to eliminate the coffee residues from the group gasket (Pic 14.2).

**Steam wand cleaning.** After frothing the milk, clean the nozzle of the steam wand (7) using a soft cloth and dispense a small quantity of steam to eliminate every possible milk rest in the holes (Pic 14.3).

## 15. Weekly cleaning

 **Note.** In the equipment box you'll find the detergents (F) for the first cleaning cycle of the machine. Afterwards, we suggest you use our accessories PLA9201 and PLA9203 (not included).

**Filters and portafilter cleaning.** It's necessary to clean the portafilter to eliminate the coffee oils that affect the taste of your drinks negatively. Place a jug under the hot water wand (15), turn the knob (12) anti-clockwise and take out about 1 l of water.

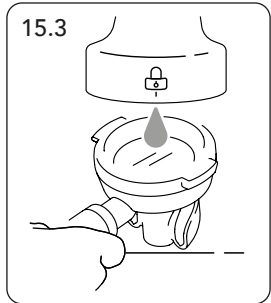
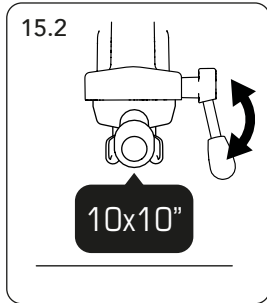
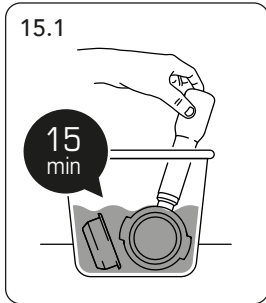

Insert the portafilter (G) and the used filters into the jug but pay attention not to immerse the portafilter handle (Pic. 15.1). Add 2 bags of detergent powder (F or PLA9201). After 15 minutes, empty the jug and rinse the portafilter (G) and the filters with plenty of tap water.

**Backflushing.** Insert the blind filter (C) into the portafilter and pour 1 bag of detergent powder (F or PLA9201) into the filter. Insert the portafilter (G) in the group (13) and lift the lever (14) for 10 seconds. Stop the function and wait for 10 seconds. Repeat the procedure 10 times (Pic 15.2).

Remove the portafilter (G) from the group and rinse it with hot water from the brewing group (Pic 15.3).

Re-insert the portafilter (G) in the group and repeat the previous operation 5 times for 10 seconds each time, without detergent powder.

Remove the portafilter (G) and take out the blind filter (C). Empty the drainage tray (17) and rinse the portafilter (G), the filters and the tray (17) with plenty of tap water.

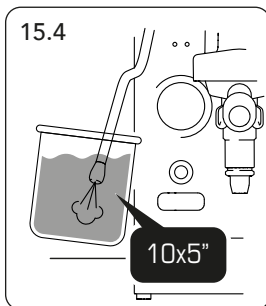

**Steam wand cleaning.** Fill a jug with 500 ml of cold water, add the content of 1 bottle of detergent liquid (F or PLA9203) and immerse the steam wand (7) in this solution.

Open the knob (3) and dispense steam for 5 seconds. Stop the function and wait for 5 seconds. Repeat the operation 10 times (Pic 15.4).

Repeat the entire procedure using 1 l of fresh water to rinse the steam wand (7) properly.



## 16. Annual cleaning

The descaling of the hydraulic circuit of the machine must be done every year to ensure longevity and constant performances. This operation must be done by a specialized technician. You can see the centres authorized to run this procedure on our website: [care.lelit.com](http://care.lelit.com).

## 17. Pilot lights and states

Pilot light is on	Pilot light flashes	Pilot light is off

			<b>State of the machine</b>
			<b>Machine in heating phase</b> Wait until the machine is ready for use
			<b>Water tank is missing or water tank is empty</b> Fill the water tank (10) with water and insert it in its seating
			<b>Machine ready for use</b> You can start using the machine
			<b>Machine in Stand-by mode</b> Lift the group lever (14) completely and return it in its initial position to activate the machine. Wait until all the pilot lights are firmly on before using the machine.
			<b>Temperature sensor NTC1 disconnected or damaged</b> Contact the service centre
			<b>Temperature sensor NTC2 disconnected or damaged</b> Contact the service centre
			<b>Boiler filling phase has exceeded the maximum time</b> Check the correct position of the water tank (10) and remove eventual blockages. Re-start the machine with the main switch. If the problem persists, contact the service centre.

## 18. Most common problems EXTRA

### 1 The lighted frame of the main switch (8) flashes continuously

---

- a. Turn the machine OFF and ON and wait for the machine to get to the right temperature (24 min).
- b. The machine goes OFF.
- c. The Standby function is ON. Follow the instruction manual to learn how to disable the function (chapter 10.1).

### 2 The coffee is too cold

---

- a. The machine needs 24 minutes to get to the right brewing temperature: the pilot light (4) will remain ON after 24 minutes.
- b. Select a higher temperature range by switching the 3-position switch (9).
- c. Do not forget to warm up the cups before the extraction: keep the cups on the top surface of the machine.
- d. Insert the filterholder without coffee into the group, lift the group lever (14) and let some hot water come out of the group head. Proceed with the coffee extraction.

### 3 The coffee is dispensed too quickly and without cream

---

- a. Grind the coffee more finely or use a finer ground coffee.
- b. Increase the coffee quantity in the filterholder.
- c. Press the coffee more firmly.
- d. Change the coffee blend.
- e. If the above suggestions do not improve the result in the cup, test the machine with the blind filter: insert the blind filter into the filterholder, fix the filterholder into the group head and lift the group lever (14). If the pump manometer reaches 9 bar (or more) it means that the machine works correctly.

### 4 The coffee is not dispensed or is only dispensed in drops

---

- a. Grind the coffee more coarsely or use a coarser ground coffee.
- b. Reduce the coffee quantity in the filterholder.
- c. Press the coffee less.
- d. If the above suggestions do not improve the result in the cup, test the machine with the blind filter: insert the blind filter into the filterholder, fix the filterholder into the group head and lift the group lever (14). If the pump manometer reaches 9 bar (or more) it means that the machine works correctly.
- e. Run a backflushing procedure to clean the essential parts of your coffee machine, see the chapter 15.



---

### **5 The coffee cream is not thick**

---

- a. Following the steps of a correct coffee extraction, try to select a higher temperature range by pressing the 3-position switch (9).
  - b. Select a suitable coffee blend knowing that a thick cream needs a good percentage of Robusta: read more about this in chapter 12.
- 

### **6 The hot water wand leaks**

---

- a. Follow the instructions below:
    1. Turn ON the machine and wait until the steam manometer indicates the pressure. Place a jug under the leaking wand and turn OFF the machine. Take care to avoid contact with water sprays.
    2. Open the water knob and let the hot water come out completely.
    3. Close the tap and turn ON the machine.
    4. Check the water wand: if the leaking persists, run a descaling procedure (contact your reseller for more details this regards).
    5. If the leaking still persists, contact your reseller to have the machine checked and repaired.
- 

### **7 No steam from the steam wand**

---

- a. Follow the instructions below:
    1. Check the pressure indicated on the steam pressure manometer: if there is no pressure, turn the machine OFF and ON and wait 10 minutes.
    - 2a. If the manometer registrates no pressure, contact your reseller for check and repair.
    - 2b. If the manometer registrates pressure, remove the wand tip and release some steam without the tip: if the steam comes out regularly, it means that the tip is blocked. Close the steam tap and clean the tip properly: make sure the holes are free.
    3. Reassemble the tip on the steam wand.
- 

### **8 No hot water from the water wand**

---

- a. Follow the instructions below:
    1. Check the pressure indicated on the steam pressure manometer: if there is no pressure turn the machine OFF and ON and wait 10 minutes.
    - 2a. If the manometer registrates no pressure, contact your reseller for check and repair.
    - 2b. If the manometer registrates pressure, remove the water aerator and release some hot water without the aerator: if the water comes out regularly, it means that the aerator is blocked. Close the water tap and clean the aerator properly.
    3. Reassemble the part on the water wand.
-

**9 The group head is just warm**

---

- a. Follow the instructions below:
1. Turn the machine OFF and ON and let some water come out from the group head.
  2. Wait 24 min to check the steam manometer.
  3. If the manometer shows 0, check the water level in the water tank and the correct position of the water tank inside the machine.
- 4a. If the manometer shows a pressure increase, press the 3-position switch (9) to select the position II. Let hot water come out from the group head (about 1 cup) and wait 24 min until the machine reaches the right temperature to brew coffee.
- 4b. If the manometer shows no pressure increase, contact your reseller for check and repair.

**10 The machine does not heat, and the pressure does not increase**

---

- a. Follow the instructions below:
1. Check the power cord and make sure it is correctly inserted into the socket.
  2. Check the water level in the water tank.
  3. Check the correct position of the water tank.
  4. Check the "water presence" pilot light (5): it has to be firmly ON.
  5. Turn the machine OFF and ON.
  6. If after 10 min the manometer registers no pressure, contact your reseller for check and repair.

**11 The drip tray fills up too quickly**

---

- a. All the drainage tubes from the boiler end up into the drip tray, therefore check the drip tray and empty it periodically.

**12 After the backflushing the group lever (14) makes a strange noise and is hard to handle**

---

- a. The backflushing procedure may remove the lubricants and the coffee oils. This does not affect the machine functioning but may cause a strange noise of the lever during handling.
- b. The lever mechanism is lubricated by the oils released during the coffee extraction; therefore, the lever will get lubricated again after 10/20 coffee extractions and the strange noise will disappear.
- c. For more details regarding the lubrication of the entire group mechanism and the suitable product to use for this procedure, please contact your reseller.
-





---

## 19. **Warranty terms**

---

### **Legal warranty**

---

This product is covered by the warranty laws valid in the country where the product has been sold; specific information about the warranty terms can be given by the seller or by the importer in the country where the product has been purchased. The seller or importer is completely responsible for the product.

The importer is completely responsible also for the fulfilment of the laws in force in the country where the importer distributes the product, including the correct disposal of the product at the end of its working life.

Inside the European countries the laws in force are the national laws implementing the EC Directive 44/99/CE.



### **IMPORTANT INFORMATION**

*For the correct disposal of the product in accordance with EU DIRECTIVE 2002/96/EC and with Legislative Decree no. 151 of 25 July 2005. At the end of its working life, the product must not be disposed of as urban waste. It must be taken to a special authorised differential waste collection centre or to a dealer providing this service. Disposing of a household appliance separately avoids possible negative consequences for the environment and health caused by improper disposal and enables recovery of the materials it contains, with significant savings in energy and resources. The product is marked with a crossed-out wheellie bin as a reminder of the need to dispose of household appliances separately.*



### **EC DECLARATION OF CONFORMITY**

*Gemme Italian Producers srl declares under its own responsibility that the product:*

*Coffee machine type: PL62X*

*to which this declaration relates conforms to the following standards:*

*EN 60335/1 - EN 60335/2/15 - EN 61000/3/2 - EN 55014*

*pursuant to directives:*

*2014/35/EU - 2014/30/EU*

*NB: This declaration is null and void should the machine be modified without our specific authorisation.*

*Castegnato, 20/02/2020 - Managing Director*

**Gemme Italian Producers srl**

**25045 Castegnato (Bs)**





espresso.lelit.com

**CE EAC**

**REV 00, dated 20/03/20**

**Art. PL62X**

©2020 Gemme Italian Producers Srl.

All Rights Reserved

.....