

jura®

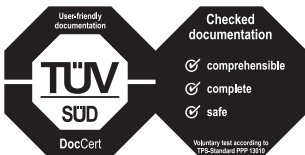

JURA J90/J95/J500 Instructions for Use



The Instructions for Use has been awarded the seal of approval by the independent German Technical Inspection Agency, TÜV SÜD, due to its easy-to-understand style, its thoroughness and coverage of safety aspects.



Your JURA J90/J95/J500

Control elements	4
Important information	6
Proper use	6
For your safety	6
1 Preparing and using for the first time	10
JURA on the Internet.....	10
Setting up the machine	10
Filling the water tank.....	10
Filling the bean container.....	10
First-time use	11
Inserting and activating the filter.....	12
Determining and adjusting the water hardness.....	13
Connecting milk.....	14
2 Preparation	15
Ways of preparing a beverage	15
Espresso and coffee	16
Preparing two speciality coffees.....	16
Latte macchiato and Cappuccino.....	16
Warm milk and milk foam.....	17
Ground coffee.....	18
Permanently setting the amount of water for the cup size	19
Adjusting the grinder	19
Hot water	20
3 Daily operation	21
Switching on the machine.....	21
Daily maintenance	21
Regular maintenance	22
Switching off the machine.....	22
4 Permanent settings in programming mode	23
Product settings	24
Maintenance settings.....	25
Energy-saving mode	26
Automatic switch-off.....	27
Unit for amount of water.....	27
Restore factory settings	28
Language.....	29
Background colour.....	29
Querying information	30



5	Maintenance	31
	Rinsing the machine.....	31
	Rinsing the cappuccino frother	32
	Cleaning the cappuccino frother.....	32
	Dismantling and rinsing the cappuccino frother	33
	Changing the filter	33
	Cleaning the machine	34
	Descaling the machine	36
	Cleaning the bean container.....	38
	Descaling the water tank.....	38
6	Display messages	39
7	Troubleshooting	40
8	Transport and environmentally friendly disposal	42
	Transport / Emptying the system.....	42
	Disposal.....	42
9	Technical data	43
10	Index	44
11	JURA contact details / Legal information	48

Symbol description

Warnings

 WARNING	Always take note of any information marked with the words CAUTION or
 CAUTION	WARNING and a warning sign. The signal word WARNING draws your attention to potential serious injury, and the signal word CAUTION to potential minor injury.
CAUTION	CAUTION draws your attention to potential damage to the machine.

Symbols used

	Prompt to take action. This symbol means that you are being prompted to perform some action.
	Information and tips to make it even easier to use your JURA.
	Display

Control elements

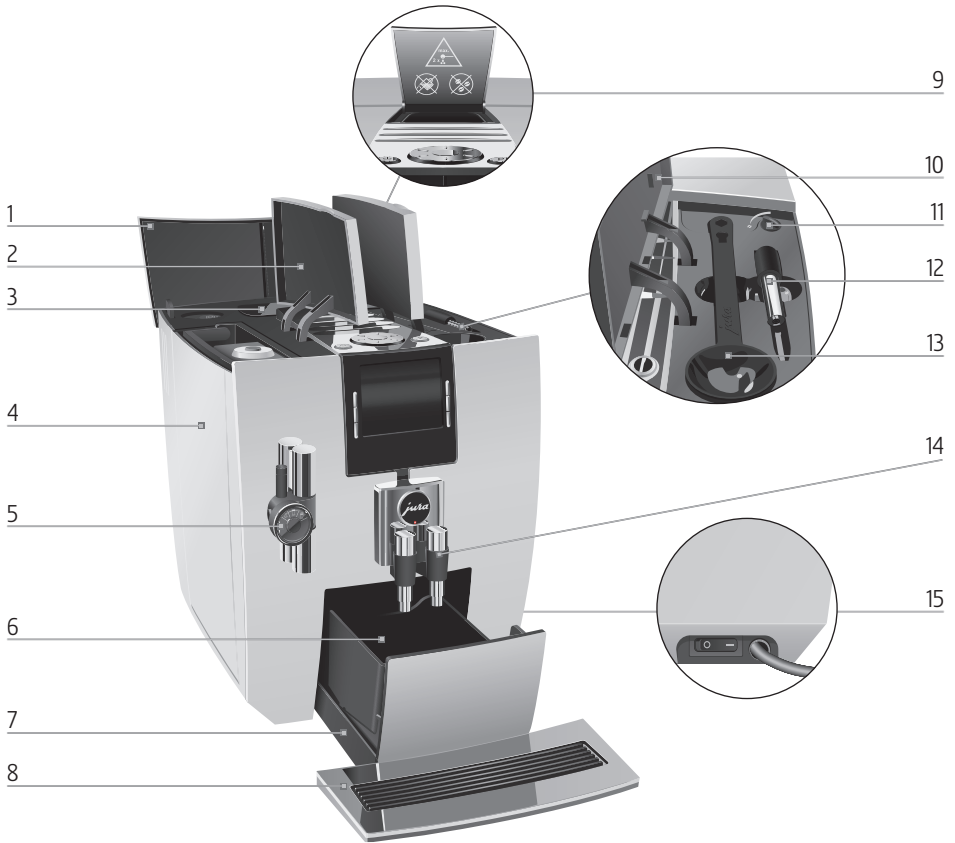



- 1 Bean container cover
- 2 Water tank cover
- 3 Bean container with aroma preservation cover
- 4 Water tank
- 5 Height-adjustable cappuccino frother
- 6 Coffee grounds container
- 7 Drip tray
- 8 Cup grille

- 9 Filler funnel for ground coffee
- 10 Storage compartment cover
- 11 Grinder adjustment switch
- 12 Hot-water nozzle*
- 13 Measuring spoon for ground coffee
- 14 Height- and width-adjustable coffee spout
- 15 Power switch and mains cable (side of machine)

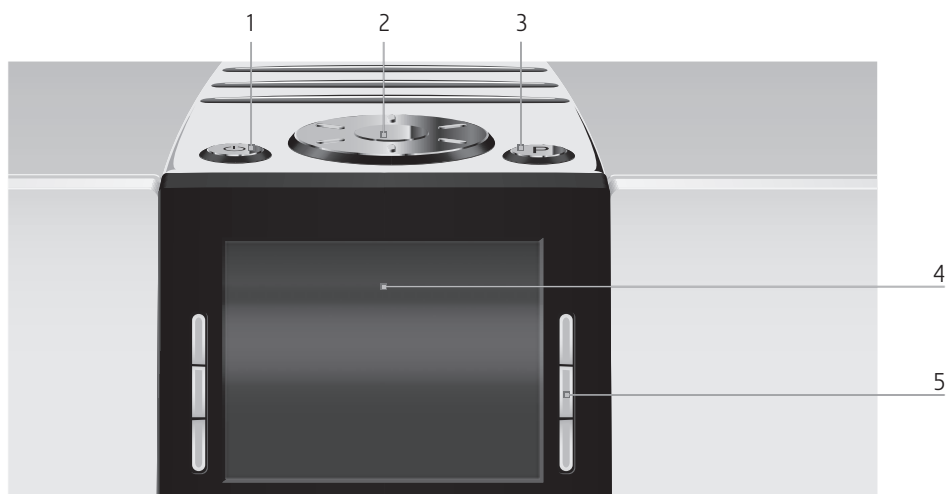

*Not on all models



Top of the machine

- 1  On/Off button
- 2  Rotary Switch
- 3  P button (programming)

Front

- 4  Display
- 5  Buttons (button function depends on what is shown in the display)

Important information

Proper use

The machine is designed and intended for private domestic use. It should only be used for coffee preparation and to heat milk and water. Use for any other purpose will be deemed improper. JURA Elektroapparate AG cannot accept any responsibility for the consequences of improper use.

Before using the machine read these instructions for use thoroughly and completely and comply with the instructions they contain. A warranty service is not applicable for damage or defects caused by non-compliance with the instructions for use. Keep these instructions for use close to the machine and pass them on to the next user.

For your safety

Please carefully read and observe the important safety information set out below.



To avoid danger of potentially fatal electric shock:

- Never use a machine which is damaged or has a defective mains cable.
- In the event of signs of damage, for example if there is a smell of burning, unplug the machine immediately from the mains supply and contact JURA service.
- If the mains cable of this machine is damaged, it must be repaired either directly by JURA or by an authorised JURA service centre.
- Make sure that the JURA and the mains cable are not located close to hot surfaces.
- Be careful to ensure that the mains cable is not trapped and does not rub against sharp edges.

- Never open and repair the machine yourself. Do not modify the machine in any way that is not described in these instructions for use. The machine contains live parts. If opened, there is a danger of potentially fatal injury. Repairs may only be carried out by authorised JURA service centres, using original spare parts and accessories.
- To completely and safely disconnect the machine from the power supply, first switch off the JURA using the On/Off button and then at the power switch. Only then should you remove the mains plug from the power socket.

There is a risk of scalds or burns on the spouts and the cappuccino frother.

- Place the machine out of the reach of children.
- Do not touch any hot parts. Use the handles provided.
- Ensure that the cappuccino frother is correctly fitted and clean. If incorrectly fitted or if they become blocked, the cappuccino frother or its parts might come off.

A defective machine is not safe and could cause injury or fire. To avoid damage and any associated risk of injury or fire:

- Never allow the mains cable to loosely hang down. The mains cable could pose a tripping hazard or become damaged.
- Protect the JURA from environmental influences such as rain, frost and direct sunlight.
- Do not immerse the JURA, mains cable or connections in water.

Important information

- Do not put the JURA or any individual parts in the dishwasher.
- Switch your JURA off at the power switch before any cleaning operation. Always wipe the JURA with a damp cloth rather than a wet one, and protect it from prolonged exposure to water splash.
- On models with glass cup grille: Do not subject the glass cup grille to shock or impact.
- Only connect the machine to the mains voltage in accordance with the information on the rating plate. The rating plate is located on the underside of your JURA. Further technical data is provided in these instructions for use (see Chapter 9 'Technical data').
- Connect the JURA directly to a domestic power socket. Using multi-socket adapters or extension cords may cause overheating.
- Please only use original JURA maintenance products. Use of products that are not explicitly recommended by JURA could damage the JURA.
- Do not use any coffee beans treated with additives or caramelised coffee beans.
- Only fill the water tank with fresh, cold water.
- Switch the machine off at the power switch if you are going to be absent for a longer period of time.
- Children may not clean or service the machine unless supervised by a responsible person.
- Do not allow children to play with the machine.
- Keep children under the age of 8 away from the machine, or supervise them constantly.

- Children aged 8 and over may only operate the machine without supervision if they have been instructed in how to use it safely. Children must be able to recognise and understand the potential dangers arising from incorrect use.

People, including children, who

- do not have the physical, sensory or mental capabilities to use the machine safely or
- are inexperienced or lack knowledge in how to use the machine safely

must be supervised by a responsible person when using it, or must be instructed in how to use it correctly.

Safety when handling the CLARIS Blue filter cartridge:

- Filter cartridges should be kept out of the reach of children.
- Store filter cartridges in a dry place in the sealed packaging.
- Protect cartridges from heat and direct sunlight.
- Do not use damaged filter cartridges.
- Do not open filter cartridges.

1 Preparing and using for the first time

JURA on the Internet

Visit us on the Internet. You can download **short operating instructions** for your machine from the JURA website (www.jura.com). You will also find interesting and up-to-date information on your JURA and on every aspect of coffee.

Setting up the machine

When setting up your JURA, please note the following:

- Place the JURA on a horizontal surface that is not sensitive to water.
- Choose a spot for your JURA which protects the machine against overheating. Ensure that the ventilation slots are not covered.

Filling the water tank

Daily maintenance of the machine and hygiene when handling milk, coffee and water are key to a perfect coffee result in the cup every time. You should therefore change the water **daily**.

CAUTION

Milk, sparkling mineral water or other liquids can damage the water tank or the machine.

- ▶ Only fill the water tank with fresh, cold water.
-
- ▶ Open the water tank cover.
 - ▶ Remove the water tank and rinse it with cold water.
 - ▶ Fill the water tank with fresh, cold water and reinsert the tank.
 - ▶ Close the water tank cover.



Filling the bean container

The bean container has an aroma preservation cover. This will ensure that your coffee beans retain their aroma for longer.

CAUTION

Coffee beans which have been treated with additives (e.g. sugar), ground coffee or freeze-dried coffee will damage the grinder.

- ▶ Only use roasted, untreated coffee beans to fill the bean container.
-
- ▶ Open the bean container cover and remove the aroma preservation cover.

- ▶ Remove any dirt or foreign objects from inside the bean container.
- ▶ Fill the bean container with coffee beans, then close the aroma preservation cover and the bean container cover.

First-time use



WARNING

If the machine is operated with a defective mains cable, there is a danger of potentially fatal electric shock.

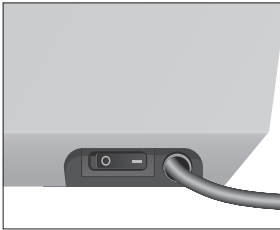
- ▶ Never use a machine which is damaged or has a defective mains cable.



Precondition: The water tank and bean container have been filled.

- ▶ Insert the mains plug into a power socket.
-  ▶ Switch on the JURA using the power switch on the right-hand side of the machine.
-  ▶ Press the On/Off button to switch the JURA on. The display shows the languages you can choose from.

i To display more languages, press the **'Next'** button (bottom right).

- ▶ Press the button that corresponds to the language you want, e.g. **'English'**. **'Saved'** appears briefly on the display to confirm the setting. **'Please press the Rotary Switch.'**, the Rotary Switch lights up.

▶ Place a receptacle under the cappuccino frother.



- ▶ Press the Rotary Switch. **'System is filling.'**, the system fills up with water. The operation stops automatically. **'Please press the Rotary Switch.'**

▶ Place a receptacle under the coffee spout.



- ▶ Press the Rotary Switch. **'Machine is rinsing.'**, the machine rinses. The operation stops automatically. **'Please select product.'** appears on the display. Your JURA is ready for use.

i The display shows the products you can prepare.

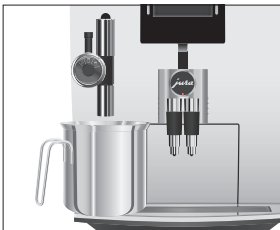

Inserting and activating the filter

Your JURA no longer has to be descaled if you are using the CLARIS Blue filter cartridge. If the water hardness is 10 °dH or more, we recommend using the filter cartridge.

- i** If you do not know the hardness of your water, you must find this out first (see Chapter 1 'Preparing and using for the first time – Determining the water hardness').
- i** Perform the 'inserting the filter' operation without any interruptions. This will ensure that your JURA always produces its best.

Precondition: 'Please select product:' is displayed.

- P** ▶ Press the P button.
'Maintenance status (1/6)'
-  ▶ Turn the Rotary Switch until the programme item 'Maintenance settings (3/6)' is displayed.
 - ▶ Press the 'Filter' button.
'Filter'
 - ▶ Press the 'Active' button.
 - ▶ Press the 'Save' button.
'Saved' appears briefly on the display.
'Insert filter'.
 - ▶ Remove the filter cartridge extension from the Welcome Pack.
 - ▶ Fit the filter extension on top of a CLARIS Blue filter cartridge.
 - ▶ Remove and empty the water tank.
 - ▶ Open the filter holder and insert the filter cartridge into the water tank, exerting slight pressure.
 - ▶ Close the filter holder. It will click into place audibly.
- i** After two months, the filter will cease to work. Set the date on the date plate on the filter holder in the water tank.
 - ▶ Fill the water tank with fresh, cold water and reinsert the tank.



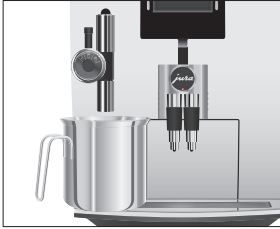

- ▶ Place a receptacle under the cappuccino frother.
 - ▶ Press the 'Next' button.
- 'Filter is being rinsed.', water flows out of the cappuccino frother.

- i** You can interrupt rinsing of the filter at any time by pressing any button. Press the Rotary Switch  to continue rinsing of the filter.
- i** The water may be slightly discoloured. This is not harmful to health and does not affect the taste.

Rinsing of the filter stops automatically after approximately 500 ml. The JURA heats up and is once more ready for use. The filter is now activated.

Determining and adjusting the water hardness

- i** If you are using the CLARIS Blue filter cartridge and have activated it in programming mode, you will not be able to adjust the water hardness.

The harder the water is, the more frequently the JURA needs to be descaled. It is therefore important to set the water hardness accurately.

The water hardness can be adjusted on a continuous scale between 1 °dH and 30 °dH.

Determining the water hardness

You can find out what the water hardness is by using the Aquadur® test strip supplied as standard.

- ▶ Hold the test strip briefly (for 1 second) under flowing water. Shake off the water.
 - ▶ Wait for about one minute.
 - ▶ You will then be able to read the degree of water hardness from the discolouration of the Aquadur® test strip and the description on the packaging.
- You can now adjust the water hardness.

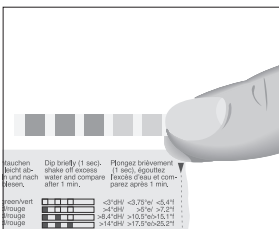

1 Preparing and using for the first time

Setting the water hardness

Example: Proceed as follows to change the water hardness from '16 °dH' to '25 °dH'.

Precondition: 'Please select product:' is displayed.

- P** ▶ Press the P button.
'Maintenance status (1/6)'
-  ▶ Turn the Rotary Switch until the programme item 'Maintenance settings (3/6)' is displayed.
 - ▶ Press the 'Water hardness' button.
'Water hardness'
 - ▶ Press the '<' or '>' button to set the water hardness.
 - ▶ Press the 'Save' button.
'Saved' appears briefly on the display to confirm the setting.
'Maintenance settings (3/6)'
- P** ▶ Press the P button to exit programming mode.
'Please select product:'

Connecting milk





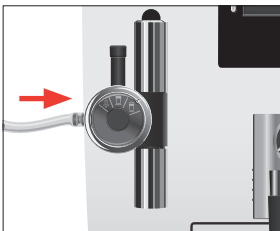
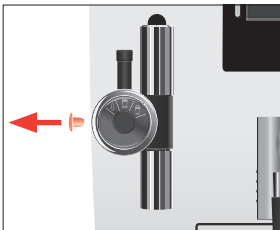

Your JURA creates fine, creamy, feather-light milk foam with a perfect consistency. The most important requirement for frothing milk is a milk temperature of 4–8 °C. We would therefore recommend using a milk cooler or a vacuum milk container.

- ▶ Remove the protective cover from the cappuccino frother.



- ▶ Attach the milk pipe to the cappuccino frother.
- ▶ Connect the other end of the milk pipe to a milk container or immerse it in a milk carton.

2 Preparation

- i** While a speciality coffee or hot water is being prepared, you can stop preparation at any time. Just press any button.
- i** During the grinding operation you can select the **coffee strength** of single products by turning the Rotary Switch :  (extra-mild),  (mild),  (normal),  (strong) or  (extra-strong).
- i** During preparation, you can change the preset **amount of water** by turning the Rotary Switch  or pressing the ‘<’ and ‘>’ buttons.
- i** You can follow the current status of preparation on the display.

You can make permanent settings for all products in programming mode (see Chapter 4 ‘Permanent settings in programming mode – Product settings’).

Ways of preparing a beverage

Only some of the speciality coffees you can prepare are shown on the display at any one time. As soon as you turn the Rotary Switch, more speciality coffees are displayed in the product selector view. The product selector view disappears automatically after 5 seconds if no preparation is started.

The following products are displayed as standard:

- ‘Cappuccino’
- ‘Latte macchiato’
- ‘1 portion milk’
- ‘Espresso’
- ‘Coffee’
- ‘Hot water’

Additional speciality coffees in the product selector view:

- ‘Ristretto’
- ‘2 ristretti’
- ‘2 espressi’
- ‘2 coffees’

Espresso and coffee

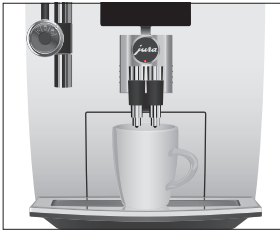

'Espresso' and 'Coffee' are prepared following this model.

Example: Proceed as follows to prepare one coffee.

- ▶ Place a cup under the coffee spout.
- ▶ Press the 'Coffee' button.
Preparation starts. The preset amount of water for coffee flows into the cup.
Preparation stops automatically. 'Please select product:' appears on the display.

Preparing two speciality coffees

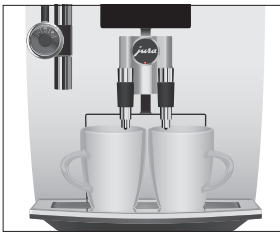

To prepare **two** speciality coffees, either use the product selector view or press the appropriate preparation button twice.

Example: Proceed as follows to prepare **two coffees** (using product selector view).

- ▶ Place two cups under the coffee spout.
- ▶ Turn the Rotary Switch to view the product selector.
- ▶ Turn the Rotary Switch until '2 coffees' is displayed.
- ▶ Press the Rotary Switch.
Preparation starts. The preset amount of water for coffee flows into the cups.
Preparation stops automatically. 'Please select product:' appears on the display.

i Proceed as follows to prepare two cups of coffee at the touch of a button: Place two cups under the coffee spout. Press the 'Coffee' button twice (**within two seconds**) to start coffee preparation.

Latte macchiato and Cappuccino

Your JURA can prepare a latte macchiato or cappuccino at the touch of a button. There is no need to move the glass or cup.

Example: Proceed as follows to prepare one latte macchiato.

Precondition: Milk is connected to the cappuccino frother.



- ▶ Place a glass under the cappuccino frother.
- ▶ Turn the setting wheel of the cappuccino frother to the Milk Foam position .
- ▶ Press the 'Latte macchiato' button.
'Latte macchiato', the milk foam is prepared.
Preparation stops automatically when the preset amount of milk is reached.

i There is a short interval while the hot milk separates from the milk foam. This allows the typical layers of a latte macchiato to form. You can choose the length of this interval in programming mode (see Chapter 4 'Permanent settings in programming mode – Product settings').

Coffee preparation starts. The preset amount of water for espresso flows into the glass. Preparation stops automatically. 'Please select product:' appears on the display.

To ensure that the cappuccino frother always works properly, you must clean it **daily** when you have been preparing milk (see Chapter 5 'Maintenance – Cleaning the cappuccino frother').

Warm milk and milk foam



Example: Proceed as follows to prepare milk foam.

Precondition: Milk is connected to the cappuccino frother.

- ▶ Place a cup under the cappuccino frother.
- ▶ Turn the setting wheel of the cappuccino frother to the Milk Foam position .

i If you want to **heat the milk** turn the setting wheel of the cappuccino frother to the Milk position .

- ▶ Press the '1 portion milk' button.
'1 portion milk'
As soon as the machine has heated up, 'Please select product:' appears.
- ▶ Press the '1 portion milk' button again.
'1 portion milk', the milk foam is prepared. Preparation stops automatically when the preset amount of milk is reached.
'Please select product:' appears on the display.

To ensure that the cappuccino frother always works properly, you must clean it **daily** when you have been preparing milk (see Chapter 5 ‘Maintenance – Cleaning the cappuccino frother’).

Ground coffee

You can choose to use a second coffee variety, for example decaffeinated coffee, with the filter funnel for ground coffee.

- i** Never add more than two level measuring spoons of ground coffee.
- i** Use ground coffee which is not ground too finely. Very fine coffee can block up the system so that the coffee only comes out in drips.
- i** If you did not fill the machine with a sufficient amount of ground coffee, ‘Not enough ground coffees’ is displayed and the JURA stops the operation.
- i** The desired speciality coffee must be prepared within approximately one minute after filling with the ground coffee. Otherwise the JURA stops the operation and is once more ready for use.

All speciality coffees with ground coffee are always prepared following the same model.

Example: Proceed as follows to prepare one coffee using ground coffee.



- ▶ Place a cup under the coffee spout.
- ▶ Open the cover of the filler funnel for ground coffee.
‘Please add ground coffee.’
- ▶ Place one level measuring spoon of ground coffee into the filler funnel.
- ▶ Close the cover of the filler funnel.
‘Please select product:’
- ▶ Press the ‘Espresso’ button.
Preparation starts. The preset amount of water for coffee flows into the cup.
Preparation stops automatically. ‘Please select product:’ appears on the display.

Permanently setting the amount of water for the cup size

It is easy to permanently adjust the amount of water for all products to the cup size. Adjust the amount once as shown in the following example. Every time you prepare a drink in the future, this amount will be dispensed.

The permanent settings for adapting the amount of water to the cup size for all speciality coffees and hot water follow this model.

Example: Proceed as follows to **permanently** set the amount of water for one coffee.

Precondition: 'Please select product:' is displayed.

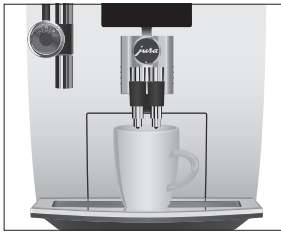

- ▶ Place a cup under the coffee spout.
- ▶ Press and **hold** the 'Coffee' button until 'Enough water? Press button' appears.
- ▶ Release the 'Coffee' button.
Preparation starts and the coffee flows into the cup.
- ▶ Press any button as soon as there is sufficient coffee in the cup.
Preparation stops. 'Saved' appears briefly on the display. The set amount of water for one coffee is permanently stored. 'Please select product:' appears on the display.

- i** You can alter this setting at any time by repeating the above procedure.
- i** The amount can be permanently adjusted to the cup size for the products shown in the product selector too. To do this, press and hold the Rotary Switch  until 'Enough water? Press button' appears.
- i** You can also permanently set the amount for all products in programming mode (see Chapter 4 'Permanent settings in programming mode – Product settings').

Adjusting the grinder

You can adjust the grinder on a continuous scale to suit the degree of roast of your coffee.

CAUTION

If you adjust the consistency of grind when the grinder is not operating, the grinder adjustment switch could be damaged.

- ▶ Only adjust the consistency of grind when the grinder is running.

2 Preparation

The consistency of grind is correct if the coffee flows regularly from the coffee spout. In addition a fine, thick crema forms.

Example: Proceed as follows to change the consistency of grind **during** the preparation of an espresso.

- ▶ Open the storage compartment cover.
- ▶ Place a cup under the coffee spout.
- ▶ Press the **'Espresso'** button.
The grinder starts up. **'Espresso'** is displayed.
- ▶ Turn the grinder adjustment switch to the desired position **while** the grinder is running.
The espresso is prepared and the consistency of grind is adjusted.
- ▶ Close the storage compartment cover.

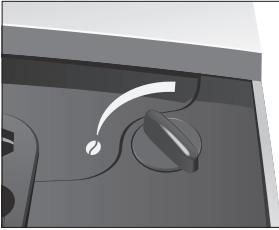

Hot water

The following temperatures can be selected for preparing hot water: **'Low'**, **'Normal'**, **'X high'**.

- i** On some models you will find a separate hot-water nozzle under the cover of the storage compartment.

⚠ CAUTION

There is a danger of scalding from hot water splashes.

- ▶ Avoid direct contact with the skin.
-
- ▶ Place a cup under the cappuccino frother.
 - ▶ Press the **'Hot water'** button.
'Hot water' and the temperature are displayed.
- i** By pressing the **'<'** or **'>'** button several times (**within approximately 2 seconds**) you can set the temperature to your individual preference. This setting is not saved.

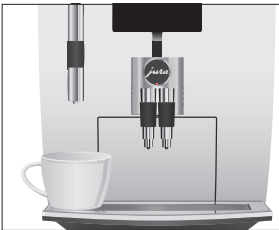

- 'Hot water'**, hot water flows into the cup.
Preparation stops automatically. **'Please select product:'** appears on the display.



3 Daily operation

Switching on the machine

When the JURA is switched on, it automatically prompts you to perform the switch-on rinse. Start the switch-on rinse by pressing the Rotary Switch . In programming mode you can change this setting so that the machine starts the switch-on rinse automatically (see Chapter 4 ‘Permanent settings in programming mode – Maintenance settings’).



Precondition: Your JURA is switched on at the power switch.

- ▶ Place a receptacle under the coffee spout.
-  ▶ Press the On/Off button to switch the JURA on.
‘Welcome to JURA’ appears on the display. The machine heats up.
‘Please press the Rotary Switch.’
-  ▶ Press the Rotary Switch.
The machine rinses. The operation stops automatically.
‘Please select product:’ appears on the display.

Daily maintenance

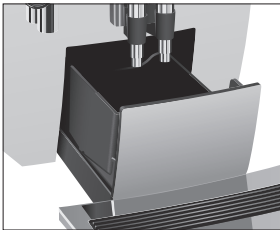

To ensure that you get many years of reliable service out of your JURA and to guarantee the optimum coffee quality, the machine requires daily maintenance.

- ▶ Pull out the drip tray.
- ▶ Empty the coffee grounds container and the drip tray. Rinse them both with warm water.
- i** Always empty the coffee grounds container when the machine is **switched on**. This is the only way of resetting the coffee grounds counter.
 - ▶ Refit the coffee grounds container and the drip tray.
 - ▶ Rinse the water tank with clean water.
 - ▶ Remove the milk pipe and rinse it thoroughly under running water.
 - ▶ Dismantle and rinse the cappuccino frother (see Chapter 5 ‘Maintenance – Dismantling and rinsing the cappuccino frother’).
 - ▶ Wipe the surface of the machine with a clean, soft, damp cloth (e.g. microfibre cloth).

Regular maintenance

Carry out the following maintenance actions **regularly** or **as required**:

- In the interests of hygiene, we recommend changing the milk pipe on a regular basis (approximately every 3 months). Replacement pipes are available from specialised dealers (JURA original accessory set for frothers).
- Clean the inside of the water tank, e.g. with a brush. Further information about the water tank is provided in these instructions for use (see Chapter 5 'Maintenance – Descaling the water tank').
- Traces of milk and coffee may stick to the top and bottom of the cup grille. If this happens, clean the cup grille.

Switching off the machine



When you switch your JURA off, the spouts used to prepare a speciality coffee or milk are rinsed.

- ▶ Place one receptacle under the coffee spout and another under the cappuccino frother.
- 🔌 ▶ Press the On/Off button.
'Machine is rinsing.', **'Milk system is being rinsed.'** The spouts used to prepare a speciality coffee or milk are rinsed. The operation stops automatically. Your JURA is switched off.

i When the JURA is switched off with the On/Off button, the machine consumes less than 0.1 W of standby energy. The machine can be completely disconnected from the power supply using the power switch.

4 Permanent settings in programming mode

Press the P button to enter programming mode. You can navigate through the programme items and permanently save the required settings simply by turning the Rotary Switch and using the multi-function buttons. The following settings can be made:

Programme item	Sub-item	Explanation
'Maintenance status (1/6)'	'Clean', 'Descale' (only if filter is not activated), 'Change the filter' (only if filter is activated), 'Switch-on rinse', 'Clean the milk system'	▶ Start the required maintenance programme here.
'Product settings (2/6)'	'Expert mode'	▶ Select your settings for speciality coffees and hot water.
'Maintenance settings (3/6)'	'Filter', 'Water hardness' (only if filter is not activated), 'Switch-on rinse', 'Rinse the milk system'	▶ Indicate whether you are operating your JURA with or without a CLARIS Blue filter cartridge. ▶ Adjust the water hardness. ▶ Change the settings for the switch-on rinse and milk system rinse.
'Machine settings 1 (4/6)'	'Save energy', 'Switch off after', 'Units', 'Factory setting'	▶ Select an energy-saving mode. ▶ Set the time after which the JURA should switch off automatically. ▶ Select the unit for the amount of water. ▶ Reset the permanently set values of all products to the factory settings.
'Machine settings 2 (5/6)'	'Choose language', 'Display', 'Colour scheme'	▶ Select your language and the background colour for the display.
'Information (6/6)'	'Product counter', 'Maintenance counter', 'Version'	▶ Keep track of all speciality coffees prepared and view the number of maintenance programmes performed.

Product settings

In the programme item **'Product settings (2/6)'** you can make individual settings for all speciality coffees and hot water. The following settings can be made:

Product	Temperature	Coffee strength	Amount
Ristretto, espresso, coffee	'Normal', 'High'	'extra-mild', 'mild', 'normal', 'strong', 'extra-strong'	Volume: '25 ml' – '240 ml'
Two ristretti, two espressi, two coffees	'Normal', 'High'	–	Volume: '25 ml' – '240 ml' (per cup)
Latte macchiato, cappuccino	'Normal', 'High'	'extra-mild', 'mild', 'normal', 'strong', 'extra-strong'	Amount of milk: '3 sec.' – '120 sec.' Interval: '0 sec.' – '60 sec.' Volume: '25 ml' – '240 ml'
Portion of milk	–	–	'3 sec.' – '120 sec.'
Hot water	'Low', 'Normal', 'X high'	–	'25 ml' – '450 ml'

Example: Proceed as follows to change the amount of milk for a latte macchiato from **'16 sec.'** to **'20 sec.'**, the interval from **'30 sec.'** to **'40 sec.'** and the amount of water from **'45 ml'** to **'40 ml'**.

Precondition: **'Please select product:'** is displayed.

P ▶ Press the P button.

'Maintenance status (1/6)'

 ▶ Turn the Rotary Switch until the programme item **'Product settings (2/6)'** is displayed.

▶ Press the **'Expert mode'** button.

'Expert mode'

i Next select the button of the product for which you would like to make settings. No product is prepared at this point.

▶ Press the **'Latte macchiato'** button.

'Latte macchiato'

▶ Press the **'Amount of milk'** button.

▶ Press the **'<'** or **'>'** button to change setting for the amount of milk to **'20 sec.'**

▶ Press the **'Save'** button.

'Saved' appears briefly on the display.

- ▶ Press the 'Volume' button.
 - ▶ Press the '<' or '>' button to change setting for the fill volume to '40 ml'.
 - ▶ Press the 'Save' button.
'Saved' appears briefly on the display.
 - ▶ Press the 'Next' button.
 - ▶ Press the 'Interval' button.
 - ▶ Press the '<' or '>' button to change setting for the interval to '40 sec.'.
 - ▶ Press the 'Save' button.
'Saved' appears briefly on the display.
'Latte macchiato'
- P** ▶ Press the P button to exit programming mode.
'Please select product:'

Maintenance settings

In the programme item 'Maintenance settings (3/6)' you can make the following settings:

- 'Filter'
 - Activate the CLARIS Blue filter cartridge (see Chapter 1 'Preparing and using for the first time – Inserting and activating the filter').
- 'Water hardness'
 - If you do not have a filter cartridge, you will need to set the water hardness (see Chapter 1 'Preparing and using for the first time – Setting the water hardness').
- 'Switch-on rinse' / 'Manual'
 - The switch-on rinse must be started manually.
- 'Switch-on rinse' / 'Automatic'
 - The switch-on rinse is started automatically.
- 'Rinse the milk system' / 'After 10 min.'
 - You are prompted to rinse the milk system 10 minutes after preparation of a speciality coffee with milk.
- 'Rinse the milk system' / 'Immediate'
 - You are prompted to rinse the milk system immediately after preparation of a speciality coffee with milk.

Example: Proceed as follows to make the machine prompt you to rinse the milk system **immediately** after preparing a speciality coffee with milk.

Precondition: 'Please select product:' is displayed.

- P ▶ Press the P button.
'Maintenance status (1/6)'
-  ▶ Turn the Rotary Switch until the programme item 'Maintenance settings (3/6)' is displayed.
 - ▶ Press the 'Rinse the milk system' button.
'Rinse the milk system'
 - ▶ Press the 'Immediate' button.
 - ▶ Press the 'Save' button.
'Saved' appears briefly on the display.
'Maintenance settings (3/6)'
- P ▶ Press the P button to exit programming mode.
'Please select product:'

Energy-saving mode

In the programme item 'Machine settings 1 (4/6)' / 'Save energy' you can permanently set an energy-saving mode:

- 'Inactive'
 - All speciality coffees, speciality coffees with milk and hot water can be prepared without having to wait.
 - The machine must heat up before milk preparation.
- 'Active' (Energy saving of up to 40%)
 - Soon after the last preparation, the JURA stops heating up. As soon as the energy-saving temperature is reached, this is indicated in the display by the message 'Energy Save' – this may take several minutes.
 - The machine must heat up before coffee, hot water or milk preparation.

Example: Proceed as follows to change the energy-saving mode from 'Inactive' to 'Active'.

Precondition: 'Please select product:' is displayed.

- P ▶ Press the P button.
'Maintenance status (1/6)'
-  ▶ Turn the Rotary Switch until the programme item 'Machine settings 1 (4/6)' is displayed.

- ▶ Press the 'Save energy' button.
'Save energy'
- ▶ Press the 'Active' button.
- ▶ Press the 'Save' button.
'Saved' appears briefly on the display.
'Machine settings 1 (4/6)'
- P ▶ Press the P button to exit programming mode.
'Please select product:'

Automatic switch-off

By instructing your JURA to automatically switch itself off, you can cut down your energy consumption. If this function is activated, your JURA switches off automatically after the preset time following the last action on the machine.

You can set the automatic switch-off time to 15 minutes or 0.5–15 hours.

Precondition: 'Please select product:' is displayed.

- P ▶ Press the P button.
'Maintenance status (1/6)'
-  ▶ Turn the Rotary Switch until the programme item 'Machine settings 1 (4/6)' is displayed.
- ▶ Press the 'Switch off after' button.
'Switch off after'
- ▶ Press the '<' or '>' button to change the setting.
- ▶ Press the 'Save' button.
'Saved' appears briefly on the display.
'Machine settings 1 (4/6)'
- P ▶ Press the P button to exit programming mode.
'Please select product:'

Unit for amount of water

You can change the unit for the amount of water from 'ml' to 'oz'.

Example: Proceed as follows to change the unit for the amount of water from 'ml' to 'oz'.

Precondition: 'Please select product:' is displayed.

- P ▶ Press the P button.
'Maintenance status (1/6)'

- ▶ Turn the Rotary Switch until the programme item **'Machine settings 1 (4/6)'** is displayed.
- ▶ Press the **'Units'** button.
- ▶ Press the **'oz'** button.
- ▶ Press the **'Save'** button.
'Saved' appears briefly on the display.
'Machine settings 1 (4/6)'
- P ▶ Press the P button to exit programming mode.
'Please select product:'

Restore factory settings

In the programme item **'Machine settings 1 (4/6)'** / **'Factory setting'** you can reset various settings to their factory settings:

- **'Machine'**
 - **All user settings** (apart from the 'filter' and 'water hardness') are reset to factory settings. Your JURA then switches off.
- **'Products'**
 - The settings (amount of water, aroma, temperature etc.) for any product can be reset **individually** to the factory settings. The corresponding double product is also reset to the factory settings at the same time.
- **'All products'**
 - The settings (amount of water, aroma, temperature etc.) for **all products** are reset to the factory settings.
- **'Display'**
 - All display settings are reset to the factory settings.

Example: Proceed as follows to reset the values for **'Espresso'** to the factory settings.

Precondition: **'Please select product:'** is displayed.

- P ▶ Press the P button.
'Maintenance status (1/6)'
- ▶ Turn the Rotary Switch until the programme item **'Machine settings 1 (4/6)'** is displayed.
- ▶ Press the **'Factory setting'** button.
'Factory setting'
- ▶ Press the **'Products'** button.

- ▶ Press the 'Espresso' button.
'Espresso' / 'Reset this product to the factory setting?'
- ▶ Press the 'Next' button.
'Saved' appears briefly on the display.
'Factory setting'
- P ▶ Press the P button to exit programming mode.
'Please select product:'

Language

In this programme item you can set the language used by your JURA.

- i** If you choose the wrong language by mistake, you can easily reset the machine to 'English': Press the P button to enter programming mode. Use the Rotary Switch  to select programme item '5/6' and then press the top left-hand button.

Example: Proceed as follows to change the language from 'English' to 'Deutsch'.

Precondition: 'Please select product:' is displayed.

- P ▶ Press the P button.
'Maintenance status (1/6)'
-  ▶ Turn the Rotary Switch until the programme item 'Machine settings 2 (5/6)' is displayed.
 - ▶ Press the 'Choose language' button.
'Choose language'
 - ▶ Press the 'Deutsch' button.
'Gespeichert' appears briefly on the display.
'Geräteeinstellungen 2 (5/6)'
- P ▶ Press the P button to exit programming mode.
'Bitte wählen Sie Ihr Produkt:'

Background colour

In this programme item you can set the background colour for the display of your JURA.

Precondition: 'Please select product:' is displayed.

- P ▶ Press the P button.
'Maintenance status (1/6)'
-  ▶ Turn the Rotary Switch until the programme item 'Machine settings 2 (5/6)' is displayed.

4 Permanent settings in programming mode

- ▶ Press the 'Colour scheme' button.
'Colour scheme'
- ▶ Press the '<' or '>' button to change the setting.
- ▶ Press the 'Save' button.
'Saved' appears briefly on the display.
'Machine settings 2 (5/6)'
- P** ▶ Press the P button to exit programming mode.
'Please select product.'

- i** The selected background colour only applies on the selection page of the display showing the speciality coffees.

Querying information

In the programme item 'Information (6/6)' you can view the following information:

- 'Product counter': Number of prepared speciality coffees, speciality coffees with milk and hot water
- 'Maintenance counter': Maintenance status and number of maintenance programmes performed (cleaning, descaling, changing the filter)
- Number of cappuccino frother cleaning operations performed
- 'Version': Software version

Precondition: 'Please select product:' is displayed.

- P** ▶ Press the P button.
'Maintenance status (1/6)'
-  ▶ Turn the Rotary Switch until the programme item 'Information (6/6)' is displayed.
- ▶ Press the 'Product counter' button.
The number of speciality coffees prepared is displayed.
- ▶ Press the 'L' button.
'Information (6/6)'
- P** ▶ Press the P button to exit programming mode.
'Please select product.'

5 Maintenance

Your JURA has the following integrated maintenance programmes:

- Rinsing the machine ('Switch-on rinse')
- Rinsing the cappuccino frother ('Rinse the milk system')
- Cleaning the cappuccino frother ('Clean the milk system')
- Changing the filter ('Change the filter')
- Cleaning the machine ('Clean')
- Descaling the machine ('Descale')

- i** Clean or descale the machine, rinse the milk system or change the filter when you are prompted to do so.
- i** Press the P button to view a list of the maintenance programmes ('Maintenance status (1/6)'). By referring to the bar you can see which maintenance programme is due. When the bar is completely filled with red, your JURA will prompt you to perform the appropriate maintenance programme.
- i** In the interests of hygiene, you should clean the milk system **daily** when you have been preparing milk.

Rinsing the machine



You can initiate the rinse operation manually at any time.

Precondition: 'Please select product:' is displayed.

- ▶ Place a receptacle under the coffee spout.
- P** ▶ Press the P button.
 - 'Maintenance status (1/6)'
- ▶ Press the 'Switch-on rinse' button.
 - 'Machine is rinsing.', water flows out of the coffee spout.
 - The rinse stops automatically. 'Please select product:' appears on the display.

Rinsing the cappuccino frother

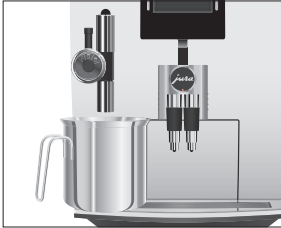

After each milk preparation, the JURA prompts you to perform a milk system rinse.

Precondition: 'Rinse the milk system' is displayed.

- ▶ Place a receptacle under the cappuccino frother.
- ▶ Press the Rotary Switch.
'Milk system is being rinsed.', water flows out of the cappuccino frother.
The rinse stops automatically. 'Please select product:' appears on the display.

Cleaning the cappuccino frother

CAUTION



To ensure that the cappuccino frother always works properly, you must clean it **daily** when you have been preparing milk.

If the wrong cleaning agent is used, the machine could be damaged and/or traces could be left behind in the water.

- ▶ Use only original JURA maintenance products.

i JURA milk system cleaner is available from specialised dealers.

Precondition: 'Please select product:' is displayed.

- P** ▶ Press the P button.
'Maintenance status (1/6)'
 - ▶ Press the 'Clean the milk system' button.
'Cleaning agent for milk system'
 - ▶ Pour 250 ml of fresh water into a receptacle and add one capful of milk system cleaner.
 - ▶ Immerse the milk pipe in the receptacle.
 - ▶ Turn the setting wheel of the cappuccino frother to the Milk Foam  or Milk  position.
 - ▶ Place another receptacle under the cappuccino frother.
 - ▶ Press the 'Next' button.
'Milk system is being cleaned.', water flows out of the cappuccino frother.
'Water for cleaning milk system'
 - ▶ Rinse the receptacle thoroughly, fill it with 250 ml of fresh water and immerse the milk pipe in the water.





Dismantling and rinsing the cappuccino frother

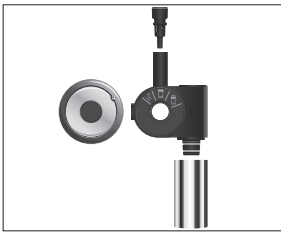

Changing the filter

- ▶ Empty the other receptacle and place it under the cappuccino frother again.
- ▶ Press the 'Next' button.
'Milk system is being cleaned.', the cappuccino frother and the pipe are rinsed with fresh water.
'Please select product:' appears on the display.

To make sure the cappuccino frother works properly, and in the interests of hygiene, it must be dismantled and rinsed **daily** if you have been preparing milk.

- ▶ Remove the milk pipe and rinse it thoroughly under running water.
- ▶ Carefully pull the cappuccino frother down and off.
- ▶ Dismantle the cappuccino frother into its individual parts.
- ▶ Rinse all the parts under running water. If there are severely dried-on milk residues, firstly immerse the individual parts in a solution of 250 ml cold water and one capful of JURA milk system cleaner. Then rinse the parts thoroughly.
- ▶ Reassemble the cappuccino frother.

- i** Ensure that all individual parts are correctly and firmly connected to ensure correct operation of the cappuccino frother.
- ▶ Firmly attach the frother to the connector.

- i** After 50 litres of water have flowed through, the filter will cease to work. Your JURA will automatically prompt you to change the filter.
- i** After two months, the filter will cease to work. Set the date on the date plate on the filter holder in the water tank.
- i** If the CLARIS Blue filter cartridge is not activated in programming mode, you will not be prompted to change the filter.

Precondition: 'Change filter' is displayed.

- P** ▶ Press the P button.
'Maintenance status (1/6)'
▶ Press the 'Change the filter' button.
'Change the filter'

i If you do not want to start changing the filter just yet, press the 'L' button. The prompt 'Change filter' remains active.

- ▶ Press the 'Next' button.
'Change filter'
- ▶ Remove and empty the water tank.
- ▶ Open the filter holder and remove the old CLARIS Blue filter cartridge and filter extension.
- ▶ Fit the filter extension on top of a **new** filter cartridge.
- ▶ Insert the filter cartridge into the water tank, exerting slight pressure.
- ▶ Close the filter holder. It will click into place audibly.
- ▶ Fill the water tank with fresh, cold water and reinsert the tank.

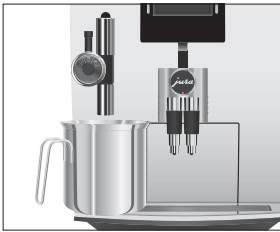

- ▶ Place a receptacle (at least 500 ml) under the cappuccino frother.
- ▶ Turn the setting wheel of the cappuccino frother to the Steam ☿ position.
- ▶ Press the 'Next' button.
'Filter is being rinsed.', water flows out of the cappuccino frother.

i You can interrupt rinsing of the filter at any time by pressing any button. Press the Rotary Switch  to continue rinsing of the filter.

i The water may be slightly discoloured. This is not harmful to health and does not affect the taste.

Rinsing of the filter stops automatically after approximately 500 ml. The JURA heats up and is once more ready for use.

Cleaning the machine

After 200 preparations or 80 switch-on rinses, the JURA will prompt you to clean it.

CAUTION

If the wrong cleaning agent is used, the machine could be damaged and/or traces could be left behind in the water.

- ▶ Use only original JURA maintenance products.
-

- i** The cleaning programme lasts approximately 20 minutes.
- i** Do not interrupt the cleaning programme. The quality of cleaning will be impaired if you do so.
- i** JURA cleaning tablets are available from specialised dealers.

Precondition: 'Clean machine' is displayed.

P ▶ Press the P button.

'Maintenance status (1/6)'

▶ Press the 'Clean' button.

'Clean'

i If you do not want to start cleaning just yet, press the 'L' button. The prompt 'Clean machine' remains active.

▶ Press the 'Next' button.

'Empty coffee grounds container'

▶ Empty the drip tray and coffee grounds container and put them back into the machine.

'Please press the Rotary Switch.'

▶ Place one receptacle under the coffee spout and another under the cappuccino frother.



▶ Press the Rotary Switch.

'Machine is being cleaned.', water flows out of the coffee spout.

The operation is interrupted, 'Add cleaning tablet'.

▶ Open the cover of the filler funnel for ground coffee.

▶ Insert a JURA cleaning tablet into the filler funnel.

▶ Close the cover of the filler funnel.

'Please press the Rotary Switch.'



▶ Press the Rotary Switch.

'Machine is being cleaned.', water flows repeatedly out of the coffee spout and the cappuccino frother.

The operation is interrupted, 'Empty coffee grounds container'.

▶ Empty the drip tray and coffee grounds container and put them back into the machine.

Cleaning is now complete. Your JURA is once more ready for use.



Descaling the machine

The JURA builds up deposits of limescale over time and automatically prompts you to descale it when necessary. The degree of calcification depends on the hardness of your water.

- ⚠ CAUTION** If the descaling agent comes into contact with the skin or eyes, this can cause irritation.
- ▶ Avoid contact with the skin or eyes.
 - ▶ Rinse off the descaling agent with clean water. Should you get any descaling agent in your eye, see a doctor.
-

- CAUTION** If the wrong descaling agent is used, the machine could be damaged and/or traces could be left behind in the water.
- ▶ Use only original JURA maintenance products.
-

- CAUTION** If the descaling operation is interrupted, there may be damage to the machine.
- ▶ Allow the descaling programme to run to the end.
-

- CAUTION** If the descaling agent comes into contact with sensitive surfaces (e.g. marble), damage cannot be ruled out.
- ▶ Clean up any splashes immediately.
-

- i** The descaling programme lasts approximately 50 minutes.
- i** JURA descaling tablets are available from specialised dealers.
- i** If you use a CLARIS Blue filter cartridge and this is activated, you will not be prompted to descale.

Precondition: 'Decalcify machine' is displayed.

- P** ▶ Press the P button.
'Maintenance status (1/6)'
- ▶ Press the 'Descal' button.
'Descal'
- i** If you do not want to start descaling just yet, press the 'L' button. The prompt 'Decalcify machine' remains active.
- ▶ Press the 'Next' button.
'Empty drip tray'
 - ▶ Empty the drip tray and coffee grounds container and put them back into the machine.
'Pour descaling agent into water tank'.

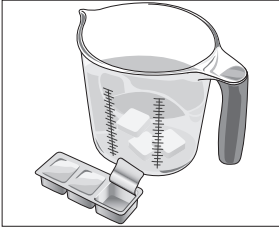

- ▶ Remove and empty the water tank.
 - ▶ Completely dissolve 3 JURA descaling tablets in a receptacle holding 500 ml of water. This may take several minutes.
 - ▶ Pour the solution into the empty water tank and insert it into the machine.
- ‘Please press the Rotary Switch.’**
- ▶ Carefully pull the cappuccino frother down and off.



- ▶ Place a receptacle under the connector of the cappuccino frother.
-  ▶ Press the Rotary Switch.
- ‘Machine is being descaled.’**, water flows repeatedly out of the connector of the cappuccino frother. The operation stops automatically, **‘Empty drip tray’**.
- ▶ Empty the receptacle under the connector of the cappuccino frother.
 - ▶ Empty the drip tray and coffee grounds container and put them back into the machine.
- ‘Fill water tank’**





- ▶ Remove the water tank and rinse it thoroughly.
 - ▶ Fill the water tank with fresh, cold water and reinsert the tank.
- ‘Please press the Rotary Switch.’**
- ▶ Refit the cappuccino frother.
 - ▶ Place one receptacle under the coffee spout and another under the cappuccino frother.
-  ▶ Press the Rotary Switch.
- ‘Machine is being descaled.’**, water flows out of the cappuccino frother and the coffee spout.
- ‘Machine is heating.’**, **‘Machine is rinsing.’**, water flows out of the coffee spout. The operation stops automatically, **‘Empty drip tray’**.
- ▶ Empty the drip tray and coffee grounds container and put them back into the machine.
- Descaling is now complete. Your JURA is once more ready for use.

i If the descaling operation stops unexpectedly, rinse the water tank thoroughly.

Cleaning the bean container

Coffee beans may be covered with a slight oil film which remains on the walls of the bean container. These traces may negatively affect the coffee result. For this reason clean the bean container from time to time.

Precondition: 'Fill bean container' is displayed.

- ▶  Switch the machine off with the On/Off button.
- ▶  Switch the machine off at the power switch.
- ▶ Open the bean container cover and remove the aroma preservation cover.
- ▶ Clean the bean container with a soft, dry cloth.
- ▶ Fill the bean container with coffee beans, then close the aroma preservation cover and the bean container cover.

Descaling the water tank

Limescale deposits may form in the water tank. To ensure correct function of the machine, descale the water tank from time to time.

- ▶ Remove the water tank.
- ▶ If you use a CLARIS Blue filter cartridge, remove this.
- ▶ Completely fill the water tank and dissolve 3 JURA descaling tablets in it.
- ▶ Leave the water tank with the descaling solution for several hours (e.g. overnight).
- ▶ Empty the water tank and rinse it thoroughly.
- ▶ If you use a CLARIS Blue filter cartridge, insert this again.
- ▶ Fill the water tank with fresh, cold water and reinsert the tank.

6 Display messages

Message	Cause/Result	Action
'Fill water tank'	The water tank is empty. You cannot prepare any products.	▶ Fill the water tank (see Chapter 1 'Preparing and using for the first time – Filling the water tank').
'Empty coffee grounds container'	The coffee grounds container is full. You cannot prepare any products.	▶ Empty the coffee grounds container and the drip tray (see Chapter 3 'Daily operation – Daily maintenance').
'Empty drip tray'	The drip tray is full. You cannot prepare any products.	▶ Empty the drip tray. ▶ Clean and dry the metal contacts on the back of the drip tray.
'Drip tray not fitted'	The drip tray is not inserted correctly or is not inserted at all. You cannot prepare any products.	▶ Fit the drip tray.
'Please press the Rotary Switch.'	The JURA is prompting you to perform a rinse or continue a maintenance programme that was already started.	▶ Press the Rotary Switch to start the rinse or to continue the maintenance programme.
'Fill bean container'	The bean container is empty. You cannot prepare any products.	▶ Fill the bean container (see Chapter 1 'Preparing and using for the first time – Filling the bean container').
'Rinse the milk system'	The JURA requests a milk system rinse.	▶ Press the Rotary Switch to start rinsing the milk system.
'Change filter'	The filter cartridge no longer works.	▶ Replace the CLARIS Blue filter cartridge (see Chapter 5 'Maintenance – Changing the filter').
'Clean machine'	The JURA is prompting you to clean it.	▶ Perform cleaning (see Chapter 5 'Maintenance – Cleaning the machine').
'Decalcify machine'	The JURA is prompting you to descale it.	▶ Perform descaling (see Chapter 5 'Maintenance – Descaling the machine').
'Not enough ground coffee'	There is insufficient ground coffee in the machine; the JURA stops the operation.	▶ The next time you prepare a beverage, add more ground coffee (see Chapter 2 'Preparation – Ground coffee').

7 Troubleshooting

Problem	Cause/Result	Action
When preparing a latte macchiato, the typical three layers do not form.	–	<ul style="list-style-type: none"> ▶ Turn the setting wheel of the cappuccino frother to the far right and the Milk Foam position . ▶ Change the length of the interval to at least 30 seconds in programming mode (see Chapter 4 'Permanent settings in programming mode – Product settings').
Insufficient foam is produced when the milk is frothed or milk sprays from the cappuccino frother.	The cappuccino frother is dirty.	<ul style="list-style-type: none"> ▶ Clean the cappuccino frother (see Chapter 5 'Maintenance – Cleaning the cappuccino frother'). ▶ Check that the air intake pipe is fitted on the cappuccino frother. ▶ Rinse or replace the air intake pipe. You will find a replacement in the Welcome Pack.
Coffee only comes out in drips when it is being prepared.	Coffee or ground coffee has been ground too finely and is blocking the system. The same filter cartridge may have been used several times or the water hardness set incorrectly in the programming mode.	<ul style="list-style-type: none"> ▶ Put the grinder on a coarser setting or use coarser ground coffee (see Chapter 2 'Preparation – Adjusting the grinder'). ▶ Perform descaling (see Chapter 5 'Maintenance – Descaling the machine').
Water hardness cannot be adjusted.	The CLARIS Blue filter cartridge is activated.	<ul style="list-style-type: none"> ▶ Deactivate the filter cartridge in programming mode.
'Fill bean container' is not displayed although the bean container is empty.	The bean monitor is dirty.	<ul style="list-style-type: none"> ▶ Clean the bean container (see Chapter 5 'Maintenance – Cleaning the bean container').
'Empty drip tray' is always displayed.	The metal contacts of the drip tray are dirty or wet.	<ul style="list-style-type: none"> ▶ Clean and dry the metal contacts on the back of the drip tray.

Problem	Cause/Result	Action
'Fill water tank' is displayed although the water tank is full.	The water tank float is trapped.	<ul style="list-style-type: none"> ▶ Descale the water tank (see Chapter 5 'Maintenance – Descaling the water tank').
Little or no water or steam comes out of the cappuccino frother. The pump is very quiet.	The connector of the cappuccino frother may be blocked by milk residues or limescale fragments loosened during descaling.	<ul style="list-style-type: none"> ▶ Remove the cappuccino frother. ▶ Unscrew the black connector with the aid of the hexagonal hole on the measuring spoon for ground coffee. ▶ Clean the connector thoroughly. ▶ Screw the connector back on by hand. ▶ Carefully tighten it using the hexagonal hole on the measuring spoon, turning by no more than a quarter of a rotation.
Grinder is making a very loud noise.	There are foreign objects in the grinder.	<ul style="list-style-type: none"> ▶ Contact customer support in your country (see Chapter 11 'JURA contact details / Legal information').
'ERROR 2' is displayed.	If the machine was exposed to the cold for a long period of time, heating is disabled for safety reasons.	<ul style="list-style-type: none"> ▶ Warm the machine at room temperature.
Other 'ERROR' messages are displayed.	–	<ul style="list-style-type: none"> ▶ Switch the JURA off at the power switch. Contact customer support in your country (see Chapter 11 'JURA contact details / Legal information').

- i** If you were unable to solve the problem, contact customer support in your country (see Chapter 11 'JURA contact details / Legal information').

8 Transport and environmentally friendly disposal

Transport / Emptying the system

In order to protect the JURA from frost during transport, the system must be emptied.



Precondition: 'Please select product:' is displayed.

- ▶ Carefully pull the cappuccino frother down and off.
- ▶ Place a receptacle under the connector of the cappuccino frother.
- ▶ Press the '1 portion milk' button.
'Machine is heating.'
- As soon as the machine has heated up, 'Please select product:' appears.
- ▶ Press the '1 portion milk' button again.
'1 portion milk', hot steam is discharged from the connector.
- ▶ Remove and empty the water tank.
- ⊗ ▶ Turn the Rotary Switch until '60 sec.' is displayed.
Steam will continue to be discharged from the connector until the system is empty.
'Fill water tank'
- ⏻ ▶ Press the On/Off button.
The JURA is switched off.

Disposal

Please dispose of old machines in an environmentally neutral way.



Old machines contain valuable, recyclable materials which should be recycled. Please therefore dispose of old machines via suitable collection systems.

9 Technical data

Voltage	220–240 V ~, 50 Hz
Power	1450 W
Conformity mark	CE
Energy consumption 'Save energy' / 'Active'	Approx. 5 Wh
Energy consumption 'Save energy' / 'Inactive'	approx. 12 Wh
Pump pressure	static, max. 15 bar
Holding capacity of water tank	2.1 l
Holding capacity of bean container	250 g
Holding capacity of coffee grounds container	max. 16 portions
Cable length	approx. 1.1 m
Weight	approx. 10.9 kg
Dimensions (W × H × D)	28.5 × 34.2 × 43.3 cm

10 Index

A

- Addresses 48
- Aroma preservation cover
 - Bean container with aroma preservation cover 4
- Automatic switch-off 27

B

- Background colour 29
- Bean container
 - Bean container with aroma preservation cover 4
 - Cleaning 38
 - Filling 10
- Bus bar
 - Technical data 43
- Button
 - On/Off button 5
 - P button (programming) 5

C

- Cappuccino 16
- Cappuccino frother
 - Cleaning 32
 - Dismantling and rinsing 33
 - Rinsing 32
- CLARIS Blue filter cartridge
 - Changing 33
 - Inserting and activating the filter 12
- Cleaning
 - Bean container 38
 - Cappuccino frother 32
 - Machine 34
- Coffee 16
- Coffee grounds container 4
- Coffee spout
 - Height- and width-adjustable coffee spout 4
- Consistency of grind
 - Adjusting the grinder 19
 - Grinder adjustment switch 4
- Contact details 48

Cover

- Bean container 4
 - Storage compartment 4
 - Water tank 4
- Cup grille 4
- Customer support 48

D

- Degree of water hardness 13
- Descaling
 - Machine 36
 - Water tank 38
- Determining and adjusting the water hardness 13
- Dismantling
 - Cappuccino frother 33
- Display 5
- Display messages 39
- Display settings 29
- Disposal 42
- Double product 16
- Drip tray 4

E

- Emptying the system 42
- Energy-saving mode 26
- Errors
 - Troubleshooting 40
- Espresso 16

F

- Factory settings
 - Restore factory settings 28
- Filler funnel
 - Filler funnel for ground coffee 4
- Filling
 - Bean container 10
 - Water tank 10
- Filter
 - Changing 33
 - Inserting and activating the filter 12
- First-time use 11
- Frother
 - Cappuccino frother 4

G

- Grinder adjustment switch 4
- Ground coffee 18
 - Measuring spoon for ground coffee 4

H

- Hotline 48
- Hot water 20
- Hot-water nozzle 4

I

- Instant coffee
 - Ground coffee 18
- Internet 10

J

- JURA
 - Contact details 48
 - Internet 10

L

- Language 29
- Latte macchiato 16

M

- Machine
 - Cleaning 34
 - Descaling 36
 - Regular maintenance 22
 - Rinsing 31
 - Setting up 10
 - Switching off 22
 - Switching on 21
- Mains cable 4
- Maintenance 31
 - Daily maintenance 21
 - Regular maintenance 22
- Maintenance settings 25
- Measuring spoon for ground coffee 4
- Messages, display 39
- Milk
 - Connecting milk 14
- Milk foam 17
- Milk system cleaning
 - Cleaning the cappuccino frother 32

- Milk system rinsing
 - Rinsing the cappuccino frother 32
- Milk, warm 17

P

- Permanently setting the water for the cup size 19
- Permanent settings in programming mode 23
- Power switch 4
- Preparation 15
 - Cappuccino 16
 - Coffee 16
 - Espresso 16
 - Ground coffee 18
 - Hot water 20
 - Latte macchiato 16
 - Milk 17
 - Two speciality coffees 16
- Problems
 - Troubleshooting 40
- Product settings 24
- Programming mode 23
 - Automatic switch-off 27
 - Background colour 29
 - Energy-saving mode 26
 - Language 29
 - Maintenance settings 25
 - Product settings 24
 - Querying information 30
 - Restore factory settings 28
 - Setting the water hardness 14
 - Unit for amount of water 27
- Proper use 6

Q

- Querying information 30

R

- Regular maintenance 22
- Rinsing
 - Cappuccino frother 32
 - Machine 31
- Rotary Switch 5

S

- Safety 6
- Safety information 6
- Settings
 - Maintenance settings 25
 - Permanent settings in programming mode 23
- Setting up
 - Setting up the machine 10
- Short operating instructions 10
- Switching off 22
- Switching on 21
- Switch-off
 - Automatic switch-off 27
- Symbol description 3

T

- Technical data 43
- Tel 48
- Transport 42
- Troubleshooting 40
- Two products 16

U

- Unit for amount of water 27
- Use, First-time 11

W

- Warm milk 17
- Water hardness
 - Determining the water hardness 13
 - Setting the water hardness 14
- Water tank 4
 - Descaling 38
 - Filling 10
- Website 10

11 JURA contact details / Legal information

JURA Elektroapparate AG
Kaffeeweltstrasse 10
CH-4626 Niederbuchsiten
Tel. +41 (0)62 38 98 233

@ You will find additional contact details for your country at
www.jura.com.

- Directives** The machine complies with the following directives:
- 2006/95/EC – Low Voltage Directive
 - 2004/108/EC – Electromagnetic Compatibility
 - 2009/125/EC – Ecodesign Directive
 - 2011/65/EU – RoHS Directive

Technical changes We reserve the right to make technical changes. The diagrams used in these instructions for use are for illustration purposes only and do not represent the original colours of the machine. Some details of your JURA may vary.

Feedback Your opinion is important to us! Use the contact details at www.jura.com.

Copyright The instructions for use contain information which is protected by copyright. It is not permitted to photocopy these instructions for use or translate them into another language without the prior written consent of JURA Elektroapparate AG.