

jura®

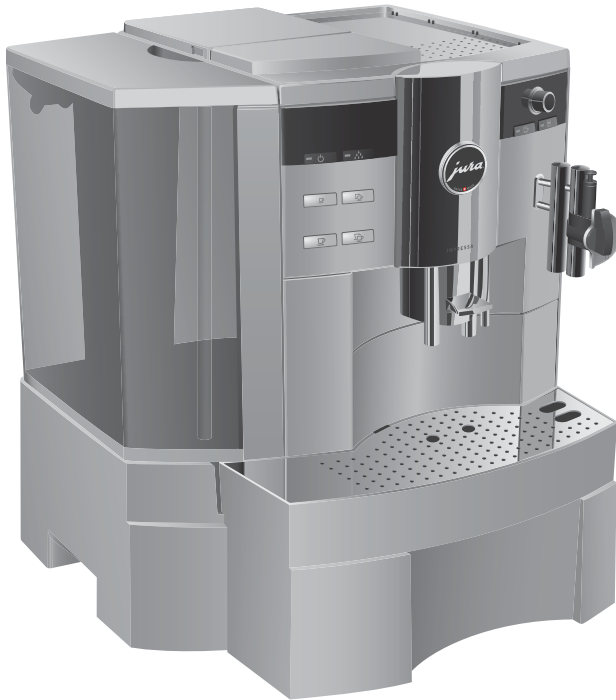

The IMPRESSA Xs95/Xs90 One Touch Manual



Original instructions for use

Before using the machine read the instructions for use.

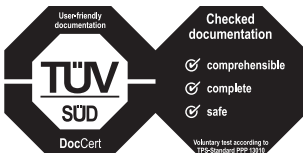

The 'IMPRESSA Manual' has been awarded the seal of approval by the independent German Technical Inspection Agency, TÜV SÜD, due to its easy-to-understand style, its thoroughness and coverage of safety aspects.

JURA Type 668

Your IMPRESSA Xs95/Xs90 One Touch

Control elements	4
Proper use	6
For your safety	6
The IMPRESSA Xs95/Xs90 One Touch Manual	8
Symbol description	8
1 Preparing and using for the first time	9
Connector System®	9
JURA on the Internet	9
Setting up	9
Filling the water tank	9
Bean container filling	10
First-time use	10
Using and activating filter	11
Determining and adjusting the degree of water hardness	12
Adjusting grinder	13
Switching on	14
Switching off	15
2 Familiarising yourself with the control options	16
Preparation at the touch of a button	16
One-off settings before and during preparation	17
Entering a permanent setting for the amount of water for a cup size	18
Permanent settings in programming mode	19
Viewing information and maintenance status	21
Counter	22
3 Preparation at the touch of a button	23
Espresso	23
Coffee	23
Coffee à la Carte	24
Latte macchiato, cappuccino	24
Pre-ground coffee	25
Hot milk and milk foam	26
Hot water	27
4 Permanent settings in programming mode	28
Products	28
Energy-saving mode (Energy Save Mode, E.S.M.®)	30
Automatic switch-off	31

Rinses	31
Restore factory settings	32
Lock.....	33
Unit amount of water.....	34
Language.....	34
5 Maintenance	36
Maintenance tips.....	36
Cleaning	the
cappuccino frother.....	36
Rinsing the machine.....	37
Rinsing the cappuccino frother	38
Disassembling and rinsing the Professional Cappuccino Frother	39
Disassembling and rinsing the Easy Cappuccino Frother.....	40
Cleaning the machine	40
Descaling the machine.....	42
Changing the filter	44
Cleaning	the
bean container.....	46
Descaling the water tank.....	47
6 Display messages	48
7 Troubleshooting	50
8 Transport and environmentally neutral disposal	52
Transport / Emptying the system.....	52
Disposal.....	52
9 Technical data	53
Index	54
JURA contact details / Legal information	56

Control elements

Control elements

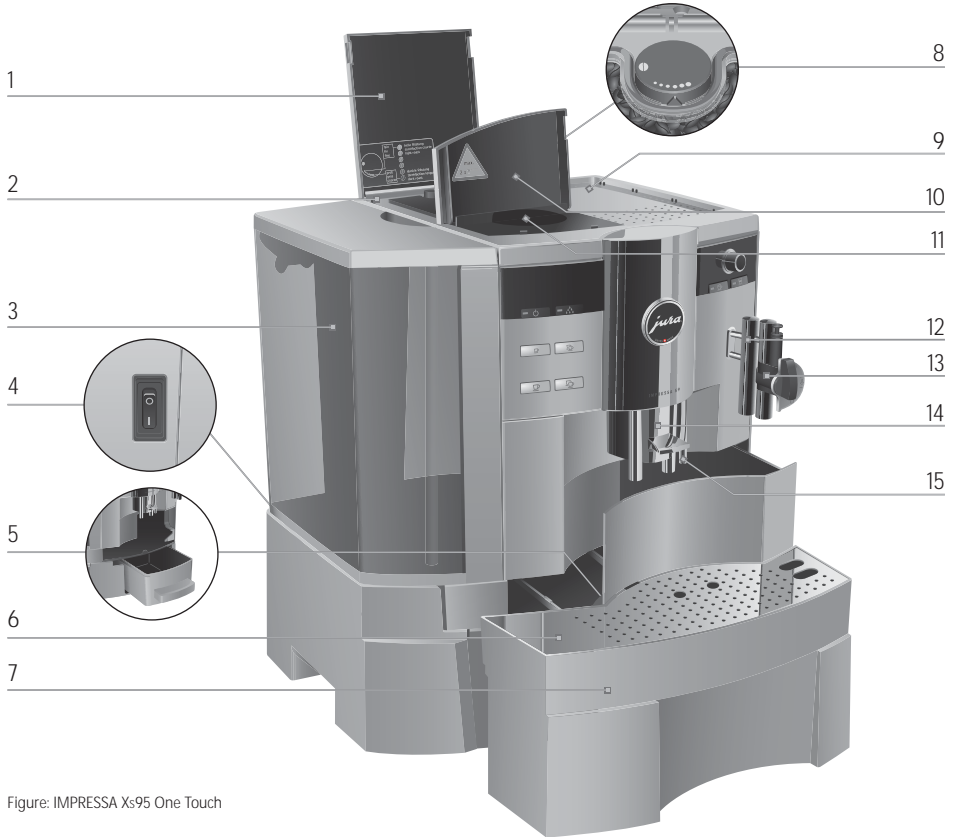









Figure: IMPRESSA Xs95 One Touch







- | | | | |
|---|--|----|--|
| 1 | Bean container cover | 8 | Fineness of grind switch |
| 2 | Bean container with aroma preservation cover | 9 | Cup tray |
| 3 | Water tank with handle | 10 | Cover of filler funnel for pre-ground coffee |
| 4 | Power switch and power cable (back of machine) | 11 | Filler funnel for pre-ground coffee |
| 5 | Coffee grounds container | 12 | Connector System [®] for removable frothers |
| 6 | Cup platform | 13 | Professional Cappuccino Frother |
| 7 | Drip tray | 14 | Height-adjustable coffee spout |
| | | 15 | Hot water spout |



Front left

- 1 Display
- 2 Rotary Switch cover
- 3  Rotary switch
-  On/off button
-  Maintenance button
-  1 Espresso button
-  2 Espresso button
-  1 Coffee button
-  2 Coffees button
-  Coffee à la Carte button
-  Pre-ground coffee button

Front right

- 4  Selector switch
- 5 Professional Cappuccino Frother
- 6 Easy Cappuccino Frother
-  Hot water portion symbol
-  Hot water symbol
-  Cappuccino button
-  Milk portion symbol
-  Milk symbol
-  Latte Macchiato button

The Connector System® permits the use of different frothers. These are available from stockists.

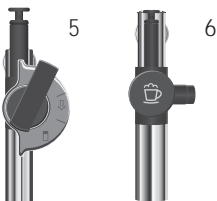

Proper use

The machine is designed and intended for commercial use. It should only be used for coffee preparation and to heat milk and water. Use for any other purpose will be deemed improper. JURA Elektroapparate AG cannot accept any responsibility for the consequences of improper use.

Before using the machine always carefully read and comply with all these instructions. Keep this manual close to the IMPRESSA and, if appropriate, pass it on to the next user.

For your safety



Please read and note carefully the following important safety information.

By doing this, you can avoid the life-threatening danger of electric shock:

- Never use a machine which has been damaged or with a defective power cable.
- For information on what to do in case of damage, for example if there is a smell of burning, unplug the machine immediately from the mains supply and contact the JURA service centre.
- If the power cable for this machine is damaged, it must be repaired either directly by JURA or by a JURA approved service centre.
- Make sure that the IMPRESSA and the power cable are not located close to hot surfaces.
- Be careful to ensure that the power cable does not get caught and does not rub against sharp edges.
- Never open and repair the machine yourself. Do not modify the machine in any way that is not described in the IMPRESSA Manual. The machine contains live parts. If opened, there is a danger of serious injury. Repairs may only be carried out by JURA approved service centres, using original spare parts and accessories.

There is a risk of scalds or burns on the spouts or in the nozzle:

- Place the machine out of the reach of children.
- Do not touch any hot parts. Use the handles provided.

- Be careful to ensure that the appropriate nozzle is installed and clean. The nozzle or parts of the nozzle might come off if the parts are not assembled correctly or a blockage occurs.

A defective machine is not safe and could cause injury or fire. To avoid damage and any associated risk of injury or fire:

- Never allow the power cable to loosely hang down. The power cable can be tripped over or damaged.
- Protect your IMPRESSA from environmental influences such as rain, frost and direct sunlight.
- Do not put the IMPRESSA, cable or connections in water.
- Do not put the IMPRESSA or any individual parts in the dishwasher.
- Turn your IMPRESSA off at the power switch before starting any cleaning operation. Always wipe your IMPRESSA with a damp cloth rather than a wet one, and protect it from prolonged water splash.
- Do not set up the IMPRESSA anywhere where a jet of water may be used.
- Only connect the machine to a power supply in accordance with the information on the rating plate. The rating plate is located on the underside of your IMPRESSA. Further technical data is given in Chapter 9 'Technical Data'.
- Use only original JURA care products. Use of accessories that are not explicitly recommended by JURA could damage the IMPRESSA.
- Do not use any coffee beans treated with additives or caramelised coffee beans.
- Always fill the water tank with cold, fresh mains water.
- If you will be absent for an extended period, turn the machine off and unplug.

Safe handling of the CLARIS filter cartridges:

- CLARIS filter cartridges should be kept out of the reach of children.
- Store them dry in the sealed package.
- Protect them from heat and direct sunlight.
- Do NOT use damaged CLARIS filter cartridges.
- Do NOT open CLARIS filter cartridges.

The IMPRESSA Xs95/Xs90 One Touch Manual

You are holding the manual for your IMPRESSA Xs95/Xs90 One Touch in your hand. It will help you to familiarize yourself with your IMPRESSA safely and quickly and teach you the full range of facilities it offers.

Chapter 1, 'Preparing and using your IMPRESSA for the first time', explains step-by-step how to set up and prepare the IMPRESSA.

Chapter 2, 'Familiarising yourself with the control options' is important for you to read as you are familiarising yourself with your IMPRESSA. It invites you to actively explore all the different coffee experiences that it offers.

All the other chapters are intended to help you when you have a specific query.

If you use the IMPRESSA Xs95/Xs90 One Touch Manual, you will become a master at preparing exciting coffee specialities, you will be a Barista!

You can download the short operating instructions for your machine from the JURA website (www.jura.com).

Symbol description

Warnings



CAUTION

Always take note of any information marked with the CAUTION or WARNING symbol. The signal word **WARNING** points out potential risk of serious injury, and the signal word **CAUTION** potential risk of slight injury.

CAUTION

The **CAUTION** symbol is used to draw attention to circumstances which could cause the machine to become damaged.

Symbols used



Information and tips to make things easier for you as you use your IMPRESSA.



References to the **online** JURA website, where you can find interesting further information: www.jura.com.



Prompt to take action. This symbol means that you are being prompted to perform some action.

1 Preparing and using for the first time

This chapter provides you with the information you need to use your IMPRESSA without any problems. You will prepare your IMPRESSA step-by-step for your first coffee experience.

Connector System®

The Connector System® permits the use of different cappuccino frothers:

- Professional Cappuccino Frother
 - Cappuccino / latte macchiato
 - Hot milk
- Easy Cappuccino Frother
 - Cappuccino / latte macchiato

JURA on the Internet

Visit us on the Internet.

- @ At www.jura.com you will find interesting and up-to-date information on your IMPRESSA and on every aspect of coffee.
- @ The Knowledge Builder awaits you at www.jura.com. The interactive assistant, LEO, will support you and explain the benefits of and how to use your IMPRESSA.

Setting up

When setting up your IMPRESSA, please note the following:

- Set the IMPRESSA down on a horizontal surface that is not sensitive to water.
- Choose a spot for your IMPRESSA which is protected against overheating. Ensure that the ventilation slots are not covered.

Filling the water tank

To enjoy perfect coffee we recommend changing the water every day.

CAUTION

Milk, mineral water or other liquids can damage the water tank or the machine.

- ▶ Only fill the water tank with fresh, cold water.
-
- ▶ Remove the water tank and rinse it with cold water.
 - ▶ Fill the water tank with fresh, cold water and reinsert.

Bean container filling

The bean container has an aroma preservation cover. This will ensure that your coffee beans retain their aroma for longer.

CAUTION

Coffee beans which have been treated with additives (e.g. sugar), pre-ground or freeze-dried coffee will damage the grinder.

- ▶ Only use untreated coffee beans to refill the bean container.
-
- ▶ Open the cover of the bean container and remove the aroma preservation cover.
 - ▶ Remove any dirt or foreign objects inside the bean container.
 - ▶ Fill the bean container with coffee beans, then close the aroma preservation cover and the bean container cover.

First-time use



WARNING

If the machine is operated with a defective power cable, there is a danger of electric shock.

- ▶ Never use a machine which has a defective power cable.

Precondition: The water tank and bean container are full.

- ▶ Insert the mains plug into a power socket.
- ▶ Switch on the IMPRESSA using the power switch on the back of the machine.
The on/off button  lights up (standby).
- ▶ Press the on/off button to switch the IMPRESSA on.
The pre-set language appears on the display.

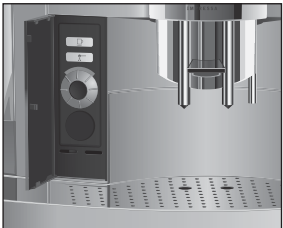

- ▶ Open the cover of the Rotary Switch.
- ▶ Turn the Rotary Switch until the desired language is displayed. For Example: **LANGUAGE ENGLISH**
- ▶ Press the Rotary Switch to confirm the language.
CONFIRMED ✓ appears briefly on the display to confirm the setting.
FILL SYSTEM / PRESS RINSE, the maintenance button  lights up.



- ▶ Place a receptacle under the hot water spout and another under the frother.
- ⚡ ▶ Press the maintenance button.
SYSTEM FILLS, the system fills up with water and the maintenance button flashes. A small amount of water flows from the frother and the hot water spout.
 This operation stops automatically. **WELCOME TO JURA** appears on the display.

HEATING UP

PRESS RINSE, the maintenance button ⚡ lights up.

- ▶ Place a receptacle under the coffee spout.
- ⚡ ▶ Press the maintenance button.
 The machine rinses itself, stopping automatically.
COFFEE READY appears on the display. Your IMPRESSA is ready to use.

- i** If you have not been able to use the machine for the first time correctly and fully, contact customer support in your country (see 'JURA contact details / Legal information').

Using and activating filter

Your IMPRESSA no longer has to be descaled if you are using CLARIS filter cartridges.

- @ You can also try out the 'Insert filter' operation online. Visit the Knowledge Builder at www.jura.com.
- i** Perform the 'Insert filter' operation without interruptions. This will ensure that your IMPRESSA always produces its best.

Precondition: **COFFEE READY** is displayed.

- ▶ Open the cover of the Rotary Switch.
- ⌚ ▶ Keep the Rotary Switch pressed **until** **MAINTENANCE** appears on the display.
- ⌚ ▶ Turn the Rotary Switch until **FILTER NO** is displayed.
- ⌚ ▶ Press the Rotary Switch to enter the programme item.
FILTER NO
- ⌚ ▶ Turn the Rotary Switch until **FILTER YES** is displayed.
- ⌚ ▶ Press the Rotary Switch to confirm the setting.
CONFIRMED ✓ appears briefly on the display to confirm the setting.

1 Preparing and using for the first time

INSERT FILTER / PRESS RINSE, the maintenance button  lights up.

- ▶ Remove a CLARIS filter cartridge and the filter cartridge extension from the Welcome Pack.
- ▶ Fit the extension on top of the filter cartridge.
- ▶ Remove the water tank and empty it.
- ▶ Lift the cartridge holder and insert the filter cartridge into the water tank, applying slight pressure.
- ▶ Close the cartridge holder. It will click into place audibly.
- ▶ Fill the water tank with fresh, cold water and reinsert.



- ▶ Place a receptacle (at least 500 ml) under the frother.

i If you are using the **Professional Cappuccino Frother**, set the selection lever of the frother to the steam position .

-  ▶ Press the maintenance button.

FILTER RINSING, water flows out of the frother.

i You can interrupt rinsing of the filter at any time by pressing any button.

i The water may be slightly discoloured. This is not harmful to health and does not affect the taste.

Filter rinsing stops automatically after approx. 500 ml.

COFFEE READY appears on the display. The filter is now activated.

Determining and adjusting the degree of water hardness

The harder the water is, the more frequently the IMPRESSA needs to be descaled. It is therefore important to adjust the water hardness.

The water hardness can be adjusted on a continuous scale between 1° dH and 30° dH. This can also be deactivated, which means that the IMPRESSA will not let you know when it has to be descaled.

i However, if you are using the CLARIS filter cartridge and have activated it, you will not be able to adjust the water hardness.







You can find out what the water hardness is by using the Aquadur® test strip supplied as standard.

- ▶ Hold the test strip briefly (for one second) under flowing water. Shake off the water.
- ▶ Wait for about one minute.
- ▶ You will then be able to read the degree of water hardness from the discolouration of the Aquadur® test strip and the description on the packaging.

You can now adjust the water hardness.

Example: To change the water hardness from 16°dH to 25°dH, proceed as follows:

Precondition: COFFEE READY is displayed.

- ▶ Open the cover of the Rotary Switch.
-  ▶ Keep the Rotary Switch pressed until MAINTENANCE appears.
-  ▶ Turn the rotary switch until HARDNESS 16°dH is displayed.
-  ▶ Press the Rotary Switch to enter the programme item.
16°dH
-  ▶ Turn the Rotary Switch until 25°dH is displayed.
-  ▶ Press the Rotary Switch to confirm the setting.
CONFIRMED ✓ appears briefly on the display.
HARDNESS 25°dH
-  ▶ Turn the Rotary Switch until EXIT is displayed.
-  ▶ Press the Rotary Switch to exit programming mode.
COFFEE READY is shown on the display.

Adjusting grinder

You can adjust the grinder continuously to suit the roast of your coffee.

CAUTION

If you adjust the fineness of grind when the grinder is not operating, the grinding wheel could be damaged.

- ▶ Only adjust the fineness of grind when the grinder is running.

The fineness of grind setting is correct if the coffee flows regularly from the coffee spout. A fine, thick crema is also formed.

1 Preparing and using for the first time

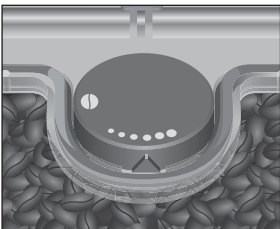
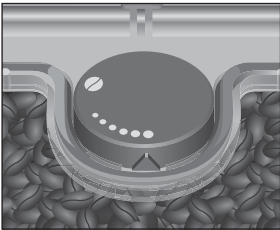
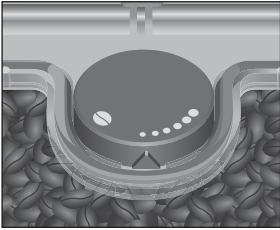

Our recommendations:

- Select a fine setting for a light roast.
 - If the fineness of grind setting is **too fine**, the coffee only drips from the coffee spout.
- Select a coarse setting for a darker roast.
 - If the fineness of grind is **too coarse** the coffee flows too quickly from the coffee spout.

Example: To change the fineness of grind **during** coffee preparation, proceed as follows:

- ▶ Open the cover of the bean container.
- ▶ Place a cup under the coffee spout.
- ☕ ▶ Press the 1 Coffee button.
 - The grinder starts and **1 COFFEE** is displayed.
 - ▶ Turn the fineness of grind switch to the desired position **while** the grinder is running.
 - The coffee will be prepared and the fineness of grind is adjusted.

Switching on

When the IMPRESSA is switched on, a prompt for the rinse operation automatically appears which is initiated by pressing the maintenance button.

This setting can be changed in programming mode so that the machine automatically activates the switch-on rinse (see Chapter 4 'Permanent settings in programming mode – Rinses').

Precondition: Your IMPRESSA is switched on at the power switch and the on/off button  is illuminated.

- ☰ ▶ Press the on/off button to switch the IMPRESSA on.
 - WELCOME TO JURA** appears briefly on the display.
 - HEATING UP**
 - PRESS RINSE**, the maintenance button  lights up.



- ▶ Place a receptacle under the coffee spout.
- ⚡ ▶ Press the maintenance button.
The machine rinses itself, stopping automatically.
COFFEE READY appears on the display. Your IMPRESSA is ready to use.

Switching off

When you switch your IMPRESSA off, the spouts with which a coffee speciality or milk have been prepared are rinsed.



- ▶ Place a receptacle under the coffee spout and the frother.
 - ⏻ ▶ Press the on/off button.
MACHINE RINSING appears on the display, and the coffee spout is rinsed.
SPOUT RIGHT / PRESS RINSE.
 - ⚡ ▶ Press the maintenance button.
MACHINE RINSING, the right coffee spout is rinsed.
The IMPRESSA is switched off, and the on/off button ⏻ lights up.
- i** When your IMPRESSA is switched off, a hissing noise may be audible. This is normal and does not have any effect on the machine.

2 Familiarising yourself with the control options

With the IMPRESSA, you can prepare an excellent coffee or milk speciality at the touch of a button. You also have the option of adjusting the coffee strength and temperature, as well as the amount of water to your personal taste.

This chapter will allow you to become familiar with all control options with the aid of examples. To familiarise yourself with your IMPRESSA, we recommend that you make a point of actively trying the facilities described in this chapter. You will find this is well worthwhile.

Learn how to perform the following:

- Preparation at the touch of a button
- One-off settings **before** and **while** your drink is being prepared
- Adjusting the default amount of water to suit the cup size
- Permanent settings in programming mode

i You can stop the machine at any time while a coffee or milk speciality or hot water is being prepared. To do this, press any button.

@ If you prefer to familiarise yourself with your IMPRESSA in a fun way on the computer, the interactive Knowledge Builder tutorial programme can be found on the Internet at www.jura.com.

Preparation at the touch of a button



Prepare your favourite coffee speciality at the touch of a button.

All coffee specialities are prepared following this model.

Example: This is how to prepare **one** coffee.

Precondition: **COFFEE READY** is displayed.

- ▶ Place a cup under the coffee spout.
- ☞ ▶ Press the 1 Coffee button.

1 COFFEE and the pre-set coffee strength is displayed.

The pre-set amount of water flows into the cup. Preparation stops automatically. **ENJOY** appears on the display.

COFFEE READY is then displayed.

i To prepare **2 coffees**, place two cups under the coffee spout and press the 2 Coffees button ☞.

One-off settings before and during preparation

It is possible to make various settings before and during preparation. These one-off settings are always follow the same model and are not stored.

Changing the coffee strength before preparation

The **coffee strength** of **Coffee à la Carte** can be changed before preparation. The following coffee strength options can be selected:

- ☉ (xmild)
- ☉☉ (mild)
- ☉☉☉ (normal)
- ☉☉☉☉ (strong)
- ☉☉☉☉☉ (xstrong)

Example: Proceed as follows to to prepare a **strong** cup of Coffee à la Carte.

Precondition: COFFEE READY is displayed.

- ▶ Place a cup under the coffee spout.
- ▶ Open the cover of the Rotary Switch.
- ☺ ▶ Press the Coffee à la Carte button.
A LA CARTE and the pre-set coffee strength is displayed.
- ☺ ▶ Turn the Rotary Switch until A LA CARTE ☉☉☉☉ is displayed.
- ☺ ▶ Turn the Rotary Switch **while** A LA CARTE ☉☉☉☉ is displayed.
A LA CARTE ☉☉☉☉, the pre-set amount of water flows into the cup. Preparation stops automatically. ENJOY appears on the display. COFFEE READY is then displayed.



Changing the amount of water during preparation

The pre-set **amount of water** of all coffee products can be changed during the brewing operation by turning the Rotary Switch.

Example: Proceed as follows to prepare a **110 ML** cup of coffee.

Precondition: COFFEE READY is displayed.

- ▶ Place a cup under the coffee spout.

2 Familiarising yourself with the control options



- ▶ Open the cover of the Rotary Switch.
- ☞ ▶ Press the 1 Coffee button.
1 COFFEE and the pre-set coffee strength is displayed. The brewing operation starts and the coffee flows into the cup.
- ☞ ▶ Turn the Rotary Switch **during** the brewing operation until **1 COFFEE / 110 ML** is displayed. The set amount of water flows into the cup. Preparation stops automatically. **ENJOY** appears on the display. **COFFEE READY** is then displayed.

Entering a permanent setting for the amount of water for a cup size

It is easy to make permanent settings for the amount of water for all coffee specialities, cappuccino, latte macchiato, a portion of hot water and portion of milk according to the cup size. As in the following example, adjust the amount of water once. Every time you prepare a drink in the future, this amount of water will be dispensed.

Making the permanent settings for the amount of water for the respective cup size always follows this model.

Example: To make **permanent** settings for the amount of water for an espresso, proceed as follows:

Precondition: **COFFEE READY** is displayed.

- ▶ Place an espresso cup under the coffee spout.
- ☞ ▶ Press and **hold** the 1 Espresso button.
1 ESPRESSO and the coffee strength is displayed.
- ☞ ▶ **Hold** the Espresso button **down** until **ENOUGH COFFEE?** appears.
- ☞ ▶ **Release** the 1 Espresso button.
Coffee preparation will start and the espresso will flow into the cup.
- ▶ Press any button as soon as enough espresso has flowed into the cup.
Preparation stops automatically. **CONFIRMED ✓** appears briefly on the display. The set amount of water for an espresso will be permanently stored. **COFFEE READY** is then displayed.

i You can alter these settings at any time by repeating the above procedure.



Permanent settings in programming mode

You can easily adjust your IMPRESSA to your personal coffee blends and specialities. You can navigate through the easy-to-understand programme steps and make permanent settings simply by turning and pressing the Rotary Switch.

You can make the following permanent settings with the Rotary Switch:

Programme item	Subitem	Explanation
MAINTENANCE	CLEAN CAPPUCCINO, RINSE MACHINE, RINSE CAPPUCCINO, CLEAN MACHINE, DECALCIFY MACHINE, CHANGE FILTER	<ul style="list-style-type: none"> ▶ Select the desired maintenance programme. <p>If no action is taken, programming mode is exited in the MAINTENANCE programme item automatically after approx. five seconds.</p>
PRODUCTS	SELECT PRODUCT	<ul style="list-style-type: none"> ▶ Select your settings for the coffee and milk specialities and hot water.
FILTER	FILTER YES FILTER NO	<ul style="list-style-type: none"> ▶ Indicate whether you operate your IMPRESSA with or without a CLARIS filter cartridge.
HARDNESS (is only displayed when the filter is not activated)	HARDNESS INACTIVE, 1 ° JH – 30 ° JH	<ul style="list-style-type: none"> ▶ Adjust the water hardness.
ECONOMY MODE	SAVE NO, SAVE LEVEL 1, SAVE LEVEL 2	<ul style="list-style-type: none"> ▶ Select an energy-saving mode.
OFF AFTER	0.5 H – 15 H	<ul style="list-style-type: none"> ▶ Set the number of hours after which the IMPRESSA should switch off automatically.
RINSES	INIT RINSE, CAPPUCCINO RINSE	<ul style="list-style-type: none"> ▶ Set whether the switch-on rinse should be started manually or automatically. ▶ Set whether the prompt for cappuccino rinsing should be started immediately or 10 minutes after preparation of a milk speciality.







2 Familiarising yourself with the control options

Programme item	Subitem	Explanation
RESET	PRODUCT, ALL PROD., ALL, EXPT.SYST.	▶ Reset the permanently set values of all products to the factory settings.
LOCK	PRODUCT, PRE-SELECT, MAINT.	▶ Lock the buttons for individual products, pre-selection of coffee strength (for coffee à la carte) or the maintenance programmes.
INFORMATION		▶ Keep track of all prepared coffee and milk specialities and view the maintenance status.
COUNTER		▶ You have the option of specifying your consumption over a timeframe determined by you. You can reset this counter to zero at any time.
SETTINGS	ML/OZ	▶ Select the unit of the amount of water.
LANGUAGE		▶ Select the desired language.
EXIT		▶ Exit programming mode.

Settings in programming mode always follow the same model.

Example: To change the strength of one espresso from **0000** (strong) to **000** (normal).

Precondition: **COFFEE READY** is displayed.

- ▶ Open the cover of the Rotary Switch.
-  ▶ Keep the Rotary Switch pressed **until** **MAINTENANCE** appears.
-  ▶ Turn the Rotary Switch until **PRODUCTS** is displayed.
-  ▶ Press the Rotary Switch to enter the programme item.
SELECT PRODUCT
-  Next select the product button for which you would like to make settings. No product is prepared during this procedure.
-  ▶ Press the 1 Espresso button.
WATER 45 ML
-  ▶ Turn the Rotary Switch until **AROMA 0000** is displayed.

- ▶ Press the Rotary Switch to enter the programme item.
STRONG ☐☐☐☐
- ▶ Turn the Rotary Switch until **NORMAL** ☐☐☐☐ is displayed.
- ▶ Press the Rotary Switch to confirm the setting.
CONFIRMED ✓ appears briefly on the display.
AROMA ☐☐☐☐
- ▶ Turn the Rotary Switch until **EXIT** is displayed.
- ▶ Press the Rotary Switch to exit the programme item.
SELECT PRODUCT
- ▶ Turn the Rotary Switch until **EXIT** is displayed.
- ▶ Press the Rotary Switch to exit the programme item.
PRODUCTS
- ▶ Turn the Rotary Switch until **EXIT** is displayed.
- ▶ Press the Rotary Switch to exit programming mode.
COFFEE READY

Viewing information and maintenance status

Under the programme item **INFORMATION** you can query the following information:



- Number of the prepared coffee and milk specialities and hot water
- Maintenance status and number of maintenance programmes performed (cleaning, descaling, filter change, Cappuccino frother cleaning)
- Software version

Precondition: **COFFEE READY** is displayed.

- ▶ Open the cover of the Rotary Switch.
- ▶ Press the Rotary Switch until **MAINTENANCE** appears.
- ▶ Turn the Rotary Switch until **INFORMATION** is displayed.
- ▶ Press the Rotary Switch to enter the programme item.
TOTAL, the sum of all prepared coffee and milk specialities is displayed.
- ▶ Turn the Rotary Switch for further information.

- i** The respective maintenance status can also be displayed in addition to the number of performed maintenance programmes. The bar shows the current maintenance status. When the bar is filled completely, your IMPRESSA will request the respective maintenance programme.

2 Familiarising yourself with the control options











-  ▶ Press the Rotary Switch to exit the programme item.
INFORMATION
-  ▶ Turn the Rotary Switch until **EXIT** is displayed.
-  ▶ Press the Rotary Switch to exit programming mode.
COFFEE READY

Counter

In the **COUNTER** programme item, you have the option of specifying your consumption over a timeframe determined by you. You can reset this counter to zero at any time.

Example: How to reset the counter to zero.

Precondition: **COFFEE READY** is displayed.

- ▶ Open the cover of the Rotary Switch.
-  ▶ Press and hold the Rotary Switch until **MAINTENANCE** appears.
-  ▶ Turn the Rotary Switch until **COUNTER** is displayed.
-  ▶ Press the Rotary Switch to enter the programme item.
TOTAL, the total number of prepared speciality coffees and milk specialities is displayed.
-  You can query more information by turning the Rotary Switch.
-  ▶ Press the Rotary Switch.
DELETE NO
-  If you do not want to reset the counter, press the Rotary Switch.
-  ▶ Turn the Rotary Switch until **DELETE YES** is displayed.
-  ▶ Press the Rotary Switch to confirm the setting.
OK appears briefly on the display.
COUNTER
-  ▶ Turn the Rotary Switch until **EXIT** is displayed.
-  ▶ Press the Rotary Switch to exit programming mode.
COFFEE READY

3 Preparation at the touch of a button

In this chapter you will find out how to prepare coffee and milk specialities and hot water without making further settings.

Chapter 2, 'Familiarising yourself with the control options', will teach you how to adjust the settings to your personal preferences. Alternatively, you can use Chapter 4, 'Permanent settings in programming mode'.

- i** You can stop the machine at any time while a coffee or milk product or hot water is being prepared. To do this, press any button.
- i** During preparation, you can change the pre-set amount of water by turning the Rotary Switch.
- @** You can also try out the preparation of coffee specialities on-line. Visit the Knowledge Builder at www.jura.com.

Espresso

The classic coffee drink from Italy. There is a definite crema on the surface of the espresso.

Example: This is how to prepare **one** espresso.

Precondition: **COFFEE READY** is displayed.

- ▶ Place an espresso cup under the coffee spout.
- ☞** ▶ Press the 1 Espresso button.
1 ESPRESSO and the pre-set coffee strength are displayed.
The pre-set amount of water flows into the cup. Preparation stops automatically. **ENJOY** appears on the display. **COFFEE READY** is then displayed.



- i** To prepare **two espressi** place two cups under the coffee spout and press the 2 Espresso button **☞**.

Coffee

Example: This is how to prepare **one** coffee.

Precondition: **COFFEE READY** is displayed.

3 Preparation at the touch of a button



- ▶ Place a coffee cup under the coffee spout.
- ☕ ▶ Press the 1 Coffee button.
1 COFFEE and the pre-set coffee strength are displayed. The pre-set amount of water flows into the cup. Preparation stops automatically. **ENJOY** appears on the display. **COFFEE READY** is then displayed.
- i** To prepare **2 coffees**, place two cups under the coffee spout and press the 2 Coffees button ☕.

Coffee à la Carte

The **coffee strength** of Coffee à la Carte can be changed **before** preparation.

Example: Proceed as follows to prepare a **strong** (☕☕☕☕) cup of Coffee à la Carte.

Precondition: **COFFEE READY** is displayed.

- ▶ Place a cup under the coffee spout.
- ▶ Open the cover of the Rotary Switch.
- ☕ ▶ Press the Coffee à la Carte button.
A LA CARTE ☕
- ⚙ ▶ Turn the Rotary Switch until **A LA CARTE ☕☕☕☕** is displayed.
- ⏻ ▶ Press the Rotary Switch **while** **A LA CARTE ☕☕☕☕** is displayed.
A LA CARTE ☕☕☕☕, the pre-set amount of water flows into the cup. Preparation stops automatically. **ENJOY** appears on the display. **COFFEE READY** is then displayed.

Latte macchiato, cappuccino

Your IMPRESSA can prepare a latte macchiato or cappuccino at the touch of a button. There is no need to move the glass or cup.



Example: Proceed as follows to prepare one latte macchiato.

Precondition: **COFFEE READY** is displayed.

- ▶ Take the protective cover off the Cappuccino Frother.
- ▶ Attach the milk pipe to the frother. For a milk carton/bottle use the long pipe, for a milk container the short pipe.
- ▶ Insert the other end into a milk carton/bottle or connect it to the milk container.





- ▶ Place a glass under the frother.
- i** If you are using the **Professional Cappuccino Frother**, set the selector switch to the Milk Foam position .
-  ▶ Press the Latte Macchiato button.
LATTE MAC and the coffee strength are displayed.
The milk foam is then prepared. The operation stops automatically when pre-set amount of milk is reached.
- i** A brief pause follows during which the hot milk separates from the milk foam. This enables the formation of the typical layers of a latte macchiato. The duration of this pause can be defined in programming mode.

Coffee preparation then begins. The pre-set amount of water flows into the glass. Preparation stops automatically. **ENJOY** appears on the display. **COFFEE READY** is then displayed.

To ensure that the frother works perfectly, you should rinse and clean it regularly. The description for this can be found in Chapter 5 'Maintenance – Cappuccino frother'.

Pre-ground coffee

You can choose a second coffee blend, for example decaffeinated coffee, with the filler funnel for pre-ground coffee.

- i** Never add more than two level measuring spoons of pre-ground coffee.
- i** Use pre-ground coffee which is not ground too finely. Very fine coffee can block up the system so that the coffee only comes out in drips.
- i** If you did not fill the machine with a sufficient amount of pre-ground coffee, **NOT ENOUGH PRE-GROUND** is displayed and the IMPRESSA stops operation.

All coffee specialities with pre-ground coffee are prepared following this model.

Example: This is how to prepare a cup of coffee using pre-ground coffee.

- ▶ Place a cup under the coffee spout.

3 Preparation at the touch of a button

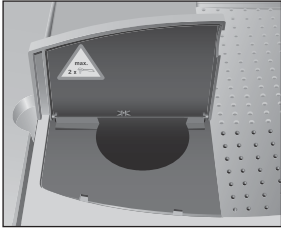



- ▶ Open the cover of the filler funnel for pre-ground coffee.
- ▶ Open the cover of the Rotary Switch.
- ▶ Press the Pre-ground coffee button.
FILL PRE-GROUND / COFFEE READY
- ▶ Place one level measuring spoon of pre-ground coffee into the filler funnel.
- ▶ Close the cover of the filler funnel for pre-ground coffee.
- ▶ Press the 1 Coffee button.
1 COFFEE, the pre-set amount of water flows into the cup. Preparation stops automatically. **ENJOY** appears on the display. **COFFEE READY** is then displayed.

Hot milk and milk foam

i This chapter applies to the **Professional** and **Easy Cappuccino Frothers**.

There are two options for preparing hot milk or milk foam:

- Milk portion 
 - The preset quantity of milk is then prepared.
- Milk 
 - Milk is prepared until preparation is interrupted by pressing any button.

Example: Proceed as follows to prepare milk foam.

Precondition: **COFFEE READY** is displayed.



- ▶ Take the protective cover off the frother.
- ▶ Attach the milk pipe to the frother. For a milk carton/bottle use the long pipe, for a milk container the short pipe.
- ▶ Insert the other end into a milk carton/bottle or connect it to the milk container.



- ▶ Place a cup under the frother.

i If you are using the **Professional Cappuccino Frother**, turn the selector switch to the Milk Foam position .

i If you want to **heat the milk**, turn the selector switch of the Professional Cappuccino Frother to the Milk position .



-  ▶ With the selector switch select the milk portion symbol .

- ▶ Press the selector switch.
MILK, the milk foam is being prepared. Preparation stops automatically when the pre-set amount of milk is reached.
COFFEE READY is shown on the display.

To ensure that the frother works perfectly, you should rinse and clean it regularly. The description for this can be found in Chapter 5 'Maintenance – Cappuccino frother'.

Hot water

Hot water can be prepared in two ways:

- Hot water portion 
 - The pre-set amount of water flows into the cup.
- Hot water 
 - Water flows out of the hot water spout until preparation is interrupted by pressing any button.

The following temperatures can be selected for preparing hot water:

- Low
- Normal
- X high





CAUTION

There is a danger of scalding from hot water splashes.

- ▶ Avoid direct contact with the skin.
-

Example: This is how to prepare a **portion** of hot water.

Precondition: **COFFEE READY** is displayed.

- ▶ Place a cup under the hot water spout.
-  ▶ Use the selector switch to select the hot water portion symbol .
-  ▶ Press the selector switch.
TEMPERATURE and the pre-set temperature are displayed.

- i** By pressing the selector switch several times (**within approx. 2 seconds**) you can set the temperature to your individual preference. This setting is not saved.

HOT WATER, the pre-set amount of water flows into the cup. Preparation stops automatically. **COFFEE READY** appears on the display.



4 Permanent settings in programming mode

Products

With the **PRODUCTS** programme item you can enter individual settings for all coffee and milk specialities as well as hot water.

The following permanent settings can be made:





















Product	Amount	Coffee strength	Temp.
1 Espresso, 1 Coffee	25 ML – 240 ML	☉ (xmild), ☉☉ (mild), ☉☉☉ (normal), ☉☉☉☉ (strong), ☉☉☉☉☉ (xstrong)	NORMAL, HIGH
2 Espresso, 2 Coffees	25 ML – 240 ML (per cup)	–	NORMAL, HIGH
Coffee à la Carte	25 ML – 240 ML	–	NORMAL, HIGH
Latte macchiato, Cappuccino	Amount of milk: 3 SEC – 120 SEC Pause: 0 SEC – 60 SEC Amount of water: 25 ML – 240 ML	☉ (xmild), ☉☉ (mild), ☉☉☉ (normal), ☉☉☉☉ (strong), ☉☉☉☉☉ (xstrong)	NORMAL, HIGH
Milk portion	3 SEC – 120 SEC	–	–
Milk	–	–	–
Hot water portion	25 ML – 450 ML	–	LOW, NORMAL, X HIGH
Hot water	–	–	LOW, NORMAL, X HIGH

Permanent settings in programming mode always follow the same model.

Example: Proceed as follows to change the amount of milk of latte macchiato from 16 SEC to 20 SEC, the pause from 30 SEC to 40 SEC and the amount of water from 45 ML to 40 ML.

Precondition: **COFFEE READY** is displayed.

- ▶ Open the cover of the Rotary Switch.
- ▶ Keep the Rotary Switch pressed **until** **MAINTENANCE** appears.
- ▶ Turn the Rotary Switch until **PRODUCTS** is displayed.

-  ▶ Press the Rotary Switch to enter the programme item.
`SELECT PRODUCT`
-  Next select the product button for which you would like to make settings. No product is prepared during this procedure.
-  ▶ Press the Latte Macchiato button.
`COFFEE 45 ML`
-  ▶ Press the Rotary Switch to enter the programme item.
`COFFEE 45 ML`
-  ▶ Turn the Rotary Switch until `COFFEE 40 ML` is displayed.
-  ▶ Press the Rotary Switch to confirm the setting.
`CONFIRMED ✓` appears briefly on the display.
`COFFEE 40 ML`
-  ▶ Turn the Rotary Switch until `MILK 15 SEC` is displayed.
-  ▶ Press the Rotary Switch to enter the programme item.
`MILK 15 SEC`
-  ▶ Turn the Rotary Switch until `MILK 20 SEC` is displayed.
-  ▶ Press the Rotary Switch to confirm the setting.
`CONFIRMED ✓` appears briefly on the display.
`MILK 20 SEC`
-  ▶ Turn the Rotary Switch until `PAUSE 30 SEC` is displayed.
-  ▶ Press the Rotary Switch to enter the programme item.
`PAUSE 30 SEC`
-  ▶ Turn the Rotary Switch until `PAUSE 40 SEC` is displayed.
-  ▶ Press the Rotary Switch to confirm the setting.
`CONFIRMED ✓` appears briefly on the display.
`PAUSE 40 SEC`
-  ▶ Turn the Rotary Switch until `EXIT` is displayed.
-  ▶ Press the Rotary Switch to exit the programme item.
`SELECT PRODUCT`
-  ▶ Turn the Rotary Switch until `EXIT` is displayed.
-  ▶ Press the Rotary Switch to exit the programme item.
`PRODUCTS`
-  ▶ Turn the Rotary Switch until `EXIT` is displayed.
-  ▶ Press the Rotary Switch to exit programming mode.
`COFFEE READY`

Energy-saving mode (Energy Save Mode, E.S.M.®)

You can also set various energy-saving modes on your IMPRESSA:

- **SAVE NO**
 - Your IMPRESSA is continuously ready for use.
 - All coffee and milk products, as well as hot water, can be prepared without having to wait.
- **SAVE LEVEL 1**
 - Your IMPRESSA is only continuously ready for use for coffee products and hot water.
 - The machine has to heat up before milk preparation.
- **SAVE LEVEL 2**
 - Approx. 5 minutes after the last preparation the IMPRESSA switches to the energy-saving temperature and is not ready for use.
 - Before coffee, hot water or milk can be prepared, the machine has to heat up.

Example: Proceed as follows to change the energy-saving mode from **SAVE LEVEL 1** to **SAVE LEVEL 2**.

Precondition: **COFFEE READY** is displayed.

- ▶ Open the cover of the Rotary Switch.
- 🔌 ▶ Keep the Rotary Switch pressed **until** **MAINTENANCE** appears.
- 🔄 ▶ Turn the Rotary Switch until **ECONOMY MODE 1** is displayed.
- 🔌 ▶ Press the Rotary Switch to enter the programme item.
SAVE LEVEL 1
- 🔄 ▶ Turn the Rotary Switch until **SAVE LEVEL 2** is displayed.
- 🔌 ▶ Press the Rotary Switch to confirm the setting.
CONFIRMED ✓ appears briefly on the display.
ECONOMY MODE 2
- 🔄 ▶ Turn the Rotary Switch until **EXIT** is displayed.
- 🔌 ▶ Press the Rotary Switch to exit programming mode.
COFFEE READY







Automatic switch-off

By instructing your IMPRESSA to automatically switch itself off, you can cut down your energy consumption. If this function is activated, your IMPRESSA switches off automatically after the last action on the machine.

- i** The programmable switch-off time can be adjusted between 0.5 and 15 hours.

Example: Proceed as follows to change the automatic switch-off time from **2 H** to **1 H**.

Precondition: **COFFEE READY** is displayed.

- ▶ Open the cover of the Rotary Switch.
-  ▶ Keep the Rotary Switch pressed **until** **MAINTENANCE** appears.
-  ▶ Turn the Rotary Switch until **OFF AFTER 2 H** is displayed.
-  ▶ Press the Rotary Switch to enter the programme item.
OFF AFTER 2 H
-  ▶ Turn the Rotary Switch until **OFF AFTER 1 H** is displayed.
-  ▶ Press the Rotary Switch to confirm the setting.
CONFIRMED ✓ appears briefly on the display.
OFF AFTER 1 H
-  ▶ Turn the Rotary Switch until **EXIT** is displayed.
-  ▶ Press the Rotary Switch to exit programming mode.
COFFEE READY



Rinses

You can set whether the switch-on rinse should be started manually or automatically.

You can set whether cappuccino rinsing should be prompted immediately or 10 minutes after a milk product has been prepared.

Example: Proceed as follows to programme that Cappuccino rinsing should be prompted **immediately** after a milk product has been prepared.

Precondition: **COFFEE READY** is displayed.

- ▶ Open the cover of the Rotary Switch.
-  ▶ Keep the Rotary Switch pressed **until** **MAINTENANCE** appears.
-  ▶ Turn the Rotary Switch until **RINSES** is displayed.
-  ▶ Press the Rotary Switch to enter the programme item.
INIT RINSE MANUAL

4 Permanent settings in programming mode

- ⌚ ▶ Turn the Rotary Switch until **CAPP RINSE AFTER 10'** is displayed.
- ⌚ ▶ Press the Rotary Switch to enter the programme item.
CAPP RINSE AFTER 10'
- ⌚ ▶ Turn the Rotary Switch until **CAPP RINSE NOW** is displayed.
- ⌚ ▶ Press the Rotary Switch to confirm the setting.
CONFIRMED ✓ appears briefly on the display.
CAPP RINSE NOW
- ⌚ ▶ Turn the Rotary Switch until **EXIT** is displayed.
- ⌚ ▶ Press the Rotary Switch to exit the programme item.
RINSES
- ⌚ ▶ Turn the Rotary Switch until **EXIT** is displayed.
- ⌚ ▶ Press the Rotary Switch to exit programming mode.
COFFEE READY

Restore factory settings

In the programme item **RESET** you can reset various settings to their factory settings:

- **PRODUCT**
 - The settings (amount of water, aroma, temperature etc.) for any product can be reset individually to the factory settings. The corresponding double product is reset to the factory settings at the same time.
- **ALL PROD.**
 - The settings (amount of water, aroma, temperature etc.) for all products are reset to the factory settings.
- **ALL**
 - All customer settings are reset to the factory settings. Your IMPRESSA then switches off.
- **EMPT.SYST.**
 - The system will be emptied. Your IMPRESSA then switches off.

Example: Proceed as follows to reset the values for 'Espresso' to the factory settings.

Precondition: **COFFEE READY** is displayed.

- ⌚ ▶ Keep the Rotary Switch pressed **until** **MAINTENANCE** appears.
- ⌚ ▶ Turn the Rotary Switch until **RESET** is displayed.

- ⌚ ▶ Press the Rotary Switch to enter the programme item.
`RESET / PRODUCT`
- ⌚ ▶ Press the Rotary Switch to enter the programme item.
`SELECT PRODUCT`
- ☑ ▶ Press the Espresso button.
`CONFIRMED ✓` appears briefly on the display. The settings for 'Espresso' are reset to the factory settings.
`RESET / PRODUCT`
- ⌚ ▶ Turn the Rotary Switch until `RESET / EXIT` is displayed.
- ⌚ ▶ Press the Rotary Switch to exit the programme item.
`RESET`
- ⌚ ▶ Turn the Rotary Switch until `EXIT` is displayed.
- ⌚ ▶ Press the Rotary Switch to exit programming mode.
`COFFEE READY`

Lock

Settings in `LOCK` programme item:







- `PRODUCT`
 - Each product can be locked individually, preparation is not possible. If the button is subsequently pressed, `LOCKED` appears briefly in the display.
- `PRE-SELECT`
 - The pre-selection of coffee strength for coffee à la carte is locked.
- `MAINT.`
 - All maintenance programmes are locked and cannot be started. The `MAINTENANCE` programme item is locked.

Example: How to lock the 2 Espresso button.

Precondition: `COFFEE READY` is displayed.

- ⌚ ▶ Press and hold the Rotary Switch until `MAINTENANCE` appears.
- ⌚ ▶ Turn the Rotary Switch until `LOCK` is displayed.
- ⌚ ▶ Press the Rotary Switch to enter the programme item.
`LOCK / PRODUCT`
- i** Turn the Rotary Switch to select the `PRE-SELECT` and `MAINT.` programme items.
- ⌚ ▶ Press the Rotary Switch.
`SELECT PRODUCT`

4 Permanent settings in programming mode







-  ▶ Press the 2 Espresso button.
LOCKED appears briefly on the display.
LOCK / PRODUCT
-  To unlock, press the Rotary Switch and then the corresponding product button. **FREE** appears briefly on the display.
-  ▶ Turn the Rotary Switch until **LOCK / EXIT** is displayed.
-  ▶ Press the Rotary Switch to exit the programme item.
LOCK
-  ▶ Turn the Rotary Switch until **EXIT** is displayed.
-  ▶ Press the Rotary Switch to exit programming mode.
COFFEE READY

Unit amount of water

You can change the unit of the amount of water from 'ml' to 'oz'.

Example: To change the unit for the amount of water from **ML** to **OZ**, proceed as follows.

Precondition: **COFFEE READY** is displayed.

- ▶ Open the cover of the Rotary Switch.
-  ▶ Keep the Rotary Switch pressed until **MAINTENANCE** appears.
-  ▶ Turn the Rotary Switch until **SETTINGS ML** is displayed.
-  ▶ Press the Rotary Switch to enter the programme item.
SETTINGS ML
-  ▶ Turn the Rotary Switch until **SETTINGS OZ** is displayed.
-  ▶ Press the Rotary Switch to confirm the setting.
CONFIRMED ✓ appears briefly on the display.
SETTINGS OZ
-  ▶ Turn the Rotary Switch until **EXIT** is displayed.
-  ▶ Press the Rotary Switch to exit programming mode.
COFFEE READY

Language

You set the language when you used the machine for the first time.

Example: To change the language from **ENGLISH** to **DEUTSCH** (example), proceed as follows.

Precondition: **COFFEE READY** is displayed.

-  ▶ Keep the Rotary Switch pressed until **MAINTENANCE** appears.

4 Permanent settings in programming mode

- ⌚ ▶ Turn the Rotary Switch until `LANGUAGE ENGLISH` is displayed.
- ⌚ ▶ Press the Rotary Switch to enter the programme item.
`LANGUAGE ENGLISH`
- ⌚ ▶ Turn the Rotary Switch until `SPRACHE DEUTSCH` (example) is displayed.
- ⌚ ▶ Press the Rotary Switch to confirm the setting.
`GESPEICHERT ✓` (example) appears briefly on the display.
`SPRACHE DEUTSCH` (example)
- ⌚ ▶ Turn the Rotary Switch until `EXIT` is displayed.
- ⌚ ▶ Press the Rotary Switch to exit programming mode.
`BITTE WAHLEN` (example)

5 Maintenance

Your IMPRESSA has the following integrated maintenance programmes:

- Clean cappuccino frother
 - Rinse machine
 - Rinse cappuccino frother
 - Clean machine
 - Decalcify machine
 - Change filter
- i** Clean or descale the machine or change the filter whenever the appropriate prompt is displayed.

Maintenance tips

To ensure that you get many years of reliable service out of your IMPRESSA and to guarantee the optimum coffee quality, the machine requires daily maintenance.

You should proceed as follows:

- Empty the coffee grounds container and the drip tray. Rinse them with warm water.
- Rinse the water tank with clean water.
- Dismantle and rinse the frother (see Chapter 5 'Maintenance – Rinsing the cappuccino frother').
- Wipe the surface of the machine with a damp cloth.

Cleaning the cappuccino frother

i This chapter applies to the **Professional and Easy Cappuccino Frothers**.

To ensure that the respective frother works perfectly, you should clean it **daily** when you have been preparing milk.

CAUTION

If the wrong cleaning agent is used, the machine could be damaged and/or traces of detergent could be left behind in the water.

- ▶ Use only original JURA care products.

i The IMPRESSA will not prompt you to clean the frother.
i The JURA Cappuccino Cleaner is available from stockists.

@ You can also try out the 'Cleaning the cappuccino frother' operation online. Visit the Knowledge Builder at www.jura.com.

Precondition: **COFFEE READY** is displayed.

- ▶ Open the cover of the Rotary Switch.
- ⏻ ▶ Keep the Rotary Switch pressed until **MAINTENANCE** appears.
- ⏻ ▶ Press the Rotary Switch to enter the programme item.
CLEAN CAPPUCCINO
- ⏻ ▶ Press the Rotary Switch.
CLEANER FOR CAPPU., the maintenance button **⚡** lights up.
- ▶ Pour 250 ml of fresh water into a container and add one capful (max. 15 ml) of Cappuccino Cleaner.
- ▶ Immerse the milk pipe in the receptacle with the cleaning solution.

i If you are using the **Professional Cappuccino Frother**, turn the selection lever to the milk foam **☕** or milk **☕** position.



- ▶ Place another receptacle under the frother.
- ⚡ ▶ Press the maintenance button.
CAPPUCCINO / CLEANS, the frother and pipe are cleaned.
WATER FOR CAPPUCCINO, the maintenance button **⚡** lights up.



- ▶ Rinse the receptacle thoroughly, fill it with approx. 250 ml of fresh water and immerse the milk pipe in the water.
- ▶ Empty the other receptacle and place it under the frother once more.
- ⚡ ▶ Press the maintenance button.
CAPPUCCINO / CLEANS, the frother and pipe are rinsed with fresh water.
COFFEE READY appears on the display. Your IMPRESSA is once more ready to use.

Rinsing the machine

When the IMPRESSA is switched on, a prompt to perform a rinse operation appears after heating, or this is automatically started.

It can be set in programming mode whether the switch-on rinse needs to be activated manually or whether the machine automatically activates the switch-on rinse (see Chapter 4 'Permanent settings in programming mode – Rinses').

When the IMPRESSA is switched off, a rinse operation is automatically initiated.

You can initiate the rinse operation manually at any time.



Precondition: **COFFEE READY** is displayed.

- ▶ Place a receptacle under the coffee spout.
- ▶ Open the cover of the Rotary Switch.
- ⌚ ▶ Keep the Rotary Switch pressed until **MAINTENANCE** appears.
- ⌚ ▶ Press the Rotary Switch to enter the programme item. **CLEAN CAPPUCCINO**
- ⌚ ▶ Turn the Rotary Switch until **RINSE MACHINE** is displayed.
- ⌚ ▶ Press the Rotary Switch to initiate the rinse operation. **MACHINE RINSING**
Rinsing stops automatically and your IMPRESSA is then once more ready for use.

Rinsing the cappuccino frother

i This chapter applies to the **Professional and Easy Cappuccino Frothers**.

Each time milk has been prepared the IMPRESSA displays a prompt for Cappuccino rinsing.

It can be set in programming mode whether the rinsing prompt is displayed **immediately** or **10 minutes** after preparation (refer to Chapter 4 'Permanent settings in programming mode – Rinses').

Rinsing following a prompt



Precondition: **COFFEE READY / RINSE CAPPUCCINO** is displayed and the maintenance button **⚙** lights up.





- ▶ Place a receptacle under the frother.
- i** If you are using the **Professional Cappuccino Frother**, turn the selection lever to the steam position **☑**.
- ⚙** ▶ Press the maintenance button. **CAPPU. RINSING**, the frother is rinsed.
The procedure stops automatically. **COFFEE READY** appears on the display.

Starting rinsing manually



You can initiate the 'Rinsing the cappuccino frother' operation manually.

Precondition: **COFFEE READY** is displayed.

- ▶ Place a receptacle under the frother.
- i** If you are using the **Professional Cappuccino Frother**, turn the selection lever to the steam position .
- ▶ Open the cover of the Rotary Switch.
-  ▶ Keep the Rotary Switch pressed **until MAINTENANCE** appears.
-  ▶ Press the Rotary Switch to enter the programme item. **CLEAN CAPPUCCINO**
-  ▶ Turn the Rotary Switch until **RINSE CAPPUCCINO** is displayed.
-  ▶ Press the Rotary Switch to start the rinse operation. **CAPPU. RINSING**, the frother is rinsed.
The procedure stops automatically. **COFFEE READY** appears on the display.

Disassembling and rinsing the Professional Cappuccino Frother

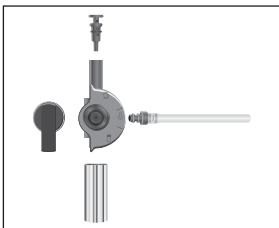

- ▶ Carefully remove the frother from the Connector System[®] by twisting slightly.
- ▶ Dismantle the frother completely.
- ▶ Rinse all the frother parts thoroughly under running water.
- ▶ Reassemble the frother.
- i** Ensure that the individual parts are correctly and firmly attached to one another to ensure optimum function of the frother.
- ▶ Firmly attach the frother to the Connector System[®].

Disassembling and rinsing the Easy Cappuccino Frother

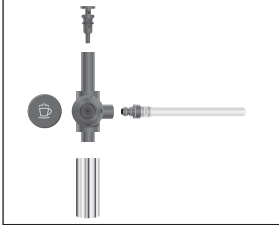

- ▶ Carefully remove the frother from the Connector System® by twisting slightly.
- ▶ Dismantle the frother completely.
- ▶ Rinse all the frother parts thoroughly under running water.
- ▶ Reassemble the frother.

i Ensure that the individual parts are correctly and firmly attached to one another to ensure optimum function of the frother.

- ▶ Firmly attach the frother to the Connector System®.

Cleaning the machine

After 220 coffee preparations or 80 switch-on rinses, the IMPRESSA will prompt you to clean it.

CAUTION

If the wrong cleaning agent is used, the machine could be damaged and/or traces of detergent could be left behind in the water.

- ▶ Use only original JURA care products.

i The cleaning programme only lasts about 20 minutes.

i Do not interrupt the cleaning programme. The quality of cleaning will be impaired if you do so.

i JURA cleaning tablets are available from stockists.

@ You can also try out the 'Cleaning the machine' operation online. Visit the Knowledge Builder at www.jura.com.

Cleaning following a prompt

Precondition: COFFEE READY / CLEAN MACHINE is displayed, and the maintenance button ☸ lights up.

- ☸ ▶ Press the maintenance button.

DURATION 20 MIN. / START YES

i If you want to clean the machine at a later point in time, turn the Rotary Switch until START NO is displayed. Exit the maintenance programme by pressing the Rotary Switch. The prompt 'Clean machine' remains on the display.

- ☸ ▶ Press the maintenance button.

EMPTY TRAY

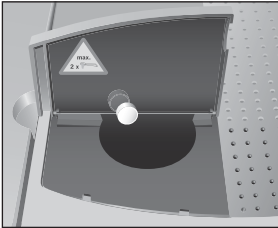

- ▶ Empty the drip tray and coffee grounds container and put them back into the machine.
- ▶ **PRESS RINSE**, the maintenance button ☸ lights up.
- ▶ Place a receptacle under the coffee spout and the frother.
- ☸ ▶ Press the maintenance button.
- ▶ **CLEANS**, the cleaning operation starts.
- ▶ The process is interrupted. **ADD TABLET / PRESS RINSE**, the maintenance button ☸ lights up.
- ▶ Open the cover of the filler funnel for pre-ground coffee.

- ▶ Insert a JURA cleaning tablet into the filler funnel.
- ▶ Close the cover of the filler funnel.
- ☸ ▶ Press the maintenance button.
- ▶ **CLEANS**, water flows out of the coffee spout and the frother several times.

i You can follow the current status of cleaning on the progress bar.

The process is interrupted, **EMPTY TRAY**.

- ▶ Empty the drip tray and coffee grounds container and put them back into the machine.
- ▶ The cleaning operation is now complete. The IMPRESSA is ready for use again.

Manual cleaning

You can initiate the 'Cleaning the machine' operation manually.

Precondition: **COFFEE READY** is displayed.

- ▶ Open the cover of the Rotary Switch.
- ⌚ ▶ Keep the Rotary Switch pressed **until MAINTENANCE** appears.
- ⌚ ▶ Press the Rotary Switch to enter the programme item.
- ▶ **CLEAN CAFFUCCINO**
- ⌚ ▶ Turn the rotary switch until **CLEAN MACHINE** is displayed.
- ⌚ ▶ Press the Rotary Switch.
- ▶ **DURATION 20 MIN. / START YES**
- ▶ Continue with the **second** prompt to take action (indicated by a ▶), as is described under 'Cleaning following a prompt'.

Descaling the machine

The IMPRESSA builds up deposits of limescale over time and automatically prompts you to descale it when necessary. The degree of calcification depends on the degree of hardness of your water.



CAUTION

If the descaling agent comes into contact with the skin or eyes, this can cause irritation.

- ▶ Avoid contact with the skin or eyes.
- ▶ Rinse the descaling agent off with clean water. Should you get any descaling agent in your eye, see a doctor.

CAUTION

If the wrong descaling agent is used, the machine could be damaged and/or traces of detergent could be left behind in the water.

- ▶ Use only original JURA care products.

CAUTION

If the descaling operation is interrupted, there may be damage to the machine.

- ▶ Allow the descaling program to run to the end.

CAUTION

If the descaling agent comes into contact with sensitive surfaces, damage cannot be ruled out.

- ▶ Clean up any splashes immediately.

-
- i** The descaling programme lasts approx. 45 minutes.
 - i** JURA descaling tablets are available from stockists.
 - i** If you use a CLARIS filter cartridge and this is activated, you will not be prompted to change the filter.

@ You can also try out the 'Descaling the machine' operation online. Visit the Knowledge Builder at www.jura.com.

Descaling following a prompt

Precondition: COFFEE READY / DECALCIFY MACHINE is displayed and the maintenance button ☼ lights up.

- ☼ ▶ Press the maintenance button.
DURATION 45 MIN. / START YES

- i** If you want to descale the machine at a later point in time, turn the Rotary Switch until START NO is displayed. Exit the maintenance programme by pressing the Rotary Switch. The prompt 'Decalcify machine' remains on the display.

- ☼ ▶ Press the maintenance button.
EMPTY TRAY

- ▶ Empty the drip tray and coffee grounds container and put them back into the machine.

SOLVENT IN TANK

- ▶ Remove the water tank and empty it.
- ▶ Completely dissolve the contents of one blister (3 JURA descaling tablets) in a container that holds 600 ml of water. This may take several minutes.
- ▶ Pour the solution into the empty water tank and insert it in the machine.

SOLVENT IN TANK / PRESS RINSE, the maintenance button  lights up.

- ▶ Remove the frother from the Connector System[®].
- ▶ Place a receptacle under the hot water spout and another under the Connector System[®].

-  ▶ Press the maintenance button.

DESCALCS, water flows out of the Connector System[®] and the hot water spout. The maintenance button  flashes during the descaling operation.

- i** You can follow the current status of descaling on the progress bar.

The process is interrupted, **EMPTY TRAY**.

- ▶ Empty the receptacles below the hot water spout and the Connector System[®].
- ▶ Empty the drip tray and coffee grounds container and put them back into the machine.

RINSE WATER TANK / FILL WATER TANK

- ▶ Remove the water tank and rinse it thoroughly.
- ▶ Fill the water tank with fresh, cold water and reinsert.
- ▶ **PRESS RINSE**, the maintenance button  lights up.
- ▶ Refit the frother.

- ▶ Place a receptacle under the coffee and hot water spout and another under the frother.

-  ▶ Press the maintenance button.

DESCALCS, water flows out of the frother and the hot water spout.

The process is interrupted, **HEATING UP**.

MACHINE RINSING, water flows out of the coffee spout. The operation stops automatically, **EMPTY TRAY**.

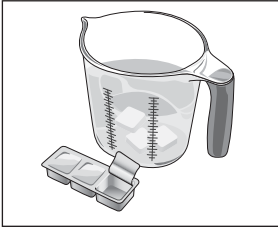





- ▶ Empty the drip tray and coffee grounds container and put them back into the machine.
The descaling operation is now complete. Your IMPRESSA heats up and is once again ready to use.

i If the descaling operation stops unexpectedly, rinse the water tank thoroughly.

Manual descaling

You can initiate the 'Descaling the machine' operation manually.

Precondition: **COFFEE READY** is shown on the display and the filter is not activated.

- ▶ Open the cover of the Rotary Switch.
-  ▶ Keep the Rotary Switch pressed until **MAINTENANCE** appears.
-  ▶ Press the Rotary Switch to enter the programme item.
CLEAN CAPPUCCINO
-  ▶ Turn the Rotary Switch until **DESCALIFY MACHINE** is displayed.
-  ▶ Press the Rotary Switch.
DURATION 45 MIN. / START YES
- ▶ Continue with the **second** prompt to take action (indicated by a ▶), as is described under '**Descaling following a prompt**'.

Changing the filter

- i** After 50 litres of water have flowed through, the filter will cease to work. Your IMPRESSA will automatically prompt you to replace the filter.
- i** After two months, the filter will cease to work. Monitor the elapsed time by adjusting the date plate on the cartridge holder.
- i** If the CLARIS filter cartridge is not activated, you will not be prompted to change the filter.
- @ You can also try out 'Changing the filter' online. Visit the Knowledge Builder at www.jura.com.

Change following a prompt

To change the CLARIS filter cartridge when prompted to do so by your IMPRESSA, proceed as follows:

Precondition: COFFEE READY / CHANGE FILTER is displayed, and the maintenance button ☸ lights up.

- ☸ ▶ Press the maintenance button.

DURATION 2 MIN. / START YES

- i** If you want to change the filter at a later point in time, turn the Rotary Switch until START NO is displayed. Exit the maintenance programme by pressing the Rotary Switch. The prompt 'Change filter' remains on the display.

- ☸ ▶ Press the maintenance button.

CHANGE FILTER / PRESS RINSE

- ▶ Remove the water tank and empty it.
- ▶ Lift the cartridge holder.
- ▶ Take out the old CLARIS filter cartridge and the extension.
- ▶ Fit the extension on top of a new filter cartridge.
- ▶ Insert the filter cartridge into the water tank, exerting slight pressure.
- ▶ Close the cartridge holder. It will click into place audibly.
- ▶ Fill the water tank with fresh, cold water and reinsert.



- ▶ Place a receptacle (at least 500 ml) under the frother.

- i** If you are using the **Professional Cappuccino Frother**, set the selection lever of the frother to the steam position ☸.

- ☸ ▶ Press the maintenance button.

FILTER RINSING, water flows out of the frother.

- i** You can interrupt filter rinsing at any time. To do this, press any button.

- i** The water may be slightly discoloured. This is not harmful to health and does not affect the taste.

Filter rinsing stops automatically after approx. 500 ml. The IMPRESSA heats up and is once again ready to use.

Manual filter change

You can initiate the 'Changing the filter' operation manually.

Precondition: The filter is activated and **COFFEE READY** is shown on the display.

- ▶ Open the cover of the Rotary Switch.
- ⏻ ▶ Keep the Rotary Switch pressed until **MAINTENANCE** appears.
- ⏻ ▶ Press the Rotary Switch to enter the programme item.
CLEAN CAPPUCCINO
- ⌚ ▶ Turn the Rotary Switch until **CHANGE FILTER** is displayed.
- ⏻ ▶ Press the Rotary Switch.
DURATION 2 MIN. / START YES
- ▶ Continue with the **second** prompt to take action (indicated by a ▶), as is described under '**Replacement following a prompt**'.

Cleaning the bean container

Coffee beans may be covered with a slight oil film which remains on the walls of the bean container. These residues may negatively affect the coffee results. For this reason clean the bean container from time to time.



Danger of injury to the fingers when the grinder is running.

- ▶ Switch the machine off with the on/off button ⏻ before performing any work on the grinder.
 - ▶ Switch the machine off at the power switch ⏻.
-

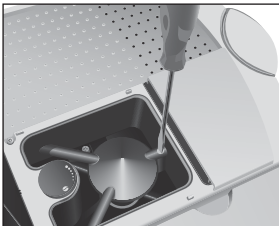

- ▶ Open the cover of the bean container and remove the aroma preservation cover.
- ▶ Remove the beans with a vacuum cleaner.
- ▶ Loosen the screw in the bean container and lift up the finger protection.
- ▶ Remove the remaining beans with a vacuum cleaner.
- ▶ Clean the bean container with a soft, dry cloth.
- ▶ Put the finger protection down again and screw it back tightly in place.
- ▶ Fill the bean container with coffee beans, then close the aroma preservation cover and the bean container cover.

Descaling the water tank

Limescale deposits may form in the water tank. To ensure correct function of your IMPRESSA, you should descale the water tank from time to time.

- ▶ Remove the water tank.
- ▶ If you use a CLARIS filter cartridge, remove this.
- ▶ Descale the tank with a mild, commercially available descaling agent in accordance with the instructions of the manufacturer.
- ▶ Rinse the water tank with clean water afterwards.
- ▶ If you use a CLARIS filter cartridge, insert this again.
- ▶ Fill the water tank with fresh, cold water and reinsert.

6 Display messages

Message	Cause/Result	Action
FILL WATER TANK	The water tank is empty. You cannot prepare any coffee products, hot water or milk products.	▶ Fill the water tank (see Chapter 1, 'Preparing and using for the first time – Filling the water tank').
EMPTY GROUNDS	The coffee grounds container is full. You cannot prepare any coffee products, but you can prepare hot water or milk.	▶ Empty the coffee grounds container and the drip tray.
EMPTY TRAY	The drip tray is full. You cannot prepare any coffee products, hot water or milk products.	▶ Empty the drip tray.
TRAY MISSING	The drip tray is not inserted correctly or is not inserted at all. You cannot prepare any coffee products, hot water or milk products.	▶ Insert the drip tray. ▶ Clean the metal contacts on the back of the drip tray.
FILL BEANS	The bean container is empty. You cannot prepare any coffee products, but you can prepare hot water or milk.	▶ Fill the bean container (see Chapter 1, 'Preparing and using for the first time – Filling the bean container').
PRESS RINSE	The IMPRESSA is prompting you to start a rinse operation or continue a started maintenance programme.	▶ Press the maintenance button to start rinsing or to continue the maintenance programme.
COFFEE READY / RINSE CAPPUCCINO	The IMPRESSA is prompting you to start cappuccino rinsing.	▶ Press the maintenance button to start cappuccino rinsing.
COFFEE READY / CLEAN MACHINE	After 220 preparations or 80 switch-on rinses, the IMPRESSA will prompt you to clean it.	▶ Clean the machine (see Chapter 5, 'Maintenance – Cleaning the machine').

Message	Cause/Result	Action
COFFEE READY / CLEAN NOW	After 250 preparations the IMPRESSA will prompt you to clean it.	► Clean the machine (see Chapter 5, 'Maintenance – Cleaning the machine').
COFFEE READY / DECALCIFY MACHINE	The IMPRESSA is prompting you to descale it.	► Descale the machine (see Chapter 5, 'Maintenance – Descaling the machine').
COFFEE READY / DECALCIFY NOW	The IMPRESSA is prompting you to descale it.	► Descale the machine (see Chapter 5, 'Maintenance – Descaling the machine').
COFFEE READY / CHANGE FILTER	After 50 litres of water have flowed through, or after two months, the filter will cease to work.	► Replace the CLARIS filter cartridge (see Chapter 5 'Maintenance – Changing the filter').
COFFEE READY / CHANGE NOW	After 55 litres of water have flowed through, the filter will cease to work.	► Replace the CLARIS filter cartridge (see Chapter 5 'Maintenance – Changing the filter').
NOT ENOUGH PRE-GROUND	There is too little pre-ground coffee in the filler funnel. The IMPRESSA stops the operation.	► The next time you make coffee use more pre-ground coffee (refer to Chapter 3, 'Preparation at the touch of a button – Pre-ground coffee').

7 Troubleshooting

Problem	Cause/Result	Action
Grinder is making a very loud noise.	There are foreign objects in the grinder.	▶ Contact Customer Support in your country (see 'JURA contact details / Legal information').
The frother does not produce enough milk foam or milk sprays from the cappuccino frother.	The cappuccino frother is dirty or incorrectly attached.	<ul style="list-style-type: none"> ▶ Rinse and clean the cappuccino frother (see Chapter 5, 'Maintenance – Cappuccino frother'). ▶ Assemble the cappuccino frother correctly and firmly attach the frother to the Connector System® (refer to Chapter 5 'Maintenance – Disassembling and rinsing the frother').
Coffee only comes out in drips when it is being prepared.	Coffee or pre-ground coffee has been ground too finely and is blocking the system.	▶ Put the grinder on a coarser setting or use coarser pre-ground coffee (refer to Chapter 1, 'Preparing and using for the first time – Adjusting grinder').
Water hardness cannot be adjusted.	The CLARIS filter cartridge is activated.	▶ Deactivate the CLARIS filter cartridge in programming mode.
COFFEE READY / FILL BEANS is displayed although the bean container has been filled.	The grinder is not yet completely filled with beans.	▶ Prepare a coffee speciality.
COFFEE READY / FILL BEANS is not displayed although the bean container is empty.	The bean monitor is dirty.	▶ Clean the bean container (see Chapter 5, 'Maintenance – Cleaning the bean container').
EMPTY TRAY is always displayed.	The metal contacts of the drip tray are dirty or wet.	▶ Clean and dry the metal contacts on the back of the drip tray.
FILL WATER TANK is displayed although the water tank is full.	The water tank float is trapped.	▶ Descale the water tank (see Chapter 5, 'Maintenance – Descaling the water tank').

Problem	Cause/Result	Action
ERROR 2 is displayed.	If the machine was exposed to the cold for a long period of time, it is disabled from heating up due to safety reasons.	▶ Warm up the machine at room temperature.
Other ERROR messages are displayed.	–	▶ Turn the IMPRESSA off at the power switch. Contact Customer Support in your country (see 'JURA contact details / Legal information').

- i** If you have not been able to solve the problem, contact Customer Support in your country (see 'JURA contact details / Legal information').

8 Transport and environmentally neutral disposal

Transport / Emptying the system

Keep the packaging for your IMPRESSA. It should be used to protect the machine during transportation.

In order to protect the IMPRESSA from frost during transportation, the system must be emptied.

Precondition: **COFFEE READY** is displayed.

- ▶ Keep the Rotary Switch pressed until **MAINTENANCE** appears.
- ▶ Turn the Rotary Switch until **RESET** is displayed.
- ▶ Press the Rotary Switch to enter the programme item. **RESET / PRODUCT**
- ▶ Turn the Rotary Switch until **RESET / EMPT. SYST.** is displayed.
- ▶ Press the Rotary Switch. **EMPTY WATER TANK**
 - ▶ Remove the water tank.
 - ▶ Press **PRESS RINSE**, the Maintenance button  lights up.
 - ▶ Place one receptacle under the hot-water spout and another under the cappuccino frother.
- ▶ Press the Maintenance button. **SYSTEM EMPTYING**, a small amount of water flows out of the hotwater spout and the cappuccino frother. The operation stops automatically and your IMPRESSA switches off.



- i** The next time you use the machine the system must be refilled (see Chapter 1, 'Preparing and using for the first time – First-time use').

Disposal



Please dispose of old machines in an environmentally neutral way.

Old machines contain valuable materials capable of being recycled which should be salvaged for recycling. Please therefore dispose of old machines via your regional collection system.

9 Technical data

Voltage	220–240 V ~, 50 Hz
Power	1450 W
Marks of conformity	CE 
Airborne noise emitted	$L_p < 70$ dB (A)
Energy SAVE NO	40 Wh
Energy SAVE LEVEL 1	20 Wh
Energy SAVE LEVEL 2	15 Wh
Pump pressure	Static max. 15 bar
Holding capacity of water tank	5.7 l
Holding capacity of bean container	280 g
Holding capacity of coffee grounds container	Approx. 40 servings
Cable length	Approx. 1.1 m
Weight	13.8 kg
Dimensions (W x H x D)	41 x 47 x 39 cm

Index

A

- Aroma preservation cover 4
- Automatic switch-off 31

B

- Bean container
 - Aroma preservation cover 4
 - Cleaning 46
 - Cover 4
 - Filling 10

C

- Cappuccino 24
- Cappuccino frother
 - Cleaning 36
 - Easy Cappuccino Frother 9
 - Professional Cappuccino Frother 9
 - Rinsing 38
- CLARIS filter cartridge
 - Changing 44
 - Using and activating 11
- Cleaning
 - Bean container 46
 - Cappuccino frother 36
 - Machine 40
- Coffee 23
- Coffee à la carte 24
- Coffee grounds container 4
- Coffee spout, height-adjustable 4
- Connector System® 4, 9
- Control options 16
- Cover
 - Bean container 4
 - Filler funnel for pre-ground coffee 4

D

- Descaling
 - Machine 42
 - Water tank 47
- Display messages 48
- Display, Messages 48
- Drip tray 4

E

- Easy Cappuccino Frother
 - Disassembling and rinsing 40
- Emptying the system 52

- Energy-saving mode 30
- Entering a default setting for the amount of water for a cup size 18

- Errors
 - Troubleshooting 50
- Espresso 23

F

- Factory settings
 - Restore factory settings 32
- Filler funnel for pre-ground coffee 4
- Filling
 - Bean container 10
 - Water tank 9
- Filter
 - Changing 44
 - Using and activating 11
- Fineness of grind
 - Adjusting grinder 13
 - Fineness of grind switch 4
- Fineness of grind switch 4
- First-time use 10
- Frother
 - Easy Cappuccino Frother 9
 - Professional Cappuccino Frother 9

H

- Hardness of water 12
- Hot milk 26
- Hot water 27
 - Hot water portion 27
- Hot water spout 4

I

- Internet 9

L

- Language 34
- Latte macchiato 24

M

- Machine
 - Cleaning 40
 - Descaling 42
 - Rinsing 37
 - Setting up 9
 - Switching off 15
 - Switching on 14
- Maintenance 36
 - Maintenance tips 36

- Milk
 - Hot 26
 - Milk portion 26
- Milk foam 26
- O**
 - One-off settings before and during preparation 17
- P**
 - Permanent settings in programming mode 28
 - Power switch 4
 - Pre-ground coffee 25
 - Filler funnel 4
 - Pre-ground coffee 25
 - Preparation
 - At the touch of a button 23
 - Cappuccino 24
 - Coffee 23
 - Coffee à la carte 24
 - Espresso 23
 - Hot water 27
 - Latte macchiato 24
 - Milk 26
 - Pre-ground coffee 25
 - Problems
 - Troubleshooting 50
 - Professional Cappuccino Frother 4, 9
 - Disassembling and rinsing 39
 - Programming mode 28
 - Automatic switch-off 31
 - Energy-saving mode 30
 - Language 34
 - Products 28
 - Rinses 31
 - Unit amount of water 34
- R**
 - Reset
 - Restore factory settings 32
 - Restore factory settings 32
 - Rinses 31
 - Rinsing
 - Cappuccino frother 38
 - Machine 37
 - Rotary switch 5
- S**
 - Safety 6
 - Selector switch 5
 - Settings
 - Entering a default setting for the amount of water for a cup size 18
 - One-off settings before and during preparation 17
 - Permanent settings in programming mode 28
 - Restore factory settings 32
 - Setting up 9
 - Switching off 15
 - Switching on 14
- T**
 - Technical data 53
 - Troubleshooting 50
- U**
 - Use
 - Proper 6
 - Use, First time 10
- V**
 - Viewing information and maintenance status 21
 - Viewing maintenance status 21
- W**
 - Water hardness 12
 - Determining and adjusting 12
 - Water tank 4
 - Descaling 47
 - Filling 9

JURA contact details / Legal information

Your JURA dealer:

JURA Elektroapparate AG
Kaffeeweltstrasse 10
CH-4626 Niederbuchsiten
Tel. +41 62 38 98 233
www.jura.com

Directives

The machine complies with the following directives:

- 2006/42/EC – Machinery Directive
- 2004/108/EC – Electromagnetic Compatibility
- 2009/125/EC – Ecodesign

Technical changes

We reserve the right to make technical changes. The illustrations used in the IMPRESSA Xs95/Xs90 One Touch Manual show the IMPRESSA Xs95 One Touch model. Your IMPRESSA could incorporate minor changes.

Feedback

Your opinion is important to us! Use the contact link at www.jura.com.

Copyright

The Instructions for Use contain information which is protected by copyright. It is not permitted to photocopy or translate these Instructions for Use into another language without the express written consent of JURA Elektroapparate AG.