

Jura GIGA X9

Operating & cleaning Instructions



My Coffee Shop Pty Ltd
ACN 102 850 037

390 Johnston St
Abbotsford VIC 3067
ph: 03 9946 4160

97/1-5 Harwood St
Pymont NSW 2009
ph: 02 9034 6580

Control elements

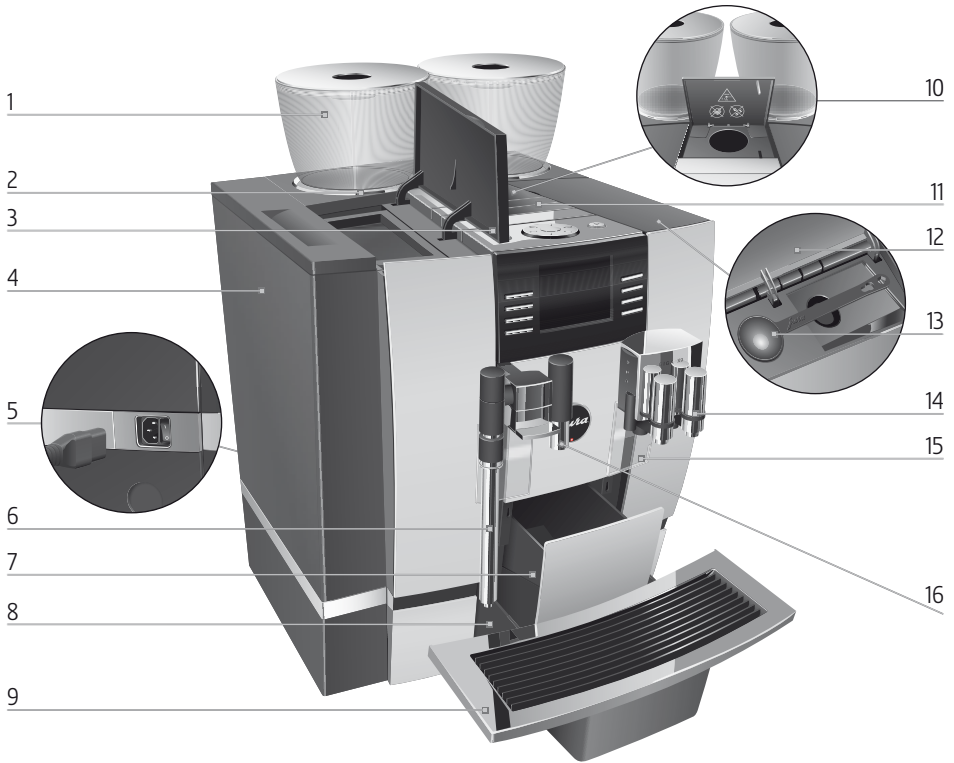



- 1 Bean container with aroma preservation cover
- 2 Bean container status indicator
- 3 Water tank cover
- 4 Water tank
- 5 Power switch and plug-in mains cable (back of the machine)
- 6 Professional steam lance (pivoting)
- 7 Coffee grounds container
- 8 Drip tray
- 9 Cup grille

- 10 Filler funnel for ground coffee
- 11 Ventilation slats (Venti Ports)
- 12 Storage compartment cover
- 13 Measuring spoon for ground coffee
- 14 Height- and width-adjustable dual spout
- 15 Splash guard
- 16 Height-adjustable hot-water spout



Top of the machine

- 1  On/Off button
- 2  Rotary Switch
- 3  P button (programming)

Front

- 4 Display
- 5 Multi-function buttons (button function depends on what is shown in the display)



Back of the machine

- 1 Service cover (open by pressing with your finger)
- 2 Locking device
- 3 Sliding catch
- 4 Service socket (underneath cover)

Cleaning Products – GIGA X9 (Tank water)

Daily

See procedure – Daily milk system clean

Must be performed at the end of each day just before the machine is turned off

Purpose: To ensure the milk systems are clean overnight so milk does not go off blocking the pathways



Automatic milk system

Use Cafetto daily milk cleaner 1 litre bottle (Prod no. 71144) OR Jura Milk System Cleaner Mini Tabs 180g (Prod no. 71150)



Steam wand

Use Cafetto Inverso milk cleaner 750 gm tub (Prod no. 71146)

Weekly

See procedure – Weekly milk system clean

Performed once per week

Purpose: To remove any build up of milk fats to ensure the milk frother works correctly



Use Cafetto weekly milk cleaner – 1 litre bottle (Prod no. 71145)

When prompted

Clean machine – See procedure (Coffee system clean)

Performed only when prompted (Every 220 coffees)

Purpose: Removes coffee oil from the brewing unit and coffee path to maintain the quality of the coffee



Use Jura cleaning tablets - 6 pk (Prod no. 71111)
- 25 pk (Prod no. 71112)

See procedures – Changing the filter or Descaling the machine

Perform a filter change or descale only when prompted.

Purpose: Protects against lime scale build up inside the machine maintaining water & steam paths



Prod no. 71134



Prod no. 71122



My Coffee Shop Pty Ltd
ACN 102 850 037

390 Johnston St
Abbotsford Vic 3067
ph: 03 9946 4160

97/1-5 Harwood St
Pymont NSW 2009
ph: 02 9034 6580

GIGA X9 Professional

Daily milk system clean

Prod no. 71144 OR
Prod no. 71150



These short instructions do not replace the 'GIGA X9 Professional Instructions for Use'. Make sure you read and observe the safety information and warnings first in order to avoid hazards.

Precondition: »Please select product:«



»Maintenance status (1/5)«



»Cleaning agent for milk system.«

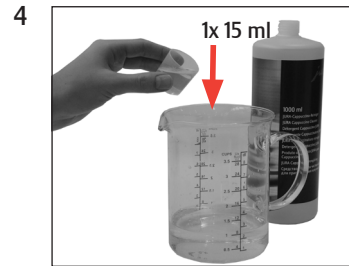

»Milk system is being rinsed.«
»Water for cleaning milk system.«

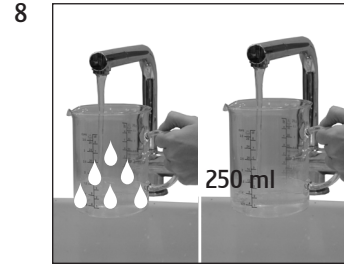

»Milk system is being rinsed.«
»Milk system cleaning complete.«
»Please select product:«

Daily cleaning procedure – Steam wand

The steam wand must be dismantled and cleaned daily to ensure it operates correctly

1. Remove the steam wand outer section – turn clockwise. (Fig 2)
2. Remove the steam wand inner section – turn clockwise. (Fig 3) If they are tight use the tool provided.
3. Soak steam wand in 500ml of hot water and ¼ scoop of Cafetto Inverso milk cleaner for 30min. (Fig 4)
4. Clean the temperature probe. (Fig 5)
5. Remove the steam wand from solution and rinse under tap water. (Fig 6)
6. Clean the steam wand inner & outer sections using the brushes provided. (Fig 7 & 8)
7. Re-assemble the steam wand (turn anti-clockwise), inner section followed by outer section. (Fig 9 & 10)

Please note: If the steam wand is not cleaned daily it will not operate correctly and can be damaged.



Figure 1



Figure 2



Figure 3

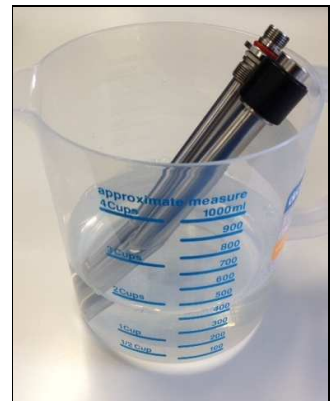

Figure 4



Figure 5



Figure 6



Figure 7

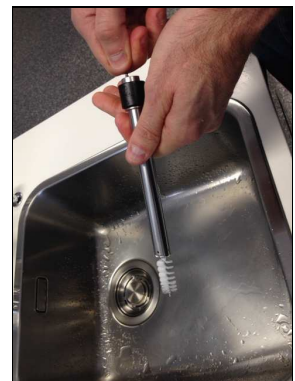

Figure 8



Figure 9



Figure 10

Weekly milk system clean

Complete this procedure once a week after the daily milk system clean

1. Remove the splash guard. (Fig 1)
2. Remove spout cover. Press the black releasing buttons and lift. (Fig 2 – 3)
3. Pull the milk outlet down (Fig 4) and the milk hose out. (Fig 5)
4. Remove the auto frother by pulling it towards you. (Fig 6)
5. Separate the auto frother into 6 parts. (Fig 7)
6. Soak all 6 parts in 250ml of warm water & 15ml of Cafetto red weekly solution (71145) for 20 min.
7. Remove the parts from solution and rinse under cold tap water.
8. Check that water flows through the milk outlet freely. (Fig 8)
9. Re-assemble the auto frother ensuring the arrow tips line up. (Fig 9)
10. Refit the auto frother, spout cover and splash guard.

Important:

The splash guard protects the coffee spout slide ribbon behind it from milk splatters and must be fitted. Be careful not to press on the coffee spout slide ribbon as it can be damaged.

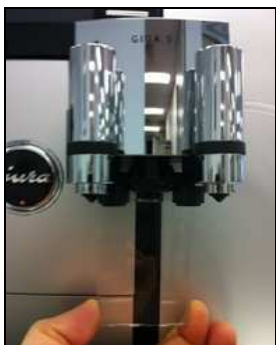

Figure 1



Figure 2



Figure 3



Figure 4



Figure 5



Figure 6



Figure 7



Figure 8



Figure 9



My Coffee Shop Pty Ltd
ACN 102 850 037

390 Johnston St
Abbotsford VIC 3067
ph: 03 9946 4160

97/1-5 Harwood St
Pymont NSW 2009
ph: 02 9034 6580

GIGA X9 Professional



Coffee system clean

Approximate duration 20 min.

3-phase-cleaning tablets
 Prod no. 71112 25pcs OR
 Prod no. 71111 6pcs



These short instructions do not replace the 'GIGA X9 Professional Instructions for Use'. Make sure you read and observe the safety information and warnings first in order to avoid hazards.

Precondition: »Clean machine.«
 (or: »Please select product:«)



»Maintenance status (1/5)«

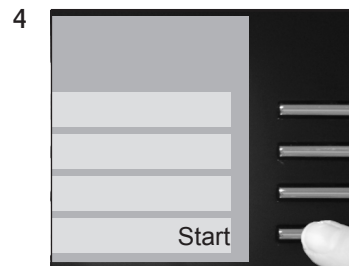

»Empty coffee grounds container.«

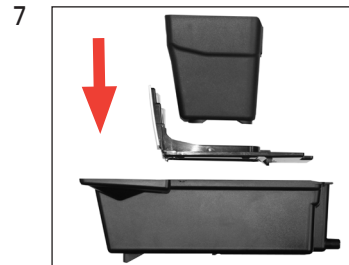
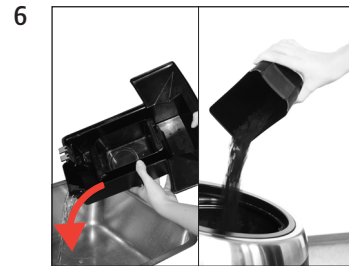
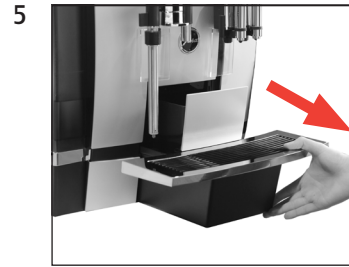

»Press the Rotary Switch.«



»Machine is being cleaned.«
 »Add cleaning tablet.«

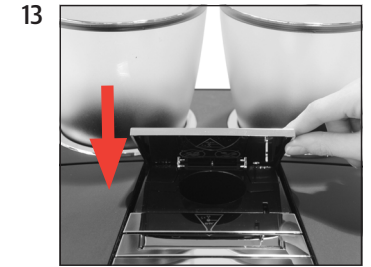
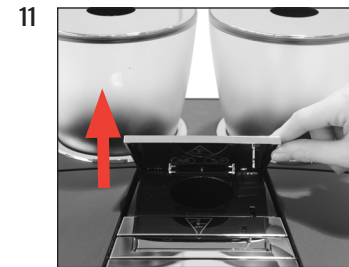

»Press the Rotary Switch.«



»Machine is being cleaned.«
 »Empty coffee grounds container.«

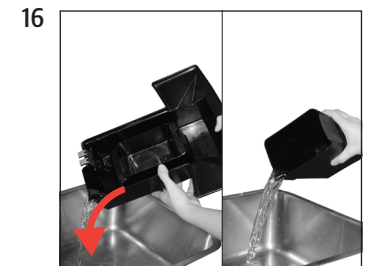
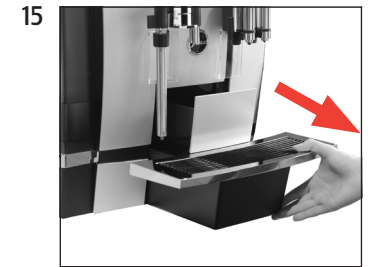

17

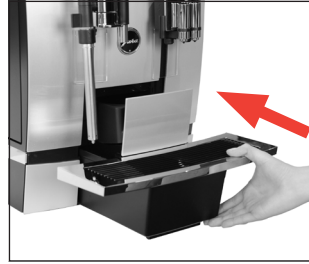

»Clean« / »Cleaning complete.«

»Please select product:«

GIGA X9 Professional



Changing the filter

CLARIS Pro Blue filter cartridge
Prod no. 71134



These short instructions do not replace the 'GIGA X9 Professional Instructions for Use'. Make sure you read and observe the safety information and warnings first in order to avoid hazards.

Precondition: »Change the filter«



»Maintenance status (1/5)«

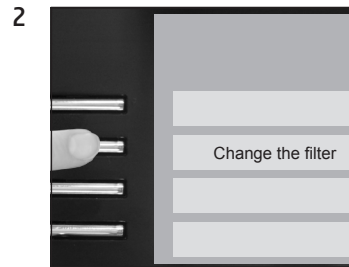

»Change filter.« / »Press the Rotary Switch.«

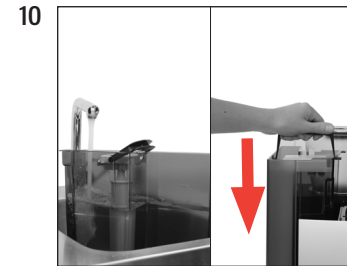
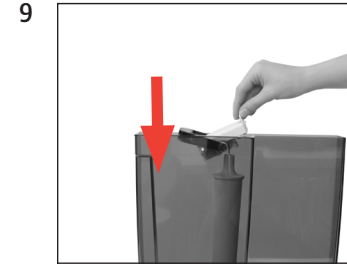
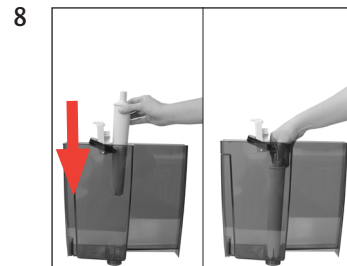
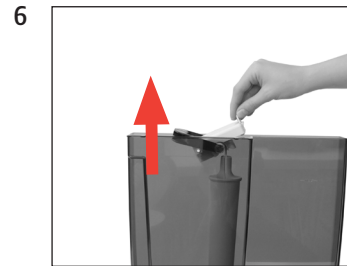
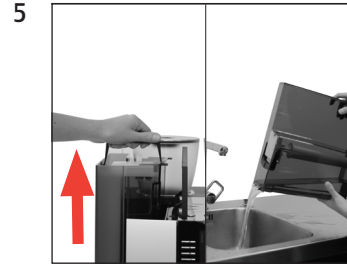

»Filter is being rinsed.«
»Empty drip tray.«

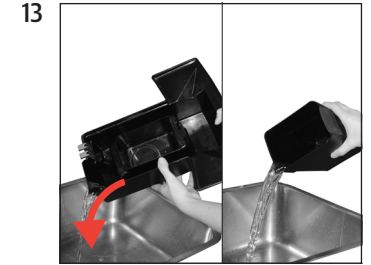

»Change the filter.« / »Filter rinsing complete.«

»Please select product:«

GIGA X9 Professional



Descaling the machine

Approximate duration 50 min.

Descaling tablets
Prod no. 71122



These short instructions do not replace the 'GIGA X9 Professional Instructions for Use'. Make sure you read and observe the safety information and warnings first in order to avoid hazards.

Precondition: »Decalcify machine.«
(or »Please select product:«)



»Maintenance status (1/5)«

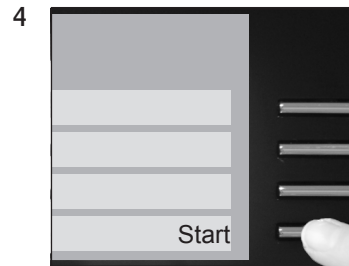
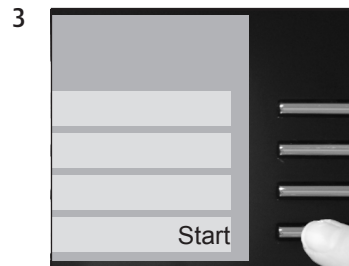
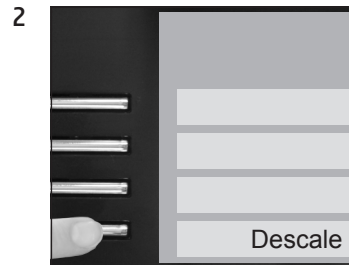

»Empty drip tray.«

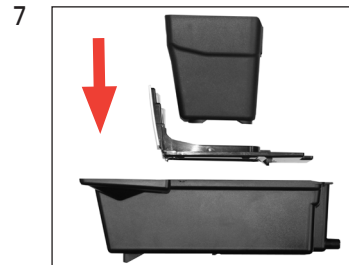

»Pour descaling agent into water tank.«

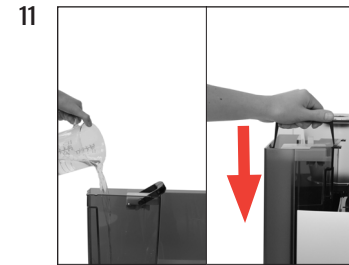
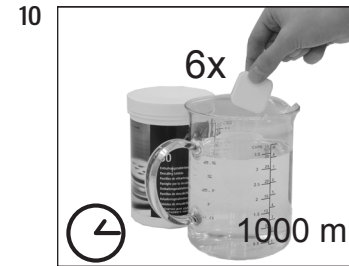
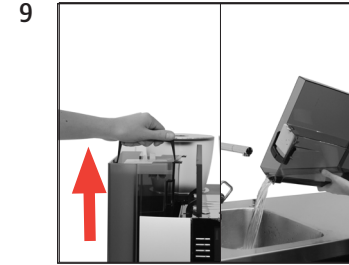

»Press the Rotary Switch.«



»Machine is being descaled.«
»Empty drip tray.«

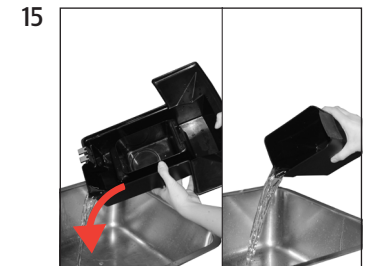
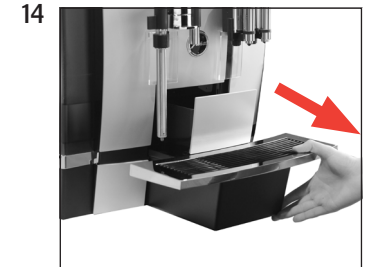

»Fill water tank.«

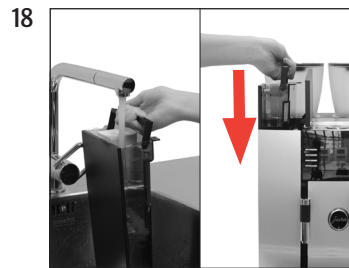
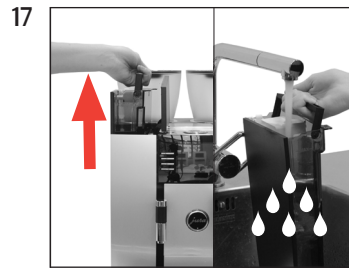

»Press the Rotary Switch.«



»Machine is being descaled.«
»Empty drip tray.«

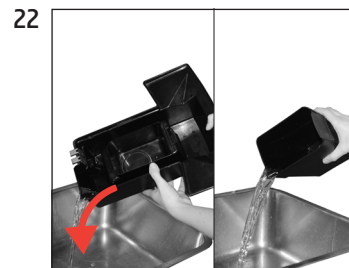
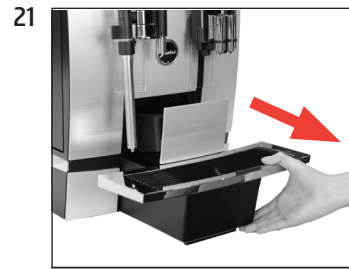

»Descal« / »Descaling complete.«

»Please select product:«

Troubleshooting:

Milk flow

- No milk Spluttering milk Not filling cups Froth milk is flat

Solution:

1. Remove the splash guard. (Fig 1)
2. Press the black releasing buttons on the sides of the spout cover and lift the cover off. (Fig 2 – 3)
3. If the flat milk is flowing normally and the problem is with the froth milk only, replace the air suction (Fig 4), refit the cover and test the milk again. If the problem has been solved, purchase spare air suction (Part no. 70008). If the problem has not been solved go to step 4.
4. Remove the auto frother by pulling the milk outlet down (Fig 5) and pulling the milk hose connector out (Fig 6). Now you will be able to remove the auto frother by pulling it towards you (Fig 7).
5. Separate the auto frother into 6 parts (Fig 8).
6. Soak 6 parts (Fig 8) in 250ml of warm water and 15 ml of Cafetto red weekly cleaning solution (71145) for 30 min.
7. Remove the parts from the solution and rinse under tap water.
8. Clean the milk, air and steam paths using the cleaning brushes. See 2 x milk path holes in Fig 11.(Fig 9 – 13)
9. Pour tap water into the top of the milk outlet (Fig 14). If water does not pour from the two outlets as shown, soak it for another 30 min and retest. If you are not able to clean the outlet, order in another outlet. (Part no. 70007)
10. Re-assemble the auto frother ensuring that the arrow tips line up. (Fig 15)
11. Refit the auto frother, cover, splash guard and test. If the problem has not been solved ph 1300 365 487.



Figure 1



Figure 2



Figure 3



Figure 4



Figure 5



Figure 6



Figure 7



Figure 8



Figure 9 (Milk path)



Figure 10 (Milk path)



Figure 11 (Milk path)



Figure 12 (Air path)



Figure 13 (Steam path)



Figure 14 (Test outlet)



Figure 15

Welcome to My Coffee Shop!

Our hours of operation are Monday – Friday 9am to 5pm. Or you can visit us at your convenience on the web at www.mycoffeeshop.com.au. Orders and service requests can be placed by:

Phone: 1300 365 487
Fax: 02 9692 8046
E-mail: clientservices@mycoffeeshop.com.au
Online: www.mycoffeeshop.com.au/shop-online
Remittances: accountsreceivable@mycoffeeshop.com.au
Service enquiries: servicecentre@mycoffeeshop.com.au

Next business day delivery via courier to:

Adelaide Canberra Melbourne Sydney

for product orders placed by 1.30pm

Please note you will be advised when ordering if delivery charges apply to your order

Once again, welcome to My Coffee Shop and remember we are here to help. If you have any questions please don't hesitate to contact us.

We look forward to exceeding your expectations and making your day easier and more enjoyable.

Kind regards,

My Coffee Shop
Client Services
My Coffee Shop Pty Ltd



My Coffee Shop Pty Ltd
ACN 102 850 037

390 Johnston St
Abbotsford VIC 3067
ph: 03 9946 4160 fax:

97 / 1-5 Harwood St
Pyrmont NSW 2009
ph: 02 9034 6580