

jura®



GIGA X3c Professional Instructions for Use



Original instructions for use

Before using the machine read the instructions for use.

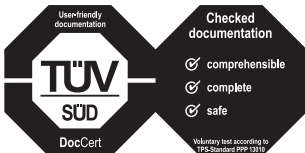

Instructions for use has been awarded the seal of approval by the independent German Technical Inspection Agency, TÜV SÜD, due to its easy-to-understand style, its thoroughness and coverage of safety aspects.



Your GIGA X3c Professional

| | |
|--|-----------|
| Control elements | 4 |
| Important information | 6 |
| Proper use | 6 |
| For your safety..... | 6 |
| 1 Preparing and using for the first time | 10 |
| JURA on the Internet..... | 10 |
| Requirements for first-time use | 10 |
| Setting up the machine | 10 |
| Filling the bean container..... | 10 |
| First-time use | 11 |
| Settings by the JURA service technician..... | 14 |
| Determining the water hardness | 15 |
| Connecting milk | 15 |
| 2 Preparation | 16 |
| Coffee, latte macchiato etc. – options for preparation | 16 |
| Preparation at the touch of a button..... | 17 |
| Preparation using the product selector | 18 |
| Ground coffee | 18 |
| Barista recipes at a glance | 19 |
| Preparing barista recipes | 20 |
| Permanently setting amounts for the cup size | 20 |
| Hot water | 21 |
| 3 Daily operation | 22 |
| Switching on | 22 |
| Daily maintenance | 22 |
| Regular maintenance | 23 |
| Switching off | 23 |
| 4 Permanent settings in programming mode | 24 |
| Possible settings in programming mode | 24 |
| Product settings | 25 |
| Adjusting the product settings..... | 25 |
| Renaming a product..... | 27 |
| Adding products to the start screen..... | 28 |
| Setting the consistency of grind | 29 |
| Maintenance settings | 30 |
| Setting the water hardness | 31 |
| Energy-saving mode | 31 |
| Time and date..... | 32 |
| Timer | 33 |
| Automatic switch-off | 34 |
| Units | 35 |
| Restore factory settings | 35 |

| | |
|--|-----------|
| Language | 36 |
| Display settings | 36 |
| Background | 37 |
| Deactivating barista recipes | 37 |
| Querying information | 38 |
| 5 Maintenance | 39 |
| Rinsing the coffee system | 39 |
| Rinsing the milk system | 39 |
| Cleaning the milk system | 40 |
| Dismantling and rinsing the dual spout | 41 |
| Changing the filter | 43 |
| Cleaning the machine | 44 |
| Descaling the machine | 45 |
| Cleaning the bean container | 47 |
| 6 Display messages | 49 |
| 7 Troubleshooting | 51 |
| 8 Transport and environmentally friendly disposal | 52 |
| Transport / Emptying the system | 52 |
| Disposal | 52 |
| 9 Technical data | 53 |
| 10 Index | 54 |
| 11 JURA contact details / Legal information | 60 |

Symbol description

Warnings

| | |
|--|--|
|  WARNING | Always take note of any information marked with the words CAUTION or |
|  CAUTION | WARNING and a warning sign. The signal word WARNING draws your attention to potential serious injury, and the signal word CAUTION to potential minor injury. |
| CAUTION | CAUTION draws your attention to potential damage to the machine. |

Symbols used

| | |
|---|---|
|  | Prompt to take action. This symbol means that you are being prompted to perform some action. |
|---|---|

| | |
|---|--|
|  | Information and tips to make it even easier to use your GIGA. |
|---|--|

| | |
|------------|----------------|
| 'Espresso' | Display |
|------------|----------------|

Control elements

Control elements

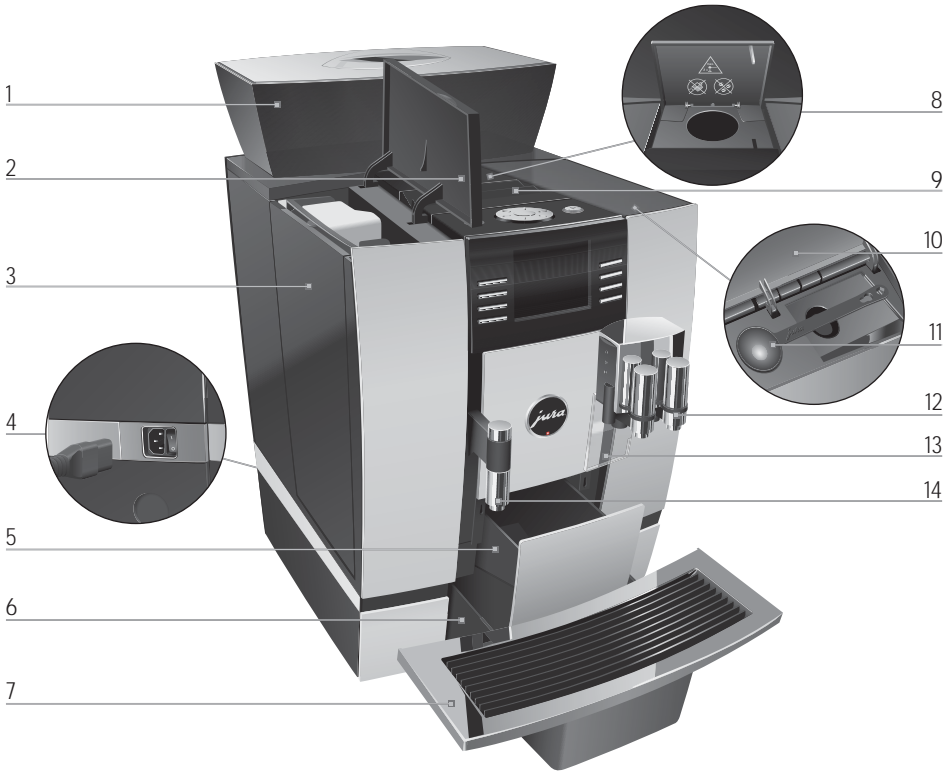

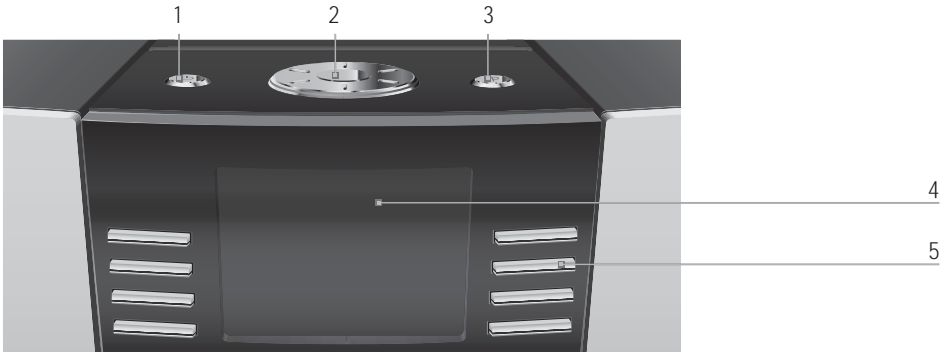

- 1 Bean container with aroma preservation cover
- 2 Water tank cover
- 3 Water tank
- 4 Power switch and plug-in mains cable (back of the machine)
- 5 Coffee grounds container
- 6 Drip tray
- 7 Cup grille

- 8 Filler funnel for ground coffee
- 9 Ventilation slats
- 10 Storage compartment cover
- 11 Measuring spoon for ground coffee
- 12 Height- and width-adjustable dual spout
- 13 Splash guard
- 14 Height-adjustable hot-water spout



Top of the machine

- 1  On/Off button
- 2  Rotary Switch
- 3  P button (programming)

Front

- 4 Display
- 5 Multi-function buttons (button function depends on what is shown in the display)

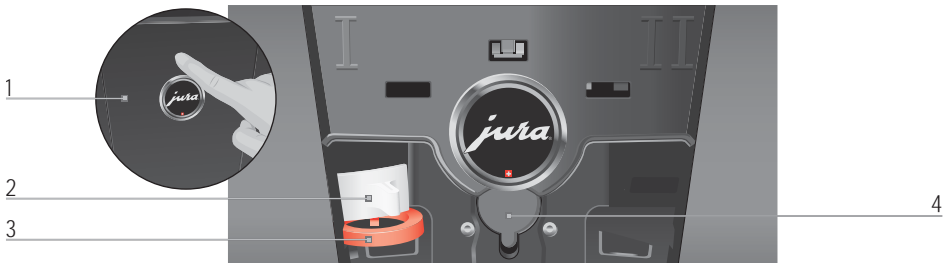

Back of the machine

- 1 Service cover
(open by pressing with your finger)
- 2 Locking device
- 3 Sliding catch
- 4 Service socket (underneath cover)

Important information

Proper use

This machine is intended for use by specialist or trained staff in businesses, light industry and agricultural facilities or for commercial use by non-professionals. It should only be used for coffee preparation and to heat milk and water. Use for any other purpose will be deemed improper. JURA Elektroapparate AG cannot accept any responsibility for the consequences of improper use.

Before using the machine read these instructions for use thoroughly and completely and comply with the instructions they contain. A warranty service is not applicable for damage or defects caused by non-compliance with the instructions for use. Keep these instructions for use close to the machine and pass them on to the next user.

The GIGA may only be operated by instructed persons. Non-professionals must be supervised during use.

For your safety



Please carefully read and observe the important safety information set out below.

To avoid danger of potentially fatal electric shock:

- Never use a machine which is damaged or has a defective mains cable.
- In the event of signs of damage, for example if there is a smell of burning, unplug the machine immediately from the mains supply and contact JURA service.
- If the mains cable of this machine is damaged, it must be repaired either directly by JURA or by an authorised JURA service centre.

- Make sure that the GIGA and the mains cable are not located close to hot surfaces.
- Be careful to ensure that the mains cable is not trapped and does not rub against sharp edges.
- Never open and repair the machine yourself. Do not modify the machine in any way that is not described in these instructions for use. The machine contains live parts. If opened, there is a danger of potentially fatal injury. Repairs may only be carried out by authorised JURA service centres, using original spare parts and accessories.
- To completely and safely disconnect the machine from the power supply, first switch off the GIGA using the On/Off button and then at the power switch. Only then should you remove the mains plug from the power socket.

There is a risk of scalds or burns on the spouts.

- Place the machine out of the reach of children.
- Do not touch any hot parts. Use the handles provided.

A defective machine is not safe and could cause injury or fire. To avoid damage and any associated risk of injury or fire:

- Only connect the machine to the mains voltage in accordance with the information on the rating plate. The rating plate is located on the underside of your GIGA. Further technical data is provided in these instructions for use (see Chapter 9 'Technical data').
- Connect the GIGA directly to a domestic power socket. Using multi-socket adapters or extension cords may cause overheating.

Important information

- Never allow the mains cable to loosely hang down. The mains cable could pose a tripping hazard or become damaged.
- Protect the GIGA from environmental influences such as rain, frost and direct sunlight.
- Do not immerse the GIGA, mains cable or connections in water.
- Do not put the GIGA or any individual parts in the dishwasher.
- Switch your GIGA off at the power switch before any cleaning operation. Always wipe the GIGA with a damp cloth rather than a wet one, and protect it from prolonged exposure to water splash.
- The GIGA is not suitable for installation on a surface where a jet of water can be used.
- The machine must not be cleaned with a jet of water.
- Please only use original JURA maintenance products. Use of products that are not explicitly recommended by JURA could damage the GIGA.
- Do not use any coffee beans treated with additives or caramelised coffee beans.
- Only fill the water tank with fresh, cold water.
- Switch the machine off at the power switch if you are going to be absent for a longer period of time.
- Children may not clean or service the machine unless supervised by a responsible person.
- Do not allow children to play with the machine.
- Keep children under the age of 8 away from the machine, or supervise them constantly.

- Children aged 8 and over may only operate the machine without supervision if they have been instructed in how to use it safely. Children must be able to recognise and understand the potential dangers arising from incorrect use.

People, including children, who

- do not have the physical, sensory or mental capabilities to use the machine safely or
- are inexperienced or lack knowledge in how to use the machine safely

must be supervised by a responsible person when using it, or must be instructed in how to use it correctly.

Safety when handling the CLARIS filter cartridge:

- Filter cartridges should be kept out of the reach of children.
- Store filter cartridges in a dry place in the sealed packaging.
- Protect cartridges from heat and direct sunlight.
- Do not use damaged filter cartridges.
- Do not open filter cartridges.

1 Preparing and using for the first time

JURA on the Internet

Visit us on the Internet. On the JURA website (www.jura.com) you will find interesting and up-to-date information on your GIGA and on every aspect of coffee.

Requirements for first-time use

A few preparations are necessary before the JURA service technician can set up your GIGA in your home. The following preparations must be carried out by a **professionally qualified person**:

- The mains connection for the GIGA must be protected by a residual current device (RCD).
- There must be a power switch to disconnect the power supply to the GIGA.
- The permanent water connection must have a shut-off valve with a non-return valve (type EA) and filter.
- The permanent water connection must comply with the specified technical data (see Chapter 9 'Technical data').
- The drain hose must be connected to a siphon.

i These preparations must be carried out by a qualified person.

i The preparations must be carried out before the JURA service technician sets up your GIGA in your home.

Setting up the machine

When setting up your GIGA, please note the following:

- Place the GIGA on a horizontal surface that is not sensitive to water.
- Choose a spot for your GIGA which protects the machine against overheating. Ensure that the ventilation slats are not covered.

Filling the bean container

The bean container has an aroma preservation cover. This will ensure that your coffee beans retain their aroma for longer.

CAUTION

Coffee beans which have been treated with additives (e.g. sugar), ground coffee or freeze-dried coffee will damage the grinder.

- ▶ Only use roasted, untreated coffee beans to fill the bean container.

▶ Remove the aroma preservation cover.

- ▶ Remove any dirt or foreign objects from inside the bean container.
- ▶ Fill the bean container with coffee beans and close the aroma preservation cover.

First-time use

- i** Before the machine is used for the first time, the permanent water connection must be installed by a JURA service technician.

During first-time use, you can choose between the ‘Quick installation’ and the ‘standard installation’ (‘Programming’):

- ‘Quick installation’: After setting the time and date, your GIGA is ready for use.
- ‘Standard installation’ (‘Programming’): Here, you can also choose whether you want to operate your GIGA **with** or **without** an external CLARIS filter cartridge.
 - ‘Use filter’ / ‘Active’: Here, you can set the capacity of the external filter cartridge you are using.
 - ‘Use filter’ / ‘Inactive’: Here, you can set the water hardness of the water used. This setting influences when your GIGA prompts you to perform descaling. If you do not know the hardness of your water, you can find this out first (see Chapter 1 ‘Preparing and using for the first time – Determining the water hardness’).



⚠ WARNING

If the machine is operated with a defective mains cable, there is a danger of potentially fatal electric shock.

- ▶ Never use a machine which is damaged or has a defective mains cable.



Precondition: The bean containers have been filled.

- ▶ Connect the mains cable to the machine.
- ▶ Insert the mains plug into a power socket.
-  ▶ Switch on the GIGA using the power switch on the back of the machine.
-  ▶ Press the On/Off button to switch the GIGA on. ‘Welcome to JURA’ appears on the display. The display then shows the languages you can choose from.

1 Preparing and using for the first time

i To display more languages, press the **'Next'** button (bottom right).

▶ Press the button that corresponds to the language you want, e.g. **'English'**.

'Saved' appears briefly on the display to confirm the setting.
'First-time use'

i Now choose between **'Quick installation'** and **'standard installation'** (**'Programming'**).

Quick installation

▶ Press the **'Quick installation'** button.

'Time'

▶ Press the **'+'** or **'-'** button to set the hours.

▶ Press the **'Save'** button.

▶ Press the **'+'** or **'-'** button to set the minutes.

▶ Press the **'Save'** button.

'Saved' appears briefly on the display.

'Date'

▶ Press the **'+'** or **'-'** button to set the year.

▶ Press the **'Save'** button.

▶ Press the **'+'** or **'-'** button to set the month.

▶ Press the **'Save'** button.

▶ Press the **'+'** or **'-'** button to set the day.

▶ Press the **'Save'** button.

'Saved' appears briefly on the display.

'Press the Rotary Switch.', the Rotary Switch lights up.



▶ Press the Rotary Switch.

'System is filling.', the system fills up with water. The operation stops automatically. **'Welcome to JURA'**, **'Machine is heating.'** appears on the display.

'Machine is rinsing.', the machine rinses. Water flows out of the dual spout. The operation stops automatically. **'Please select product.'** appears on the display. Your GIGA is ready for use.

Standard installation

▶ Press the **'Programming'** button.

'Time'

▶ Press the **'+'** or **'-'** button to set the hours.

▶ Press the **'Save'** button.

- ▶ Press the '+' or '-' button to set the minutes.
- ▶ Press the 'Save' button.
'Saved' appears briefly on the display.
'Date'
- ▶ Press the '+' or '-' button to set the year.
- ▶ Press the 'Save' button.
- ▶ Press the '+' or '-' button to set the month.
- ▶ Press the 'Save' button.
- ▶ Press the '+' or '-' button to set the day.
- ▶ Press the 'Save' button.
'Saved' appears briefly on the display.
'Use filter'

i Now choose whether you operate your GIGA **with** or **without** the CLARIS filter cartridge.

Activating the filter

- ▶ Press the 'Active' button.
- ▶ Press the 'Save' button.
'Filter' / 'Filter capacity in litres'
- ▶ Press the '+' or '-' button to set the first digit of the filter capacity.

i You can also change the value by turning the Rotary Switch .

- ▶ Press the 'Save' button or the Rotary Switch  to confirm the setting for the first digit.
- ▶ Now select the other digits for filter capacity.
'Saved' appears briefly once the last digit has been confirmed.
'Machine is heating.', 'Press the Rotary Switch.'



- ▶ Press the Rotary Switch.
'System is filling.', the system fills up with water. The operation stops automatically.
'Machine is rinsing.', the machine rinses. Water flows out of the dual spout. The operation stops automatically. 'Please select product.' appears on the display. Your GIGA is ready for use.

1 Preparing and using for the first time

Deactivating the filter

- ▶ Press the **'Inactive'** button.
- ▶ Press the **'Save'** button.
'Water hardness'

i If you do not know the hardness of your water, you must find this out first (see Chapter 1 'Preparing and using for the first time – Determining the water hardness').

- ▶ Press the **'+'** or **'–'** button to adjust the water hardness.
- ▶ Press the **'Save'** button.

'Saved' appears briefly on the display.

'Machine is heating.', **'Press the Rotary Switch.'**



- ▶ Press the Rotary Switch.

'System is filling.', the system fills up with water. The operation stops automatically.

'Machine is rinsing.', the machine rinses. Water flows out of the dual spout. The operation stops automatically. **'Please select product:'** appears on the display. Your GIGA is ready for use.

Settings by the JURA service technician

The following settings can only be made by the JURA service technician:

- Disabling the product selector view (see Chapter 2 'Preparation – Preparation using the product selector')
- Switching off pre-brewing for every speciality coffee
- Codes: Four codes can be assigned. For each code, you can define which programme items are available or disabled. Each code corresponds to different authorisations. For instance, you can define that initiation of the maintenance programmes is disabled using a code.
- Blocking the 'Permanently setting the amount of water for the cup size' function
- Blocking the option of preparing a double product by pressing the appropriate single product twice
- Defining that a prompt to empty the drip tray does not appear after cleaning

You can also obtain the following optional accessories for your GIGA from your JURA service partner:

- Coffee grounds disposal function set

Determining the water hardness

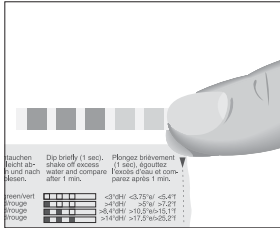

You can find out what the water hardness is by using the Aquadur® test strip supplied as standard.



- ▶ Hold the test strip briefly (for 1 second) under flowing water. Shake off the water.
- ▶ Wait for about 1 minute.
- ▶ You will then be able to read the degree of water hardness from the discolouration of the Aquadur® test strip and the description on the packaging.

Connecting milk

Your GIGA creates fine, creamy, feather-light milk foam with a perfect consistency. The most important requirement for frothing milk is a milk temperature of 4–8 °C. We would therefore recommend using a milk cooler (e.g. the JURA Compressor Cooler Pro, which is available as an option).

- ▶ Connect the milk pipe to the dual spout. To do this, attach the end of the milk pipe to the connector on the right-hand side of the dual spout.
- ▶ Connect the other end of the milk pipe to a milk cooler.

2 Preparation

- i** While a product is being prepared, you can stop preparation at any time. To do this, press the Rotary Switch  or the 'L' button.
- i** During preparation, you can change the preset **amounts** (e.g. amount of milk foam or water) by turning the Rotary Switch .
- i** You can follow the current status of preparation on the display.

Coffee tastes best served hot. A cold porcelain cup cools the beverage – and impairs the taste. We therefore recommend prewarming the cups. The full coffee aroma can develop only in prewarmed cups. You can purchase a JURA cup warmer from your specialised dealer.

You can make **permanent settings** for all products in programming mode (see Chapter 4 'Permanent settings in programming mode – Adjusting the product settings').

Coffee, latte macchiato etc. – options for preparation

The GIGA provides you with two options for preparing a speciality coffee, milk or hot water.

- **Preparation at the touch of a button:** Simply press the corresponding preparation button for the product shown on the display (start screen) that you want.
- **Preparation using the product selector (Rotary Selection):** Only some of the products you can prepare are shown on the start screen. As soon as you turn the Rotary Switch, more products are displayed in a **product selector**.
 - Turn the Rotary Switch to bring the product you want into focus. Start preparation by pressing the Rotary Switch or the 'Prepare' button.
 - The product selector view disappears automatically after 5 seconds if no preparation is started.

The two preparation options will now be described in more detail in the following sections.

Preparation at the touch of a button

Speciality coffees at the touch of a button

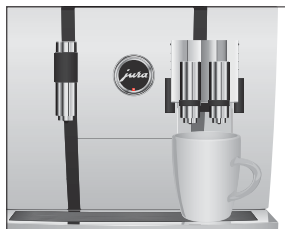

On the display (start screen), you will see various products, which you can prepare by simply pressing the corresponding button.

A speciality coffee displayed on the start screen is always prepared following the same model.

Example: Proceed as follows to prepare one coffee.

Precondition: 'Please select product:' is displayed.

- ▶ Place a cup under the dual spout.
- ▶ Press the 'Coffee' button.

Preparation starts. 'Coffee' and the fill volume are displayed. The preset amount of water for coffee flows into the cup. Preparation stops automatically. 'Please select product:' appears on the display.

Two speciality coffees at the touch of a button

Two speciality coffees can always be prepared in the same way: Press the preparation button you want **twice within two seconds**.

Speciality coffees with milk at the touch of a button

Your GIGA prepares latte macchiato, cappuccino and other speciality coffees with milk at the touch of a button. There is no need to move the glass or cup.

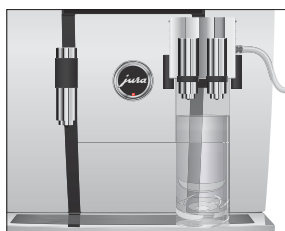

Example: Proceed as follows to prepare one latte macchiato.

Precondition: 'Please select product:' is displayed, milk is connected to the dual spout.

- ▶ Place a glass under the dual spout.
- ▶ Press the 'Latte macchiato' button.

'Latte macchiato', the preset amounts of milk and milk foam flow into the glass.

Coffee preparation starts. The preset amount of water for espresso flows into the glass. Preparation stops automatically. 'Please select product:' appears on the display.

To ensure that the milk system in the dual spout always works properly, you must clean it **daily** (see Chapter 5 'Maintenance – Cleaning the milk system').

2 Preparation

Preparation using the product selector

As soon as you turn the Rotary Switch, more products are displayed in a **product selector**.

- i** The product selector view disappears automatically after 5 seconds if no preparation is started.

Preparation of a speciality coffee using the product selector

Example: Proceed as follows to prepare a caffè latte using the product selector.

Precondition: 'Please select product:' is displayed, milk is connected to the dual spout.

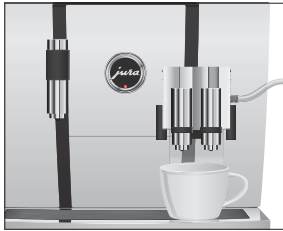

▶ Place a cup under the dual spout.



▶ Turn the Rotary Switch to view the product selector.



▶ Turn the Rotary Switch until the 'Caffè latte' product is in focus.



▶ Press the Rotary Switch to start preparation.

The caffè latte is prepared.

Preparation stops automatically. 'Please select product:' appears on the display.

Ground coffee

You can choose to use another coffee variety, for example decaffeinated coffee, with the filter funnel for ground coffee.

- i** Never add more than two level measuring spoons of ground coffee.
- i** Use ground coffee which is not ground too finely. Very fine coffee can block up the system so that the coffee only comes out in drips.
- i** If you did not fill the machine with a sufficient amount of ground coffee, 'Not enough ground coffee.' is displayed and the GIGA stops the operation.
- i** The desired speciality coffee must be prepared within approximately one minute after filling with the ground coffee. Otherwise the GIGA stops the operation and is once more ready for use.

All speciality coffees with ground coffee are always prepared following the same model.

Example: Proceed as follows to prepare one coffee using ground coffee.

Precondition: 'Please select product:' is displayed.



- ▶ Place a cup under the dual spout.
- ▶ Open the cover of the filler funnel for ground coffee.
'Please add ground coffee.'
- ▶ Place one level measuring spoon of ground coffee into the filler funnel.
- ▶ Close the cover of the filler funnel.
'Please select product:', the speciality coffees you can prepare with ground coffee are displayed.
- ▶ Press the 'Coffee' button.
Preparation starts. 'Coffee' and the fill volume are displayed. The preset amount of water for coffee flows into the cup. Preparation stops automatically. 'Please select product:' appears on the display.

Barista recipes at a glance

Now you too can be a professional barista! You can select the recipes for 12 delicious coffee creations from the product selector using the Rotary Switch. The GIGA will guide you through each step of the preparation process with easy-to-follow text and pictures. Choose from:

- Marocchino
- Pepresso
- White Cool
- Flavoured latte macchiato
- Irish coffee*
- Café mélange
- Viennese coffee
- Winter Magic
- Shakerato
- Mango Lassi
- Red Cool*
- Summer Fire

Designed to please the eye as well as the taste buds!
(Recipes marked * contain alcohol.)



Preparing barista recipes

All barista recipes are always prepared following the same model.

- i** The product selector view disappears automatically after 5 seconds if no preparation is started.

Example: Proceed as follows to prepare a White Cool.

Precondition: 'Please select product:' is displayed.

-  ▶ Turn the Rotary Switch to view the product selector.
-  ▶ Turn the Rotary Switch until the 'White Cool' product is in focus.
-  ▶ Press the Rotary Switch to start preparation.
 - ▶ Follow the instructions on the display and confirm by pressing the 'Next' button.

- i** You can stop preparation at any time by pressing the 'L' button.

- i** You cannot make any permanent settings for barista recipes. During preparation, you can however change the coffee strength and quantities by turning the Rotary Switch .

Permanently setting amounts for the cup size

It is easy to make permanent settings for the amounts (amount of water, amount of milk etc.) according to the cup size for all products except caffè latte. Adjust the amount once as shown in the following example. Every time you prepare a drink in the future, this amount will be dispensed.

The permanent settings for adapting the amounts to the cup size for all products always follows the same model.

Example: Proceed as follows to **permanently** set the amount of water for one coffee.

Precondition: 'Please select product:' is displayed.

- ▶ Place a cup under the dual spout.
- ▶ Press and **hold** the 'Coffee' button.
 - 'Coffee' and the fill volume are displayed.
- ▶ **Hold** the 'Coffee' button down until 'Enough coffee? Press button.' appears.
- ▶ Release the 'Coffee' button.
 - Preparation starts and the coffee flows into the cup.



- ▶ Press any button as soon as there is sufficient coffee in the cup.

Preparation stops. 'Saved' appears briefly on the display. The set amount of water for one coffee is permanently stored.

'Please select product:' appears on the display.

- i** You can alter this setting at any time by repeating the above procedure.
- i** The amount can be permanently adjusted to the cup size for the products shown in the product selector too. To do this, press and hold the Rotary Switch  until 'Enough coffee? Press button.' appears.
- i** You can also permanently set the amount for all speciality coffees, milk and hot water in programming mode (see Chapter 4 'Permanent settings in programming mode – Adjusting the product settings').

Hot water

The following temperatures can be selected for preparing hot water: 'Low', 'Normal', 'High'.

CAUTION

There is a danger of scalding from hot water splashes.

- ▶ Avoid direct contact with the skin.

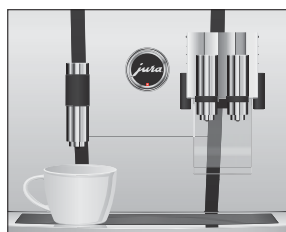

Precondition: 'Please select product:' is displayed.

- ▶ Place a cup under the hot-water spout.
 - ▶ Press the 'Hot water' button.
- 'Hot water' and the temperature are displayed.

- i** By pressing the '+' or '-' button (**within approximately 2 seconds**) you can set the temperature to your individual preference. This setting is not saved.

'Hot water', hot water flows into the cup. Preparation stops automatically when the preset amount of water is reached.

'Please select product:' appears on the display.

3 Daily operation

Switching on

When the GIGA is switched on, a rinse operation is automatically initiated. In programming mode you can change this setting so that the machine prompts you to perform the switch-on rinse by pressing the Rotary Switch  (see Chapter 4 'Permanent settings in programming mode – Maintenance settings').

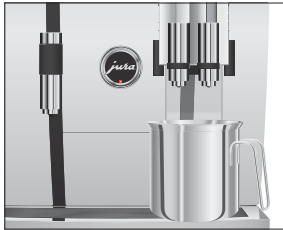

Precondition: Your GIGA is switched on at the power switch.

- ▶ Place a receptacle under the dual spout.
-  ▶ Press the On/Off button to switch the GIGA on.
'Welcome to JURA' appears on the display. The machine heats up.
'Machine is rinsing.', the machine rinses. Water flows out of the dual spout. The operation stops automatically. 'Please select product:' appears on the display.

Daily maintenance

To ensure that you get many years of reliable service out of your GIGA and to guarantee the optimum coffee quality, the machine requires daily maintenance.

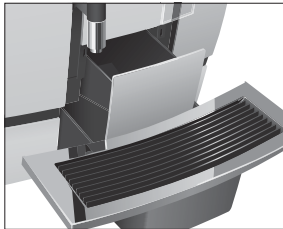

- ▶ Pull out the drip tray.
- ▶ Empty the coffee grounds container and the drip tray. Rinse them both with warm water.
- i** Always empty the coffee grounds container when the machine is **switched on**. This is the only way of resetting the coffee grounds counter.
- ▶ Refit the coffee grounds container and the drip tray.
- ▶ Remove the milk pipe and rinse it thoroughly under running water.
- ▶ Dismantle and rinse the dual spout (see Chapter 5 'Maintenance – Dismantling and rinsing the dual spout').
- ▶ Wipe the surface of the machine with a clean, soft, damp cloth (e.g. microfibre cloth).

Regular maintenance

Carry out the following maintenance actions **regularly** or **as required**:

- In the interests of hygiene, we recommend changing the milk pipe on a regular basis (approximately every 3 months). Replacement pipes are available from specialised dealers (JURA original accessory set for frothers).
- Traces of milk and coffee may stick to the top and bottom of the cup grille. If this happens, clean the cup grille.

Switching off

When you switch off your GIGA, the dual spout is rinsed automatically.

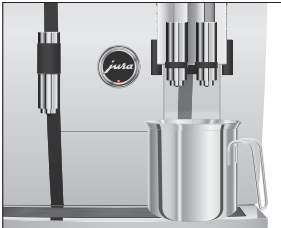

Precondition: 'Please select product:' is displayed.

- ▶ Place a receptacle under the dual spout.
 - 🔌 ▶ Press the On/Off button.
- 'Machine is rinsing.', 'Milk system is being rinsed.' (if you have prepared a speciality coffee with milk). The system rinses itself. The operation stops automatically. Your GIGA is switched off.

- i** When the GIGA is switched off with the On/Off button, the machine consumes less than 0.1 W of standby energy. The machine can be completely disconnected from the power supply using the power switch.

4 Permanent settings in programming mode

Possible settings in programming mode

Press the P button to enter programming mode. You can navigate through the programme items and permanently save the required settings simply by turning the Rotary Switch and using the multi-function buttons. The following settings can be made:

| Programme item | Sub-item | Explanation |
|----------------------------|---|---|
| 'Maintenance status (1/5)' | 'Clean', 'Change the filter', 'Descale' (only if filter is not activated), 'Rinse the milk system', 'Rinse the coffee system', 'Clean the milk system' | ▶ Start the required maintenance programme here. |
| 'Product settings (2/5)' | 'Programming', 'Classic-library', 'Set consistency of grind' | ▶ Select your settings for speciality coffees, milk and hot water. ▶ Replace the products on the start screen and in the product selector with your favourites, or prepare your chosen product directly. ▶ Adjust the consistency of grind to the coffee beans used. |
| 'Machine settings (3/5)' | 'Maintenance settings' (filter, water hardness, switch-on rinse, milk system rinsing), 'Time / date', 'Timer', 'Save energy', 'Units', 'Factory setting' | ▶ Set the water hardness or activate the filter. ▶ Change the settings for the switch-on rinse and milk system rinse. ▶ Set the time after which the GIGA should switch off automatically. ▶ Select an energy-saving mode. ▶ Select the unit for the amount of water. ▶ Reset the machine or the permanently set values of all products to the factory settings. |
| 'Machine settings (4/5)' | 'Choose language', 'Display', 'Colour scheme', 'Barista recipes' | ▶ Select your language. ▶ Change the display settings. ▶ Activate or deactivate barista recipes. |
| 'Information (5/5)' | 'Product counter', 'Day counter', 'Maintenance counter', 'Version' | ▶ Keep track of all products prepared and view the number of maintenance programmes performed. |

Product settings

In the programme item ‘**Product settings (2/5)**’ you can make the following settings:

- **‘Programming’**
 - Set individual settings for all speciality coffees, milk and hot water (see Chapter 4 ‘Permanent settings in programming mode – Adjusting the product settings’).
 - Change the names of individual products (see Chapter 4 ‘Permanent settings in programming mode – Renaming a product’).
- **‘Classic-library’**
 - Find all products stored as standard in your GIGA and prepare these directly.
 - Replace the products on the start screen and in the product selector with your favourites (see Chapter 4 ‘Permanent settings in programming mode – Adding products to the start screen’).

Adjusting the product settings

The following settings can be made in ‘**Product settings (2/5)**’ / ‘**Programming**’:

| Product | Coffee strength | Amount | More settings |
|---|--|---|---|
| Ristretto, Espresso, Coffee* | ● (extra-mild), ●● (mild), ●●● (normal), ●●●● (strong), ●●●●● (extra-strong) | Amount of coffee: 25 ml – 290 ml | Temperature (low, normal, high), Product name |
| 2 ristretti, 2 espressi, 2 coffees | – | Amount of coffee: 25 ml – 290 ml (per cup) | Temperature (low, normal, high), Product name |
| Cappuccino*, Espresso macchiato*, Latte macchiato, Flat white | ● (extra-mild), ●● (mild), ●●● (normal), ●●●● (strong), ●●●●● (extra-strong) | Amount of coffee: 25 ml – 290 ml Milk: 0 sec. – 120 sec. Milk foam: 0 sec. – 120 sec. Interval: 0 sec. – 120 sec. | Temperature (low, normal, high), Product name |

4 Permanent settings in programming mode

| Product | Coffee strength | Amount | More settings |
|--|--|--|---|
| 2 cappuccini, 2 caffè latte, 2 espressi macchiati, 2 latte macchiati, 2 flat whites | – | Amount of coffee: 25 ml – 290 ml Milk: 0 sec. – 120 sec. Milk foam: 0 sec. – 120 sec. (per cup) Interval: 0 sec. – 120 sec. | Temperature (low, normal, high), Product name |
| Caffè latte* | ☉ (extra-mild), ☉☉ (mild), ☉☉☉ (normal), ☉☉☉☉ (strong), ☉☉☉☉☉ (extra-strong) | Amount of coffee: 25 ml – 290 ml Milk: 0 sec. – 120 sec. Milk foam: 0 sec. – 120 sec. | Temperature (low, normal, high), Product name |
| Portion of milk foam, Portion of milk* | – | Milk: 0 sec. – 120 sec. Milk foam: 0 sec. – 120 sec. | Product name |
| 2 portions of milk foam, 2 portions of milk | – | Milk: 0 sec. – 120 sec. Milk foam: 0 sec. – 120 sec. (per cup) | Product name |
| Pot, Pot 2 | ☉ (extra-mild), ☉☉ (mild), ☉☉☉ (normal), ☉☉☉☉ (strong), ☉☉☉☉☉ (extra-strong) | Amount of coffee: 25 ml – 290 ml (per stroke) | Temperature (low, normal, high), Number of strokes (1–5; set number is displayed during preparation), Product name |
| Hot water* | – | Water: 25 ml – 450 ml | Temperature (low, normal, high), Product name |

(Products marked * are also available in 'large' size.)

i In addition to the settings listed, you can **reset the values for all products to the factory settings.**

Example: Proceed as follows in the 'Expert mode' to change the amount of milk for a latte macchiato from '4 sec.' to '6 sec.', the amount of milk foam from '12 sec.' to '14 sec.' and the amount of water from '45 ml' to '40 ml'.

Precondition: 'Please select product:' is displayed.

P ▶ Press the P button.

'Maintenance status (1/5)'

-  ▶ Turn the Rotary Switch until the programme item **'Product settings (2/5)'** is displayed.
 - ▶ Press the **'Expert mode'** button.
 - 'Expert mode'**
- i** Next select the button of the product for which you would like to make settings. No product is prepared at this point.
- i** You can also select the products in the product selector. To do this, turn the Rotary Switch to view the product selector.
 - ▶ Press the **'Latte macchiato'** button.
 - ▶ Press the **'Amount of milk'** button.
 - ▶ Press the **'+' or '-'** button to change the setting for the amount of milk to **'6 sec.'**
 - ▶ Press the **'Save'** button.
 - ▶ Press the **'Amount of milk foam'** button.
 - ▶ Press the **'+' or '-'** button to change the setting for the amount of milk foam to **'14 sec.'**
 - ▶ Press the **'Save'** button.
 - ▶ Press the **'Volume'** button.
 - ▶ Press the **'+' or '-'** button to change the setting for the fill volume to **'40 ml'**.
 - ▶ Press the **'Save'** button.
- P** ▶ Press the P button to exit programming mode.
 - 'Please select product:'**

Renaming a product





In the programme item **'Product settings (2/5) / 'Programming'** you can rename all of the products.

Example: Proceed as follows to change the product name from **'Espresso'** to **'My espresso'**.

Precondition: **'Please select product:'** is displayed.

- P** ▶ Press the P button.
 - 'Maintenance status (1/5)'**
-  ▶ Turn the Rotary Switch until the programme item **'Product settings (2/5)'** is displayed.
 - ▶ Press the **'Programming'** button.
 - 'Programming'**
 - ▶ Press the **'Espresso'** button.

4 Permanent settings in programming mode

- ▶ Press the 'Product name' button.
The available letters, numbers and special characters appear on the display.
- ▶ Keep pressing the '<' button until all letters have been deleted.
- i** By pressing the '^' button, you can switch between lower and upper case letters.
-  ▶ Turn the Rotary Switch until the letter 'M' is highlighted.
-  ▶ Press the Rotary Switch to confirm the letter 'M'.
- ▶ Press the '^' button to change to lower case.
-  ▶ Turn the Rotary Switch until the letter 'y' is highlighted.
-  ▶ Press the Rotary Switch to confirm the letter 'y'.
- ▶ Continue until 'My espresso' is displayed.
- ▶ Press the 'Save' button.
'Saved' appears briefly on the display.
'My espresso'
- P** ▶ Press the P button to exit programming mode.
'Please select product:'

Adding products to the start screen

In the programme item 'Product settings (2/5)' / 'Classic-library' you will find all the products stored as standard in your GIGA. You can move any of these products to your preferred position on the start screen or in the product selector and make it one of your favourites.

Example: Proceed as follows to display the product '2 espressi' in the **bottom right-hand corner** of the start screen.

Precondition: 'Please select product:' is displayed.

- P** ▶ Press the P button.
'Maintenance status (1/5)'
-  ▶ Turn the Rotary Switch until the programme item 'Product settings (2/5)' is displayed.
- ▶ Press the 'Classic-library' button.
'Classic-library'
- i** Next select the button of the product you want to move to the start screen. No product is prepared at this point.
- ▶ Press the '2 espressi' button.
'2 espressi'

- ▶ Press the 'Save' button.
- ▶ Press the 'Add to favourites' button.
'Select position'
- ▶ Press the button at the **bottom right** ('Milk').
'Do you want to replace the current product?'
- ▶ Press the 'Yes' button.
'Saved' appears briefly on the display.
'Classic-library'
- P ▶ Press the P button to exit programming mode.
'Please select product:'

Setting the consistency of grind

In the programme item 'Product settings (2/5)' / 'Set consistency of grind' you can adjust the grinder to the degree of roast of your coffee.

The consistency of grind is correct if the coffee flows regularly from the dual spout. In addition a fine, thick crema forms.

Precondition: 'Please select product:' is displayed.

- P ▶ Press the P button.
'Maintenance status (1/5)'
-  ▶ Turn the Rotary Switch until the programme item 'Product settings (2/5)' is displayed.
- ▶ Press the 'Set consistency of grind' button.
'Set consistency of grind'
- ▶ Press the '+' or '-' button to change the setting for the consistency of grind.
- ▶ Press the 'Save' button.
'Saved' appears briefly on the display.
'Set consistency of grind'
- P ▶ Press the P button to exit programming mode.
'Please select product:'

Maintenance settings

In the programme item 'Machine settings (3/5)' / 'Maintenance settings' you can make the following settings:

- 'Filter'
 - Choose whether to operate your GIGA with or without an external filter cartridge or change the filter capacity.
- 'Water hardness'
 - If you do not have a filter cartridge, you will need to set the water hardness (see Chapter 4 'Permanent settings in programming mode – Setting the water hardness').
- 'Switch-on rinse' / 'Manual'
 - The switch-on rinse must be started manually.
- 'Switch-on rinse' / 'Automatic'
 - The switch-on rinse is started automatically.
- 'Rinse the milk system' / 'Manual after 10 min.'
 - You are prompted to rinse the milk system 10 minutes after preparation of a speciality coffee with milk.
- 'Rinse the milk system' / 'Manual immediate'
 - You are prompted to rinse the milk system immediately after preparation of a speciality coffee with milk.
- 'Rinse the milk system' / 'Automatic after 10 min.'
 - Milk system rinsing is automatically initiated 10 minutes after preparation of a speciality coffee with milk.
- 'Rinse the milk system' / 'Automatic immediate'
 - Milk system rinsing is automatically initiated approx. 30 seconds after preparation of a speciality coffee with milk.

Example: Proceed as follows to make the machine prompt you to rinse the milk system **immediately** after preparing a speciality coffee with milk.

Precondition: 'Please select product:' is displayed.

- P ▶ Press the P button.
 - 'Maintenance status (1/5)'
- ⊙ ▶ Turn the Rotary Switch until the programme item 'Machine settings (3/5)' is displayed.
 - ▶ Press the 'Maintenance settings' button.
 - 'Maintenance settings'
 - ▶ Press the 'Rinse the milk system' button.
 - 'Rinse the milk system'
 - ▶ Press the 'Manual immediate' button.

- ▶ Press the 'Save' button.
'Saved' appears briefly on the display.
'Maintenance settings'

- P** ▶ Press the P button to exit programming mode.
'Please select product:'

Setting the water hardness

The harder the water is, the more frequently the GIGA needs to be descaled. It is therefore important to set the water hardness accurately.

The water hardness can be adjusted on a continuous scale between 1 °dH and 30 °dH.

- i** If you are using an external filter cartridge and have activated it, it is not possible to set the water hardness.

Precondition: 'Please select product:' is displayed.

- P** ▶ Press the P button.
'Maintenance status (1/5)'
-  ▶ Turn the Rotary Switch until the programme item 'Machine settings (3/5)' is displayed.
- ▶ Press the 'Maintenance settings' button.
'Maintenance settings'
 - ▶ Press the 'Water hardness' button.
'Water hardness'
 - ▶ Press the '+' or '-' button to adjust the water hardness.
 - ▶ Press the 'Save' button.
'Saved' appears briefly on the display.
'Maintenance settings'
- P** ▶ Press the P button to exit programming mode.
'Please select product:'

Energy-saving mode

In the programme item 'Machine settings (3/5)' / 'Save energy' you can permanently set an energy-saving mode (Energy Save Mode, E.S.M.®):

- 'Save No'
 - All speciality coffees, speciality coffees with milk and hot water can be prepared without having to wait.

4 Permanent settings in programming mode

- 'Save Level 1'
 - After switching on, your GIGA is only ready for use for speciality coffees and hot water. Before you can prepare a speciality coffee with milk, the machine must heat up.
 - Soon after the last preparation, the GIGA stops heating up. After about 5 minutes the message 'Energy Save' is displayed.
- 'Save Level 2'
 - After switching on, your GIGA is ready for use for all speciality coffees with and without milk, as well as hot water.
 - Soon after the last preparation, the GIGA stops heating up. After about 5 minutes the message 'Energy Save' is displayed.

Example: Proceed as follows to change the energy-saving mode from 'Save Level 1' to 'Save Level 2'.

Precondition: 'Please select product:' is displayed.

- P ▶ Press the P button.
'Maintenance status (1/5)'
-  ▶ Turn the Rotary Switch until the programme item 'Machine settings (3/5)' is displayed.
 - ▶ Press the 'Save energy' button.
'Save energy'
 - ▶ Press the 'Save Level 2' button.
 - ▶ Press the 'Save' button.
'Saved' appears briefly on the display.
'Machine settings (3/5)'
- P ▶ Press the P button to exit programming mode.
'Please select product:'

Time and date

You already set the time and date during first-time use. You can change this setting.

- i** For the time format, you can choose between '24 hrs' and 'AM / PM' (see Chapter 4 'Permanent settings in programming mode – Units').

Example: Proceed as follows to change the time.

Precondition: 'Please select product:' is displayed.

- P ▶ Press the P button.
‘Maintenance status (1/5)’
- ⊖ ▶ Turn the Rotary Switch until the programme item ‘Machine settings (3/5)’ is displayed.
 - ▶ Press the ‘Time / date’ button.
‘Time / date’
 - ▶ Press the ‘Time’ button.
‘Time’
 - ▶ Press the ‘+’ or ‘-’ button to set the hours.
 - ▶ Press the ‘Save’ button.
 - ▶ Press the ‘+’ or ‘-’ button to set the minutes.
 - ▶ Press the ‘Save’ button.
‘Saved’ appears briefly on the display.
‘Time / date’
- P ▶ Press the P button to exit programming mode.
‘Please select product:’

Timer

In the programme item ‘Machine settings (3/5)’ / ‘Timer’ you can set an individual switch-on and switch-off time for every day of the week.

- i** Automatic switch-on only works when the machine is switched on at the power switch.
- i** For the time format, you can choose between ‘24 hrs’ and ‘AM / PM’ (see Chapter 4 ‘Permanent settings in programming mode – Units’).

Example: Proceed as follows to set your GIGA to switch on and off at a time defined by you **every day of the week**.

Precondition: ‘Please select product:’ is displayed.

- P ▶ Press the P button.
‘Maintenance status (1/5)’
- ⊖ ▶ Turn the Rotary Switch until the programme item ‘Machine settings (3/5)’ is displayed.
 - ▶ Press the ‘Timer’ button.
‘Timer’
 - ▶ Press the ‘Monday’ button (example).
‘Monday’
 - ▶ Press the ‘+’ or ‘-’ button to set the hours (for ‘Switch machine on’).

4 Permanent settings in programming mode

- ▶ Press the '←' button.
 - ▶ Press the '+' or '-' button to set the minutes (for 'Switch machine on').
 - ▶ Press the '←' button.
 - ▶ Press the '+' or '-' button to set the hours (for 'Switch machine off').
 - ▶ Press the '←' button.
 - ▶ Press the '+' or '-' button to set the minutes (for 'Switch machine off').
 - ▶ Press the 'Every weekday' button.
'Saved' appears briefly on the display. The switch-on and switch-off times you just set are adopted for every day of the week.
'Timer'
- P ▶ Press the P button to exit programming mode.
'Please select product:'

Automatic switch-off

By instructing your GIGA to automatically switch itself off, you can cut down your energy consumption. If this function is activated, your GIGA switches off automatically after the preset time following the last action on the machine.

You can set the automatic switch-off time to 15 minutes or 0.5–15 hours.

Precondition: 'Please select product:' is displayed.

- P ▶ Press the P button.
'Maintenance status (1/5)'
- ⊙ ▶ Turn the Rotary Switch until the programme item 'Machine settings (3/5)' is displayed.
- ▶ Press the 'Timer' button.
 - ▶ Press the 'Next' button.
 - ▶ Press the 'Switch off after' button.
'Switch off after'
 - ▶ Press the '+' or '-' button to change the setting.
 - ▶ Press the 'Save' button.
'Saved' appears briefly on the display.
'Timer'
- P ▶ Press the P button to exit programming mode.
'Please select product:'

Units

In the programme item **'Machine settings (3/5) / 'Units'** you can make the following settings:

- Unit for amount of water: **'ml'** or **'oz'**
- Time format: **'24 hrs.'** or **'AM / PM'**

Example: Proceed as follows to change the unit for the amount of water from **'ml'** to **'oz'**.

Precondition: **'Please select product:'** is displayed.

- P** ▶ Press the P button.
'Maintenance status (1/5)'
-  ▶ Turn the Rotary Switch until the programme item **'Machine settings (3/5)'** is displayed.
- ▶ Press the **'Units'** button.
'Units'
- ▶ Press the **'oz'** button.
- ▶ Press the **'Save'** button.
'Saved' appears briefly on the display.
'Machine settings (3/5)'
- P** ▶ Press the P button to exit programming mode.
'Please select product:'

Restore factory settings

In the programme item **'Machine settings (3/5) / 'Factory setting'** you can reset various settings to their factory settings:

- **'All products'**
 - The settings (amount of water, coffee strength, temperature etc.) for **all products** are reset to the factory settings.
- **'Machine'**
 - **All user settings** (apart from the 'filter', 'water hardness' and time and date settings) are reset to the factory settings. The GIGA then switches off.
- **'Empty system'**
 - The system is emptied. Your GIGA then switches off.

Example: Proceed as follows to reset the values for **all products** to the factory settings.

Precondition: **'Please select product:'** is displayed.

- P** ▶ Press the P button.
'Maintenance status (1/5)'
-  ▶ Turn the Rotary Switch until the programme item **'Machine settings (3/5)'** is displayed.

4 Permanent settings in programming mode

- ▶ Press the 'Factory setting' button.
'Factory setting'
- ▶ Press the 'All products' button.
'All products' / 'Reset all products to the factory settings?'
- ▶ Press the 'Yes' button.
'Saved' appears briefly on the display.
'Factory setting'
- P ▶ Press the P button to exit programming mode.
'Please select product:'

Language

In this programme item you can set the language used by your GIGA.

Example: Proceed as follows to change the language from 'English' to 'Deutsch'.

Precondition: 'Please select product:' is displayed.

- P ▶ Press the P button.
'Maintenance status (1/5)'
-  ▶ Turn the Rotary Switch until the programme item 'Machine settings (4/5)' is displayed.
- ▶ Press the 'Choose language' button.
'Choose language'
- i** To display more languages, press the 'Next' button (bottom right).
 - ▶ Press the 'Deutsch' button.
'Gespeichert' appears briefly on the display.
'Geräteeinstellungen (4/5)'
- P ▶ Press the P button to exit programming mode.
'Bitte wählen Sie Ihr Produkt:'

Display settings

In the programme item 'Machine settings (4/5)' / 'Display' you can make the following settings:

- 'Brightness' (as percentages)
- 'Contrast' (high, normal, low)
- 'Backlight' (backlighting; as percentages)

Example: Proceed as follows to change the brightness of the display.

Precondition: 'Please select product:' is displayed.

- P ▶ Press the P button.
'Maintenance status (1/5)'

- ⊙ ▶ Turn the Rotary Switch until the programme item ‘Machine settings (4/5)’ is displayed.
- ▶ Press the ‘Display’ button.
- ▶ Press the ‘Brightness’ button.
- ▶ Press the ‘+’ or ‘-’ button to change the setting.
- ▶ Press the ‘Save’ button.
- ‘Saved’ appears briefly on the display.
- ‘Display’
- P ▶ Press the P button to exit programming mode.
- ‘Please select product:’

Background

In this programme item you can set the background for the display of your GIGA.

i The set background is only displayed on the start screen.

Precondition: ‘Please select product:’ is displayed.

- P ▶ Press the P button.
- ‘Maintenance status (1/5)’
- ⊙ ▶ Turn the Rotary Switch until the programme item ‘Machine settings (4/5)’ is displayed.
- ▶ Press the ‘Colour scheme’ button.
- ‘Colour scheme’
- ▶ Press the ‘+’ or ‘-’ button to change the setting.
- ▶ Press the ‘Save’ button.
- ‘Saved’ appears briefly on the display.
- ‘Machine settings (4/5)’
- P ▶ Press the P button to exit programming mode.
- ‘Please select product:’

Deactivating barista recipes

In the programme item ‘Machine settings (4/5)’ you can activate or deactivate the barista recipes. When the barista recipes are deactivated they no longer appear in the product selector.

Example: Proceed as follows to deactivate barista recipes.

Precondition: ‘Please select product:’ is displayed.

- P ▶ Press the P button.
- ‘Maintenance status (1/5)’

4 Permanent settings in programming mode

- ◉ ▶ Turn the Rotary Switch until the programme item 'Machine settings (4/5)' is displayed.
- ▶ Press the 'Barista recipes' button.
'Barista recipes'
- ▶ Press the 'Inactive' button.
- ▶ Press the 'Save' button.
'Saved' appears briefly on the display.
'Machine settings (4/5)'
- P ▶ Press the P button to exit programming mode.
'Please select product:'

Querying information

In the programme item 'Information (5/5)' you can view the following information:

- 'Product counter': Number of prepared speciality coffees, speciality coffees with milk and hot water
- 'Day counter': Number of prepared speciality coffees, speciality coffees with milk and hot water. This counter can be reset to zero.
- 'Maintenance counter': Number of maintenance programmes performed (cleaning, descaling etc.)
- 'Version': Software version

Precondition: 'Please select product:' is displayed.

- P ▶ Press the P button.
'Maintenance status (1/5)'
- ◉ ▶ Turn the Rotary Switch until the programme item 'Information (5/5)' is displayed.
- ▶ Press the 'Product counter' button.
'Product counter' and the number of products prepared is displayed.
- i You can also view the number of products prepared in the product selector. To do this, turn the Rotary Switch. Press the 'L' button to exit the product selector view again.
- ▶ Press any button or the Rotary Switch to exit the programme item.
'Information (5/5)'
- P ▶ Press the P button to exit programming mode.
'Please select product:'

5 Maintenance

Your GIGA has the following integrated maintenance programmes:

- Rinsing the coffee system ('**Rinse the coffee system**')
 - Rinsing the milk system in the dual spout ('**Rinse the milk system**')
 - Cleaning the milk system in the dual spout ('**Clean the milk system**')
 - Changing the filter ('**Change the filter**')
 - Cleaning the machine ('**Clean**')
 - Descaling the machine ('**Descale**') (only if filter is not activated)

i Clean or descale the machine, rinse the milk system or change the filter when you are prompted to do so.

i Press the P button to view a list of the maintenance programmes ('**Maintenance status (1/5)**'). When the bar is completely filled with red, your GIGA will prompt you to perform the appropriate maintenance programme.

i In the interests of hygiene, you should clean the milk system **daily** when you have been preparing milk.

Rinsing the coffee system

You can perform coffee system rinsing at any time.



Precondition: '**Please select product:**' is displayed.

▶ Place a receptacle under the dual spout.

P ▶ Press the P button.

'**Maintenance status (1/5)**'

▶ Press the '**Rinse the coffee system**' button.

'**Machine is rinsing.**', water flows out of the dual spout.

The rinse stops automatically. '**Please select product:**' appears on the display.

Rinsing the milk system

Depending on the setting in programming mode, the GIGA prompts you to rinse the milk system or automatically performs rinsing following milk preparation.

Example: Proceed as follows to rinse the milk system when prompted to do so.

Precondition: '**Rinse the milk system.**' and the symbol ☼ are displayed.

5 Maintenance

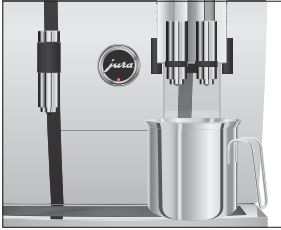

- ▶ Place a receptacle under the dual spout.
- P ▶ Press the P button.
‘Maintenance status (1/5)’
- ▶ Press the ‘Rinse the milk system’ button.
‘Milk system is being rinsed.’, water flows out of the dual spout.
The rinse stops automatically. ‘Please select product:’ appears on the display.

Cleaning the milk system

To ensure that the milk system in the dual spout always works properly, you must clean it **daily** when you have been preparing milk.

CAUTION

If the wrong cleaning agent is used, the machine could be damaged and/or traces could be left behind in the water.

- ▶ Use only original JURA maintenance products.

i JURA milk system cleaner is available from specialised dealers.

Precondition: ‘Please select product:’ is displayed.

- P ▶ Press the P button.
‘Maintenance status (1/5)’
- ▶ Press the ‘Clean the milk system’ button.
- ▶ Press the ‘Start’ button.
- ▶ Press the ‘Start’ button again.
‘Cleaning agent for milk system.’
- ▶ Pour 250 ml of fresh water into a receptacle and add one capful of milk system cleaner.
- ▶ Immerse the milk pipe in the receptacle.
- ▶ Place another receptacle under the dual spout.
- ▶ Press the ‘Next’ button.
‘Milk system is being cleaned.’, water flows out of the dual spout.
‘Water for cleaning milk system.’
- ▶ Rinse the receptacle thoroughly, fill it with 250 ml of fresh water and immerse the milk pipe in the water.





- ▶ Empty the other receptacle and place it under the dual spout again.
- ▶ Press the 'Next' button.
 'Milk system is being cleaned.', the dual spout and the pipe are rinsed with fresh water.
 The operation stops automatically. 'Milk system cleaning complete.' appears briefly on the display.
 'Please select product.'

Dismantling and rinsing the dual spout

The dual spout must be dismantled and rinsed **daily** if milk has been prepared to make sure it functions perfectly and also in the interests of hygiene.

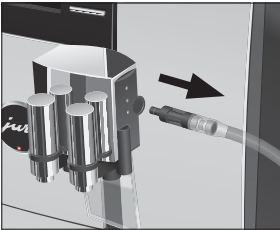

- ▶ Remove the milk pipe and rinse it thoroughly under running water.

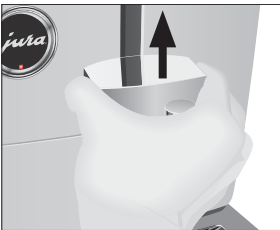

- ▶ Press the releasing devices and pull the cover of the dual spout up and off.

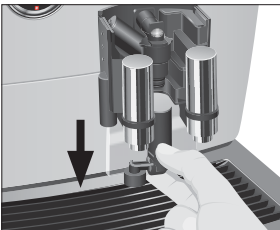

- ▶ Carefully pull the bottom part of the milk system down and off.

5 Maintenance

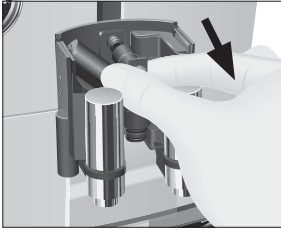

- ▶ Remove the milk system from the dual spout.

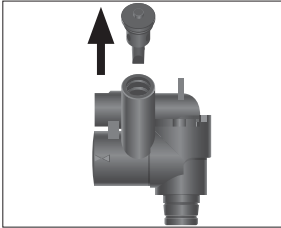

- ▶ Remove the air intake pipe.

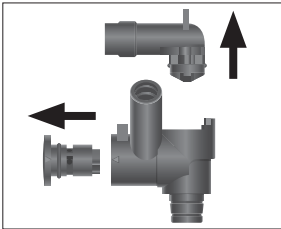

- ▶ Dismantle the milk system into its individual parts.
- ▶ Rinse all the parts under running water. If there are severely dried-on milk residues, firstly immerse the individual parts in a solution of 250 ml cold water and one capful of JURA milk system cleaner. Then rinse the parts thoroughly.

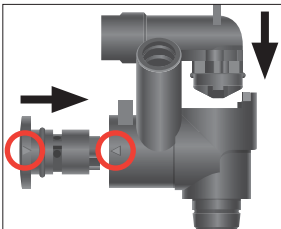

- ▶ Reassemble the milk system. When doing this, note the arrows (circled in red in the picture) on the individual parts.

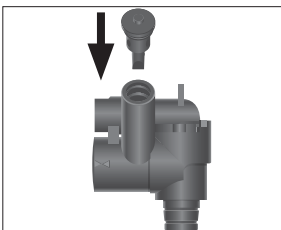

- ▶ Fit the air intake pipe.

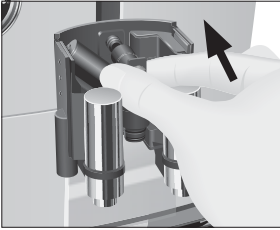

- ▶ Fit the assembled individual parts back in the dual spout and press it firmly.

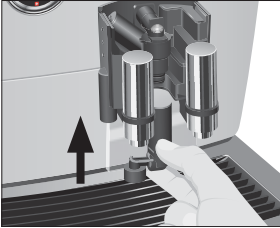

- ▶ Attach the bottom part of the milk system to the part already inserted from below.

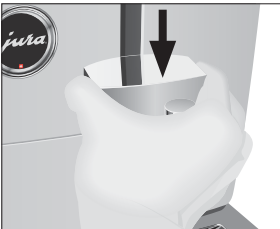

- ▶ Fit the cover of the dual spout. It will click into place audibly.

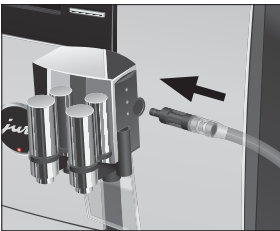

- ▶ Insert the milk pipe into the dual spout.

Changing the filter

- i** After the set amount of water has flowed through the external filter cartridge, it will cease to work. Your GIGA will automatically prompt you to change the filter.

Example: Proceed as follows to change the filter when prompted to do so.

Precondition: 'Change the filter' and the symbol  are displayed.

- ▶ Change the external filter cartridge as described in the instructions for the cartridge.

- P ▶ Press the P button.
‘Maintenance status (1/5)’
- ▶ Press the ‘Change the filter’ button.
‘Change the filter’ / ‘Do you really want to reset the filter capacity?’
- ▶ Press the ‘Yes’ button
‘Change the filter’ / ‘Filter capacity has been reset.’
‘Please select product.’ appears on the display.

Cleaning the machine

After 220 preparations or 80 switch-on rinses, the GIGA will prompt you to clean it.

CAUTION

If the wrong cleaning agent is used, the machine could be damaged and/or traces could be left behind in the water.

- ▶ Use only original JURA maintenance products.

- i** The cleaning programme lasts approximately 20 minutes.
- i** Do not interrupt the cleaning programme. The quality of cleaning will be impaired if you do so.
- i** JURA cleaning tablets are available from specialised dealers.

Example: Proceed as follows to clean when prompted to do so.

Precondition: ‘Clean machine.’ and the symbol ☼ are displayed.

- P ▶ Press the P button.
‘Maintenance status (1/5)’
- ▶ Press the ‘Clean’ button.
- ▶ Press the ‘Start’ button.
- ▶ Press the ‘Start’ button again.
‘Empty coffee grounds container.’
- ▶ Empty the drip tray and coffee grounds container and put them back into the machine.
‘Press the Rotary Switch.’
- ▶ Place a receptacle under the dual spout.
- ▶ Press the Rotary Switch.
‘Machine is being cleaned.’, water flows out of the dual spout.
The operation is interrupted, ‘Add cleaning tablet.’
- ▶ Open the cover of the filler funnel for ground coffee.

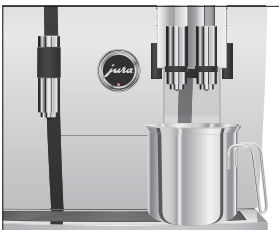

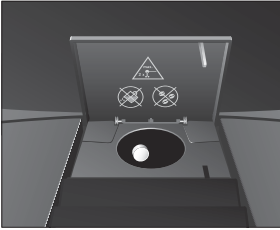

- ▶ Insert a JURA cleaning tablet into the filler funnel.
- ▶ Close the cover of the filler funnel.

'Press the Rotary Switch.'



- ▶ Press the Rotary Switch.

'Machine is being cleaned.', water flows out of the dual spout repeatedly.

The operation is interrupted, **'Empty coffee grounds container.'**

- ▶ Empty the drip tray and coffee grounds container and put them back into the machine.

'Clean' / 'Cleaning complete.'

Cleaning is now complete. Your GIGA is once more ready for use.

Descaling the machine

The GIGA builds up deposits of limescale over time and automatically prompts you to descale it when necessary. The degree of calcification depends on the hardness of your water.

- i** If you use an **external** CLARIS filter cartridge and this is activated, you will not be prompted to descale.

⚠ CAUTION

If the descaling agent comes into contact with the skin or eyes, this can cause irritation.

- ▶ Avoid contact with the skin or eyes.
- ▶ Rinse off the descaling agent with clean water. Should you get any descaling agent in your eye, see a doctor.

CAUTION

If the wrong descaling agent is used, the machine could be damaged and/or traces could be left behind in the water.

- ▶ Use only original JURA maintenance products.

CAUTION

If the descaling operation is interrupted, there may be damage to the machine.

- ▶ Allow the descaling programme to run to the end.

CAUTION

If the descaling agent comes into contact with sensitive surfaces (e.g. marble), damage cannot be ruled out.

- ▶ Clean up any splashes immediately.

- i** The descaling programme lasts approximately 50 minutes.

i JURA descaling tablets are available from specialised dealers.

Example: Proceed as follows to perform descaling when prompted to do so.

Precondition: **'Decalcify machine.'** and the symbol  are displayed.

P ▶ Press the P button.

'Maintenance status (1/5)'

▶ Press the **'Descale'** button.

▶ Press the **'Start'** button.

▶ Press the **'Start'** button again.

'Empty drip tray.'

▶ Empty the drip tray and coffee grounds container and put them back into the machine.

'Pour descaling agent into water tank.'

▶ Remove and empty the water tank.

▶ Completely dissolve 6 JURA descaling tablets in a receptacle holding 1000 ml of water. This may take several minutes.

▶ Pour the solution into the empty water tank and insert it into the machine.

'Press the Rotary Switch.'

▶ Place one receptacle under the dual spout and another under the hot-water spout.



▶ Press the Rotary Switch.

'Machine is being descaled.', water flows repeatedly out of the dual spout and the hot-water spout.

The operation stops automatically. **'Empty drip tray.'** appears on the display.

▶ Empty both receptacles.

▶ Empty the drip tray and coffee grounds container and put them back into the machine.

'Fill water tank.'

▶ Remove the water tank and rinse it thoroughly.

▶ Fill the water tank with fresh, cold water and reinsert the tank.

'Press the Rotary Switch.'

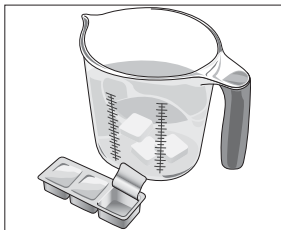

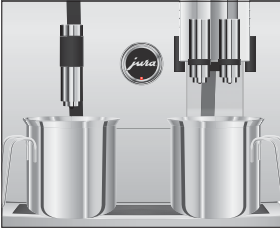

- ▶ Place the receptacles back under the dual spout and the hot-water spout.



- ▶ Press the Rotary Switch.

'Machine is being descaled.', water flows out of the dual spout and the hot-water spout.

The operation stops automatically. 'Empty drip tray.' appears on the display.

- ▶ Empty the drip tray and coffee grounds container and put them back into the machine.

'Descale' / 'Descaling complete.'

Descaling is now complete. Your GIGA is once more ready for use.



If the descaling operation stops unexpectedly, rinse the water tank thoroughly.

Cleaning the bean container

Coffee beans may be covered with a slight oil film which remains on the walls of the bean container. These traces may negatively affect the coffee result. For this reason clean the bean container from time to time.

Precondition: 'Fill bean container.' is displayed.



- ▶ Switch the machine off with the On/Off button.



- ▶ Switch the machine off at the power switch.

- ▶ Open the service cover on the back of the machine by pressing above the JURA logo.

- ▶ Push the **red** sliding catch completely to the rear to close the bean container.



- ▶ Turn the **blue** locking device outwards.

- ▶ Remove the bean container.

- ▶ Remove the aroma preservation cover.

- ▶ Empty the bean container.

- ▶ Clean the bean container with a soft, dry cloth.

- ▶ Fit the bean container.

5 Maintenance

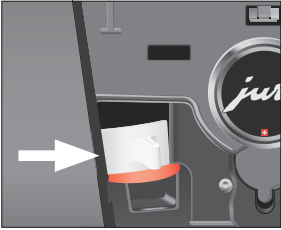

- ▶ Turn the blue locking device inwards.
- ▶ Pull the red sliding catch completely forwards.
- ▶ Refit the service cover and fix it by pressing above the JURA logo. It will click into place audibly.
- ▶ Fill the bean container with coffee beans and close the aroma preservation cover.

6 Display messages

| Message | Cause/Result | Action |
|--|---|--|
| 'Empty coffee grounds container.' | The coffee grounds container is full. You cannot prepare any products. | <ul style="list-style-type: none"> ▶ Empty the coffee grounds container and the drip tray (see Chapter 3 'Daily operation – Daily maintenance'). |
| 'Coffee grounds container not fitted.' | The coffee grounds container is not fitted. You cannot prepare any products. | <ul style="list-style-type: none"> ▶ Fit the coffee grounds container. |
| 'Empty drip tray.' | The drip tray is full. You cannot prepare any products. | <ul style="list-style-type: none"> ▶ Empty the drip tray. ▶ Clean and dry the metal contacts on the back of the drip tray. |
| 'Drip tray not fitted.' | The drip tray is not inserted correctly or is not inserted at all. You cannot prepare any products. | <ul style="list-style-type: none"> ▶ Fit the drip tray. |
| 'Press the Rotary Switch.' | The system must be filled with water or the GIGA prompts you to continue a started maintenance programme. | <ul style="list-style-type: none"> ▶ Turn the Rotary Switch to continue with the maintenance programme or to fill the system. |
| 'Fill bean container.' | The bean container is empty. You cannot prepare any speciality coffees, but you can prepare hot water and milk. | <ul style="list-style-type: none"> ▶ Fill the bean container (see Chapter 1 'Preparing and using for the first time – Filling the bean container'). |
| 'Rinse the milk system.' | The GIGA is prompting you to rinse the milk system. | <ul style="list-style-type: none"> ▶ Press the P button and then the 'Rinse the milk system' button to initiate milk system rinsing. |
| 'Clean machine.' | The GIGA is prompting you to clean it. | <ul style="list-style-type: none"> ▶ Perform cleaning (see Chapter 5 'Maintenance – Cleaning the machine'). |
| 'Decalcify machine.' | The GIGA is prompting you to descale it. | <ul style="list-style-type: none"> ▶ Perform descaling (see Chapter 5 'Maintenance – Descaling the machine'). |
| 'Change filter.' | After the set amount of water has flowed through the external filter cartridge, it will cease to work. The GIGA is prompting a filter change. | <ul style="list-style-type: none"> ▶ Replace the external filter cartridge (see Chapter 5 'Maintenance – Changing the filter'). |

6 Display messages

| Message | Cause/Result | Action |
|-----------------------------|---|---|
| 'Spout is not fitted.' | The dual spout or the cover of the dual spout is not fitted correctly. | ► Fit the cover of the dual spout or the dual spout correctly. |
| 'Not enough ground coffee.' | There is insufficient ground coffee in the machine; the GIGA stops the operation. | ► The next time you prepare a beverage, add more ground coffee (see Chapter 2 'Preparation – Ground coffee'). |

7 Troubleshooting

| Problem | Cause/Result | Action |
|---|--|--|
| Insufficient foam is produced when the milk is frothed, or milk sprays from the dual spout. | The dual spout is dirty. | ► Rinse and clean the dual spout (see Chapter 5 'Maintenance – Cleaning the milk system'). |
| Coffee only comes out in drips when it is being prepared. | Coffee or ground coffee has been ground too finely and is blocking the system. The same filter cartridge may have been used several times or the water hardness set incorrectly in the programming mode. | ► Put the grinder on a coarser setting or use coarser ground coffee (see Chapter 4 'Permanent settings in programming mode – Setting the consistency of grind'). ► Perform descaling (see Chapter 5 'Maintenance – Descaling the machine'). |
| 'Fill bean container.' is not displayed although the bean container is empty. | The bean monitor is dirty. | ► Clean the bean container (see Chapter 5 'Maintenance – Cleaning the bean container'). |
| 'Empty drip tray.' is always displayed. | The metal contacts of the drip tray are dirty or wet. | ► Clean and dry the metal contacts on the back of the drip tray. |
| 'Error 2' is displayed. | If the machine was exposed to the cold for a long period of time, heating is disabled for safety reasons. | ► Warm the machine at room temperature. |
| Other 'Error' messages are displayed. | – | ► Switch the GIGA off at the power switch. Contact customer support in your country (see Chapter 11 'JURA contact details / Legal information'). |

- i** If you were unable to solve the problem, contact customer support in your country (see Chapter 11 'JURA contact details / Legal information').

8 Transport and environmentally friendly disposal

Transport / Emptying the system

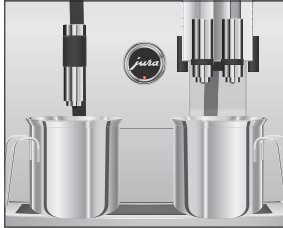

In order to protect the GIGA from frost during transport, the system must be emptied.

Precondition: 'Please select product:' is displayed.

- ▶ Place one receptacle under the dual spout and another under the hot-water spout.
- P ▶ Press the P button.
'Maintenance status (1/5)'
- ⊙ ▶ Turn the Rotary Switch until the programme item 'Machine settings (3/5)' is displayed.
- ▶ Press the 'Factory setting' button.
'Factory setting'
- ▶ Press the 'Empty system' button.
'Press the Rotary Switch.'
- ⊙ ▶ Press the Rotary Switch.
'System is emptying.', water flows out of the dual spout and the hot-water spout.
The operation stops automatically. Your GIGA is switched off.

Disposal

Please dispose of old machines in an environmentally neutral way.



Old machines contain valuable, recyclable materials which should be recycled. Please therefore dispose of old machines via suitable collection systems.

9 Technical data

| | |
|--|---|
| Voltage | 220–240 V ~, 50 Hz |
| Power | 2300 W |
| Airborne noise emitted | $L_P < 70$ dB (A) |
| Ambient conditions | Humidity max. 80% Ambient temperature 10–35 °C |
| Conformity mark | CE |
| Energy consumption 'Save energy' / 'Save No' | approx. 30 Wh |
| Energy consumption 'Save energy' / 'Save Level 1' | approx. 12 Wh |
| Energy consumption 'Save energy' / 'Save Level 2' | approx. 15 Wh |
| Pump pressure | static, max. 15 bar |
| Inlet pressure | max. 0.6 MPa |
| Holding capacity of water tank | 2.6 l |
| Holding capacity of bean container | 1000 g |
| Holding capacity of coffee grounds container | max. 40 portions |
| Cable length | approx. 1.1 m |
| Weight | approx. 22 kg |
| Dimensions (W × H × D) | 32 × 55 × 49.7 cm |

Technical data for permanent water connection:

| | |
|----------------------------|--|
| Permanent water connection | G 3/4" external thread |
| Water supply line | Metal hose with G 3/4" union nut (hose must comply with the applicable regulations for your country) |
| Shut-off valve | with non-return valve (type EA) and filter |

Information for testers (repeat test in accordance with DIN VDE 0701-0702): The central grounding point (CGP) is located on the front of the machine below the JURA logo (turn JURA logo anti-clockwise).

10 Index

A

- Adding products to the start screen 28
- Addresses 60
- Adjusting the product settings 25
- Aroma preservation cover
 - Bean container with aroma preservation cover 4
- Automatic switch-off 33, 34
- Automatic switch-on 33

B

- Background 37
- Barista recipes 19
 - Deactivating 37
 - Preparation 20
 - Programming mode 37
- Bean container
 - Bean container with aroma preservation cover 4
 - Cleaning 47
 - Filling 10
- Bus bar
 - Technical data 53
- Button
 - On/Off button 5
 - P button (programming) 5

C

- Cappuccino 16
- Cappuccino frother cleaning
 - Cleaning the milk system 40
- Cappuccino frother rinsing
 - Rinsing the milk system 39
- Changing a name 27
- Changing the product assigned to a button 28
- CLARIS filter cartridge
 - Changing 43
- Classics 25
- Cleaning
 - Bean container 47
 - Machine 44
- Coffee 16
- Coffee à la carte 16
- Coffee grounds container 4
- Consistency of grind
 - Setting the consistency of grind 29

- Contact details 60
- Cover
 - Service cover 5
 - Storage compartment 4
 - Water tank 4
- Cup grille 4
- Customer support 60

D

- Date 32
- Descaling
 - Machine 45
- Display 5
- Display messages 49
- Display settings 36, 37
- Disposal 52
- Double product 17
- Drip tray 4
- Dual spout
 - Dismantling and cleaning 41
 - Height- and width-adjustable dual spout 4

E

- Emptying the system 52
- Energy-saving mode 31
- Errors
 - Troubleshooting 51
- Espresso 16
- Expert mode 25

F

- Factory settings
 - Restore factory settings 35
- Filler funnel
 - Filler funnel for ground coffee 4
- Filling
 - Bean container 10
- Filter
 - Changing 43
- First-time use 11

G

- Grinder
 - Setting the consistency of grind 29
- Ground coffee 18
 - Measuring spoon for ground coffee 4

H

- Hotline 60
- Hot water 21
- Hot-water spout
 - Height-adjustable hot-water spout 4

I

- Instant coffee
 - Ground coffee 18
- Internet 10

J

- JURA
 - Contact details 60
 - Internet 10

L

- Language 36
- Latte macchiato 16
- Locking device 5

M

- Machine
 - Cleaning 44
 - Descaling 45
 - Regular maintenance 23
 - Rinsing the coffee system 39
 - Setting up 10
 - Switching off 23
 - Switching on 22
- Mains cable 4
- Maintenance 39
 - Daily maintenance 22
 - Regular maintenance 23
- Maintenance settings 30
- Measuring spoon for ground coffee 4
- Messages, display 49
- Milk
 - Connecting milk 15
- Milk system
 - Cleaning 40
 - Rinsing 39

P

- Permanently setting amounts for the cup size 20
- Permanent settings in programming mode 24

Power switch 4

Preparation 16

- At the touch of a button 17
- Barista recipes 20
- Cappuccino 16
- Coffee 16
- Espresso 16
- Ground coffee 18
- Hot water 21
- Latte macchiato 16
- Ristretto 16
- Two speciality coffees 17
- Using the product selector 18

Preparation options 16

- At the touch of a button 17
- Using the product selector 18

Problems

Troubleshooting 51

Product selector 16, 18

Product settings 25

Adjusting 25

Programming mode 24

Adding products to the start screen 28

Automatic switch-off 34

Background 37

Barista recipes 37

Display settings 36

Energy-saving mode 31

Language 36

Maintenance settings 30

Product settings 25

Querying information 38

Renaming a product 27

Restore factory settings 35

Setting the consistency of grind 29

Setting the water hardness 31

Time and date 32

Timer 33

Units 35

Proper use 6

Q

Querying information 38

Quick installation 12

R

- Recipes
 - Barista recipes 19
- Regular maintenance 23
- Renaming a product 27
- Rinsing the coffee system 39
- Ristretto 16
- Rotary Selection 16
 - Product selector 18
- Rotary Switch 5

S

- Safety 6
- Safety information 6
- Service cover 5
- Service socket 5
- Settings
 - Maintenance settings 30
 - Permanent settings in programming mode 24
- Setting up
 - Setting up the machine 10
- Sliding catch 5
- Splash guard 4
- Spout
 - Height-adjustable hot-water spout 4
 - Height- and width-adjustable dual spout 4
- Switching off
 - Machine 23
- Switching on
 - Machine 22
- Switch-off
 - Automatic switch-off 33, 34
- Switch-off time 33
- Switch-on
 - Automatic switch-on 33
- Switch-on time 33
- Symbol description 3

T

- Technical data 53
- Tel 60
- Time 32
- Time format
 - Programming mode 35
- Timer 33
- Transport 52
- Troubleshooting 51
- Two products 17

U

- Units 35
- Use, First-time 11

V

- Ventilation slats 4

W

- Water hardness
 - Determining the water hardness 15
 - Setting the water hardness 31
- Water tank 4
- Website 10

11 JURA contact details / Legal information

Your JURA service partner

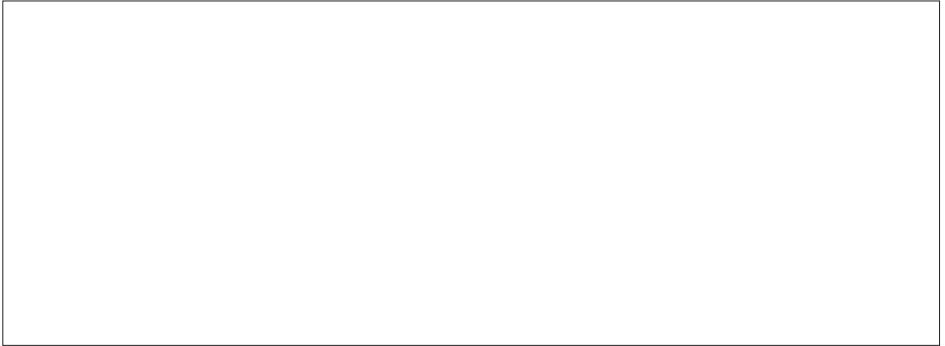

JURA Elektroapparate AG
Kaffeeweltstrasse 10
CH-4626 Niederbuchsiten
Tel. +41 (0)62 38 98 233
www.jura.com

- Directives** The machine complies with the following directives:
- 2006/42/EC – Machinery Directive
 - 2004/108/EC – Electromagnetic Compatibility
 - 2009/125/EC – Ecodesign Directive
 - 2011/65/EU – RoHS Directive

Technical changes We reserve the right to make technical changes. The diagrams used in these instructions for use are for illustration purposes only and do not represent the original colours of the machine. Some details of your GIGA may vary.

Feedback Your opinion is important to us!
Use the contact details at www.jura.com.

Copyright The instructions for use contain information which is protected by copyright. It is not permitted to photocopy these instructions for use or translate them into another language without the prior written consent of JURA Elektroapparate AG.