



B L A Z E R U S E R M A N U A L

READ THIS MANUAL CAREFULLY BEFORE USE – FAILURE TO DO SO MAY RESULT IN INJURY, PROPERTY DAMAGE AND MAY VOID WARRANTY.

KEEP THIS MANUAL FOR FUTURE REFERENCE.

PRODUCTS COVERED BY THIS MANUAL MAY VARY IN APPEARANCE, ASSEMBLY, INCLUSIONS, SPECIFICATIONS, DESCRIPTION AND PACKAGING.

CONTENTS

Safety & Warning	1
Introduction	3
Assembly Instructions	5
● Rear Shock Absorber Installation	6
● Frame Installation	6
● Rear Fenders Installation	7
● Rear Wheels Installation	7
● Rear Brake Installation	8
● Handlebar Installation	8
● Front Fender Installation	10
● Front Wheel Installation	10
● Front Basket and Headlight Installation	12
● Chain Installation	13
● Derailleur Installation	14
● Tail Light Installation	15
● Rear Basket Installation	15
● Saddle Installation	16
● Pedal Set Installation	17
● Battery Installation	17
● Battery Charging	18
● Serial Number Record	20
Riding Instructions	30
Using Gears	31
Using Brakes	32
Guidelines for Using Brakes	32
Tyre Pressures	33
Troubleshooting	36
12 Month Limited Warranty	39

Safety & Warning

- Riding can be a hazardous activity. Certain conditions may cause the equipment to fail without fault of the manufacturer. The product can and is intended to move, and it is therefore possible to lose control, fall-off and/or get into dangerous situations that no amount of care, instruction or expertise can eliminate. If such things occur, you can be seriously injured or die, even when using safety equipment and other precautions. RIDE AT YOUR OWN RISK AND USE COMMON-SENSE. FAILURE TO USE COMMON- SENSE AND HEED ALL SAFETY WARNINGS AND RECOMMENDATIONS INCREASES RISK OF INJURY. USE THE PRODUCT ONLY WITH APPROPRIATE CAUTION AND SERIOUS ATTENTION TO SAFE OPERATION.
- Before riding on the road, take time riding in an enclosed area to familiarize yourself with the controls and behaviors of an electrically assisted bicycle. Try all settings so you are familiar with the results.
- Before every ride, check bicycle condition and ensure that no fasteners are loose, particularly axles, pedals, seat and handlebars. Ensure that the tyres are inflated to within specification (printed on the tire sidewall), and that the brakes are operating correctly.
- Maximum load capacity = 330lbs.
- Understand and obey any local laws or regulations which may affect locations where the product may be used. Ride defensively.
- This product is manufactured for performance and durability but is not impervious to damage. Stunts or other aggressive riding can over-stress and damage the product, and the rider assumes all risks associated with how the product is looked after.
- Keep fingers and other body parts away from moving components.
- Always wear suitable protective equipment, such as an approved safety helmet (with chin strap securely buckled). A helmet may be legally required by local law or regulation in your area. Wear suitable footwear for bicycle riding and clothing that helps make you visible to others.
- Please read this instruction manual carefully before you ride the electric bike for the first time.
- Please always check the brakes prior to riding to make sure they are working correctly. Adjust the brake sensitivity if needed. Only ride at a speed that the conditions permit, for example, slow down on snowy or rainy days.
- Always hold the handlebars with both hands, except when you need to notify others you are turning.
- Use a light at night, or when visibility is not good. If you are not able to see clearly with a light, do not attempt to ride your bike.
- Make sure your body and other objects do not come into contact with the chain or the wheels whilst they are moving.
- Never touch the charging connector on the battery case with your hands when they are wet, or with keys or other metallic objects, in case they damage the battery pole and cause a short circuit.
- Wear bright clothing to help make you visible to others when you are riding at night.
- Don't lend the electric bicycle to anyone who doesn't know how to operate it, or who haven't read the manual.
- Like other cycles, it can only carry one person, carrying a passenger is not permitted.

- To brake, the rider must action both brake levers to the correct degree.
- Never ride the electric bike under the influence of drugs or alcohol.
- Do not ride under bad conditions, such as on uneven, wet or loose surfaces.
- If possible, do not ride in adverse weather conditions, low visibility or if you are very tired.
- This electric bicycle can be used in the rain; however, it must not be submerged in water or puddles. The controller, motor and other electrical devices may be short-circuited, causing damage and creating possible dangerous situations.
- Never spray your bike directly and don't get the electrical components wet (the battery connector, motor, controller, cables, handlebar controls, etc)
- Don't let children under the age of 18 ride the bike.
- ONLY use the charger which was provided (never use a charger from a different model).
- The charger is designed for indoor use only. Keep the charger away from water to avoid short circuit. Don't even use it in a dampening, combustible or explosive environment. Do not remove the plug by pulling the cord, always grip the charging port by its metal body.
- Never modify the electrical system. Alterations could cause a fire resulting in serious injury and could also damage the electrical system.
- Ensure the voltage and frequency of the charger is compatible with mains electrical supply.
- Use the battery charger in dry locations only.
- Regularly check the charger for damage to the electrical cord, plug, enclosure and other parts. If any damage or malfunction occurs, do NOT use the charger until repaired or replaced.
- Do not operate the charger or charge batteries near flammable materials.
- Do not clean or perform any maintenance on the product when it is being charged.

Introduction

Congratulations on purchasing a DWMEIGI pedal assisted bicycle. We hope you enjoy years of satisfactory and safe riding.

Read the manual

This manual is provided to help you to get the best performance, comfort, enjoyment and safety from your bicycle. The manual describes specific care and maintenance procedures that help protect your warranty and ensure trouble-free use. Please pay particular attention to the section on battery charging and maintenance.

Read the manual before assembling and riding your bicycle.

Note that the manual is not intended to be an extensive reference source for servicing, maintenance and/or repairs. For additional assistance, contact an authorized DWMEIGI service centre.

In the interests of your safety and the safety of others, it is highly recommended to have your bicycle assembled and serviced / adjusted by a skilled bicycle mechanic.

Installation Video Guide is available at <https://youtu.be/grUvJ1tQVQE&t>

Operation

Before riding, ensure that all required fasteners are tightened to the correct torque and charge the battery prior to use.

Always wear a helmet and appropriate safety equipment and always keep both hands on the handlebars and both feet on the pedals whilst riding. Read, understand and follow all safety recommendations before riding. Avoid riding in damp conditions, rain etc as this may affect operation or possibly damage the bicycle electronics.

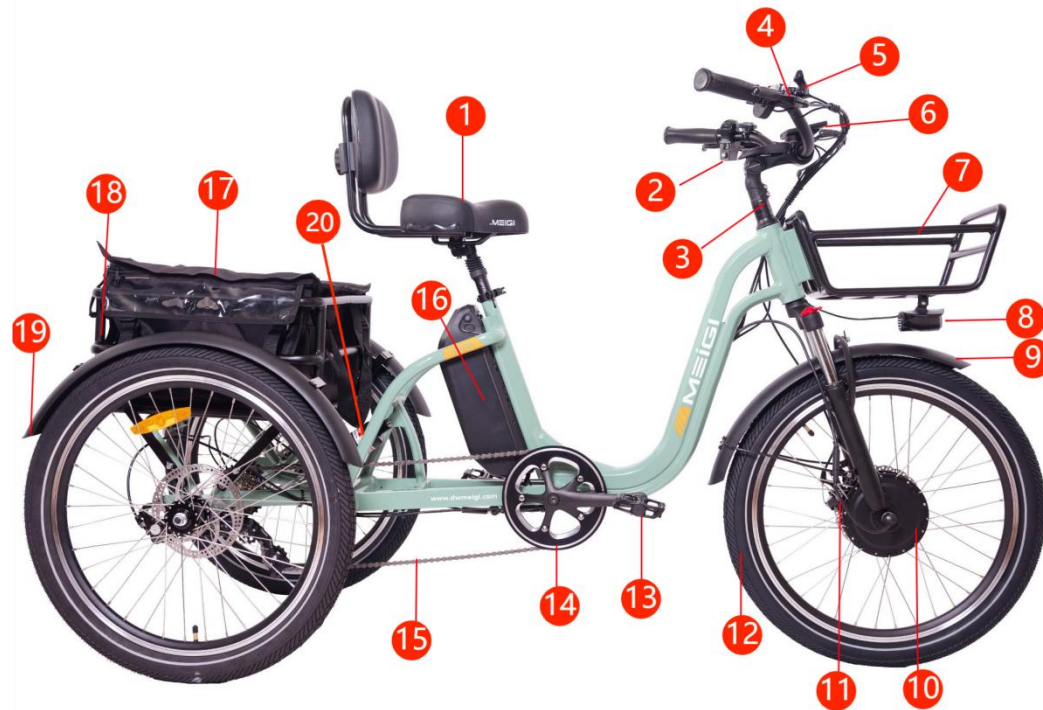

No.	Name	No.	Name
1	Saddle	11	Disc Brake
2	Reverse&Turning Signal&Horn Button	12	Tires
3	Stem	13	Pedal Set
4	Parking Brake Lever	14	Chain Wheel
5	Transmission Shifter	15	Chain
6	Display	16	Battery
7	Front Basket	17	Rear Bag
8	Headlight	18	Rear Basket
9	Front Wheel Fender	19	Rear Wheel Fender
10	Motor	20	Rear Shock Absorber

Assembly Instructions

Before you start to assemble the tricycle, please check carefully if you received all parts.



No.	Name
1	Front and Rear Wheels
2	3 Fenders
3	Frame Section
4	Battery
5	Front Basket
6	Backrest Saddle
7	Rear Basket & Rear Bag
8	MEIGI Hardware Bag

- **Rear Shock Absorber Installation**

Step 1: Remove the 2 bolts, connect the absorber on the rear frame, then fasten the 2 bolts.

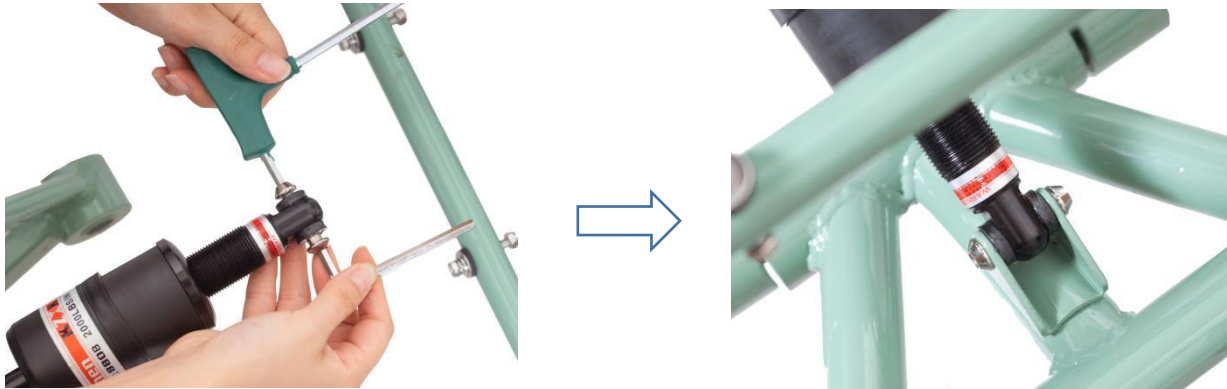

- **Frame Installation**

Step 1: Remove one side screw and spacer from the frame axle, insert the axle into the rear frame and front frame, place the spacer and screw into the hole on the axle, then fasten the two side screws with the allen wrench.



- **Rear Fenders Installation**

Step 1: Remove the 4 bolts, then lock the fender bracket on the frame with 4 bolts.

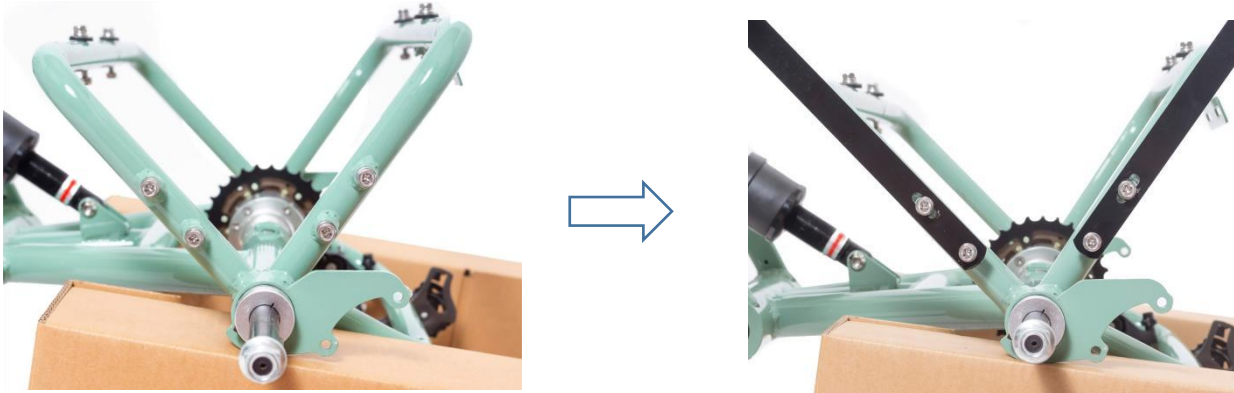

- **Rear Wheels Installation**

Step 1: Confirm the two rear wheels left and right, the tire pattern is forward, the disc rotor is inside.

Step 2: Remove nuts from rear wheel axle, put a wheel on the axle - the axle pin go through the wheel flute. Tighten the nuts.

To attach the opposite wheel repeat above steps.



- **Rear Brake Installation**

Step 1: Remove the two bolts from the disc caliper, assemble the disc caliper - make sure the rotor slide through the disc brake pads. Tighten the two bolts.

To attach the opposite brake repeat above steps.

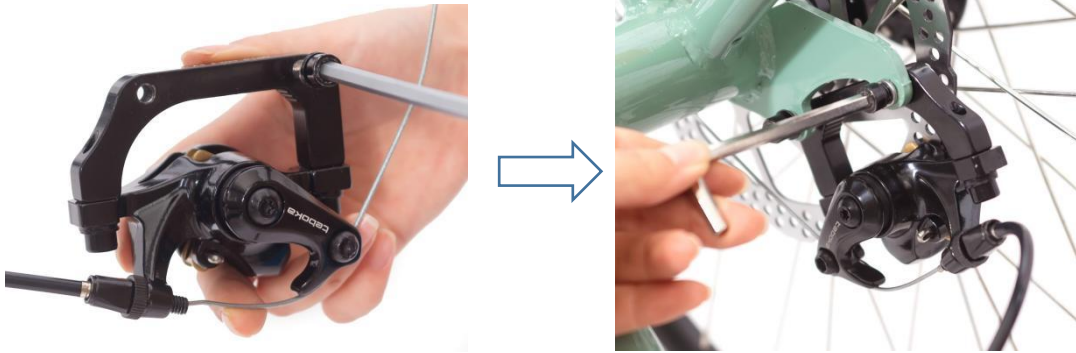

- **Handlebar Installation**

Step 1: Turn the front fork to face forward.

Step 2: Remove the protective parts.



Step 3: Release the two stem bolts to put the stem on the front fork. Push the stem safety clasp and open the quick-release lever, then release the adjusting bolt to drop the handlebar and expose the stem binder bolt at the top of the stem post.



Step 4: Tighten the stem binder bolt at the top of the stem post. Then adjust the handlebar to the comfortable angle and tighten the adjuster bolt to be sure the handlebar are clamped in place, close the quick-release lever. Lastly, tighten the two stem bolts.



- **Front Fender Installation**

Step 1: Attach the front fender, ensure the fender bracket is on the outside of the fork branch.



- **Front Wheel Installation**

Step 1: Remove the protective axle and plate.



Step 2: Insert the disc rotor into the brake caliper, and put it between the brake pads. Put the motor wheel on the fork with a correct direction. Check the photos below, the washers ② on the axle has a standard sequence.

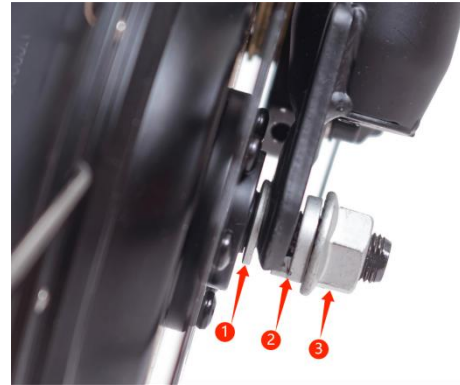

Step 3: Tighten each nut by #19 Wrench until both are firmly set. Push the caps onto each end of the axles.



Step 4: Connect the motor wire. Check carefully the 2 arrows on the motor wire plug. Turn clockwise the metal hoop if need. Use a tie-wrap to fasten the motor wire.

Note: ARROW TO ARROW is a very important point when you connect the plug.

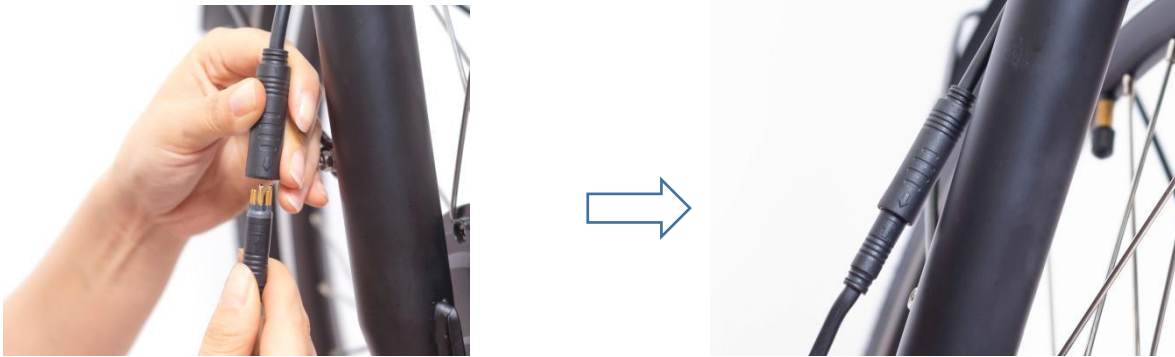

● Front Basket and Headlight Installation

Step 1: Release the 4 screws, take away the protective board.

Step 2: Lock the basket on the head tube, screw holes to holes, use 4mm allen wrench to tighten them in “x” way.

Step 3: Attach the headlight under the front basket.



- **Chain Installation**

Step 1: Thread the chain through the derailleur, freewheel, frame and chainwheel.

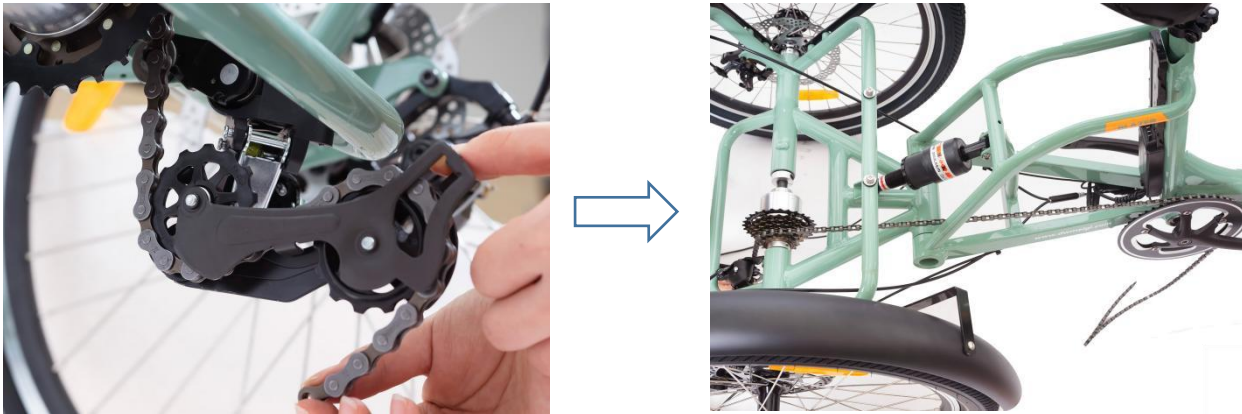

Step 2: Take out the chain buckles from the hardware bag. Connect the chain with buckles.



- **Derailleur Installation**

Step 1: Change the shifter to 7 level.



Step 2: Let the transmission cable through the derailleur, use #9 wrench to tighten the nut. Use a cable cap to protect wire.



- **Tail Light Installation**

Step 1: Release the screws from the tail light, and put the light on the tail light clamp. Then use the screwdriver to tighten it.

Don't forget to tie the cables on the frame.

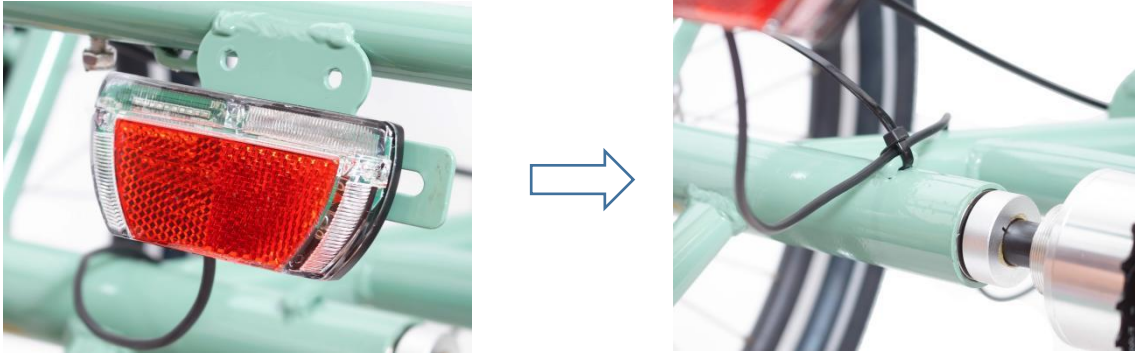

- **Rear Basket Installation**

Step 1: Use the tools to release the 4 bolts&nuts , and put the rear basket on it ,holes to holes. Then tighten the bolts and nuts.

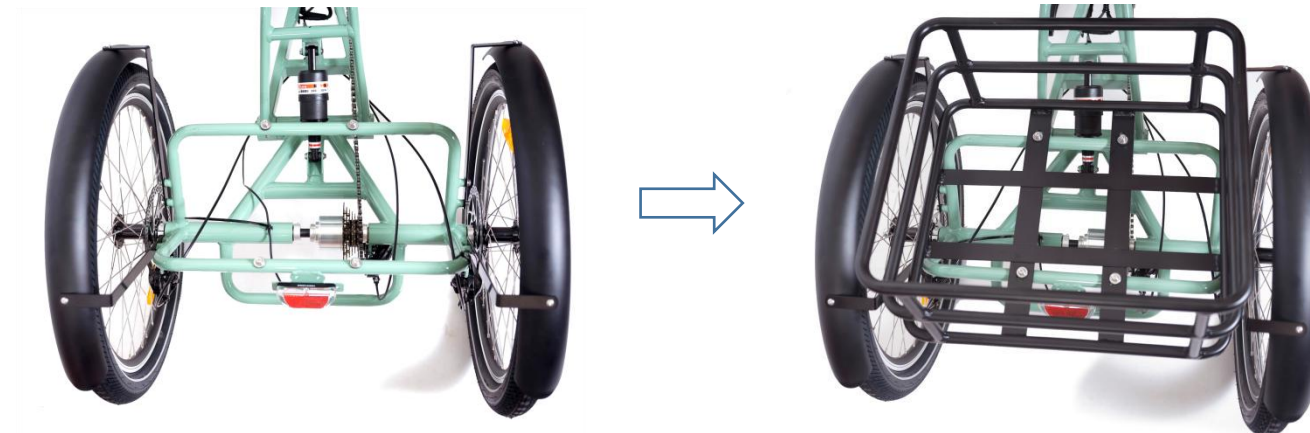

- **Saddle Installation**

Step 1: Install the saddle on the seat post. Release the clamp and adjust the quick release to the correct position.



Step 2: Insert the seat post into the seat tube, and adjust the height you need. Then lock the clamp by hand. The backrest is adjustable.

Note: There's min insert line on the seat post, it must keep in the frame tube.



- **Pedal Set Installation**

Step 1: Check the side mark on the pedal set. "L"= Left, "R"=Right. Match the pedal marked **R** with the right-hand crank arm and match the pedal marked **L** with the left-hand crank arm.

Step 2: Carefully thread the pedal into crank by hand and then tighten it by #15 wrench.

Note: Left side pedal is counterclockwise rotation, Right side pedal is clockwise rotation.



- **Battery Installation**

Step 1: Confirm the numbers on the battery and keys are the same. Insert the battery into the front frame. Then turn the key clockwise to lock position to lock the battery.



- **Battery Charging**

Must turn the power switch to “OFF” and pull out the key before charge the battery. Keep the charger and battery in a dry and ventilated condition.



- **Firstly, connect the output plug of the charger with the socket of the battery case properly, and then insert the input plug into the electrical outlet. The charger light will turn on, red light means charging, green light means fully charged.**
- **When the light turns from Red to Green**, it means the battery has been fully charged. Usually, it will take about 4-6 hours to recharge the battery depending on the batteries state of charge. However, it's a good idea to let it charge for an additional 2 hours after the light has turned green if it's convenient for you, as it will extend the service life of the battery.
- Do not charge the battery for more than 10 hours to avoid overcharging and damaging the battery. After the light turns GREEN, the charger is in the state of trickle electric current and will fill slowly to attempt to maintain the state of charge. If you are going to be out for a long time, you should disconnect the charger, especially in hot weather.
- The charger will become warm during charging, so keep the charger away from any heat sources. Please always keep the charger dry and clean. The electronics inside contain high voltages, so never disassemble the charger by yourself.
- After charging, please pull the input plug out of the electrical outlet first, and then pull out the output connecting a plug from the battery case. Do not let the charger charge the battery or be left connected for a long time, as it may damage the charger and cause a fire.
- While charging, please keep it the charger and battery out of the reach of children. Do not put anything on top of the charger when use, and prevent any liquid, metal or metal fillings from coming into contact with the charger.
- You can also remove the battery from the bicycle and then charge it. You should lift the saddle with the lever that is underneath it, which will enable you to remove the battery. Before you do this, you will have to unlock the battery with the ignition key. When you finish charging, replace the battery. To replace the battery, insert the battery along with the slide bracket and then lock the battery with the ignition key.

- Do not touch the two poles in the battery case with your hands when the battery is removed for charging. The charging connector poles cannot be touched with any metal or any other material that conducts electricity, otherwise, it may cause a short circuit.
- If you don't ride your bike for a long time, the battery should be charged at least one time per month. This will ensure the battery life. DO NOT use in the state of low battery capacity. Do not leave your battery in a fully discharged state for long periods of time. The battery will continue to self-discharge, resulting in damage.
- Avoid any contact with water when charging your battery. If a plug or socket gets wet, dry it completely before using.
- When charging, if there is a peculiar smell or the temperature is extremely high, please stop charging immediately and contact us.

● **Serial Number Record**

Please record the frame, motor and battery serial number. That's a important information for the warranty service.



FRAME NUMBER: _____

MOTOR NUMBER: _____

BATTERY NUMBER: _____

Presentation of LCD Screen



Specifications of LCD Display

Rated voltage: 48V

Rated working current: 10mA

Maximum working current: 30mA

Off-state leakage current: <1uA

Operating temperature: -20°C~ 60°C

Store temperature: -30°C~ 70°C

Function summary and layout

◆ Function summary

KD51C has many functions to meet the riders' needs. The indicating elements are as follows:

- Smart battery indication
- Assist level
- Speed indication (incl. Current speed, max. speed and avg. speed)
- ODO and trip
- The push-assistance function
- Trip time
- The lighting On/Off
- Error code indication
- Motor power
- Range
- Various parameters settings (e.g., wheel size, speed-limited, battery level bar, Assist level, controller limited current, max speed, password enable, etc.)
- Recover default settings

◆ Function Layout

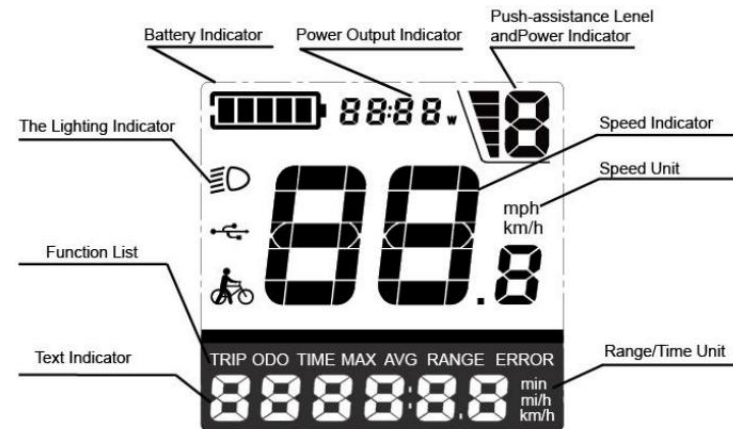

Functional Area Distribution

General Operation

To switch on the E-bike system and provide the power supply to the controller, hold the On/Off button on the remote for 1 second.

To switch off the E-bike system, hold the On/Off button for 2s. The E-bike system no longer uses the battery power.

When E-bike system is switched off, the leakage current is less than 1 μ A.

When the E-bike is parked for approx. 10 minutes, the E-bike system switches off automatically.

◆ Display Interface

After switching on the E-bike system, the display will show Current Speed and TRIP by default.

Press “i” button on the remote to switch between the indication functions below:

Trip Distance (Km)→ODO (Km)→Trip Time (min)→Max. Speed (Km/h) → Avg. Speed (Km/h) → RANGE (Km)

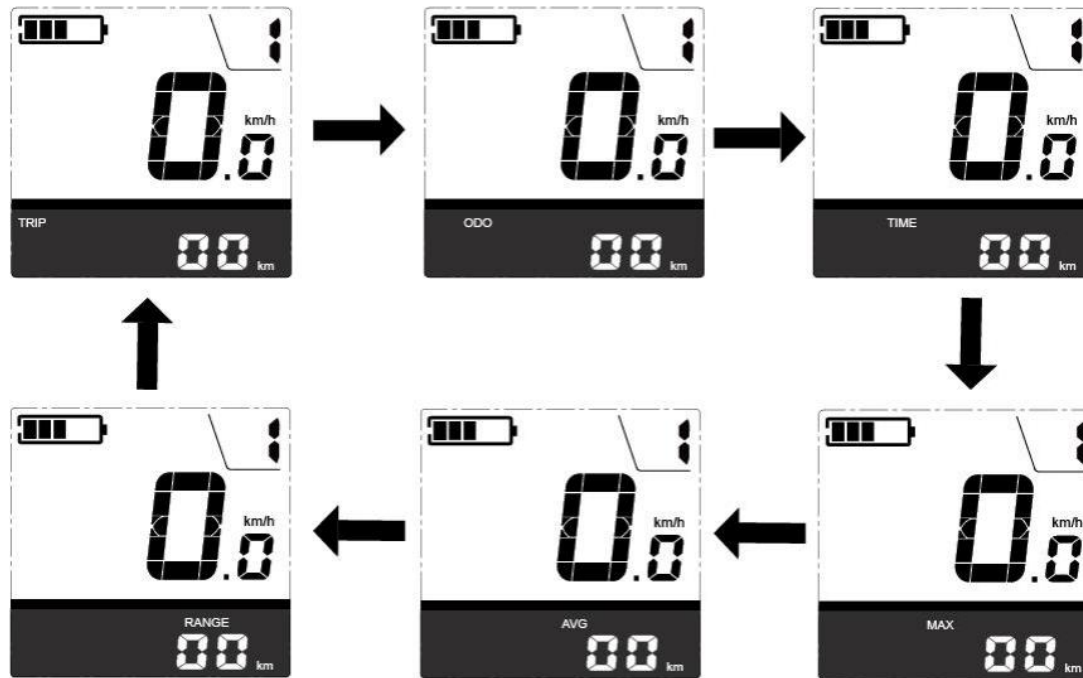

Display interface

◆ Switching Push-assistance Mode On/Off

To activate the push-assistance function, press and hold the “-” button on the remote.

After 2 seconds, the E-bike is activated to go at a uniform speed of 6 Km/h while the screen shows ‘’: The push-assistance function is switched off as soon as you release the “-” button .

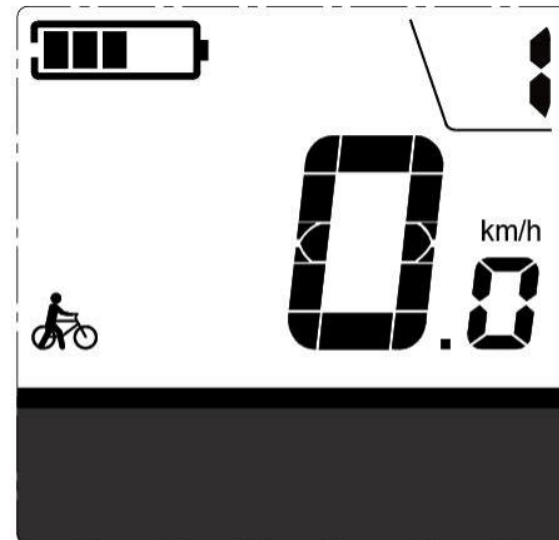



Push-assistance function may only be used when pushing the E-bike. Be aware of danger of injury when the wheels of the E-bike do not have ground contact while using the push-assistance function.

◆ Switching the Lighting On/Off

To switch on E-bike front light or rear light, briefly press the “” button on the remote. The display backlight brightness is automatically reduced while the screen displays .

Likewise, briefly press the “” button again, the bike front light or rear light can be switched off and display backlight recover its brightness.

*If E-bike front light or rear light is independent of “” button, the “” button can only be used to switch on/off the display backlight.

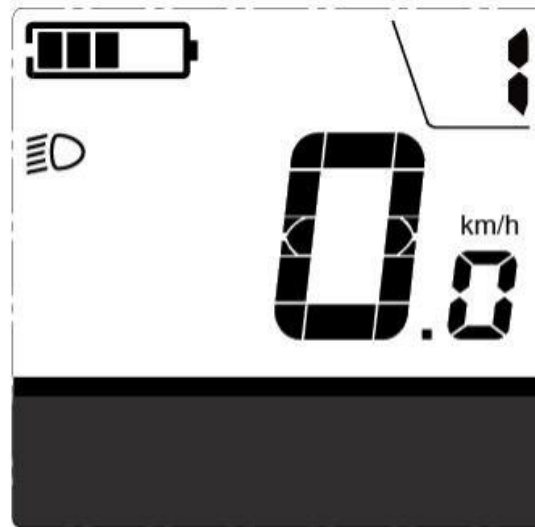

Switch the Lighting On/Off Interface

Assist Level Options

The assist level of the E-bike drive can be changed anytime, even during riding. The assist level ranges from 0 to 9 (level 0 to level 9). The default assist level is “1” when the display is started. The output power is zero on Level “0”. Level “1” is the minimum output power. Level “9” is the maximum output power.

Press +/- button on the remote to switch between the E-bike system assist levels and change the motor output power.

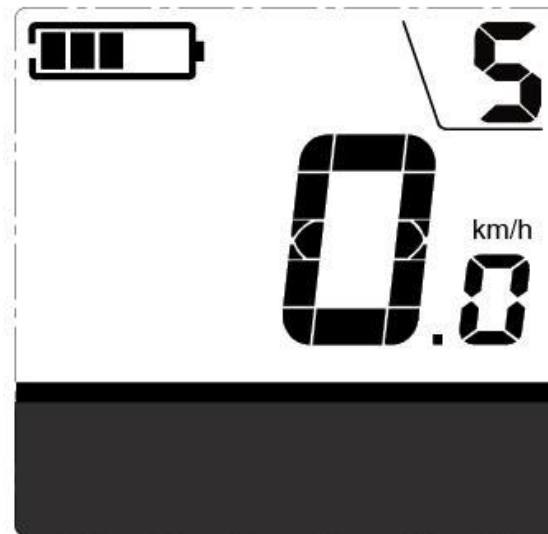

Assist Level “5”

◆ Battery Indicator

The five battery bars represent the capacity of the battery. Each bar is equivalent to a capacity of approx. 20%. The five battery bars are bright when the battery is in full voltage.

When the battery is in low voltage, battery frame will flash to give a notice that the battery needs to be recharged immediately.



Battery Indicator

◆ Motor Power Indicator

The power of the motor can be read via below interface.

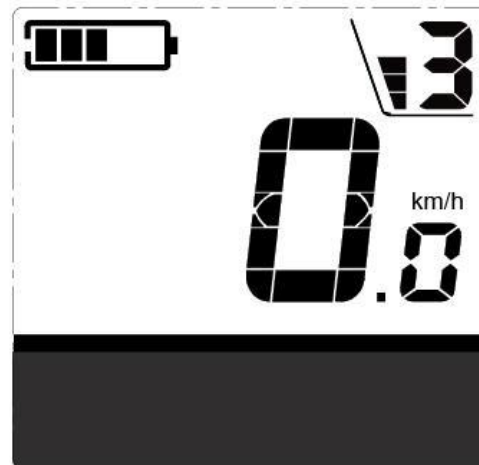

Motor Power Indication

◆ **Error Code Indication**

The components of the E-bike system are continuously and automatically monitored. When an error is detected, the respective error code is indicated in text indication area.

Refer to the detail message of the error codes in **Attached list 1**.

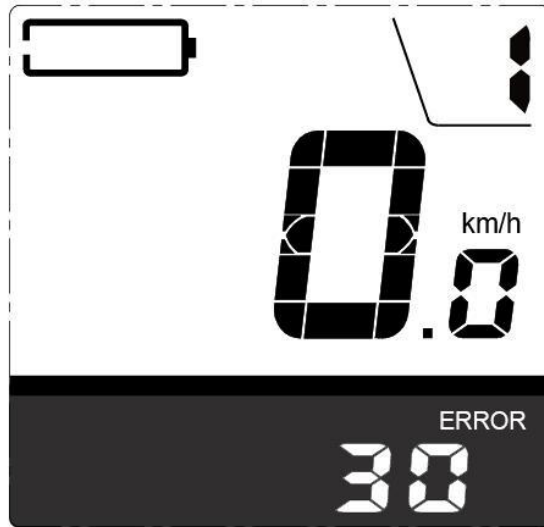

Error Code Indication

Error Code	Definition
21	Current Abnormality
22	Throttle Abnormality
23	Motor Phase Abnormality
24	Motor Hall Signal Abnormality
25	Brake Abnormality
30	Communication Abnormality

Attached List 1

■ **Have the display inspected and repaired when an error code appears. Or else, you will not be able to ride the bike normally. Please always refer to an authorized bicycle dealer.**

Regarding the general settings, like distance clearance, backlight settings, speed limit settings, personalized parameter settings, please download the display user guide by visiting www.dwmeigi.com

Riding Instructions

Check before riding it for the first time:

The bicycle was assembled and checked before leaving the factory, nevertheless, before using for the first time, check the unit thoroughly.

- First, check to see whether the battery is fully charged and locked.
- Check the air pressure of the tires is normal
- Check and make sure the front and rear brakes are working properly
- Check the tightness of the front and rear wheels
- Check and make sure the handlebar and saddle are fastened tightly enough. Make sure the quick releases are locked and all lock nuts and screws are tightened.

Riding:

Turn on the power switch (turn the ignition key to " ON" position), the power display indicator will light on, indicating the unit is powered.

Just like riding a normal bicycle, seat yourself on the saddle. Put one foot on the pedal and do a final check to see that everything is okay and working well, especially the breaks. Start pedaling, and when you reach a certain speed, the motor will automatically be activated and start to move your bike. To stop the bicycle motor, just stop pedaling and the motor will stop automatically. To bring the vehicle to a halt, use the brake.

The brake will trigger the motor to stop. If either of the brake levers are pulled, the power will be cut off automatically and the motor will not work.

Battery level gauge:

When the battery is getting low, you will see it on the LCD display, as the battery indicator empties. When this occurs, turn OFF the power switch and only use the pedals to ride, without the assistance of the motor. You will have to charge the battery when you get to an electrical outlet and will be able to use the electric motor again once the unit is fully charged.

Parking:

Shut the power "OFF" and pull out the key of the battery case while parking. The power switch should be turned "OFF" when pushing so that you don't start up the motor by accident. Use a chain lock to further secure your bicycle when necessary.

Note: Don't expose the e-bike to sunlight or rain for a long time, or some electrical components may behave abnormally.

Note: If you use the brakes frequently, turn the bicycle ignition on and off often, ride against the wind, ride uphill or are pedaling with a higher load on the bike, the battery will not last as long and you will not be able to travel as far using the battery.

Using Gears

Some model are equipped with gears. Gears are used to change the ratio between rotations of the rear wheel and the crank set. This enables you to pedal less and travel faster on flat or downhill sections, or pedal faster and travel slower to climb hills. Gearing is independent to pedal assistance, so pedal assistance operates the same regardless of selected gear. Remember, however, that pedal assistance is "governed" by overall speed.

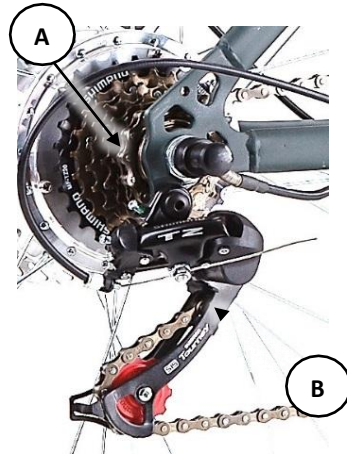

The freewheel (A) are located on the rear axle, known as a "gear cluster" or "cassette". The larger the gear, the less number of rotations per rotation of the crank. The largest gear is the "lowest" and is referred to as "1". As each gear becomes smaller, it is a "higher" gear than the previous and is numbered sequentially. The number of gears may vary between different models. Beneath the gear cluster is the derailleur mechanism (B), which moves the chain so it runs on different gears. The derailleur is operated by the rider using controls mounted on the handlebars. The gear change is "indexed" so each gear selection positively engages. There may be slight variations between bicycle models in method to change gear "up" (from a lower gear to a higher gear), or to change gear "down" (from a higher gear to a lower gear). The image shows a "7-speed" type that uses a button (C) for changing up gears (push button to activate derailleur), and a lever (D) for changing down gears (rotate lever forward to activate derailleur).

Using Brakes

All bicycle models are equipped with a front and rear wheel braking system. Brakes are used to slow the bicycle down. The braking systems may use different mechanics, however, the functionality is the same, and that is to change the energy of the moving bicycle into heat energy ("friction"):

- For disc brakes, this means pads made from a special friction material pinching against a disc mounted to the centre of the bicycle wheel.



Typical Disc Brake

The brakes are operated by the rider through levers mounted to the handlebars. The left-hand lever operates the front brake, the right-hand lever operates the rear brake. The ability of the rider to adequately slow and/or stop the bicycle depends largely on the skill of the rider, the surface being ridden on and other factors such as rain, tyres, adjustment and condition of the brake parts etc

Guidelines for Using Brakes

To get the best performance and service life from the brake system, understand and apply the following techniques:

- In wet conditions, which reduces friction, always provide additional distance for braking and adjust how quickly you apply the brakes.
- When applying the brakes, particularly the front brake, use a lower pressure to start with until you feel the brakes starting to "bite", then increase pressure as required. Do NOT over-apply the brakes and cause the wheel to stop rotating – this may result in loss of control.
- Maintain the brake friction components (pads, shoes, rubbers) in good condition and replace when they reach the wear limit.
- Maintain brake adjustment so that the brakes perform effectively, the levers are comfortably positioned, and there is not excessive play in adjustable components.
- If the brakes are not performing effectively, making abnormal noise or any part is not serviceable or cannot be adjusted correctly, have the brakes inspected and adjusted by a bicycle mechanic or suitably qualified person.
- If the brake cables become frayed or otherwise damaged, have them replaced by a bicycle mechanic or suitable qualified person.

Tyre Pressures

The tyres must always be inflated to the correct pressure (as specified on the tyre sidewall) before every ride. Riding the bicycle with either too low or too high pressures will affect bicycle performance, may affect effective electrical assistance range, and may render the bicycle as dangerous. Use an accurate pressure gauge when checking pressures.

Maintenance

ATTENTION:

Before carrying out any sort of maintenance, turn off the power switch and remove the ignition key.

Do some test riding and check the unit is riding normally and safely. Always keep your bike clean. For the battery poles, when dirty, clean them top prevent reduced efficiency or burnt poles. Your E-Bike should undergo an annual check-up. This will keep it in good working condition.

Adjust chain tension:

The chain may loosen after using the bike for a certain period of time, so please adjust the chain when necessary:

Loosen the bolts on the rear shaft, if the chain is loose, please adjust the Chain Bolts on both sides in clockwise until correct. If the chain is too tight, adjust the bolts using counter-clockwise rotation. Keep the crank gear and wheel gear aligned. If you are not experienced or confident, contact a bike specialist.

Adjusting the brakes:

Correct brake adjustment will make the controls easier and offer greater safety.

The brakes are adjusted in a similar fashion to any standard bicycle. It is important for the brakes to work correctly and that the electric cut-off devices to be in working order (Electric cable to the brake levers).

Once the brakes have been adjusted, make the wheels turn to ensure there is no binding and check that when either of the brake levers is pulled, the motor stops working.

Lubrication:

For a long service life the following parts of your E-Bike should be regularly lubricated every half year:

- Front axle
- Chain
- Rear axle
- Freewheel
- Front fork and other rotation parts.

For electrical parts, you do not need to lubricate them because they are lubricated in the factory. If you find anything wrong, please go to a bicycle specialist or contact Fortis.

Cleaning:

The bike should be cleaned with a damp sponge, taking special care not to get electrical parts wet (Battery connection, motor (rear axle), electric cables, handlebar controls, etc.). Dry with a cloth. When cleaning your electric bike, do not use a steady direct stream of water from a hose. Use a cloth to avoid short-circuiting any electrical components. Your electric bike has a durable finish and does not need to be waxed. Clean with a mild detergent and buff to restore its original shine if needed. For safety, longest possible service life and reliability, maintain the bicycle properly. Use the maintenance schedule below for guidance. It is very important that you check certain systems and components before each and every ride. The proper condition and function of these systems is critical to your safety.

Maintenance Schedule				
Component / Condition	Check Before Every Ride	*Check Periodically	Clean / Lubricate	Adjust / Tighten / Replace as Required
Tyre Pressure	■			■
Tyre Wear / Damage	■			■
Brake Adjustment	■			■
Handlebar Tightness	■	■		■
Controls and Displays	■			
Seat Post Tightness	■			■
Fasteners / Mounting Hardware				■
Brake Pads		■		■
Brake Cable Wear		■		■
Chain		■	■	■
Reflectors		■		
Battery / Charger		■		■
Steering Head Bearings		■	■	■
Derailleur		■	■	■
Wheel Spoke Tension		■		■
Wheel Trueness		■		■
Wheel Bearings		■	■	■
Bottom Bracket (Crank) Bearings		■	■	■

**Every 5 to 10 rides depending on ride length and conditions.*

Troubleshooting

Malfunction	Possible Cause	Possible Solution
Pedal assistance not working	<ol style="list-style-type: none"> Under-charged battery. Battery no longer serviceable. Battery charger faulty. Motor electrics or switches damaged / faulty. 	<ol style="list-style-type: none"> Charge battery. Follow battery care procedures. Have battery checked. Replace if faulty. Have charger checked. Replace if faulty. Seek diagnosis and repair from authorised service centre.
Reduced range and/or speed	<ol style="list-style-type: none"> Under-charged battery. Battery no longer serviceable. Low tyre pressure. Brakes dragging. Terrain, headwind, etc. 	<ol style="list-style-type: none"> Charge battery. Follow battery care procedures. Have battery checked. Replace if faulty. Inflate to recommended pressure. Adjust. Normal.
Gear change (where applicable) rough / not changing	<ol style="list-style-type: none"> Derailleur cables sticking / stretched / damaged. Derailleurs / shifter not correctly set. 	<ol style="list-style-type: none"> Lubricate / adjust / replace cables. Adjust.
Chain slip / jumping off sprockets	<ol style="list-style-type: none"> Worn sprockets. Stretched chain. Front sprocket loose / out of true. Sprocket teeth bent / broken. Derailleur / shifter not correctly adjusted. 	<ol style="list-style-type: none"> Replace. Replace. Re-true / tighten. Replace. Adjust.
Clicking noises when pedaling	<ol style="list-style-type: none"> Stiff chain link. Loose pedals / bearings. Loose bottom bracket / bearings. Bent bottom bracket or pedal bolt. Loose pedal arm bolts. 	<ol style="list-style-type: none"> Lubricate chain. Tighten / adjust bearings. Tighten / adjust bearings. Replace. Tighten.

Grinding noise when pedaling	<ol style="list-style-type: none"> 1. Pedal bearings too tight. 2. Bottom bracket bearings too tight. 3. Rear wheel not straight. 4. Chain too tight. 5. Derailleur dirty. 	<ol style="list-style-type: none"> 1. Adjust. 2. Adjust. 3. Align so chain straight. 4. Adjust. 5. Clean and lubricate.
Brakes not effective	<ol style="list-style-type: none"> 1. Pads worn. 2. Pads / discs dirty. 3. Brake cables binding / stretched / damaged. 4. Brakes levers binding. 5. Brakes require adjustment. 	<ol style="list-style-type: none"> 1. Replace. 2. Clean and degrease. 3. Lubricate / adjust / replace cables. 4. Clean pivots. 5. Adjust.
Brakes squeal	<ol style="list-style-type: none"> 1. Pads / discs dirty. 2. Brakes not centred. 3. Caliper fasteners loose. 	<ol style="list-style-type: none"> 1. Clean and degrease. 2. Centre brakes and adjust. 3. Tighten.
Brakes chatter / vibrate	<ol style="list-style-type: none"> 1. Brake mounting bolts loose. 2. Brakes out of adjustment. 3. Steering head bearings loose. 	<ol style="list-style-type: none"> 1. Tighten. 2. Centre brakes and adjust. 3. Adjust bearings.
Wheel vibration / wobble	<ol style="list-style-type: none"> 1. Axle bent or broken. 2. Wheel out of true. 3. Wheel hub bearings loose / not serviceable. 4. Quick-release (if equipped) mechanism loose. 	<ol style="list-style-type: none"> 1. Replace. 2. True wheel. 3. Adjust / replace. 4. Adjust.
Steering not accurate	<ol style="list-style-type: none"> 1. Wheels not aligned to frame. 2. Steering head loose / binding. 3. Front forks or frame bent. 	<ol style="list-style-type: none"> 1. Align wheels. 2. Adjust. 3. Straighten.
Motor "clicks" / has reduced power and/or shuts off	<ol style="list-style-type: none"> 1. Under-charged battery. 2. Motor internal fault. 	<ol style="list-style-type: none"> 1. Charge battery. Follow battery care procedures. 2. Replace.

No power when pedal assistance switched ON	<ol style="list-style-type: none"> 1. Blown fuse. 2. Loose connectors / wiring damage. 3. Faulty switch. 4. Faulty controller. 	<ol style="list-style-type: none"> 1. Replace. 2. Check connectors / wiring. Replace as required. 3. Replace. 4. Replace.
Pedal assistance OK, but no display	<ol style="list-style-type: none"> 1. Loose connectors / wiring damage. 2. Faulty controller. 	<ol style="list-style-type: none"> 1. Check connectors / wiring. Replace as required. 2. Replace.
Display OK, but no pedal assistance	<ol style="list-style-type: none"> 1. Loose motor connectors / wiring damage. 2. Poor contact at battery terminals. 3. Faulty braking sensor. 	<ol style="list-style-type: none"> 1. Check connectors / wiring. Replace as required. 2. Inspect and clean terminals. 3. Replace.
Bicycle runs at full speed without pedalling	<ol style="list-style-type: none"> 1. Faulty crank sensor. 2. Faulty controller. 	<ol style="list-style-type: none"> 1. Replace. 2. Replace.
Pedal assistance operating intermittently or not as expected	<ol style="list-style-type: none"> 1. Loose connectors / wiring damage. 2. Faulty controller. 3. Faulty crank sensor. 	<ol style="list-style-type: none"> 1. Check connectors / wiring. Replace as required. 2. Replace.
Charger shows "full charge" in an unusually short amount of time	<ol style="list-style-type: none"> 1. Faulty charger. 2. Faulty batteries. 	<ol style="list-style-type: none"> 1. Replace. 2. Replace.
Charger indicator not illuminating when charger is plugged into outlet	<ol style="list-style-type: none"> 1. Outlet has no power. 2. Faulty charger. 	<ol style="list-style-type: none"> 1. Check charger plugged in and electrical supply ON. 2. Replace.
Charger indicator flashes red and never changes to green	<ol style="list-style-type: none"> 1. Damaged wire from charger to battery. 2. Faulty batteries. 	<ol style="list-style-type: none"> 1. Replace charger. 2. Replace.

12 Month Limited Warranty

We warrant against possible manufacturing defects providing the following conditions are satisfied:

- Product is completely and correctly assembled
- Product is used under normal condition for its intended purpose
- Product receives all necessary maintenance and adjustments
- Product is used for general transportation or recreational use only

What is covered by this Limited Warranty;

1 Year Frame only

1 Year Warranty on Motor only

1 Year Warranty on Battery only

What is not covered by this Limited Warranty:

- When the bicycle is used negligently or results in damage due to traffic accident.
- Top Speed is not covered under warranty, if your electric bike does not reach estimated top speeds, this is not covered under warranty.
- If your electric bike does not reach the factory estimated distance advertised, and can vary depending on how you use the electric bike and the total weight carried, this is not covered under warranty.
- All batteries will and do lose capacity over time, capacity loss is not covered under warranty. (If the battery unit is used incorrectly or seal tampered with, this will void your battery warranty). Others that is not covered under warranty for battery are; If you have not charged your battery regularly, left your battery sitting unused for over more than 3 months, If you damaged your charger or battery by incorrect use.
- When your battery starts to lose capacity, and runs for less distance, this is not covered under warranty.
- Damage due to normal wear and tear and maintenance. Parts that are not covered under warranty under normal wear and tear include; tires, tubes, brakes, brake pads, derailleur and gear adjustments, tightening on all nuts, spokes, bottom bracket, chain and general adjustments (Please have your bike service regularly by a bicycle mechanic)
- Rust and corrosion on bike is not covered under warranty.
- Damage due to external causes will not be covered under warranty.
- Any minor scratches, marks or imperfections will not be covered.

Warranty will be void if the product is ever:

- Used in any competitive sport
- Modified in any way, includes but not limited to: modifications to the bicycle , components , electrical components
- Misused, abused or neglected
- Rented, for commercial use, sold or given away

DWMEIGI will not be liable for incidental or consequential loss or damage due directly or indirectly from use of this product.

Warranty and Repair Claim

To claim your warranty, please provide proof of purchase and contact us via email or phone listed below.

The cost of sending and returning of your DWMEIGI electric bike is at the customers expense.

Warranty repair timeframe may take up to 60 days depend on replacement part availability. If there is a delay due to the nature of the repair, or a delay beyond our control, we will inform you and do whatever possible to limit the turnaround time of your product.

Other Repairs

All DWMEIGI electric bike repairs which is not covered by warranty can also be repaired at authorised service centre at the customers cost. We will carry most of the spare parts on our current and past models. Should you wish to purchase any parts, please contact us.

Contact Information

Website: www.dwmeigi.com

Address: 9439 Archibald Ave Unit 101, Rancho Cucamonga, CA 91730

Email: support@dwmeigi.com

Our goods and services come with guarantees that cannot be excluded under the United States Consumer Law. For major failures with the service, you are entitled:

- to cancel your service contract with us; and
- to a refund for the unused portion, or to compensation for its reduced value.

You are also entitled to choose a refund or replacement for major failures with goods. If a failure with the goods or a service does not amount to a major failure, you are entitled to have the failure rectified in a reasonable time. If this is not done you are entitled to a refund for the goods and to cancel the contract for the service and obtain a refund of any unused portion. You are also entitled to be compensated for any other reasonably foreseeable loss or damage from a failure in the goods or service.



Some experts believe that the incorrect or prolonged use of almost any product may cause serious injury or death. To help reduce your risk of serious injury or death, refer to the information below.

- | | |
|---|---|
| <ul style="list-style-type: none"> ▪ Consult all documentation, packaging and product labelling before use. Note that some products feature documentation available online. It is recommended to print and retain the documentation. ▪ Before each use, check the product for loose/broken/damaged/missing parts, wear or leaks (if applicable). Never use a product with loose/broken/damaged/missing parts, wear or leaks. ▪ Products must be inspected and serviced (if applicable) by a qualified technician every 6 months. This is based on average residential use by persons of average size and strength, and on a property of average metropolitan size. Use beyond these recommendations may require more frequent inspections/servicing. ▪ Ensure that all users of the product have completed a suitable industry recognized training course before being allowed access to the product. | <ul style="list-style-type: none"> ▪ The product has been supplied by a general merchandise retailer that may not be familiar with your specific application or description of application. Be sure to attain third-party approval from a qualified specialist for your application before use, regardless of any assurances from the retailer or its representatives. ▪ This product is not intended for use where fail-safe operation is required. As with any product (for example, automobile, computer, toaster), there is the possibility of technical issues that may require the repair or replacement of parts, or the product itself. If the possibility of such failure and the associated time it may take to rectify could in any way inconvenience the user, business or employee, or financially affect the user, business or employee, then the product is not suitable for your requirements. This product is not intended for use where incorrect operation or a failure of any kind, including but not limited to, a condition requiring product return, replacement, parts replacement or service by a technician may cause financial loss, loss of employee time or an inconvenience requiring compensation. ▪ If this product has been purchased in error when considering the information presented here, contact the retailer directly for details of their returns policy, if required. |
|---|---|

If you have any questions regarding any issues with your electric bicycle, please contact our Customer Support team on www.dwmeigi.com

©2023 DWMEIGI. All rights reserved. No part of this document, including descriptive content, concepts, ideas, diagrams or images may be reproduced or transmitted in any form or by any means, electronic or mechanical, including photocopying, scanning or recording, or any information storage and retrieval system, without express permission or consent from the publisher

