



DUKERS

Quality Commercial Refrigeration











CHEST FREEZER

BD/BG-760



PRODUCT FEATURES

-  Fan assisted condenser & copper evaporator.
-  Temperatures in the cabinet range from -10 to 0 degrees Fahrenheit.
-  R290 Natural Refrigerant promotes faster cool down and efficient energy consumption.
-  White coated steel exterior & aluminum interior, defrost drain.
-  Epoxy coated white baskets.
-  3" casters.
-  Solid hinged lid.
-  Digital controller and LED temperature display.
-  Interior LED light.



TECHNICAL SPECIFICATIONS

Refrigerant	R290
Type of Defrost	Manual
Interior Finish	White
Interior Finish	Embossed aluminum
Temperature Range °F	-10 ~ 0 °F
Compressor Power (HP)	4/9
Nema Config.	NEMA5-20P



HIGH QUALITY STAINLESS STEEL & ROBUST DESIGN



DUKERS

Los Angeles | San Francisco | Dallas
Houston | Florida | Chicago | New Jersey

1-800-931-8628

@ info@dukersusa.com

www.DukersUSA.com

DETAILS & SPECIFICATIONS

CHEST FREEZER BD/BG 760

Front View

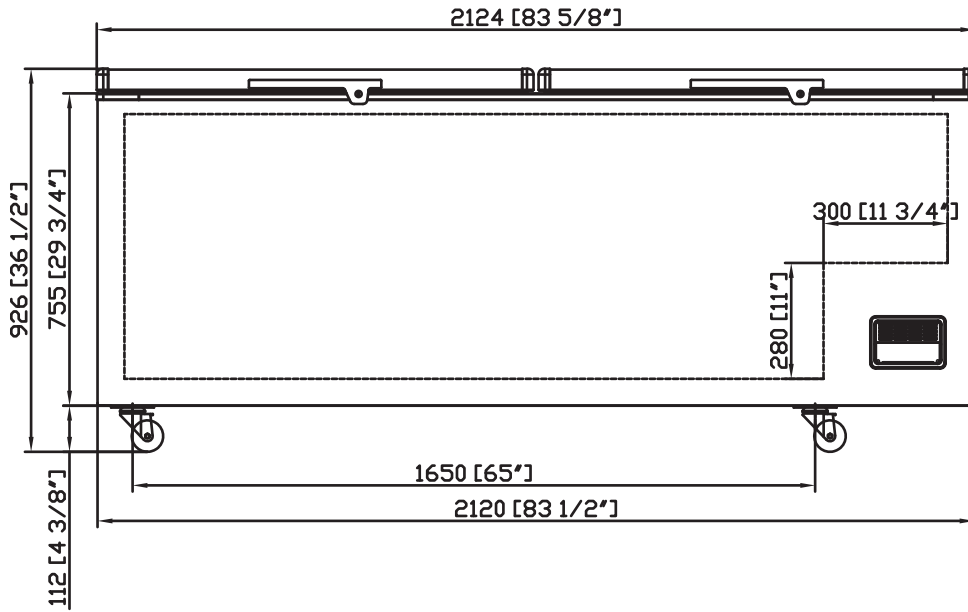

Side View

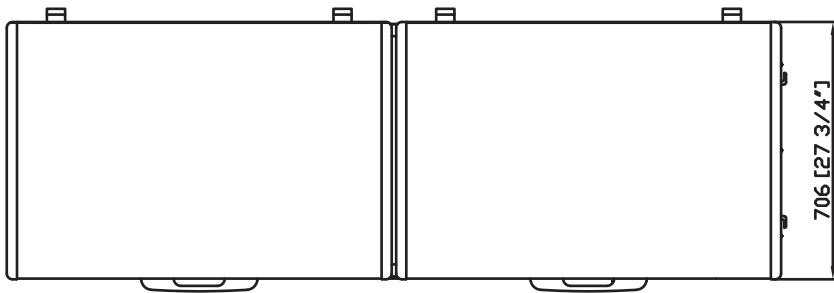
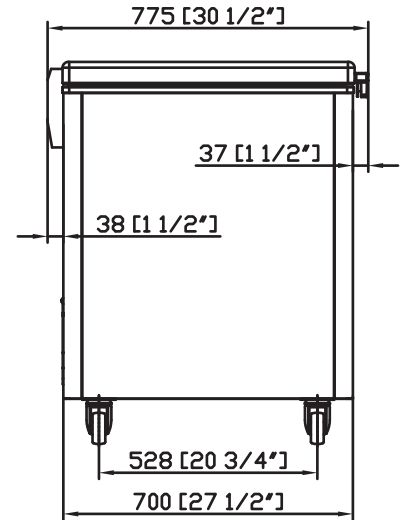

Top View

MODEL BD/BG 760

Number of baskets	2
Compressor Power (HP)	4/9
Refrigerant	R290
Volume	24.1 cu ft

MODEL	EXTERNAL DIMENSION WXDXH (INCHES)	PACKAGING DIMENSION WXDXH (INCHES)	PRODUCT NET WEIGHT	# OF BASKETS	40HQ CONTAINER CERT.
BD/BG 760	83 5/8 x 27 3/4 x 36 1/2	88 5/8 x 34 1/8 x 38	198.42 lbs	2	26



Los Angeles | San Francisco | Dallas
Houston | Florida | Chicago | New Jersey

1-800-931-8628

@ info@dukersusa.com

www.DukersUSA.com