

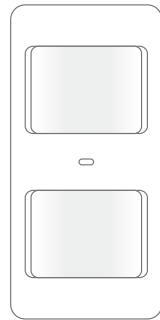

Pet-Immune PIR Motion Detector

PIR-910

User Manual



Introduction

The motion detector is with high performance. It consists of digital dual-core fuzzy logic infrared control chip and intelligent analysis which effectively identify interference signal from body movement signals and reduce false alarm rate. With automatic temperature compensation and anti-turbulence technology, it easily adapts to environment changes. The detector also has the advantage of energy saving, reliability and easy installation. It is suitable for lobby, hallway detection with a detective range of 0-8m at front. With low power feedback function, the user will get SMS alert about low battery if the PIR detector had connected to alarm system.

Product Overview

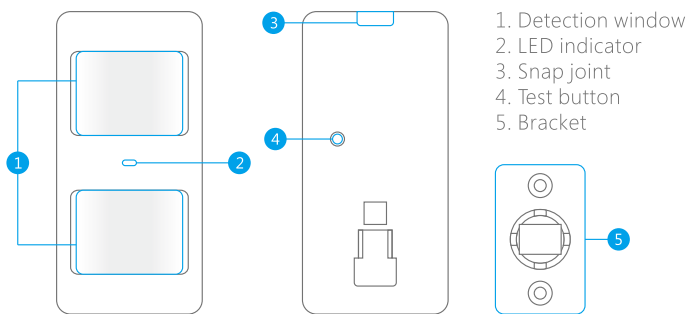

LED Indication

Display	Meaning
Blink continuously	Self testing
Blink once	Intrusion detected
Blink twice	Testing mode is finished, the detector enters power-saving mode
Blink once every 3 seconds	Low battery, please replace the battery as soon as possible

PCB Layout

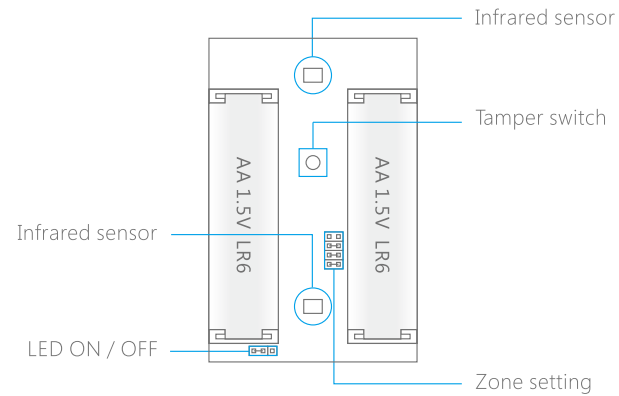

Infrared sensor: It detects the infrared rays released by human body motion, please don't touch the surface and always keep it clean.

Tamper switch: Once the case is opened in work mode, the tamper switch is triggered and then generates an alarm signal.

Detection Range

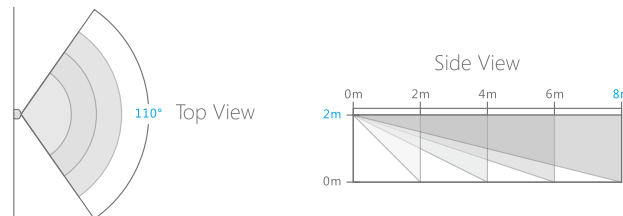

Pet Immune Function

This sensor adopts dual detection window design to improve detection accuracy. It was only when both detection windows detect body movement will it trigger an alarm. While only one window will not cause an alarm. Based on this principle, pets less than 25 kg will not be detected by the sensor.

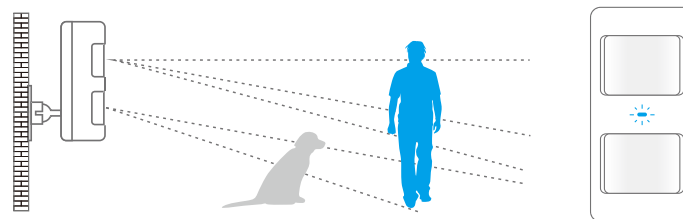

Pairing to Control Panel

Control panel enters pairing state
Make the control panel in pairing state.

Press the test button

Press the test button on the back of the detector twice, the control panel beeps once to indicate a successful pairing.

Note: If the control panel beeps twice when the above operation is done, it means the detector has been paired already.

Working Mode

Testing Mode

Press the test button, the detector enters testing mode and detects once every 10 seconds. After 3minutes, the LED indicator blinks twice, and the detector switches to power saving mode.

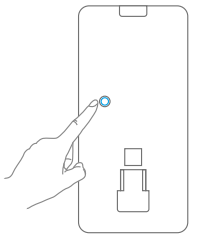

Power Saving Mode

This motion detector has smart power saving function. If the detector is triggered twice within 3 minutes, it enters sleeping state immediately to save power. During this period, any movement detected does not generate an alarm. After no movement within the next 3 minutes, it goes back to working state again.

Note: When the detector goes into sleeping state, the precondition of alarm is that no one moves in 3 minutes in the detection area; otherwise it will remain in the sleeping state.

If the detector is in sleeping state, it is suggested to leave the room and make sure nobody moves in the detection area. The detector will go back to working state in 3 minutes.

Test

It is to check whether the PIR Motion Detector can work properly or not.

Remove the insulation strip

Press down the snap joint, open the case, and remove the insulation strip to activate batteries. After self-testing for 1 minute, it enters working state.

Arm the system

Make sure the alarm system is in armed state.

Trigger an alarm

Press the test button until an alarm is triggered. The detector is proved to be connected successfully and ready for installation.

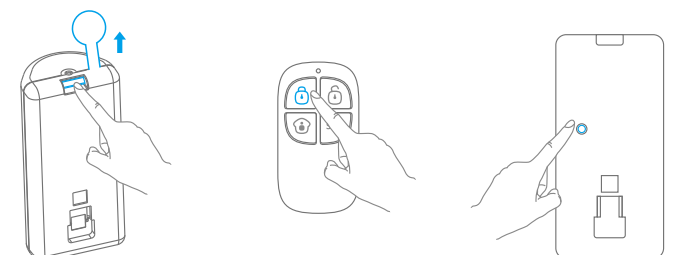

Installation

After making sure the detector works normally, do as follows:

Choose a suitable installation location

It is recommended to mount it at the height of 2-2.2m from the ground.

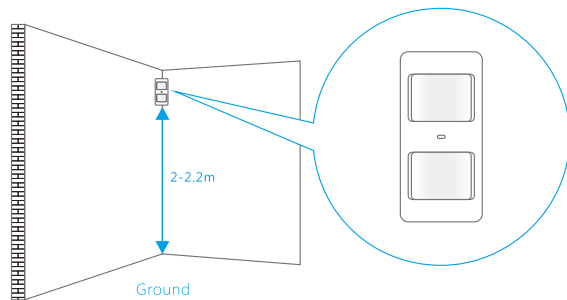

Fix the detector

Fix the bracket on the wall with screws and attach the detector to the bracket.

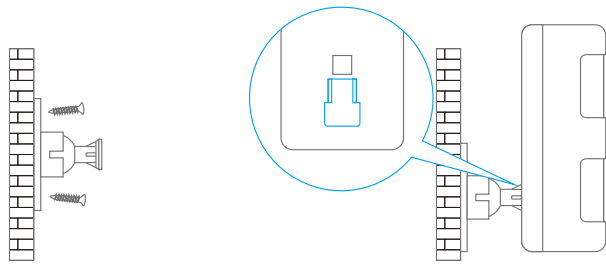

Test the PIR motion detector

Press the test button at the back. It switches to the testing mode and sustains for 3 minutes. Walk in the detection scope and observe the LED. When body movement is detected, the LED blinks once.

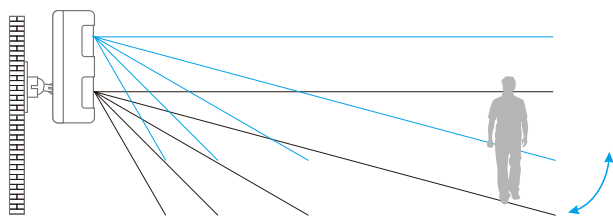

Adjust the angle

Adjust the bracket angle to achieve the best detection effect.



Note: If pet-immune function is applied, please do not adjust the angle up or down, but keep it parallel with the wall.

Installation Notices

Mount the detector to a location close to the entrance or exit

The detector aims at preventing intrusion. Detecting human movement at the entrance or exit is critical for security.

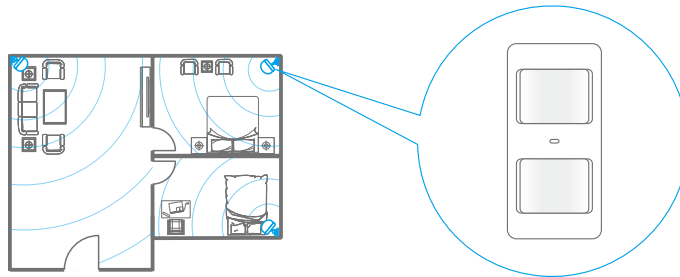

Mount the detector in a proper angle

The installation angle affects detection sensitivity. The sensitivity is optimal when the walk direction is vertical to the infrared direction. Choose the best location and angle according to the actual situation and detection scope diagram.

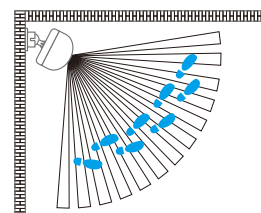

Don't face glass windows or doors

Strong light interferes with detection sensitivity. In addition, complicated situations, such as traffic flow, stream of people, also should be avoided.

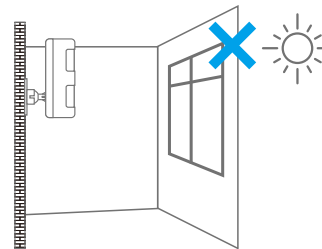

Don't face or position close to heat sources

Heat and cold sources, such as heat extraction units, heaters, air conditioner, microwave oven, refrigerator, which may cause false alarm, should be avoided.

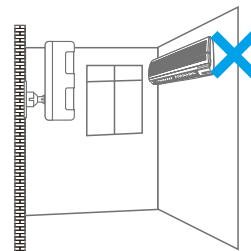

Don't face swinging objects

Swinging objects may also trigger false alarm. Besides, if there are two detectors covering the same scope, adjust the locations to prevent cross-interference.

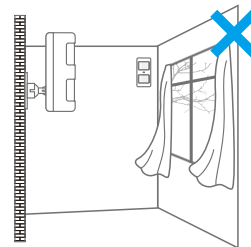

Specifications

Power Supply DC 3V (AA 1.5V LR6 Battery x 2 pcs)

Static Current < 18uA

Alarm Current < 12mA

Detection Scope 8m/110°

Pet Immunity < 25kgs

Transmitting Distance < 80m (Open area/ no interference)

Radio Frequency 315MHz or 433.92MHz (±75KHz)

*Only 433.92MHz is available for Europe for Europe&Australia

ERP (dBm).MAX -7.44

Housing Material ABS plastic

Operation Condition Temperature: 0°C to 50°C

Relative Humidity: < 80% (non-condensing)

Detector Dimensions (L x W x H) 108 x 52 x 36.8 mm

Bracket Dimensions (L x W x H) 52 x 30 x 26.5 mm

CE Declaration of Conformity

Hereby, Chuango AIoT GmbH declares that the radio equipment type PIR-910 Motion Detector is in compliance with Directive 2014/53/EU. The full text of the EU declaration of conformity is available at the following internet address:

https://www.chuango.com/english/compliance_PIR-910

INFORMATION FOR THE USERS

At the end of its life, the device has to be separated from the other waste. Consign the device and all its components together to a center of electrical and electrotechnical waste recycling center, designated by your local authorities.



2006/66/EC and its amendment 2013/56/EU (battery directive): This product contains a battery that cannot be disposed of as unsorted municipal waste in the European Union. See the product documentation for specific battery information.

The battery is marked with this symbol, which may include lettering to indicate cadmium (Cd), lead (Pb), or mercury (Hg). For proper recycling, return the battery to your supplier or to a designated collection point. For more information see: www.recyclethis.info.