

Note: All baths in Australia come standard **without** an overflow.

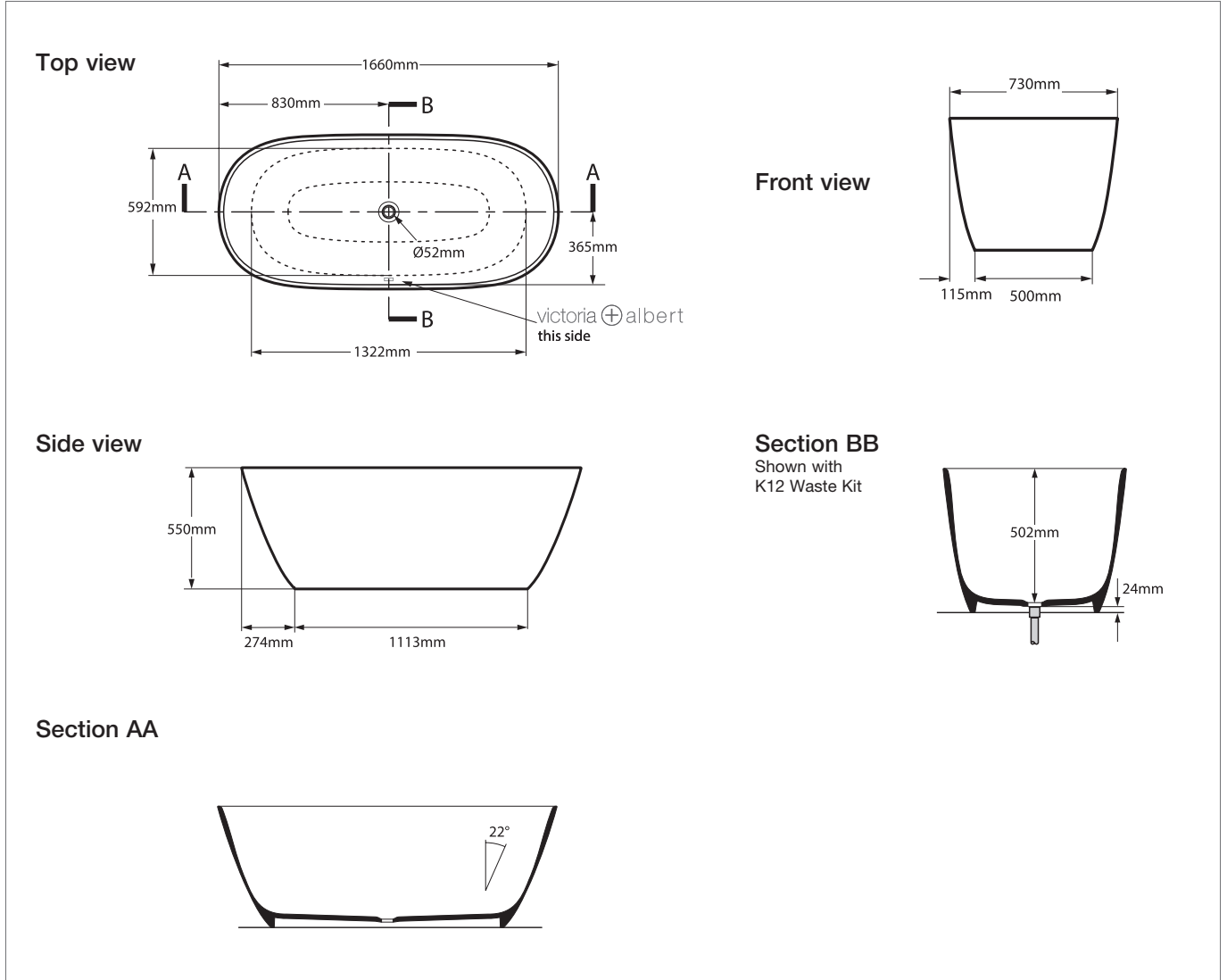



Lussari 1700

LU2-N-SW-NO / LU2M-N-SM-NO

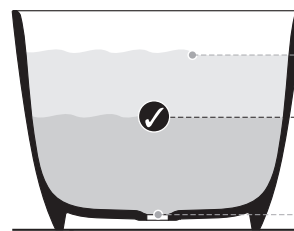

 rich in Volcanic Limestone™



 355	 283 ltr
 227	 155 ltr
 72	 0 ltr

BV-2.1_0081

Recommended wastes: K-12-xx / K-17-xx

*All measurements subject to +/-5% tolerance
*Overflow hole not drilled

 Massachusetts Code: Pending
cUPC listing by IAPMO: Pending

25
years

Guaranteed for residential use for 25 years*
25 Jahre Garantie bei privater Nutzung
25 ans de garantie pour un usage domestique
Garantía de 25 años para uso domestico
La sicurezza garantita per uso residenziale per 25 anni

8
years

Guaranteed for commercial use for 8 years*
8 Jahre Garantie bei gewerblicher Nutzung
8 ans de garantie pour un usage commercial
Garantía de 8 años para uso comercial
La sicurezza garantita per uso commerciale per 8 anni

- QUARRYCAST™ white products only. Paint finish exterior guaranteed for 2 years.
- Nur auf weisse QUARRYCAST™ Produkte. Auf Aussenlackierung gibt es 2 Jahre Garantie.
- Uniquement pour les produits en QUARRYCAST™ blanc. Pour les finitions extérieures peintes la garantie est de 2 ans.
- Solo sobre productos en QUARRYCAST™ blanco. Acabados de pintura exterior tienen una garantía de 2 años.
- Solo per prodotti bianchi in QUARRYCAST™. Finitura esteriore dipinta garantita per due anni.