

# Kaali 48 UB-KAA-48-IO

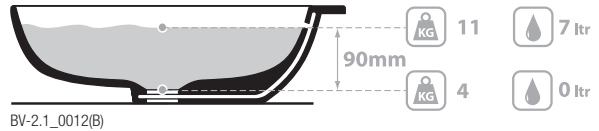
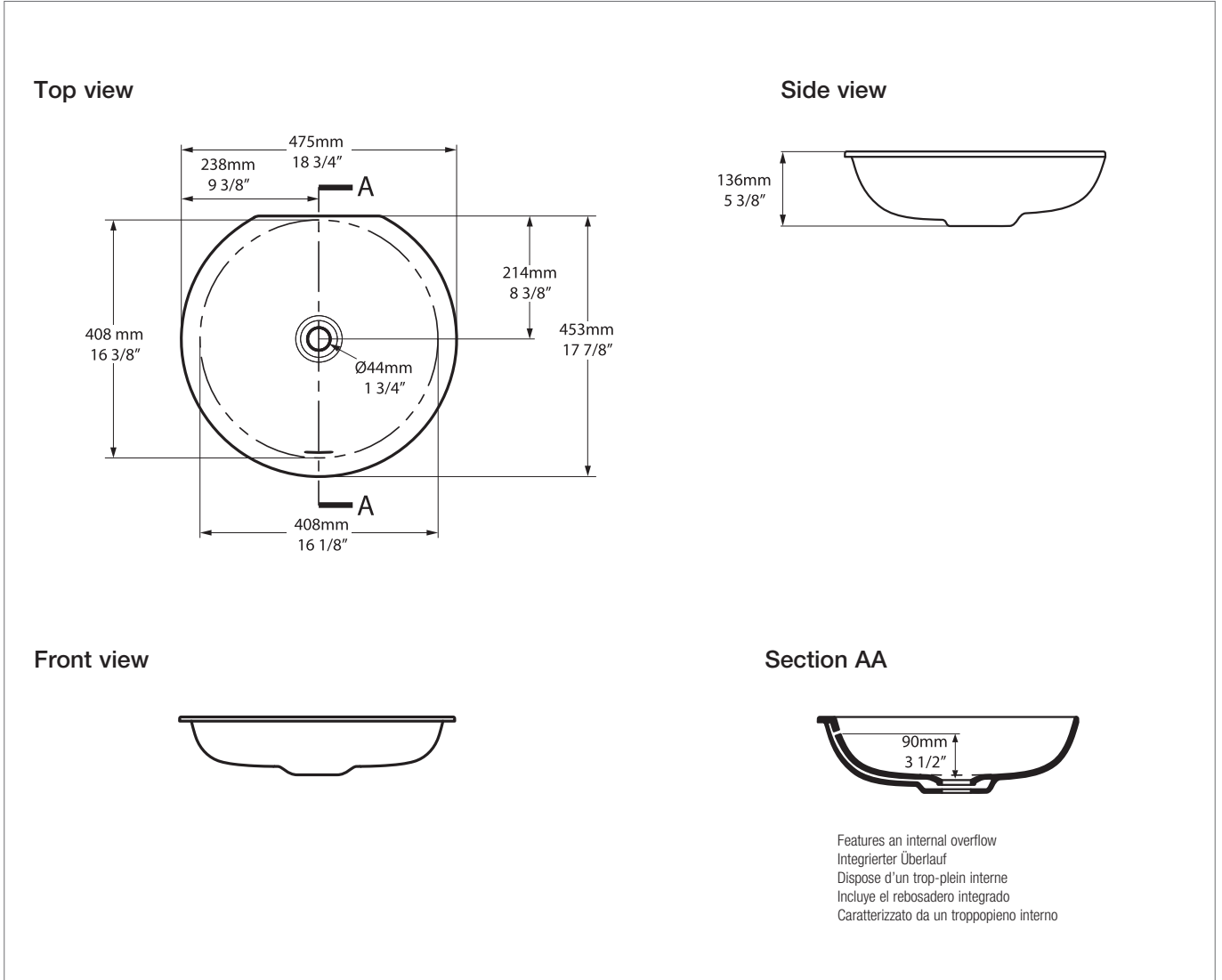

**Qc** rich in Volcanic Limestone™

**Recommended wastes: K-25-xx**

\*All measurements subject to +/-5% tolerance

**25**  
years

Guaranteed for residential use for 25 years  
25 Jahre Garantie bei privater Nutzung  
25 ans de garantie pour un usage domestique  
Garantía de 25 años para uso domestico  
La sicurezza garantita per uso residenziale per 25 anni

**8**  
years

Guaranteed for commercial use for 8 years  
8 Jahre Garantie bei gewerblicher Nutzung  
8 ans de garantie pour un usage commercial  
Garantía de 8 años para uso comercial  
La sicurezza garantita per uso commerciale per 8 anni



Massachusetts Code: Pending  
cUPC listing by IAPMO: File No. 6970