



## Features

- EWATER+ spreads out and keeps the nozzle clean by preventing bacteria with sanitizing effect
- PREMIST water is sprayed inside the toilet bowl to make it difficult for dirt to adhere
- Fully equipped with comfortable rear, front and oscillating cleansing functions
- Adjustable WARM AIR DRYING
- HEATED SEAT with temperature control
- Auto powerful DEODORIZER activates after every usage

EWATER+ is made from tap water by electrolyzed chloride ion without any chemicals. After use, it returns to normal water in the state of safe and environmental friendly

## Specifications

Bowl Shape:	Elongated
Water Pressure:	0.05Mpa~0.75Mpa
Power Rating:	220~240V , 50/60Hz, 306~361W
Length of Power Cord:	1.2 m
Material:	Plastic
Size:	472W x 530D x 147H mm

## Parts description

- TCF23410AAA  
WASHLET  
Elongated





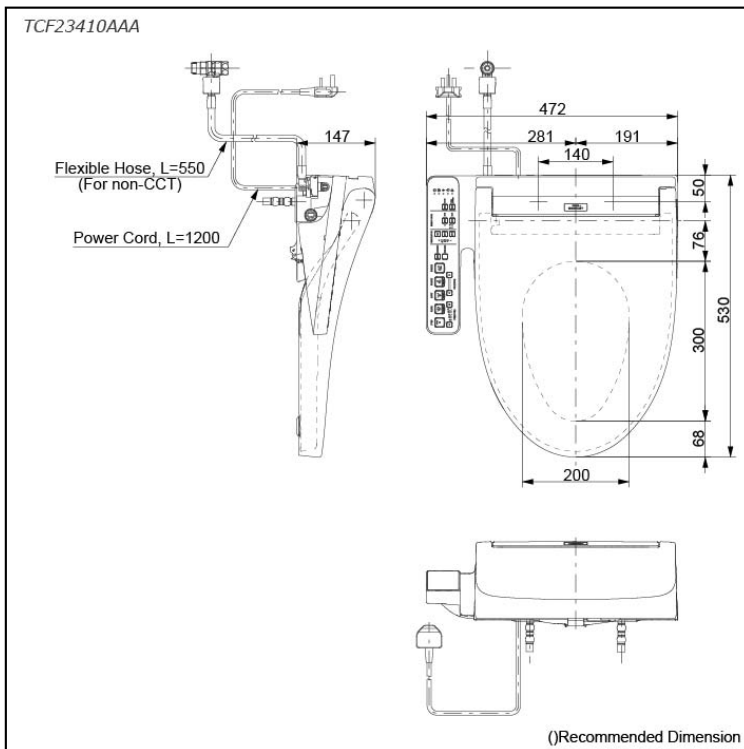





## Colors

White #NW1



# TOTO Benefits & Technologies

The table below lists TOTO's general features. Not all models have every feature. Please check the specification sheet for each model and associated icons for clarification.

	TORNADO FLUSH	TORNADO FLUSH not only cleans more effectively, it does so quietly using less water. Powerful streams of water merge and swirl 360 degrees, washing every spot inside the RIMLESS toilet bowl.
	RIMLESS	The RIMLESS design not only leaves no place for waste and germs to hide. It also makes for a much easier to clean toilet.
	CEFIONTECT	CEFIONTECT is an ultra-smooth ceramic glaze that coats the toilet bowl. Its microscopic surface ridges are far smaller than waste particles, leaving no place for waste to gain a foothold. Extremely durable, CEFIONTECT is designed for enduring beauty and cleanliness.
	AIR-IN WONDER WAVE	AIR-IN WONDER WAVE is a technology that uses air rich water droplets to produce a more comfortable washing sensation and deliver more thorough cleansing with less water consumption. Even more, water is warmed instantly as needed, so you need never worry about running out of warm water.
	EWATER +	EWATER+ washes the wand and toilet bowl where waste and bacteria tend to accumulate and produce stains that can become permanent. Using no chemicals or cleaning agents, EWATER+ provides peace of mind every day that microscopic bacteria has no place to hide.
	WATER SAVING	Save water by offering half/full flush options.
	AUTO OPEN/CLOSE LID & SOFT LIGHT	Eliminating the need to touch the toilet surfaces, the lid automatically opens and closes when the toilet is approached and departed. Auto Soft light function usable for night time usage.
	DEODORIZER	Highly effective deodorizing automatically takes places inside the toilet bowl both during and immediately after use, leaving no disturbing odors.
	HEATED SEAT	The moment you approach the toilet, the seat begins warming to a comfortable temperature.
	WARM AIR DRYING	Fully equipped with comfortable rear, front and oscillating cleansing and drying functions.
	PREMIST	PREMIST automatically sprays water over the surface of the inner toilet bowl before every use. Due to the ceramic's hydrophilic nature, waste washes away more easily.