

**1.9948.05.0.IS**

**WALL MIXER DIVERTER**

**INSTALLATION INSTRUCTIONS**

## **IMPORTANT INFORMATION:**

- For servicing the cartridge, isolate the water supply, remove the handle, remove the locknut from on top of the cartridge and remove the cartridge. Do not overtighten the locknut when reinstalling. The locknut should be tightened firmly, but not excessively.
- All tapware and plumbing must be tested for leaks and functionality before sheeting off / concealing the wall as per AS3500. This includes independently testing the hot and cold operation of the mixer.
- Water pressure must not exceed 500kpa as per AS3500, or the product warranty will be void.
- Pressure difference between hot and cold must not exceed 150kpa.
- This product is designed to work on high pressure systems only.
- Before sheeting the walls it is important that the system is checked for water hammer. If water hammer is apparent, all possible measures are to be taken, including but not limited to ensure pipework is correctly secured, keeping the length of the pipework from the outlet as short as possible, and the fitting of outlets which have a high star rating. Ensure that water pressure is not exceeding 500kpa, ensuring the correct pipe size is installed. Install an air chamber or water hammer arrestor if required.
- Ensure wall sheets and tiles are installed as close to the waterproofing sleeve as possible.
- Ensure waterproofing sleeve is not deformed. If the waterproofing sleeve is deformed by wall linings, the trim kit will not be able to be installed.
- Use of the provided insulation is optional. If the insulation is not used, Brodware recommend using another form of acoustic barrier around the body / breech.

# WALL MIXER DIVERTER INSTALLATION GUIDE

(except for Yokato, Minim and Progressive mixer ranges)

---

## ROUGH IN PROCESS

1. Set-back for rough in of the mixer body assembly is 55-70mm, from the back of the mixer body assembly to the finished wall face (Fig.B). NOTE: If the optional 1.9305.BK.0.00 Adjustable Install Kit is being used, add 2mm to the set-back to accommodate the kit.
2. As per Fig. A, the hot inlet port is on the left, the cold inlet port is on the right. The mixer body should always be installed with the mixer top the top and diverter on the bottom.
3. Remove the insulation. Secure the assembly to a noggin in the desired installation location and position by screwing through the 4 black rubber bushes on each corner of the mounting plate. We suggest using a pan head screw with a loose washer (Fig.A).
4. Flush water Lines. Connect plumbing to mixer body. Ensure the mixer cartridge locknut is tight.  
NOTE: Clockwise rotation of the diverter handle opens the bottom outlet port. Anti-clockwise rotation of the diverter handle opens the top outlet port. Test as per AS3500. Check operation and test for leaks before plastering or tiling. (If water hammer is apparent, please refer to the "IMPORTANT INFORMATION" section of this instruction booklet)
5. Refit the insulation (optional – refer to the "IMPORTANT INFORMATION" section of this installation instruction). Ensure the waterproofing sleeve is screwed down fully over the o-ring to ensure a positive seal. Press the sleeve cap into the waterproofing sleeve (Fig. B).
6. Sheet the wall. Waterproof to the waterproofing sleeve. Waterproofing membrane should be applied on both sides of the waterproofing aid supplied. **NOTE: the waterproofing aid is optional for installation. Assess if this should be used on your installation. All waterproofing liability is with the installer.**
7. Finish concealing the wall.

## FINAL FIT OFF PROCESS

1. Cut down the waterproofing sleeves flush with the finished wall face (Fig.D). Hold the waterproofing sleeve in position while cutting, to ensure that the waterproofing sleeve does not unscrew from inside the wall. Do not cut the internal o-ring, as this will prevent the trim kit from being fitted. Apply silicone between the waterproofing sleeve and the wall face.
2. Press fit mixer sleeve onto mixer body. Screw the locknut cover over mixer cartridge.
3. Fit diverter sleeve to the diverter .
4. Fit coverplate over mixer diverter and press to the finished wall. Hold the coverplate in place against the finished wall face with the small mixer and diverter trims.
5. Fit the mixer handle to the mixer with the lever pin pointing up. Fit diverter handle bush to the diverter. Fit the diverter handle with the lever pin pointing down. Secure in place with grub screws and allen key.
6. Test the operation.

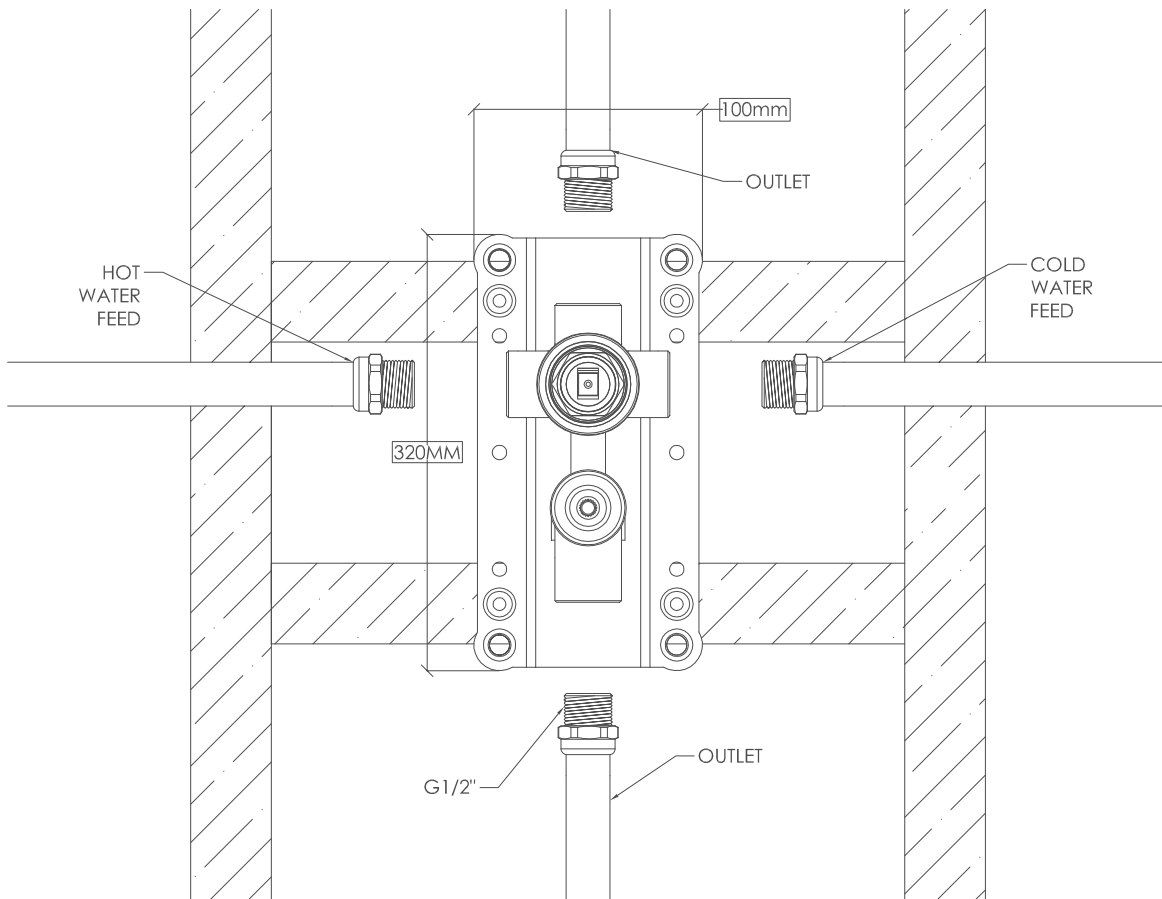

Fig.A

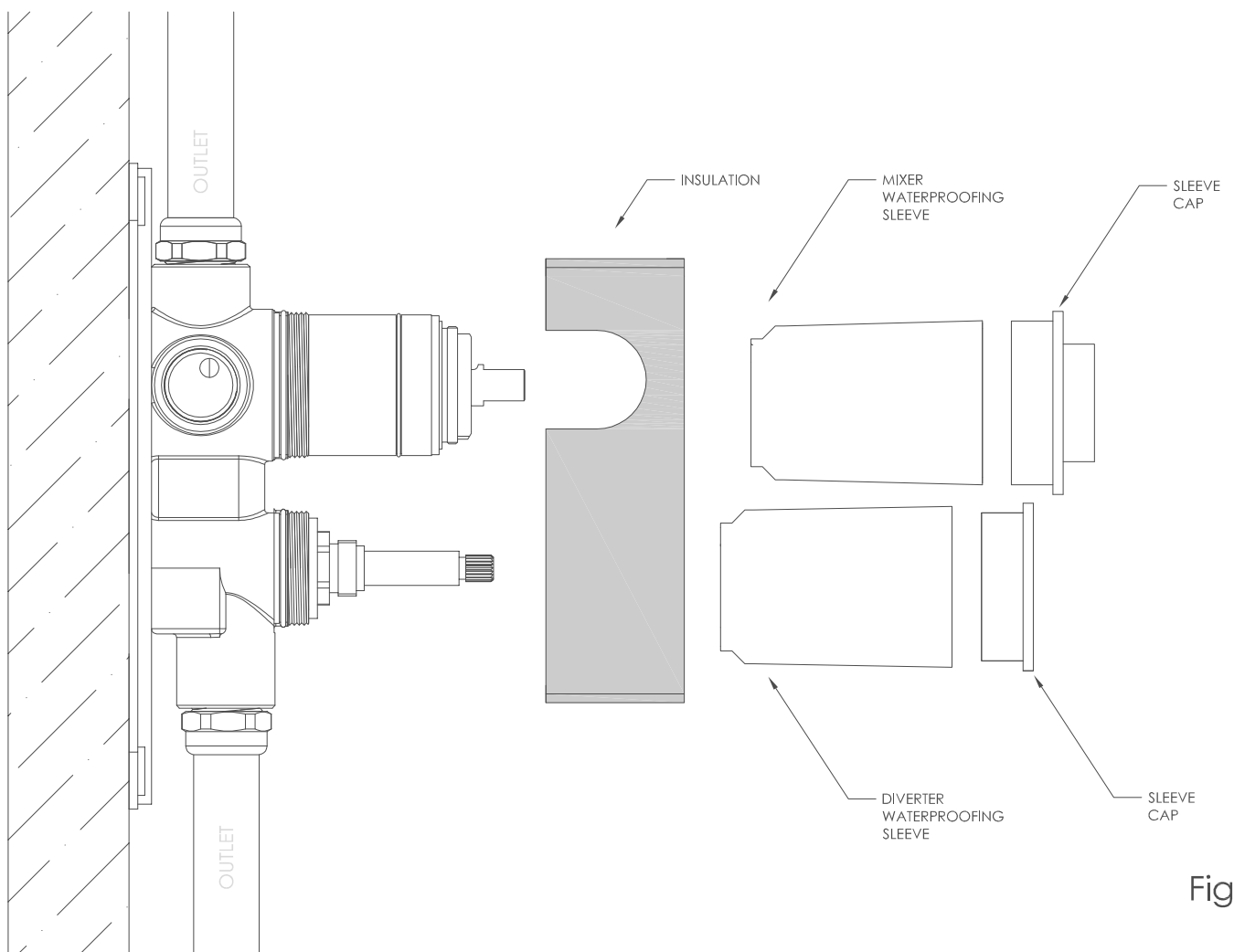

Fig.B

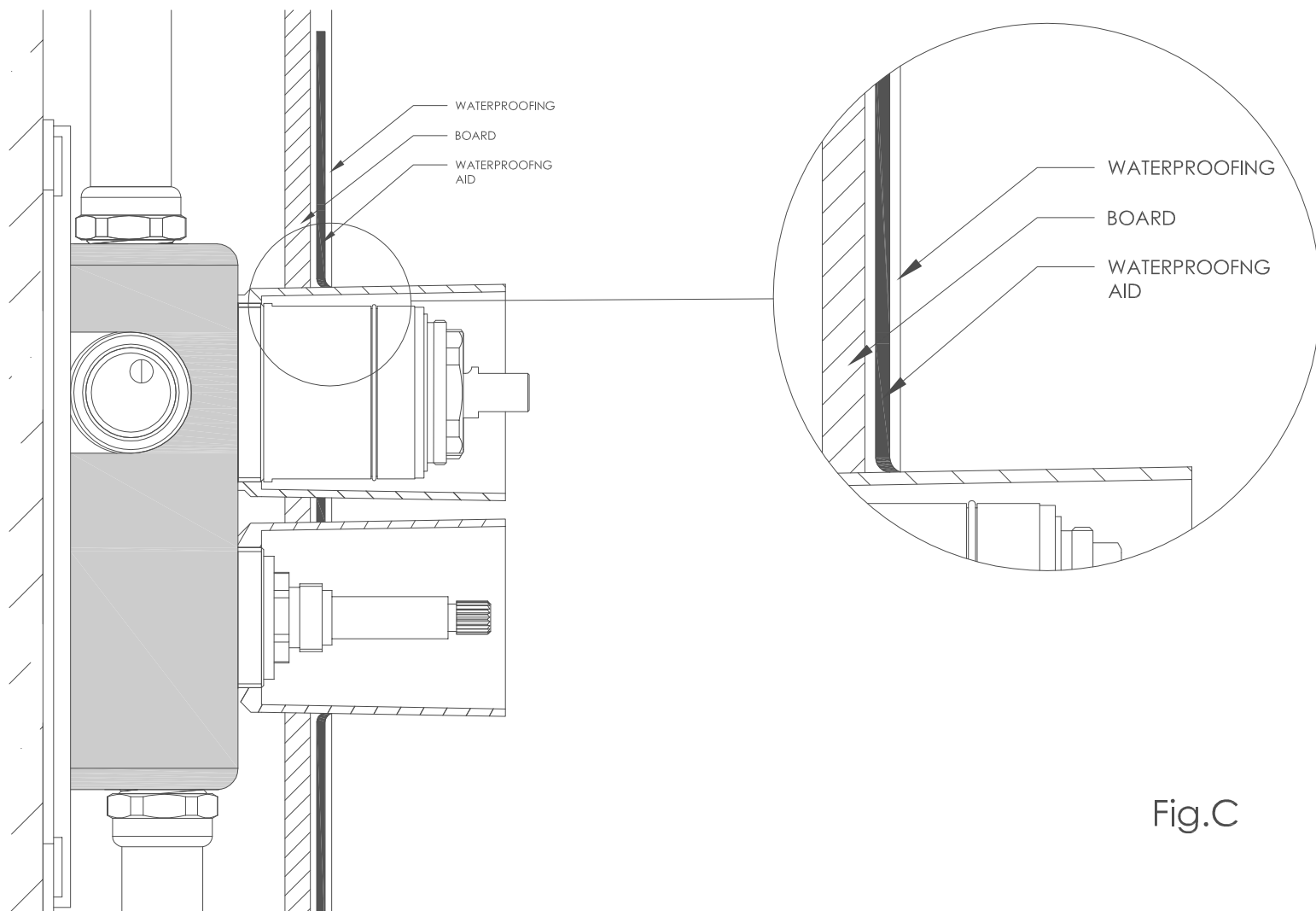

Fig.C

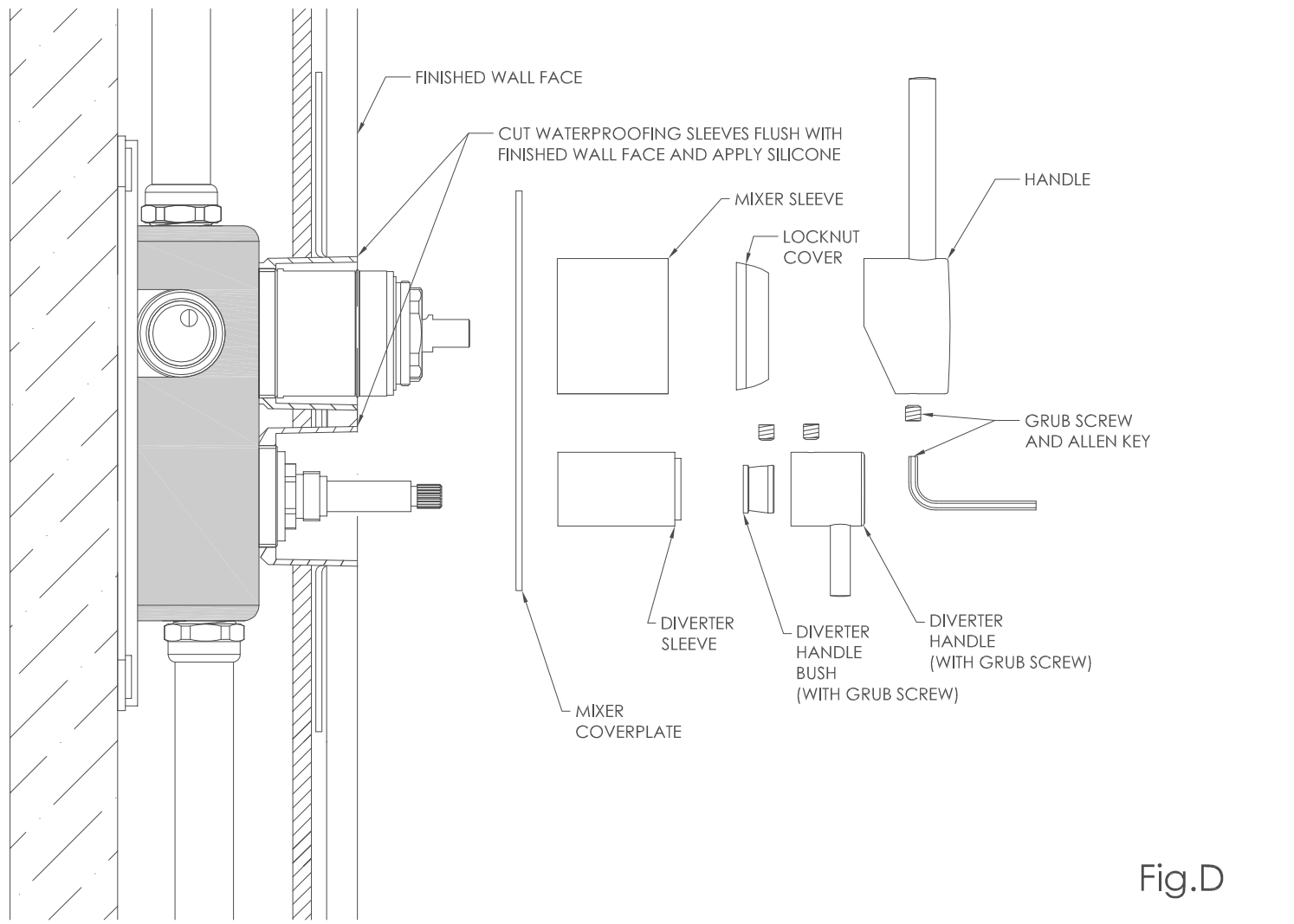

Fig.D