

Brodware

INDUSTRICA WALL SET WITH METAL LEVER

1.6728.80.0.XX

1.6728.58.0.XX: Flow controlled variant



PRODUCT DIMENSIONS:

Front view

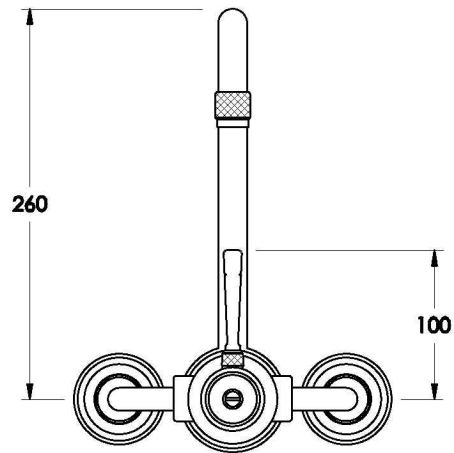

Side view:

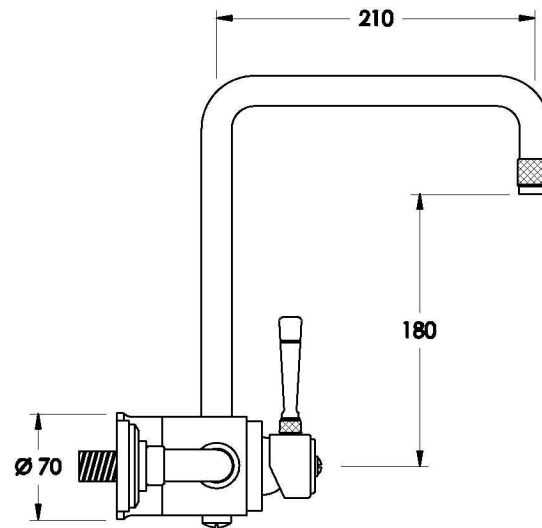

Top view:

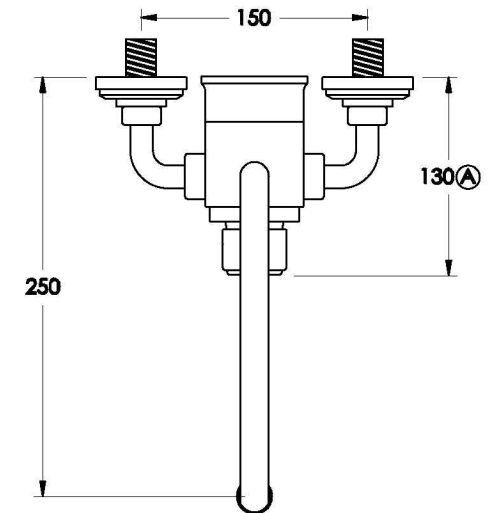

Note: $\frac{1}{2}$ " BSP female fittings required in the wall