

# BASIN & WALL MIXER INSTALLATION INSTRUCTIONS

---

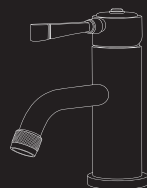
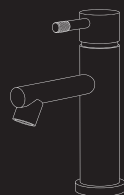
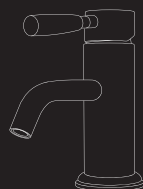

# IMPORTANT INFORMATION

---

- All tapware and showers to be installed by a licensed plumber and to Australian Standards. Fit tempering and pressure reduction valves where required. Flush water lines before fitment to avoid damage to valve.
- Water temperature is not to exceed 50°C as per AS3500
- Water pressure is not to exceed 500kPa as per AS3500
- Pressure difference: Hot - Cold water pressure difference is not to exceed 150kPa. This product is designed to work on high pressure systems only.
- This unit cannot be used for unpressurised storage heaters.



**ALL PLUMBING MUST BE TESTED BEFORE CONCEALING/SHEETING OFF AS PER AS3500**

## CHECK FOR CORRECT FUNCTION & MAINTENANCE

1. Pull lever – open (water flows)
2. Depress lever – closed
3. Turn lever clockwise – Cold water
4. Turn lever anticlockwise – Hot water

## MAINTENANCE & CARE (INCLUDING CARTRIDGE REPLACEMENT)

1. Shut off the hot and cold water supplies
2. Loosen the socket screw at the back or underside of the handle with a 2mm Allen key and pull off lever handle
3. Remove the metal cover cap below the lever handle
4. Remove the Hex Locknut below cover cap
5. Pull out the cartridge and base 'O' Ring Seal
6. Replace with a genuine Brodware cartridge. Care must be taken to ensure that the lower 'O' Ring Seal is located in the cartridge correctly.

# BASIN AND SINK MIXER INSTALLATION

---

1. To comply with Australian standards, stop cocks are to be installed below the tail pipes
2. Fit 'O' ring to mixer base
3. Fit the optional base ring or extension if required. This is not included as a standard.
4. Hole size to be  $\varnothing 35\text{mm}$  except 9302 or 9402 which is  $\varnothing 32\text{mm}$ .
5. Lower mixer into basin or counter top.
6. Fit the metal washer to underside of basin or counter top
7. Fit the brass nut to stud and tighten mixer to it's correct position.
8. Check for leaks and ensure the swivel spout is secured with a screw

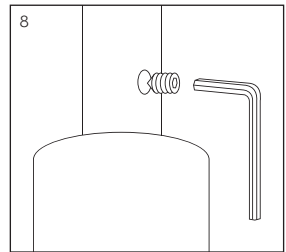
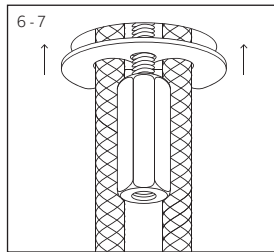
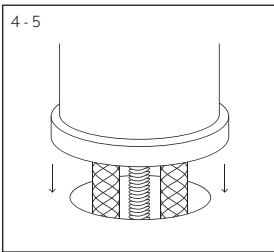
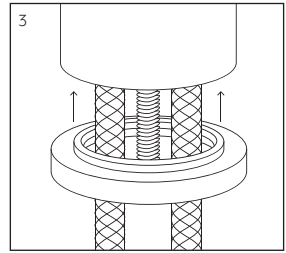
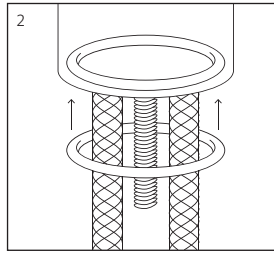
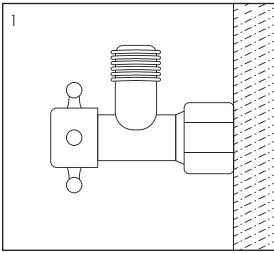

# SHOWERS

---

When installing wall showers ensure that the male connecting threads do not damage the flow controller.

# WALL MIXER

## INSTALLATION GUIDE

---

1. Remove the handle and trim and push protective sleeve over the body to protect from damage during tiling.
2. Install mixer to correct depth as shown in the drawing. It is most important that the finished wall location is determined.

Base of body to finished wall face (Length B)

Product	Max	Min
1.9348.00	70mm	45mm
1.9448.00	60mm	45mm
All other innwall mixers	77mm	45mm

When installing the mixer ensure that it is positioned the correct way (as per the markings on the body) with the hot water on the left and cold water on the right when viewed from an operating position.

Connect mixer using union connections (not nylon olives).

Ensure mixer is level and aligned correctly.

3. Because of the speed at which single lever mixers can be closed, they can accentuate water hammer if not properly installed. Before sheeting walls it is important that the system is checked for this.

If hammer is apparent, all possible measures are to be taken, including but not limited to, correct and secure fixing of pipework, keeping the length of the pipework on the outlet as short as possible and the fitting of outlets that have a high star rating.

4. Check operation and test for leaks before plastering or tiling and refit tiling sleeve. Seal around bodies to prevent water penetration into wall.
5. On completion of tiling remove tiling sleeve and fit dress ring. Fit handle and secure with grub screw.

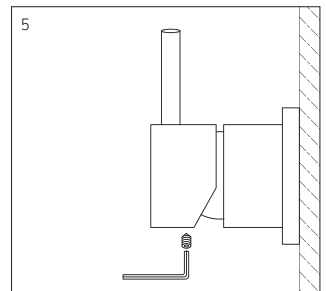
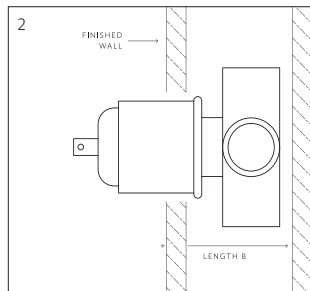
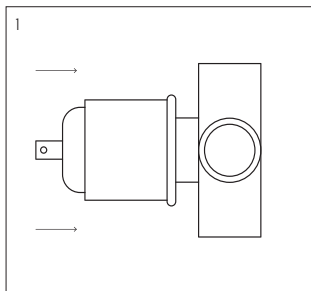

# 1.7505.05, 1.9805.05 AND YOKATO COMBINATION INSTALLATION GUIDE

---

## TO BE READ IN CONJUNCTION WITH WALL MIXER INFORMATION.

1. Seal and fit plug.
2. Fit and seal nipple then tighten nuts.
3. Trial fit the wall plate and ensure centre of mixer to nipple is correct and level before sheeting off.
4. Fix backing plate to wall.
5. Cut the nipple thread to length before fitting wall plate.
6. Tile or finish wall face.
7. City Que 1.9805.05. Plate to fit back to the shoulder of the nipple. Yokato 1.9305.05. The nipple screws in from the front. Screw till it bottoms out on the plate.
8. When fitting off lock handle and spout screws with allen key supplied.

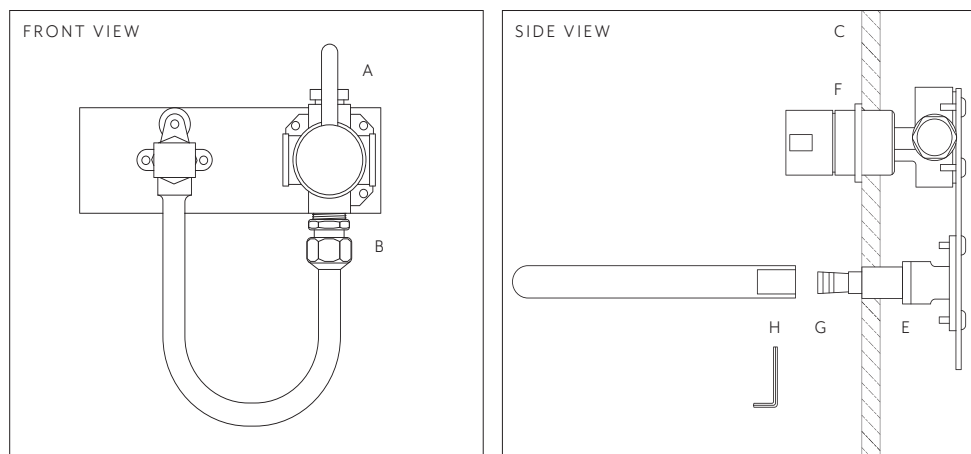

# FLOOR MOUNTED BATH/BASIN MIXER INSTALLATION GUIDE

---

## **TO BE READ IN CONJUNCTION WITH INFORMATION ON REVERSE.**

Note: Remote isolating valves must be fitted to enable ease of service if required.

1. Using 3/8" copper tubes supplied, rough in supply lines. Use the template supplied to ensure the correct spacing of tubes.
2. The two holes in the centre are for lining up the copper tube. The arrow points to the direction of the spout. The four outer holes are the markers for the mounting points to go through the floor. Discard the template disc at time of final fit off.
3. The tubes are to be clean and smooth with no external damage, with the top of the tubes clean cut and no external burrs. Ensure protection of tubes during building works.
4. The structure is to be sufficient to securely anchor the mixer and tubes.
5. When fitting off drill floor for fixings, ensure water lines are flushed to remove foreign particles. Push on flexible connectors to supply tubes.
6. Supply tubes to be 25-30mm above finished floor.
7. Water test before fixing down.
8. If the floor is not level, the adjustment screws in the floor mount can be adjusted to ensure the mixer is vertical.
9. Screw down dress flange.

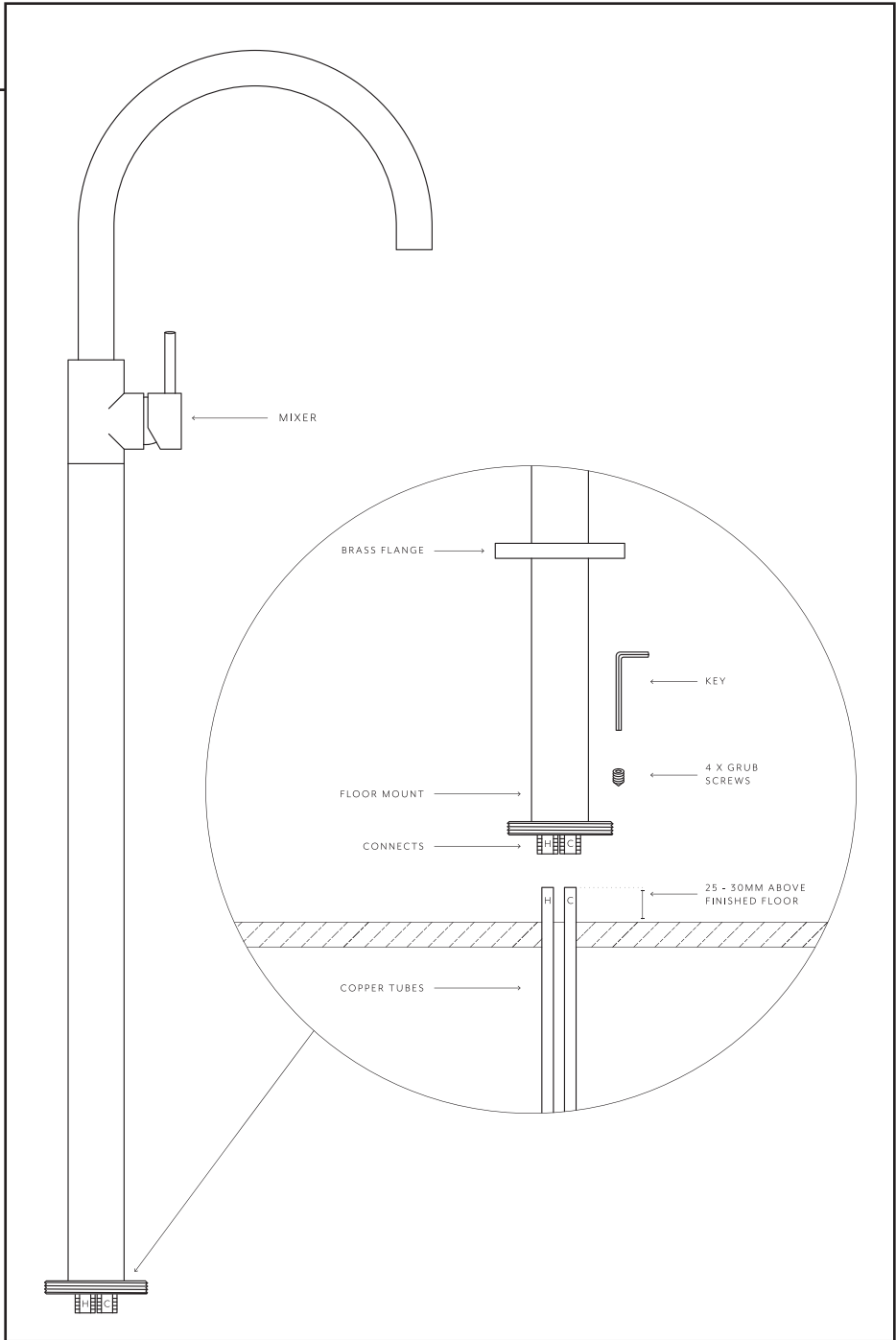

# 1.9913.00, 1.9914.00 AND 1.9813.00 FLOOR MOUNTED SHOWER INSTALLATION GUIDE

---

These instructions are to be read in conjunction with the basic installation card.

1. Using 3/8" copper tubes supplied, rough in supply lines. Use the template supplied to ensure the correct spacing of tubes. The two holes in the centre are for lining up the copper tube. The arrow points to the direction of the spout. The four outer holes are the markers for the mounting points to go through the floor. Discard the template disc at time of final fit off.
2. The tubes are to be clean and smooth with no external damage, with the top of the tubes clean cut and no external burrs. Ensure protection of tubes during building works.
3. The structure is to be sufficient to securely anchor the mixer and tubes.
5. When fitting off drill floor for fixings, ensure water lines are flushed to remove any foreign particles. Push on flexible connectors to supply tubes. Supply tubes to be 25-30mm above finished floor and centered 75mm from wall.
6. Water test before fixing down.
7. Remote isolating valves must be fitted to enable ease of service if required.
8. If the floor is not level, the adjustment screws in the floor mount can be adjusted to ensure the mixer is vertical.
9. Screw down dress flange.



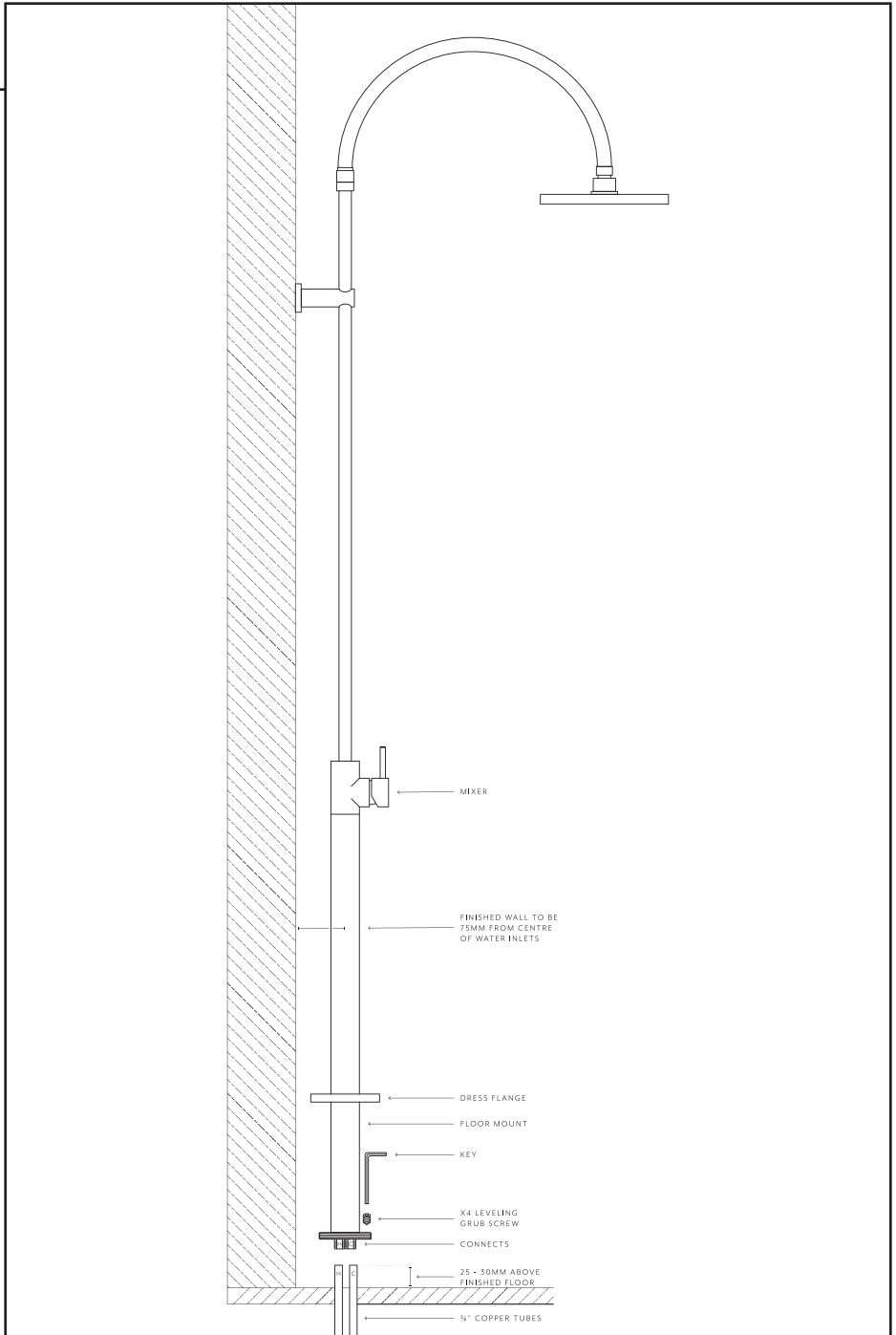

# 1.XX48.05 DIVERTER/MIXER INSTALLATION GUIDE

---

1. When installing the mixer, ensure that it is positioned correctly, with the mixer on the top side and the diverter on the bottom side.
2. Hot water is connected to the left, and the cold water is connected to the right, when viewed from the operating position.
3. When the diverter handle is rotated fully clockwise, water is diverted to the bottom port.
4. Anti-clockwise rotation of the handle diverts water to the top port.

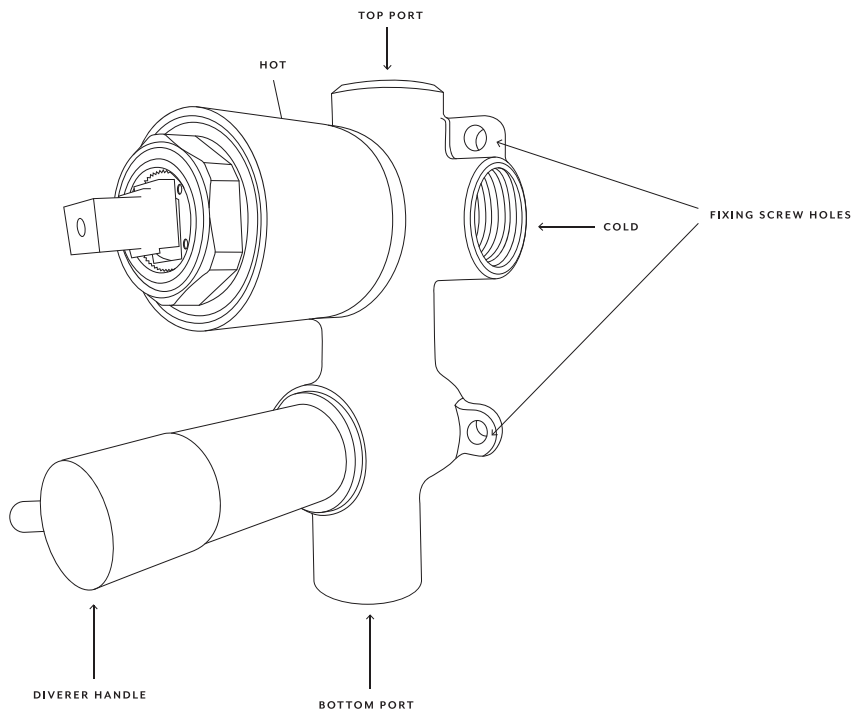

**Vogue** Spas & Bathrooms