

# Owner's Manual

## OFURO 1-TP

**Index**

Parts List

Installation Sample

Caution

Before you install

Dimension

## Parts List

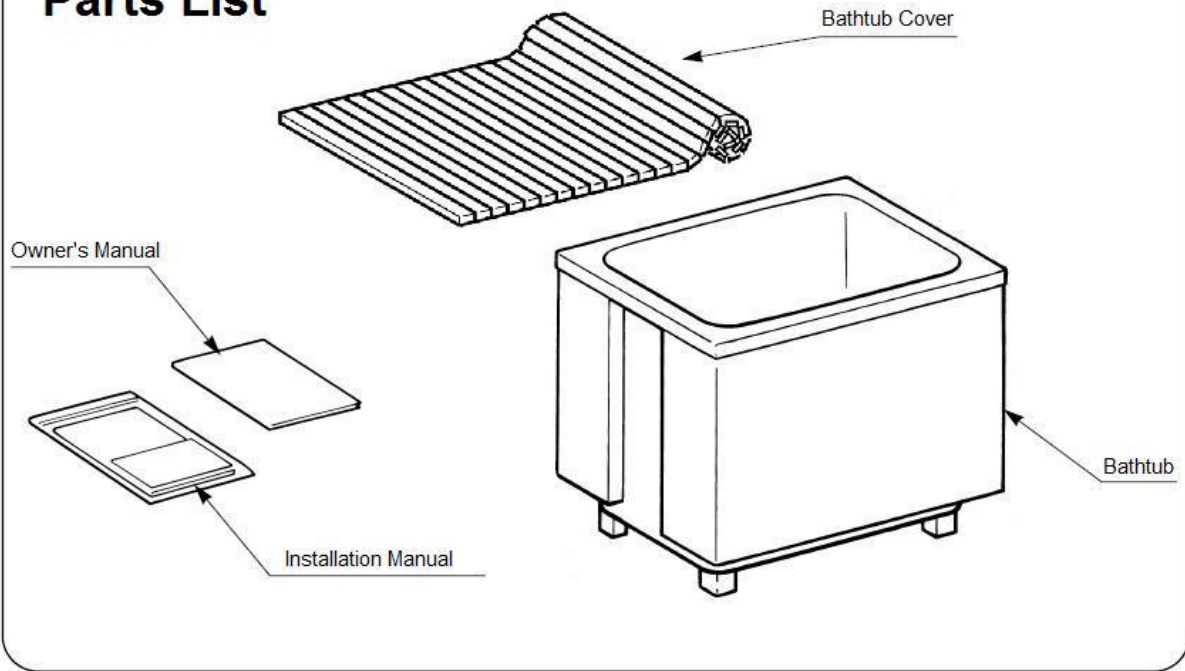

## Installation Sample

### Free Standing

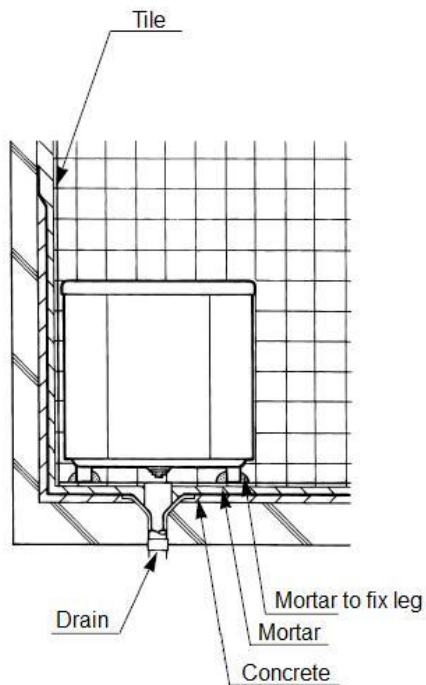

### Permanent Installation

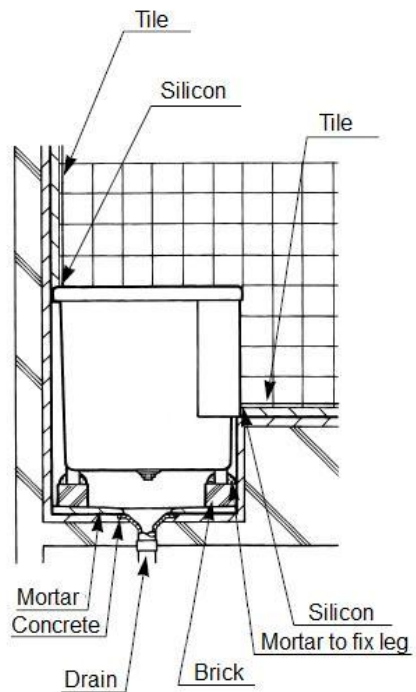

# Caution

- Cover bathtub by cardboard during installation.

Bathtub may be damaged or break.

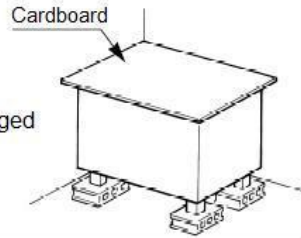

- Do NOT step on the bathtub or put ladder on the bathtub.

Bathtub may be damaged or break.

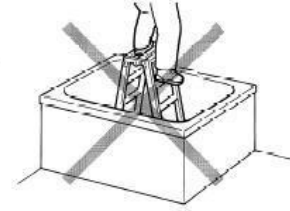

- Do NOT adhere mortar to the bathtub. To fix the bathtub, put mortar to ONLY legs of the bathtub.

Bathtub may be break due to excess pressure on the bottom.

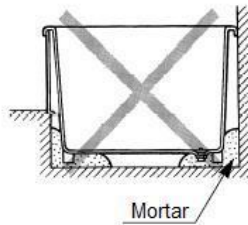

- Do NOT drop tools on the bathtub.

Bathtub may be damaged or break.

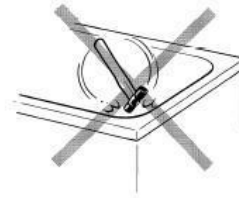

- Stay away torch or cigarettes from bathtub.

Bathtub may be damage or color change may be occur.

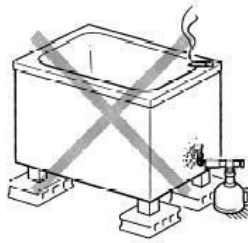

- Do NOT put heavy stuff on the bathtub.

Bathtub may be damaged or break.

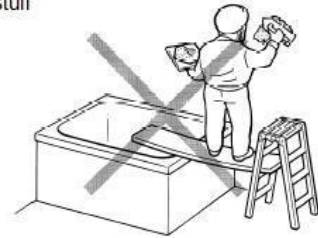

- Do NOT remove protection sheet on the surface until you finish installation.

Bathtub may be damaged or break.

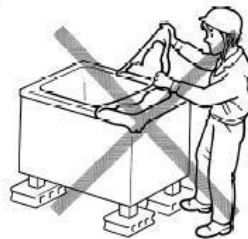

- Do NOT use cleaner for tile to bathtub.

Bathtub may be damage or color change may be occur.

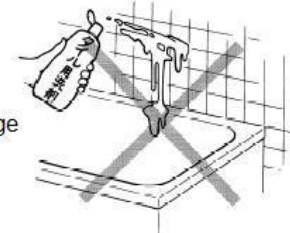

## Before you install

- Make sure there is no crack or damage on the bathtub.

If you find any damage, please contact dealer so soon as possible.



- Make sure there is enough space and people to carry bathtub. Do NOT drag or carry by one person.

Bathtub may be damaged or break.

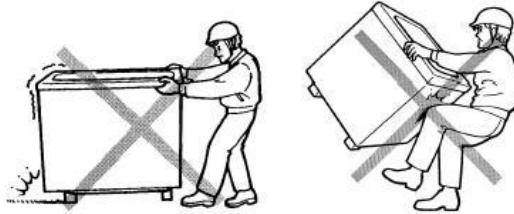

- Make sure the drain is properly tighten. It could be loosen during transport.

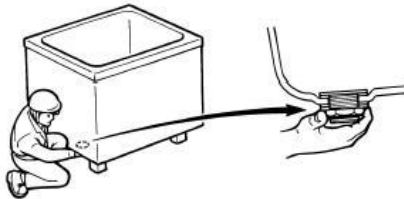

- Make sure there is no missing parts.

- Make sure how you install bathtub.

- Do NOT remove styro foam on the bottom and behind aprons.

## Dimension

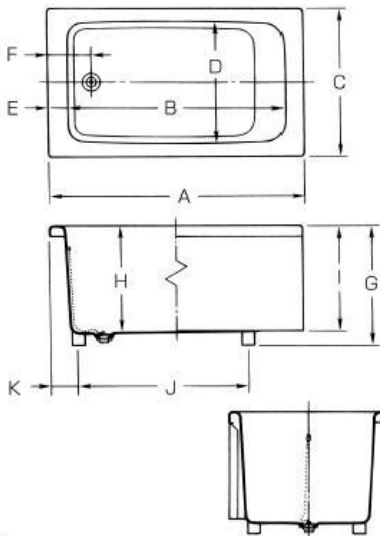

	A	B	C	D	E	F	G	H	I	J	K
Ofulo 1- TP	35.4	31.5	27.6	23.6	1.97	5.71	26.0	24.0	23.2	27.6	3.94