



Xentric
CUSTOM DRAPERY HARDWARE



*honesty
& dedication*
are our **principles**

When the finishing touch calls for a truly special design, we provide full-service made-to-order services for any product, from finials to rods to tiebacks in all sizes, shapes, finishes and materials.

Whether you have a custom blueprint design that's ready for production or a rough pencil sketch, our expert, friendly staff is equipped with solid technical knowledge and creative inspiration to help guide you from start to finish.

Your creative goals will be met, your item ready on time, and most importantly, your clients will be impressed with the look and feel of their enhanced surroundings.





Wrought Iron

- Rod Styles and Sizes 2
- Glass Finial Collection 3
- Contempo Finial Collection 4
- Manhattan Finial Collection 5
- Metropolis Finial Collection 6
- Urban Finials / Petite finials 7
- Traditional Finial Collection 8
- Royal Finial Collection 11
- Renaissance Collection 12
- Tiebacks / Swag Holders 14

Accessories & Brackets

- Corner Bracket, Rings, etc. 17
- Hand Forged Brackets 18
- Hand Crafted & Contempo Brackets 19
- Signature Brackets Manhattan, Urban & Regal... 20
- Urban & French Rods with Returns 22
- Urban Slim Collection 23
- Urban Slim Brackets & Bypass System 25

Plated Collections

27

Rod Styles, Monaco, Glass, Contempo, Manhattan, Urban Finials, Tiebacks, Accessories, Hand Crafted Brackets, Signature Brackets, Urban & French Rods with Returns, Urban Slim Rods, Urban Slim Finials, Urban Acrylic Rods & Urban Acrylic Finials.

Traversing Systems

42

Somfy Motorized Traverse System, Demi-Traverse Rods, Euro Traverse Rods.

Wood And Resin Collection, Artisan Rods

51

Wood Collection, Resin Collection, Cornices and Crowns, Artisan Rods, Swing Arms, Swift Program, Designer's Tools & Finishes.

rod styles



rod sizes

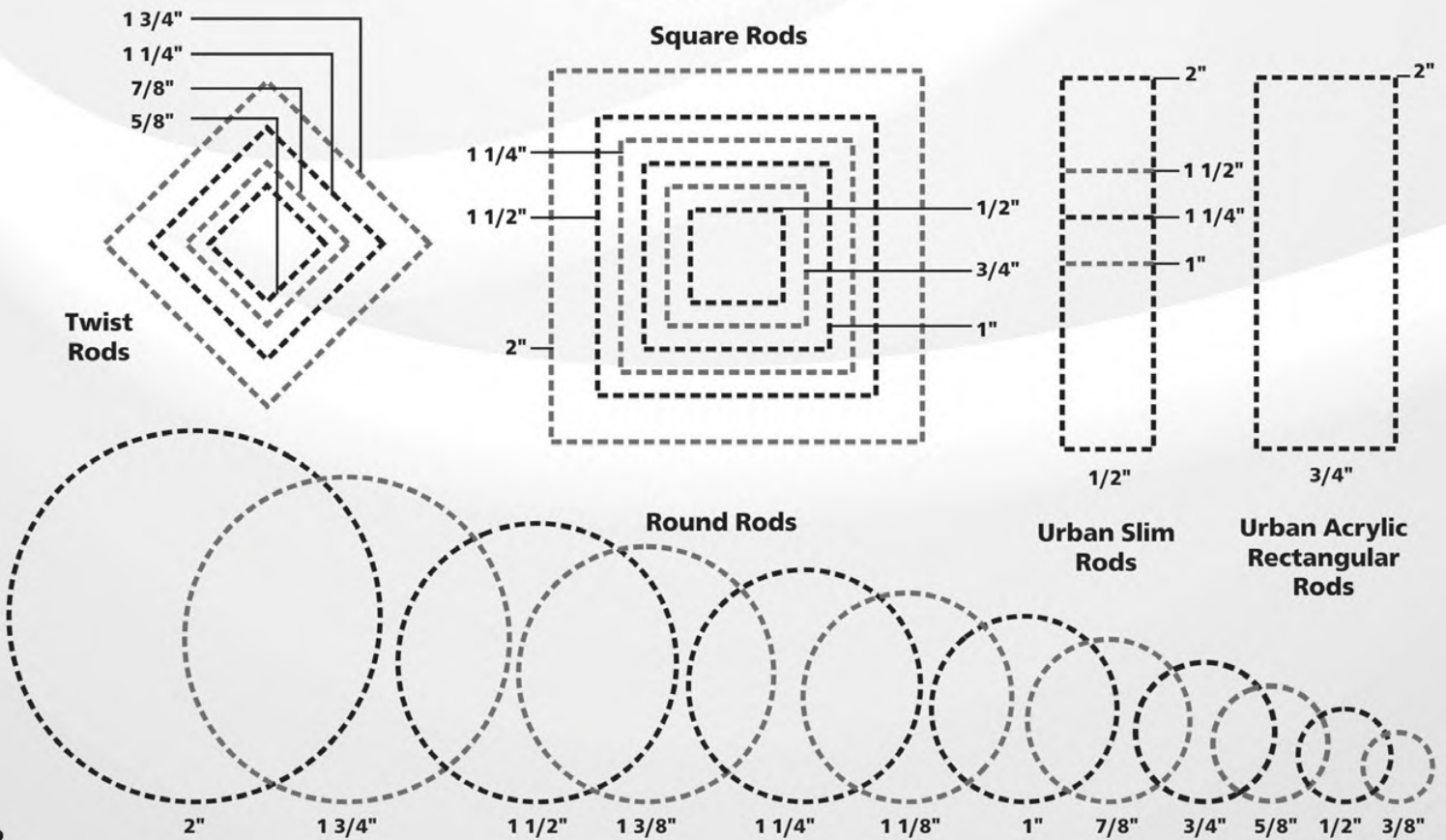

glass finial collection



contempo finial collection



manhattan finial collection



60
L 4" x H 1 3/4"
Verdy Vecchio: Grp3



61
L 3 1/4" x H 1 3/4"
Burned Brass: Grp3



62
L 2 1/4" x H 1 3/4"
Mystique: Grp2



63
L 3" x H 2"
Copper Vecchio: Grp2

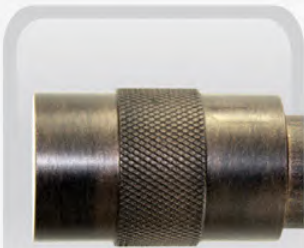

64
L 3" x H 2"
Old Bronze: Grp2



65
L 3" x H 2"
Raw Steel: Grp2



66
L 3" x H 2"
Dark Steel: Grp2



67
L 3" x H 2"
Gunmetal Blue: Grp3



68
L 3 1/4" x H 1 1/2"
Gold Vecchio: Grp2



69
L 3 1/4" x H 2 1/4"
Oiled Bronze: Grp2



70
L 3" x H 2"
Black Nickel: Grp2

• All finials can be utilized as tiebacks.



9
L 3 5/8" x H 2 1/2"
Gunmetal Blue: Grp3



10
L 3 1/2" x H 2 1/2"
Raw Steel: Grp2



14
L 3 1/4" x H 2 1/4"
Renaissance: Grp3



15
L 3 1/4" x H 2 1/2"
Black Nickel: Grp2



17
L 3 1/2" x H 2 1/2"
Cava: Grp2

metropolis finial collection



330
L 1 3/4" x H 2 1/4"
Mystique: Grp2



331
L 2 3/4" x H 2"
Dark Umber: Grp2



332
L 3 1/2" x H 1 3/4"
Old Bronze: Grp2



333
L 2 1/2" x H 1 3/4"
Oxide: Grp2



334
L 3" x H 2"
Verdy Vecchio: Grp3

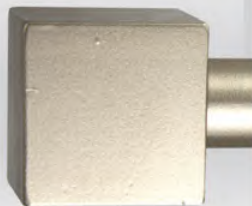

335
L 2" x H 2"
Cava: Grp2



336
L 2 1/2" x H 2"
Oiled Bronze: Grp2



337
L 2 3/4" x H 2"
Noir: Grp3



338
L 2 1/2" x H 2"
Enigma: Grp2



339
L 2 3/4" x H 2"
Heirloom: Grp2



341
L 3" x H 2"
Rustic: Grp3

• All finials can be utilized as tiebacks.



342
L 1/2" x H 2"
Merlot: Grp2



344
L 1/2" x H 2"
Copper Vecchio: Grp2



346
L 4" x H 3"
Burned Brass: Grp3

finials



urban finials

• All finials can be utilized as tiebacks.

179
L 2 5/8" X H 2"
Oiled Bronze: Grp2

184-Large
L 2 3/4" X H 3"
Cava: Grp2

185-Medium
L 2" X H 2"
Radiant Gold: Grp2

190-Large Hand Hammered
L 3" X H 3"
Oxide: Grp2

191
L 3" x H 1 1/2"
Heirloom: Grp2

192
L 3" x H 2"
Gold Vecchio: Grp2

Urban Slim Finials 680 to 687 are available for Urban Slim Rods 1" to 2" as well as Iron Round Rods from 1" to 2" Diameter.

680
L 5 1/4" X H 3"
Plume: Grp3

681
L 5 3/4" X H 2 3/4"
Plume: Grp3

682
L 4 1/2" X H 2 3/4"
Enigma: Grp2

683
L 4 3/4" X H 3 1/4"
Enigma: Grp2

684
L 4 1/2" X H 2 1/2"
Gunmetal Blue: Grp3

685-Small
L 4 1/2" X H 4"
Gunmetal Blue: Grp3

686
L 4 1/2" X H 3 3/4"
Heirloom: Grp2

687
L 4 3/4" X H 3 1/4"
Heirloom: Grp2

petite finials

80
L 4 5/8" x H 3"
White: Grp2

81
L 4 1/2" x H 2 1/2"
Old Bronze: Grp2

82
L 4 1/2" x H 1 3/8"
Dusty Gold: Grp2

83
L 4 1/4" x H 2"
Dark Umber: Grp2

84
L 3" x H 1 3/8"
Olive: Grp3

85
L 1 5/8" x H 1 1/8"
Gold Vecchio: Grp2



traditional finial collection



100
Left/Right
L 4 1/2" x H 3 1/4"
Dark Umber: Grp2



101
L 6 1/2" x H 5"
Enigma: Grp2



103
L 3 1/2" x H 2"
White: Grp2



104
L 4 1/4" x H 3 3/4"
Mystique: Grp2



105
L 3 1/4" x H 3"
Old Bronze: Grp2



106
L 5 1/4" x H 4"
Gold Vecchio: Grp2



107
L 4" x H 1"
Red Oxide: Grp2



108
L 2 1/2" x H 2"
Radiant Gold: Grp2



109
L 5" x H 2 3/4"
Heirloom: Grp2



110
L 3 1/4" x H 2 1/4"
Olive: Grp3



111
L 4" x H 1"
Dark Steel: Grp2



112
L 7 1/2" x H 4"
Dusty Gold: Grp2



113
L 5" x H 2"
Heirloom: Grp2



114
L 2" x H 2 1/4"
Mystique: Grp2

• All finials can be utilized as tiebacks.

finials



traditional finial collection

• All finials can be utilized as tiebacks.



115
L 3 1/2" x H 2 1/2"
White: Grp2



116
L 7 1/2" x H 4"
Merlot: Grp2



117
L 6" x H 3 1/4"
Gold Vecchio: Grp2



118
L 4" x H 2 1/4"
Rusted Black: Grp3



119
L 5 1/4" x H 2 3/4"
Dark Umber: Grp2



120
L 4 3/4" x H 3"
Copper Vecchio: Grp2



121
L 7 1/2" x H 2 1/2"
Cava: Grp2



122
Left/Right/Hand Crafted
L 11 1/2" x H 11"
Olive: Grp3



123
Left/Right/Hand Crafted
L 4 1/2" x H 4 3/4"
Oiled Bronze: Grp2



124
Left/Right/Hand Crafted
L 5 1/4" x H 9 1/2"
Oiled Bronze: Grp2



125
Hand Crafted
L 5 1/2" x H 7 1/2"
Enigma: Grp2

130
L 2 1/4" x H 1 1/4"
Vintage: Grp3



126
L 1 3/4" x H 1 1/4"
Black Nickel: Grp2



128
L 5 1/4" x H 2 1/2"
Gold Vecchio: Grp2



129
L 2 3/4" x H 1 1/2"
Merlot: Grp2



finials

traditional finial collection



131
L 4 3/4" x H 3"
Plume: Grp3



132
L 5 1/2" x H 3"
Flare: Grp3



133-3"
Hand Hammered
3" Diameter
Old Country: Grp3



134-2"
2" Diameter
Burned Brass: Grp3



135
3" Diameter
Noir: Grp3



136
L 6" x H 3"
Verdy Vecchio: Grp3



137
L 5" x H 2 1/2"
Renaissance: Grp3



138
L 3" x H 3"
Burnt Sienna: Grp3



139
L 3" x H 3"
Tarnished Brown: Grp3

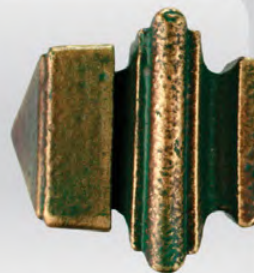

140
L 2 1/2" x H 2 1/2"
Renaissance: Grp3



141
L 2 1/4" x H 2 1/4"
Plume: Grp3



142
L 3/4" x H 2"
Verdy Vecchio: Grp3

• All finials can be utilized as tiebacks.



143
L 9" x H 5"
Burned Brass: Grp3



144
L 4" x H 1 1/2"
Flare: Grp3



145
L 5" x H 3 1/2"
Burned Brass: Grp3

royal finial collection



165
L 5" x H 3 3/4"
Verdy Vecchio: Grp3



166
L 5" x H 3 3/4"
Plume: Grp3



167
L 7" x H 2 1/2"
Vintage: Grp3



168
L 4 1/2" x H 2 1/2"
(Glass finial not included on size)
Heirloom: Grp2



169
L 4 1/2" x H 3"
Gold Vecchio: Grp2



170
L 3 3/4" x H 2"
Oiled Bronze: Grp2



171
L 4 3/4" x H 3"
Oxide: Grp2



172
L 3 1/4" x H 2 1/8"
Vintage: Grp3



173
L 3 1/4" x H 2 1/2"
Old Bronze: Grp2



174
L 4" x H 2"
Black Nickel: Grp2



175
L 5 1/2" x H 2 1/4"
Noir: Grp3



178
L 4" x H 3 1/2"
Dark Umber: Grp2

176
L 5 1/2" x H 2 1/2"
Burnt Sienna: Grp3

177
L 5 1/2" x H 3 1/2"
Rustic: Grp3

• All finials can be utilized as tiebacks.

renaissance finial collection



102
Hand Forged
L 4 3/4" x H 5 1/2"
Oxide: Grp2



146
Hand Forged
L 6 1/2" x H 7"
Vintage: Grp3



148
Hand Crafted/Shown Left
L 6" x H 5 1/4"
Tarnished Brown: Grp3



150-3"
Hand Crafted/Shown Left
L 4 1/2" x H 4 1/2"
Burnt Sienna: Grp3



152
Shown Left
L 9 1/2" x H 6"
Noir: Grp3



153
Shown Left
L 9 1/2" x H 11"
Renaissance: Grp3



154
Hand Forged/Shown Left
L 6 1/2" x H 10"
Plume: Grp3



155
Hand Forged
L 6" x H 5 1/4"
Vintage: Grp3



156
Hand Forged
L 5 1/2" x H 5 1/4"
Old Country: Grp3



157
Hand Forged
L 6 1/2" x H 4 1/4"
Verdy Vecchio: Grp3



158
Hand Forged
L 6 1/2" x H 6 1/2"
Flare: Grp3



159
Hand Forged/Shown Left
L 6 3/4" x H 6"
Tarnished Brown: Grp3



160
Hand Forged/Shown Left
L 11 1/2" x H 6 1/2"
Radiant Gold: Grp2



161
Hand Forged
L 7" x H 5"
Oiled Bronze: Grp2



162
Hand Forged
L 7 1/2" x H 4"
Old Bronze: Grp2



163
Hand Crafted/Shown Left
L 6 1/2" x H 3"
Oiled Bronze: Grp2

• All finials can be utilized as tiebacks.

renaissance finial collection



164
L 5 3/4" x H 8 1/4"
Mystique: Grp2



430
Hand Forged, Shown Left
L 8 1/2" x H 6 1/2"
Renaissance: Grp3



431
Hand Forged, Shown Left
L 8" x H 5"
Burned Brass: Grp3



432
Shown Left
L 8 1/4" x H 8 1/2"
Mystique: Grp2



433
Shown Left
L 5 1/2" x H 11"
Flare: Grp3



434
L 8 1/2" x H 8"
Oiled Bronze: Grp2



435
Shown Left
L 8 3/4" x H 7"
Verdy Vecchio: Grp3



436
Shown Left
L 8" x H 7 1/2"
Vintage: Grp3



437
Hand Forged
L 5 3/4" x H 6 1/4"
Enigma: Grp2



438
Hand Forged
L 5 1/2" x H 5 1/2"
Tarnished Brown: Grp3



439
Hand Forged
L 7" x H 5 1/4"
Oxide: Grp2



440
Hand Forged
L 6 1/2" x H 5"
Rusted Black: Grp3

• All finials can be utilized as tiebacks.

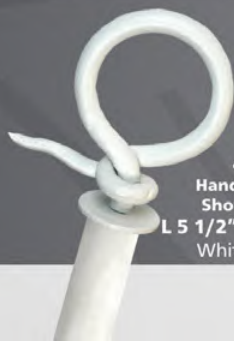

441
Hand Forged
Shown Left
L 5 1/2" x H 4 1/4"
White: Grp2



442
Hand Forged
Shown Left
L 3 1/2" x H 2 1/2"
Flare: Grp3



443
Hand Forged
Shown Left
L 5" x H 4 3/4"
Old Country: Grp3



444
Hand Forged
L 8 1/4" x H 5 1/2"
Rusted Black: Grp3



445
Hand Forged
L 7" x H 9"
Renaissance : Grp3

tiebacks



700
L 4" x H 9 1/2"
Renaissance: Grp3



701
L 3" x H 6 1/4"
Burned Brass: Grp3



702
L 3 3/4" x H 6"
Noir: Grp3



703
L 6" x H 6"
Old Country: Grp3



704
L 4" x H 5 3/4"
Plume: Grp3



705
L 4 1/2" x H 4 1/2"
Verdý Vecchio: Grp3



706
L 3 1/2" x H 6 1/4"
Burned Brass: Grp3



707
L 2 1/2" x H 6 1/4"
Enigma: Grp2



708
L 3 3/4" x H 4"
Burnt Sienna: Grp3



709
3 1/2" Diameter
Tarnished Brown: Grp3



710
L 2 3/4" x H 4 3/4"
Old Country: Grp3



711
3" Diameter
Flare: Grp3



712
3 1/2" Diameter
Plume: Grp3

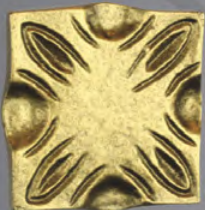

713
L 3 1/2" x H 3 1/2"
Burned Brass: Grp3



714
Shown Right
L 8 1/2" x H 4"
Burned Brass: Grp3



715
L 5" x H 4 1/2"
Vintage: Grp3

tiebacks

T



716
L 4 1/2" x H 4 1/2"
Burned Brass: Grp 3



718
3 1/2" Diameter
Burnt Sienna: Grp 3



720
L 5" x H 2 1/2"
Renaissance: Grp 3



723
L 4 1/2" x H 6 1/4"
Noir: Grp 3



724
3/4 Diameter
Old Bronze: Grp 2



725
Shown Right
L 13" x H 6 1/4"
Renaissance: Grp 3



726
Shown Right
L 4 1/2" x H 3 1/4"
Vintage: Grp 3



727
Shown as U-Shaped
L 4" x H 1"
Burnt Sienna: Grp 3



729
Hand Forged
L 6 1/2" x H 13"
Burnt Sienna: Grp 3



728
Shown as U-Shaped
L 4" x H 1"
Flare: Grp 3



730
4 1/2" Diameter
Tarnished Brown: Grp3



731
7" Diameter
Burned Brass: Grp3



732
L 4 1/2" x H 4 1/2"
Dusty Gold: Grp2



733
3 3/4" Diameter
Mystique: Grp2



734
4 1/2" Diameter
Old Bronze: Grp2

• All tiebacks can be utilized as finials.

tiebacks



735
L 6 1/2" x H 7 1/2"
Gold Vecchio: Grp2



736
L 6" x H 4 3/4"
Radiant Gold: Grp2



737
5" Diameter
Olive: Grp3



738
L 4" x H 6 1/2"
Merlot: Grp2



739
L 3 1/4" x H 5 1/4"
Heirloom: Grp2



740
L 5 3/4" x H 3"
Copper Vecchio: Grp2



741
L 3 1/2" x H 5 1/2"
Black Nickel: Grp2



742
3 1/2" Diameter
Red Oxide: Grp2



743
4" Diameter
Gold Vecchio: Grp2



744
3 1/4" Diameter
Old Bronze: Grp2



745
3" Diameter
Radiant Gold: Grp2



752
L 2 1/4" x H 2 1/4"
Old Bronze: Grp2

contempo tiebacks & contempo batons



790
3" Diameter
Dark Steel: Grp2



792
3" Diameter
Black Nickel: Grp2



794
L 3 1/2" x H 3 1/2"
Raw Steel: Grp2



791
3" Diameter
Gold Vecchio: Grp2



793
3" Diameter
Copper Vecchio: Grp2



795
L 3 1/2" x H 3 1/2"
Raw Steel: Grp2



620
L 3 1/2" x H 5/8
Gold Vecchio: Grp2



621
L 3 1/2" x H 5/8
Burned Brass: Grp3



• All tiebacks can be utilized as finials.

brackets

All brackets available in Standard 3" and 6" Projection as well as Custom Projections.

hand forged brackets



250
Hand Forged
1/2" Wide
Burnt Sienna: Grp3



251
Hand Forged
Flare: Grp3



252
Hand Forged
Enigma: Grp2



252-D
Hand Forged Double
Bracket
3" and 6" Projection
Enigma: Grp2



254
Hand Forged
Oiled Bronze: Grp2



255-D
Hand Forged
Double Bracket
3" and 6" Projection
Tarnished Brown: Grp3



305
Hand Forged
Verdy Vecchio: Grp3



306
Hand Forged
White: Grp2

decorative brackets



200
L 4" x H 8 1/2"
Rustic: Grp3



202
L 4 1/2" x H 2 1/2"
Burned Brass: Grp3



203
L 2" Diameter
Flare: Grp3



204
L 2 1/4" x H 3 1/2"
Tarnished Brown: Grp3



206
L 4 1/2" x H 3 1/4"
Shown Right
Renaissance: Grp3



207-3
Brown: Grp1



207-H
Horizontal Bracket
Brown: Grp1



209-3
Brown: Grp1



209-H
Horizontal Bracket
Brown: Grp1

hand crafted brackets *brackets*

304 brackets

All brackets available in standard 3" and 6" projection as well as custom projections for any rod style.



304-SP
Short Projection
1" Clearance



304-3
3" Projection



304-6
6" Projection

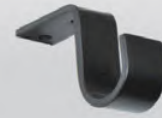

304-C
Ceiling Bracket



304-H
Horizontal Bracket



304-TS
Top Support



304-WS
With Support



304-D
Double Bracket
3" and 6" Projection

* All 304 Brackets shown in Black Grp: 1.

slim 304 brackets

All brackets available in standard 3" and 6" projection as well as custom projections for any rod style.



S304-SP
Short Projection
1" Clearance



S304-3
3" Projection
Shown for Square Rod



S304-6
6" Projection



S304-C
Ceiling Bracket



S304-H
Horizontal Bracket



S304-TS
Top Support
Shown for Square Rod



S304-WS
With Support



S304-D
Double Bracket
3" and 6" Projection

* All Slim 304 Brackets are made out of 3/4" Wide Heavy Gauge material, shown in Light Brown Grp: 1.

contempo brackets

All brackets available in standard 3" and 6" projection as well as custom projections for any rod style.



301-3
3" Projection



302-3
Invisible Screws
3" Projection



301-RECT-3
3" Projection



302-RECT-3
Invisible Screws
3" Projection



301-D
Double Bracket
3" and 6" Projection



302-D 3D
Invisible Screws
Double Bracket
3" and 6" Projection



301-RECT D
Double Bracket
3" and 6" Projection



302-RECT D 3D
Invisible Screws
Double Bracket
3" and 6" Projection

* All Contempo Brackets shown in Brown Grp: 1.

manhattan brackets

All brackets available in standard 3" and 6" projection as well as custom projections for any rod style.



*Manhattan Brackets 521 and 522 Styles with Invisible Screws, all Brackets shown in Cava Grp: 2.

urban brackets invisible screws

All brackets available in standard 3" and 6" projection as well as custom projections for any rod style with invisible Screws.

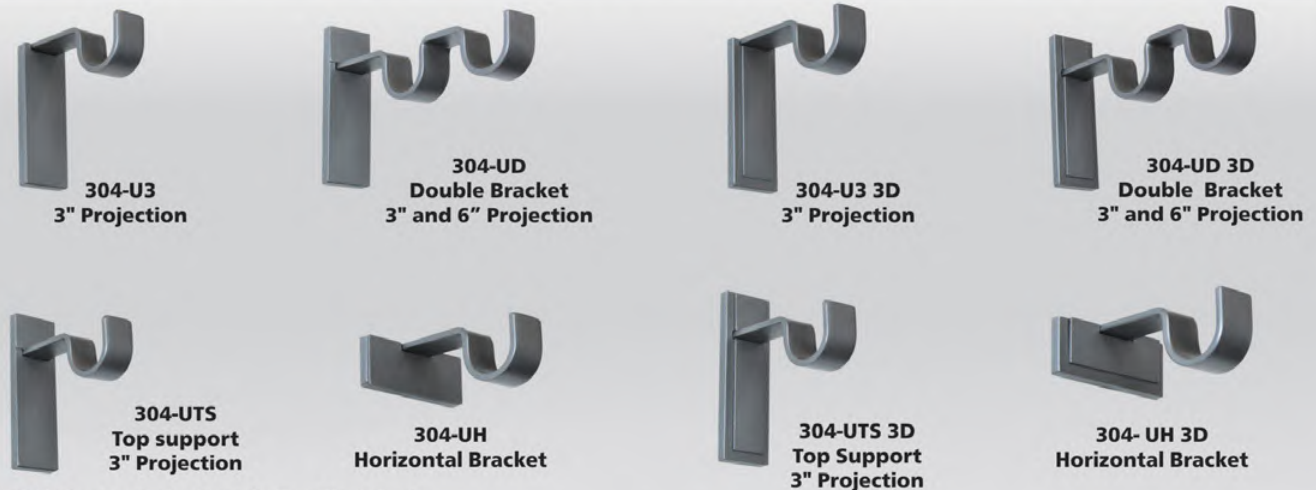

*All Urban Brackets shown in Raw Steel Grp: 2.

slim urban brackets invisible screws

All brackets available in standard 3" and 6" projection as well as custom projections for any rod style with Invisible Screws.



*All Slim 304 Brackets are made out of 3/4" Wide Heavy Gauge material, shown in Radiant Gold Grp: 2.

signature brackets



regal brackets

All Regal Brackets are available as Standard 3" Projection for Round Rods from 3/4" to 1 1/2" only, with Invisible Screws.
All Regal Brackets are available in Custom Projections.

Mix and Match any Bracket Arm with any Mounting Plate to create your Personalized Bracket.



*All Regal Top Support Brackets shown with Mounting Plate "D" in Burned Brass Grp: 3.
*TS : Top Support.



*All Regal Brackets shown with Mounting Plate "B" in Heirloom Grp: 2.
*For Regal Mounting Plate options "A", "B", "C" & "D" please see page 37.

regal 304 brackets

All brackets available in Standard 3" and 6" Projection as well as Custom Projections for any Rod style with Invisible Screws.

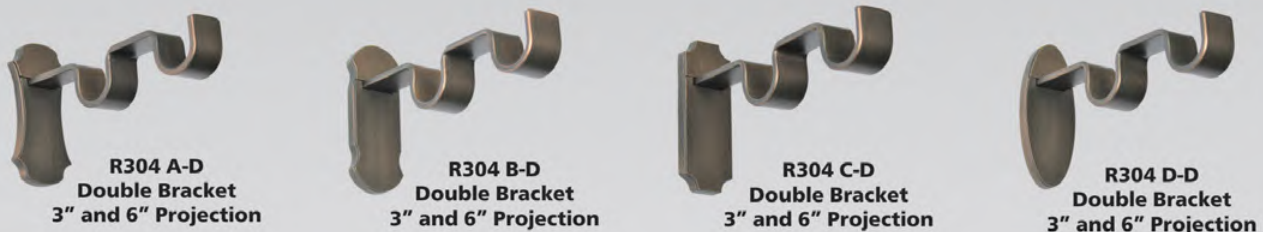
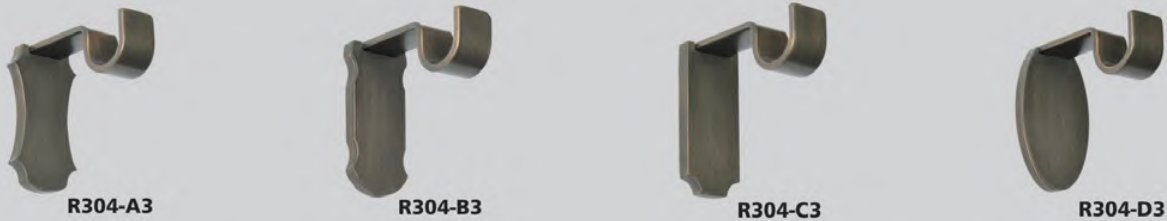

*All Regal 304 Brackets shown in Verdy Vecchio Grp: 3.
*TS: Top Support

urban and french rods with returns

regal mounting plates

All Regal Mounting Plates with Invisible Screws can be utilized with Urban & French Rods with Returns.



926-RA
Shown with
French Rod



French Rod Style
Shown as Single Rod
with Mounting Plates
926-RB and 926-RA



926-RD
Top Support
Shown with French Rod



926-RB
Top Support
Shown with French Rod



926-RC
Shown with
French Rod



926-RE
Shown with
French Rod



926-RF
Top Support
Shown with French Rod



926-RG
Shown with
French Rod



926-RH
Top Support
Shown with French Rod

*All Regal Mounting Plates are shown in Satin Silver: Grp 2.

urban mounting plates

All Urban Mounting Plates can be utilized with Urban & French Rods with Returns.

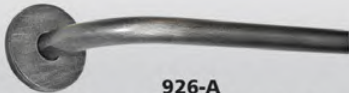

926-A
Shown with French Rod
with Invisible Screws



926 Urban Rod Style shown as Double Rod
3" and 6" Projection with Mounting Plates 926-D
Oiled Bronze: Grp2



926-D
Top Support Shown with
Square French Rod

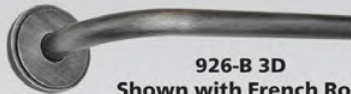

926-B 3D
Shown with French Rod
with Invisible Screws

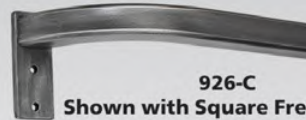

926-C
Shown with Square French Rod



926-E
Shown with French Rod
with Invisible Screws



926-F
Top Support Shown
with French Rod
with Invisible Screws



926-G 3D
Shown with
Square Urban Rod
with Invisible Screws



926-H 3D
Top Support Shown
with Square Urban Rod
with Invisible Screws

*All Urban Mounting Plates shown in Black Nickel: Grp 2.

traditional mounting plates

All Traditional Mounting Plates can be utilized with Urban & French Rods with Returns



926 French Rod Style shown as Double Rod
shown with 926-Mounting Plates
Oiled Bronze: Grp2



926-Mounting Plate
Black: Grp 1



926-1 1/4" French Rope Rod Style
Shown with 926-Mounting Plates
Black Nickel: Grp2



926-SQ
Shown with French Square Rod
Brown: Grp 1



926-SQ
Shown with French
Square Hammered Rod
Brown: Grp 1



926-207
Shown with French Hand
Hammered Rod
Brown: Grp 1



926-209
Shown with French Hand
Hammered Rod
Brown: Grp 1

urban slim collection

urban slim return rods

Urban Slim Returns Rods are available on 1", 1 1/4", 1 1/2" and 2".



952-Urban Slim Return Rod
Shown in 1 1/4" with Mounting Plates
952-F and 952-E
Oiled Bronze: Grp2



508 Urban Slim Ring
Black: Grp 1



952-C
Shown in 1" Rod



952-D
Top Support
Shown in 1" Rod



952-E 3D
Shown in 1 1/4" Rod



952-F 3D
Top Support
Shown in 1 1/4" Rod



952-G
Shown in 1 1/2" Rod



952-H
Top Support
Shown in 1 1/2" Rod

*Urban Slim Mounting Plate Styles 952-E to 952-H with Invisible Screws shown in Oiled Bronze: Grp 2.

urban slim rods

Urban Slim Rods are available on 1", 1 1/4", 1 1/2" and 2".



951-2" Urban Slim Rod
Shown with Finials 646 and 647
Merlot: G2

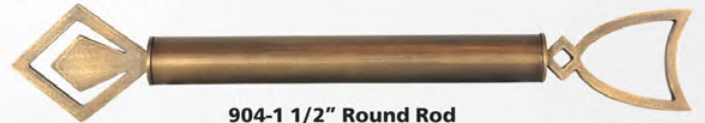

904-1 1/2" Round Rod
Shown with Finials 686 and 687 (see page 24)
Heirloom: G2

urban slim finials

Urban Slim Finials 640 to 647 are only available for 2" Urban Slim Iron Rods.



640
L 4 1/4" X H 2"
Burned Brass: Grp3



641
L 4 1/4" X H 2"
Burned Brass: Grp3



642
L 3 3/4" X H 2"
Dark Umber: Grp2



643
L 4 1/4" X H 2"
Dark Umber: Grp2



644
L 3 3/4" X H 2"
Mystique: Grp2



645
L 4 1/4" X H 2"
Mystique: Grp2



646
L 3 3/4" X H 2"
Merlot: Grp2



647
L 3 3/4" X H 2"
Merlot: Grp2

urban slim finials

Urban Slim Finials 680 to 687 are available for Urban Slim Rods 1" to 2" as well as Iron Round Rods from 1" to 2" Diameter.



680
L 5 1/4" X H 3"
Plume: Grp3



681
L 5 3/4" X H 2 3/4"
Plume: Grp3



682
L 4 1/2" X H 2 3/4"
Enigma: Grp2



683
L 4 3/4" X H 3 1/4"
Enigma: Grp2



684
L 4 1/2" X H 2 1/2"
Raw Steel: Grp2

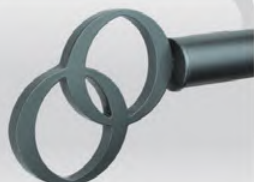

685-Small
L 4 1/2" X H 4"
Raw Steel: Grp2

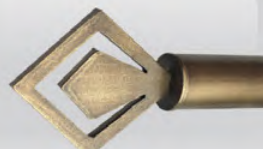

686
L 4 1/2" X H 3 3/4"
Heirloom: Grp2



687
L 4 3/4" X H 3 1/4"
Heirloom: Grp2

urban acrylic rods

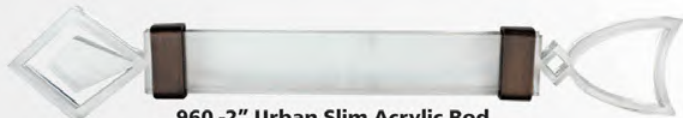

960-2" Urban Slim Acrylic Rod
Shown with Finials A686 and A687
Oiled Bronze: Grp2



961-1 1/2" Urban Acrylic Round Rod
Shown with Finials A682 and A683 with
Metal Silhouette.
Raw Steel: Grp2

urban slim acrylic finials

Urban Slim Acrylic Finials A640 to A647 are available with Optional Metal Silhouette for 960-2" Urban Slim Acrylic Rod only.

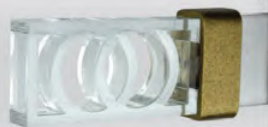

A640
L 4" X H 2"
Burned Brass : Grp3



A641
L 4" X H 2"
Burned Brass : Grp3



A642
L 3 1/2" X H 2"
Shown with Metal Silhouette
Burned Brass : Grp3



A643
L 4" X H 2"
Shown with Metal Silhouette
Satin Silver : Grp2



A644
L 3 1/2" X H 2"
Shown with Metal Silhouette
Burned Brass : Grp3



A645
L 4" X H 2"
Shown with Metal Silhouette
Satin Silver : Grp2



A646
L 3 1/2" X H 2"
Raw Steel: Grp2



A647
L 3 1/2" X H 2"
Raw Steel: Grp2

urban slim collection

urban acrylic finials

Urban Slim Acrylic Finials A680 to A687 are available with Optional Metal Silhouette for Urban Acrylic rods and Round Iron Rods 1 1/4" to 2".

 <p>A680 L 5 1/2" X H 3" Oiled Bronze: Grp2</p>	 <p>A681 L 6" X H 2 3/4" Oiled Bronze: Grp2</p>	 <p>A682 L 4 1/4" X H 2 3/4" Shown with Metal Silhouette Raw Steel: Grp2</p>	 <p>A683 L 4 3/4" X H 3" Shown with Metal Silhouette Raw Steel: Grp2</p>
 <p>A684 L 4 1/4" X H 2 1/2" Raw Steel: Grp2</p>	 <p>A685 Large L 5 1/4" X H 5" Raw Steel: Grp2</p>	 <p>A686 L 4 1/2" X H 3 3/4" Oiled Bronze: Grp2</p>	 <p>A687 L 4 3/4" X H 3 1/4" Oiled Bronze: Grp2</p>

urban slim brackets

Brackets available in Standard 3" and 6" Projection as well as Custom Projections for Urban Slim Rods only.

 <p>955-3</p>	 <p>955-D Double Bracket 3" and 6" Projection</p>	 <p>956-3 3D</p>	 <p>956-D 3D Double Bracket 3" and 6" Projection</p>	 <p>957-3</p>	 <p>957-D Double Bracket 3" and 6" Projection</p>
 <p>955-TS Top Support</p>	 <p>955-H Horizontal Bracket</p>	 <p>956-TS 3D Top Support</p>	 <p>956-H 3D Horizontal Bracket</p>	 <p>957-TS Top Support</p>	 <p>957-H Horizontal Bracket</p>

*Urban Slim Bracket Styles 956 and 957 with Invisible Screws shown in Dark Steel: Grp 2.

bypass system

 <p>1050-3</p>	 <p>Bypass System Black: Grp1</p>	 <p>505 Round Bypass Ring Black Grp: 1</p>	 <p>1050-U3 Invisible Screws</p>
 <p>1050-D Double Bracket 3" and 6" Projection</p>	 <p>1050-U3 3D Invisible Screws</p>	 <p>1050-UTS 3D Top Support Invisible Screws</p>	 <p>1050-UTS Top Support Invisible Screws</p>
 <p>1050-H Horizontal Bracket</p>	 <p>1050-UH 3D Horizontal Bracket Invisible Screws</p>	 <p>1050-UH Horizontal Bracket Invisible Screws</p>	

*All Bypass Brackets shown in Copper Vecchio: Grp 2.

Plated Collection

- Rod Styles and Sizes..... 27
- Monaco Finial Collection..... 28
- Glass Plated Finial Collection..... 29
- Contempo Plated Finial Collection..... 30
- Manhattan Plated Finial Collection..... 31
- Metropolis Plated Finial Collection..... 32
- Urban Plated Finials..... 33
- Contempo Plated Tiebacks..... 33

Plated Accessories

- Corner Bracket, Elbows, etc..... 34
- Hand Crafted brackets..... 35

Signature Brackets

- Manhattan Plated brackets..... 36
- Urban Plated brackets Invisible screws..... 36
- Regal Plated brackets Invisible screws..... 37

Urban and French Rods with Returns

- Regal, Urban & Traditional Mounting plates..... 38
- Urban Slim Collection..... 39
- Urban Slim Acrylic Rods & Finials..... 40
- Urban Slim Brackets and Bypass System..... 41



plated rod styles

Rod styles available in our 13 plated finishes

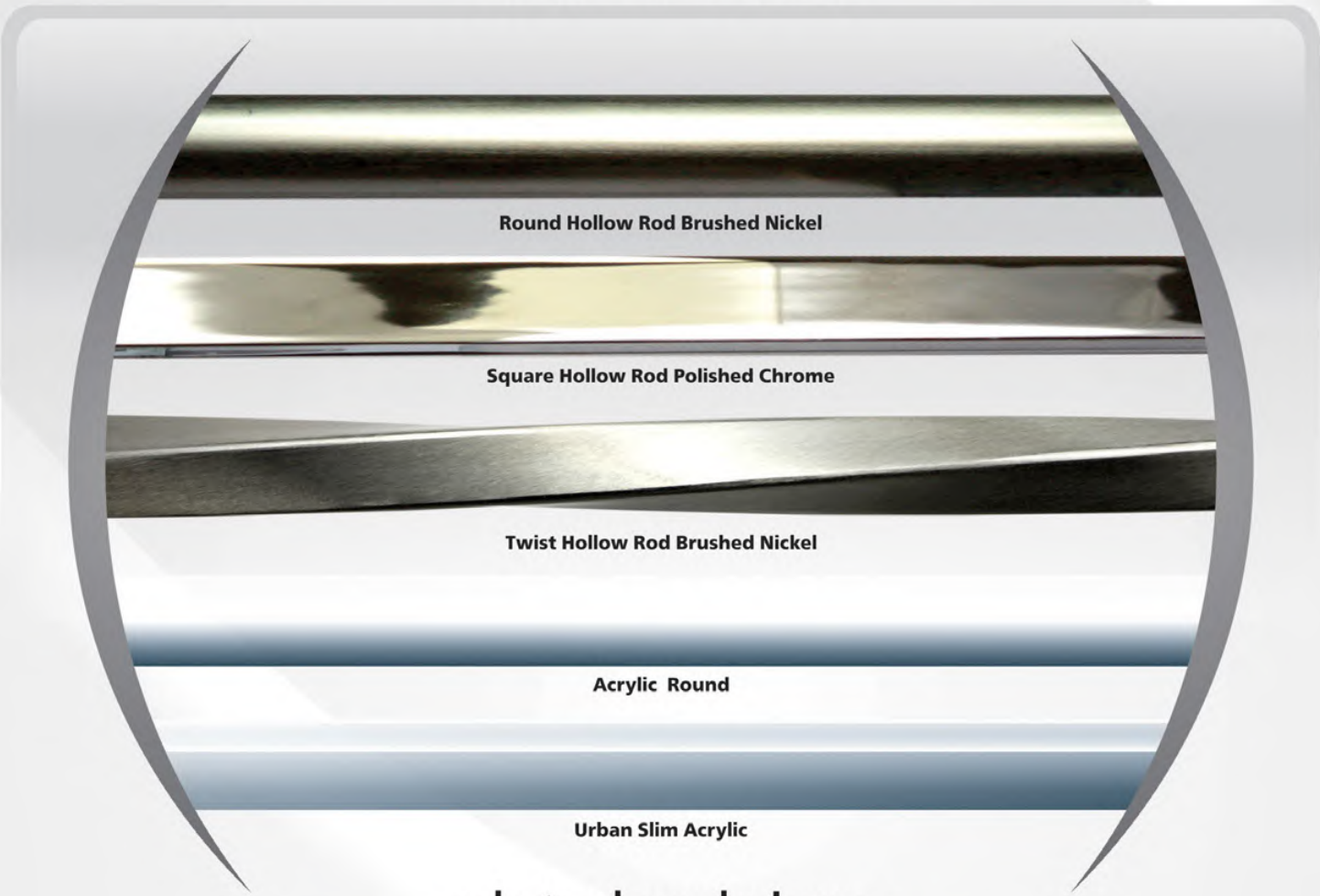

plated rod sizes



Round Rods

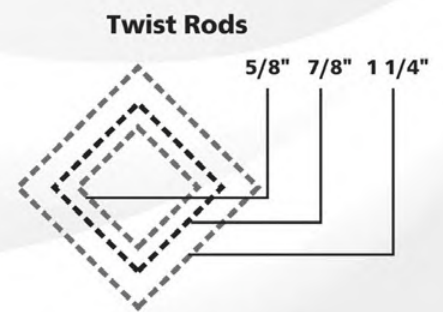

Twist Rods

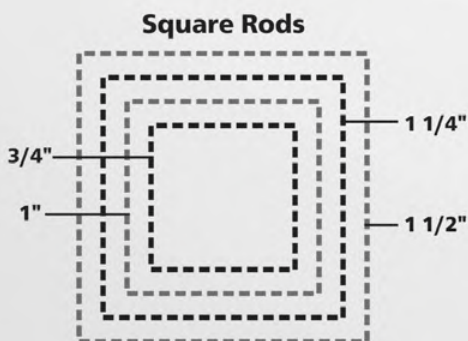

Square Rods

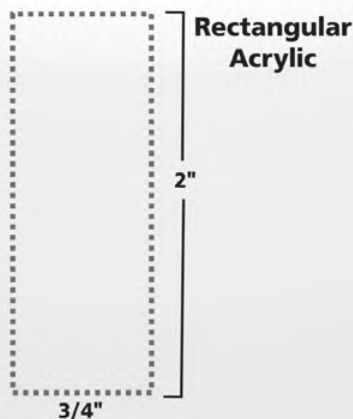

Rectangular Acrylic

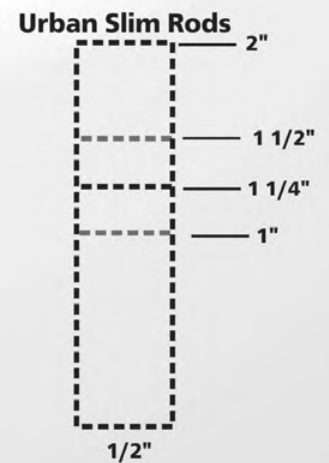

Urban Slim Rods



plated finials

Rods, Tiebacks, Accessories, Batons, Rings and Brackets can also be combined to design a stunning look

monaco finial collection

Create your own Design by combining up to 2 Tones from our 13 plated finishes.



M-3260
L 4" x H 1 3/4"
Brushed Onyx &
Polished Nickel



M-3261
L 3 1/4" x H 1 3/4"
Brushed Brass &
Polished Nickel



M-3262
L 2 1/4" x H 1 3/4"
Brushed Steel &
Polished Chrome



M-3263
L 3" x H 2"
Brushed Brass &
Polished Nickel



M-3264
L 3" x H 2"
Polished Nickel &
Brushed Onyx



M-3265
L 3" x H 2"
Polished Chrome &
Brushed Onyx



M-3266
L 3" x H 2"
Polished Chrome &
Polished Brass



M-3267
L 3" x H 2"
Brushed Onyx &
Polished Brass



M-3268
L 3 1/4" x H 1 1/2"
Brushed Nickel &
Polished Chrome



M-3269
L 3 1/4" x H 2 1/4"
Brushed Onyx &
Polished Brass



M-3270
L 3" x H 2"
Polished Chrome &
Brushed Onyx

M-4330
L 3 1/2" x H 1 3/4"
Brushed Brass &
Polished Nickel

M-4334
L 3" x H 2"
Polished Nickel &
Polished Brass

M-4341
L 3" x H 2"
Polished Nickel &
Polished Brass

M-4346
L 4" x H 3"
Brushed Steel &
Polished Brass

M-1509
L 3 5/8" x H 2 1/2"
Polished Nickel &
Brushed Onyx

M-1510
L 3 1/2" x H 2 1/2"
Brushed Onyx &
Polished Nickel

M-1517
L 3 1/2" x H 2 1/2"
Polished Brass &
Polished Nickel



plated finials



glass plated finial collection



1501
L 3 1/4" x H 1 7/8"
Brushed Nickel: P1



NC-1501
L 2 1/4" x H 1 7/8"
Polished Nickel: P2



1502
L 3 1/2" x H 2 1/2"
Polished Chrome: P2



NC-1502
L 2 1/2" x H 2 1/2"
Polished Nickel: P2



1503
L 4 1/4" x H 1 1/2"
Brushed Onyx: P3



NC-1503
L 3 1/4" x H 1 1/2"
Polished Nickel: P2



1504
L 3 1/2" x H 2 1/2"
Brushed Brass: P3



NC-1504
L 2 1/2" x H 2 1/2"
Polished Nickel: P2



1505 Small
L 3 3/4" x H 2"
Polished Brass: P4



1505 Large
L 4 1/4" x H 2 3/4"
Brushed Nickel: P1



NC-1506 Small
L 2 1/2" x H 2 1/2"
Polished Nickel: P2



1506 Large
L 3 3/4" x H 2 3/4"
Brushed Nickel: P1



1512
L 3" x H 2 3/4"
Polished Chrome: P2



NC-1512
L 2" x H 2 3/4"
Polished Nickel: P2



1513
L 2 1/2" x H 2 1/4"
Brushed Nickel: P1



NC-1513
L 1 1/2" x H 2 1/4"
Polished Chrome: P2



1516
L 3" x H 1 3/4"
Polished Chrome: P2



NC-1516
L 2" x H 1 3/4"
Polished Nickel: P2



4343
L 5/8" x H 2"
Polished Chrome: P2



4345
L 5/8" x H 2"
Polished Chrome: P2

contempo plated finial collection

1530
L 3 1/4" X H 1 1/2"
Brushed Onyx: P3

1531
L 3" X H 2"
Polished Chrome: P2

1532
L 2 3/4" X H 1 3/4"
Brushed Nickel: P1

1533
L 1 3/4" X H 2 1/4"
Brushed Nickel: P1

1534
L 2 3/4" X H 1 1/2"
Brushed Brass: P3

1535
L 2 1/4" X H 1 1/2"
Polished Brass: P4

1536
L 2 3/8" x H 1 1/2"
Polished Brass: P4

1537
L 2 1/4" x H 1 1/2"
Polished Nickel: P2

1538
L 2 1/4" x H 1 1/2"
Brushed Nickel: P1

1539
L 2 1/4" x H 2"
Polished Nickel: P2

1540
L 1/2" x H 2"
Brushed Brass: P3

1541
L 1/2" x H 2"
Polished Brass: P4

1542
L 1/2" x H 1 7/8"
Brushed Onyx: P3

1566-A Small
L 5/8" X H 1 3/4"
Polished Brass: P4

1566-A Large
L 5/8" X H 2"
Polished Chrome: P2

1566-B-Small
L 5/8" X H 1 3/4"
Brushed Onyx: P3

1566-B-Large
L 5/8" x H 2"
Brushed Onyx: P3

1566-C-Small
L 5/8" x H 1 3/4"
Brushed Nickel: P1

1566-C-Large
L 5/8" x H 2"
Polished Chrome: P2

1566-D-Small
L 5/8" x H 1 3/4"
Brushed Brass: P3

1566-D-Large
L 5/8" x H 2"
Brushed Nickel: P1

plated finials

F

All Finials can be utilized as Tiebacks.

manhattan plated finial collection

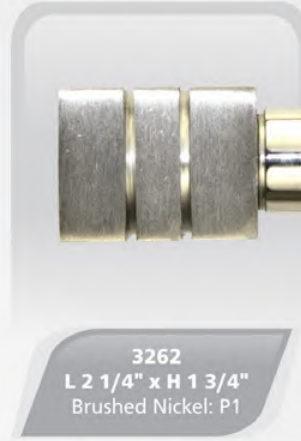
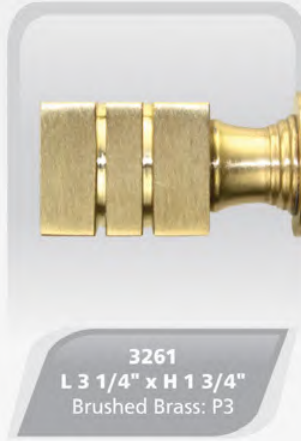

plated finials

All Finials can be utilized as Tiebacks.

metropolis plated finial collection



4330
L 1 3/4" x H 2 1/4"
Vintage Chrome: P5



4331
L 2 3/4" x H 2"
Brushed Onyx: P3



4332
L 3 1/2" x H 1 3/4"
Anti Brass: P4



4333
L 2 1/2" x H 1 3/4"
Nickel Bronze: P4



4334
L 3" x H 2"
Polished Nickel: P2



4335
L 2" x H 2"
Nickel Bronze: P4



4336
L 2 1/2" x H 2"
Vintage Brass: P5



4337
L 2 3/4" x H 2"
Vintage Steel: P5



4338
L 2 1/2" x H 2"
Polished Chrome: P2



4339
L 2 3/4" x H 2"
Vintage Rubbed
Bronze: P5



4341
L 3" x H 2"
Brushed Nickel: P1



4342
L 1/2" x H 2"
Brushed Steel: P1



4344
L 1/2" x H 2"
Brushed Steel: P1



4346
L 4" x H 3"
Brushed Steel: P1

plated finials & tiebacks

F

urban plated finials



Urban Slim Finials 4680 to 4687 are available for Urban Slim Rods 1" to 2" as well as Iron Round Rods from 1" to 2" Diameter.



contempo plated tiebacks

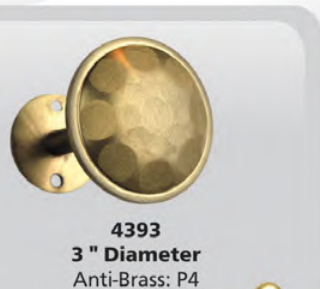

plated accessories



1560
Swivel Elbow
Interior Fit Only
Brushed Nickel: P1



1561
Swivel Corner Bracket
Interior Fit Only
Brushed Nickel: P1



1562
Elbow
Shown as 45° Exterior Fit
Polished Chrome: P2



1563
Corner Bracket
Shown as 90° Exterior Fit
Polished Chrome: P2



1564
Half Socket
Exterior Fit Only
Brushed Onyx: P3



1565
Full Socket
Exterior Fit Only
Brushed Nickel: P1



1566
End Cap
Interior Fit Only
Brushed Onyx: P3



1566 RE
Ring End Cap
Interior Fit Only
Brushed Nickel: P1



1566 FE
Flush End Cap
Exterior Fit Only
Brushed Brass: P3



1566 SQ
Square End Cap
Interior Fit Only
Brushed Brass: P3

contempo plated batons/wands



1620
L 3" X H 5/8"
Polished Nickel: P2



1621
L 3" X H 5/8"
Brushed Onyx: P3



1568
3/4" Ball
Polished Brass: P4



1569
Plain
Polished Brass: P4



AB
Acrylic Clear
Baton 1/2" Diameter

plated rings



1570
Smooth Round
Brushed Nickel: P1



1571
Rectangular
Polished Chrome: P2



1572
Bypass
Brushed Nickel: P1



1573
Flat Round
Polished Chrome: P2



1574
Flat Rectangular
Brushed Nickel: P1



1575
Urban Slim
Polished Chrome: P2

hand crafted plated brackets

1550 brackets

*All Brackets are available in standard 3" & 6" projection as well as custom projections for any rod style.



1550-SP
Short Projection
1" Clearance



1550-3
3" Projection



1550-6
6" Projection



1550-C
Ceiling Bracket



1550-H
Horizontal Backplate



1550-TS
Top Support



1550-D
Double Bracket
3" and 6" Projection

*All 1550 Brackets shown in Brushed Steel: P1.

slim 1550 brackets

*All Brackets are available in standard 3" & 6" projection as well as custom projections for any rod style.



S1550-SP
Short Projection
1" Clearance



S1550-3
3" Projection



S1550-6
6" Projection



S1550-C
Ceiling Bracket



S1550-H
Horizontal Backplate



S1550-TS
Top Support



S1550-D
Double Bracket
3" and 6" Projection

*All Slim 1550 Brackets are made out of 3/4" Wide Heavy Gauge material, shown in Brushed Brass: P3.

contempo brackets

*All Brackets are available in standard 3" & 6" projection as well as custom projections for any rod style.



1551-3
3" Projection



1552-3 3D
3" Projection
Invisible Screws



1551-RECT 3
3" Projection



1552-RECT 3 3D
3" Projection
Invisible Screws



1551-D
Double Bracket
3" and 6" Projection



1552-D
Double Bracket
3" and 6" Projection
Invisible Screws



1551-RECT D
Double Bracket
3" and 6" Projection



1552-RECT D
Double Bracket
3" and 6" Projection
Invisible Screws

*All Contempo Bracket shown in Brushed Onyx: P3.



signature plated brackets

manhattan brackets

Brackets are available in standard 3" & 6" projection as well as custom projections for any rod style.



4520-3
3" Projection



4520-D
Double Bracket
3" and 6" Projection



4521-3 3D
3" Projection



4521-D 3D
Double Bracket
3" and 6" Projection



4522-3
3" Projection



4522-D
Double Bracket
3" and 6" Projection



4520-TS
Top Support



4520-H
Horizontal Bracket



4521-TS 3D
Top Support



4521-H 3D
Horizontal Bracket



4522-TS
Top Support



4522-H
Horizontal Bracket

*Manhattan Brackets 4521 and 4522 Styles with Invisible Screws, all Brackets shown in Brushed Nickel P1.

urban brackets invisible screws

*All Brackets are available in standard 3" & 6" projection as well as custom projections for any rod style.



1550-U3
3" Projection

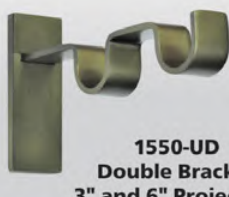

1550-UD
Double Bracket
3" and 6" Projection



1550-U3 3D
3" Projection

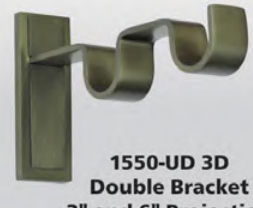

1550-UD 3D
Double Bracket
3" and 6" Projection



1550-UTS
Top Support



1550-UH
Horizontal Bracket



1550-UTS 3D
Top Support



1550-UH 3D
Horizontal Bracket

*All Urban Brackets shown in Anti-Brass: P4.

slim urban brackets invisible screws

*All Brackets are available in standard 3" & 6" projection as well as custom projections for any rod style.



S1550-U3
3" Projection

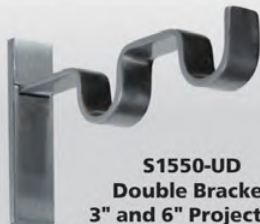

S1550-UD
Double Bracket
3" and 6" Projection



S1550-U3 3D
3" Projection



S1550-UD 3D
Double Bracket
3" and 6" Projection



S1550-UTS
Top Support



S1550-UH
Horizontal Bracket
Shown for Square Rod



S1550-UTS 3D
Top Support



S1550-UH 3D
Horizontal Bracket
Shown for Square Rod

*All Slim Urban Brackets are made out of 3/4" Wide Heavy Gauge material, shown in Brushed Steel: P1.

signature plated brackets



regal brackets

All Regal Brackets are available as Standard 3" Projection for Round Rods from 3/4" to 1 1/2" only, with Invisible screws.
All Regal Brackets are available in Custom Projections.

Mix and Match any Bracket Arm with any Mounting Plate to create your Personalized Bracket.



5531-TS
Shown with MP:B



5532-TS
Shown with MP:C



5533-TS
Shown with MP:A



5534-TS
Shown with MP:D



5535-TS
Shown with MP:A



5536-TS
Shown with MP:A

*All Regal Top Support Brackets shown in Polished Nickel: P2.



5531



5532



5533



5534



5535



5536

*All Regal Brackets shown with Mounting Plate "C" in Brushed Brass: P3. *MP: Mounting Plate.

regal 1550 brackets

*All Brackets are available in Standard 3" and 6" Projection as well as Custom Projections for any rod style with invisible screws.



R1550-A TS



R1550-B TS



R1550-C TS



R1550-D TS



R1550-A



R1550-B



R1550-C



R1550-D



R1550-A D
Double Bracket
3" and 6" Projection



R1550-B D
Double Bracket
3" and 6" Projection



R1550-C D
Double Bracket
3" and 6" Projection



R1550-D D
Double Bracket
3" and 6" Projection

*All Regal 1550 Brackets shown in Brushed Onyx: P3. *TS: Top Support

traditional brackets

*All Brackets are available in Standard 3" and 6" Projection as well as Custom Projections for any rod style.



15207-3
Brushed Steel: P1



15207-H
Horizontal Bracket
Brushed Steel: P1



15209-3
Brushed Steel: P1



15209-H
Horizontal Bracket
Brushed Steel: P1

urban and french plated rods with returns

regal mounting plates

All Regal Mounting Plates can be utilized with Urban and French Rods with Returns.



1590-RA
Shown with
Urban Return Rod



Urban Rod Style shown as
Single 1 1/4" Rod

Shown with
Mounting Plates
1590-RB & 1590-RA



1590-RB
Top Support Shown
with Urban Return Rod



1590-RC
Shown with
Urban Return Rod



1590-RD
Top Support
Shown with
Urban Return Rod



1590-RE
Shown with
French Return Rod



1590-RF
Top Support
Shown with
French Return Rod



1590-RG
Shown with
French Return Rod



1590-RH
Top Support
Shown with
French Return Rod

*All Regal Mounting Plates shown in Polished Nickel: P2.

urban mounting plates

All Urban Mounting Plates can be utilized with Urban and French Rods with Returns.



1590-A
Shown with
Urban Return Rod



Urban Rod Style shown as Double 1" Rod
3" and 6" Projection
Polished Brass: P4

Shown with
Mounting Plates 1590-D



1590-B 3D
Shown with
Urban Return Rod



1590-C
Shown with
French Return Rod



1590-D
Top Support
Shown with
French Return Rod



1590-E
Shown with Urban
Square Return Rod



1590-F
Top Support
Shown with
Urban Square
Return Rod



1590-G 3D
Shown with
Urban Return Rod



1590-H 3D
Top Support
Shown with
Urban Return Rod

*All Urban Mounting Plates shown in Vintage Brass: P5.

traditional mounting plates

All Traditional Mounting Plates can be utilized with Urban and French Rods with Returns.



1590
Mounting Plate
Brushed Onyx: P3



French Rod Style shown as Double 1" Rod
Brushed Brass: P3

Shown with
Mounting Plates 1590



1590-SQ
Shown with French
Square Rod
Brushed Steel: P1



1590-207
Shown with
French Rod
Brushed Steel: P1



1590-209
Shown with
French Rod
Brushed Steel: P1

urban slim plated collection

R

urban slim return rods

Urban Slim Return Rods are available in 1", 1 1/4", 1 1/2" and 2".



1952-C
Shown in 1 1/4" Rod



1952-2" Urban Slim Return Rod
Shown with Mounting Plates
1952-G
Polished Brass: P4



1575
Urban Slim
Polished Chrome: P2



1952-D
Top Support
Shown in 1 1/4" Rod



1952-E 3D
Shown in 1 1/2" Rod



1952-F 3D
Top Support
Shown in 1 1/2" Rod



1952-G
Shown in 2" Rod



1952-H
Top Support
Shown in 2" Rod

*Urban Slim Mounting Plate Styles 1952-E to 1952-H with Invisible Screws shown in Polished Brass: P5.

urban slim rods

Urban Slim Rods are available on 1", 1 1/4", 1 1/2" and 2".



1951-2" Urban Slim Rod
Shown with Finials 4644 & 4645
Brushed Nickel: P1



Custom 2" Round Rod
Shown with Urban Slim Finials 4684 & 4685-L
Brushed Steel: P1

urban slim finials

Urban Slim Finials 4640 to 4647 are only available for #1951-2" Urban Slim Rods.



4640
L 4 1/4" X H 2"
Polished Brass: P4



4641
L 4 1/4" X H 2"
Polished Brass: P4



4642
L 3 3/4" X H 2"
Brushed Brass: P3



4643
L 4 1/4" X H 2"
Brushed Brass: P3



4644
L 3 3/4" X H 2"
Brushed Nickel: P1



4645
L 4 1/4" X H 2"
Brushed Nickel: P1



4646
L 3 3/4" X H 2"
Brushed Onyx: P3



4647
L 3 3/4" X H 2"
Brushed Onyx: P3



urban slim plated collection

urban slim finials

Urban Slim Finials 4680 to 4687 are available for Urban Slim Rods 1" to 2" as well as Iron Round Rods from 1" to 2".

4680
L 5 1/4" X H 3"
Polished Chrome: P2

4681
L 5 3/4" X H 2 3/4"
Polished Chrome: P2

4682
L 4 1/2" X H 2 3/4"
Vintage Steel: P5

4683
L 4 3/4" X H 3 1/4"
Vintage Steel: P5

4684
L 4 1/2" X H 2 1/2"
Brushed Steel: P1

4685-Large
L 5 1/4" X H 5"
Brushed Steel: P1

4686
L 4 1/2" X H 3 3/4"
Polished Nickel: P2

4687
L 4 3/4" X H 3 1/4"
Polished Nickel: P2

acrylic rods



960-2" Urban Slim Acrylic Rod
Shown with Finials A4640 & A4647
Polished Nickel: P2



961-1 1/2" Round Acrylic Rod with
Acrylic Finials A4684 & A4685-L with Metal Silhouette
Brushed Brass: P3

urban slim acrylic finials

Urban Slim Acrylic Finials A4640 to A4647 are available with Optional Metal Silhouette for #960- 2" Urban Slim Acrylic Rod only.

A4640
L 4" X H 2"
Polished Nickel: P2

A4641
L 4" X H 2"
Polished Nickel: P2

A4642
L 3 1/2" X H 2"
Polished Nickel: P2

A4643
L 4" X H 2"
Polished Nickel: P2

A4644
L 3 1/2" X H 2"
Polished Nickel: P2

A4645
L 4" X H 2"
Polished Nickel: P2

A4646
L 3 1/2" X H 2"
Polished Nickel: P2

A4647
L 3 1/2" X H 2"
Polished Nickel: P2

urban slim plated collection















urban acrylic finials

Urban Slim Acrylic Finials A4680 to A4687 are available with Optional Metal Silhouette for Urban Acrylic rods and Round Iron Rods 1 1/4" to 2".

 <p>A4680 L 5 1/2" X H 3" Shown with Metal silhouette Polished Chrome: P2</p>	 <p>A4681 L 6" X H 2 3/4" Shown with Metal Silhouette Polished Chrome: P2</p>	 <p>A4682 L 4 1/4" X H 2 3/4" Brushed Brass: P3</p>	 <p>A4683 L 4 3/4" X H 3" Brushed Brass: P3</p>
 <p>A4684 L 4 1/4" X H 2 1/2" Brushed Brass: P3</p>	 <p>A4685 Large L 5 1/4" X H 5" Shown with Metal Silhouette Brushed Brass: P3</p>	 <p>A4686 L 4 1/2" X H 3 3/4" Polished Nickel: P2</p>	 <p>A4687 L 4 3/4" X H 3 1/4" Polished Nickel: P2</p>

urban slim brackets

Brackets available in Standard 3" and 6" Projection as well as Custom Projections for Urban Slim Rods only.

 <p>1955-3</p>	 <p>1955-D Double Bracket 3" and 6" Projection</p>	 <p>1956-3 3D</p>	 <p>1956-D 3D Double Bracket 3" and 6" Projection</p>	 <p>1957-3</p>	 <p>1957-D Double Bracket 3" and 6" Projection</p>
 <p>1955-TS Top Support</p>	 <p>1955-H Horizontal Bracket</p>	 <p>1956-TS 3D Top Support</p>	 <p>1956-H 3D Horizontal Bracket</p>	 <p>1957-TS Top Support</p>	 <p>1957-H Horizontal Bracket</p>

*Urban Slim Bracket styles 1956 and 1957 with Invisible Screws shown in Vintage Chrome: P5.

bypass plated system

 <p>1554-3</p>	 <p>Bypass Plated System Shown in 1" Round Rod Brushed Nickel: P1</p>	 <p>1572 Bypass Ring Brushed Nickel P1</p>	 <p>1554-U3</p>
 <p>1554-D Double Bracket 3" and 6" Projection</p>	 <p>1554-U3 3D</p>	 <p>1554-UTS 3D Top Support</p>	 <p>1554-UTS Top Support</p>
 <p>1554-H Horizontal Bracket</p>	 <p>1554-UH 3D Horizontal Bracket</p>	 <p>1554-UH Horizontal Bracket</p>	 <p>1554-UH Horizontal Bracket</p>

*All Bypass Brackets shown in Brushed Steel:P1. *Bypass Urban Brackets with Invisible Screws.

Traversing Rods

- Somfy Motorized Traverse System..... 43
- Somfy Accessories 44
- Demi-Round Traverse System..... 45
- Demi-Square Traverse System..... 46
- Demi-Wood Traverse System..... 47
- Demi-Bellus Traverse System..... 48
- Demi-Brackets & Accessories..... 49
- Euro Traverse System..... 50
- Rod Valance System..... 50



motorized traverse systems

somfy motorized traverse system

Available as single and double systems as pinch pleat and ripplefold.



3005-R
Somfy Demi-Round 1 1/2"
Brushed Brass: P3



3008-S
Somfy Demi-Square 2"
Shown with Returns & Rings # 2121
Gunmetal Blue: Grp3



3021-WF
Somfy Demi-Wood Fluted 2"
Dark Walnut Stain



3024-V
Somfy Demi-Vogue 2 1/2"
Oiled Bronze: Grp2



3030-UA
Somfy Demi-Urban Acrylic 2"
Polished Chrome: P2



35004-B
Somfy Demi-Bellus
Polished Chrome: P2

motorized traverse systems

somfy accessories

telis hand-held remote controls / radio technology somfy® (RTS)



Telis 1 Pure 1810632 **Telis 4 Pure** 1816033 **Telis 1 Silver** 1810639 **Telis 4 Silver** 1810641 **Telis 1 Black** 1810650 **Telis 4 Black** 1810652 **Telis 16 White** 1811081 **Telis 16 Silver** 1811082

smooove wall switches

Smooove Wall Switches includes Wall Switch and Frame.



Amber Bamboo 9015026 **Walnut** 9015237 **Cherry** 9015236 **Silver** 9015025 **Black** 9015023 **Light Bamboo** 9015027 **Pure** 1811533 **Double Pure** 1811533D

decoflex wirefree™ wall switches / radio technology somfy® (RTS)



DecoFlex White 1 Channel **DecoFlex White 2 Channels** **DecoFlex Ivory 3 Channels** **DecoFlex Ivory 4 Channels** **DecoFlex Black 5 Channels**

*DecoFlex Wall Switches are available in White, Ivory & Black, please refer to Price List for full item list.

myLink™

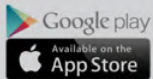

MyLink (Only) 1811403

decoflex wirefree™ RTS table top accessories



Table Top Black 1811051 **Table Top Silver** 1810972 **Table Top White** 1811185

16 channel interface



1810872

motors



Glydea® 60e RTS 1001617 **Glydea® Ultra 60 RTS** 1003159 **Irismo 45™ WireFree RTS** 1002353 **Battery** 9019741

somfy track finishes

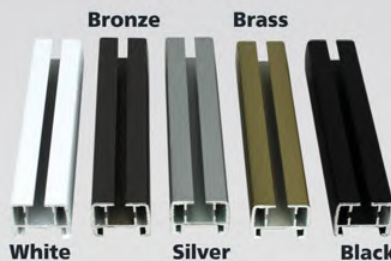

White **Silver** **Black** **Bronze** **Brass**

somfy glide



Bronze **White**

ripplefold glide



Bronze **White**

traverse rod collection *inspired*

Available as single and double systems as pinch pleat and ripplefold.



demi-round

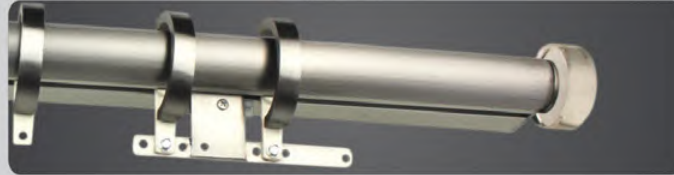
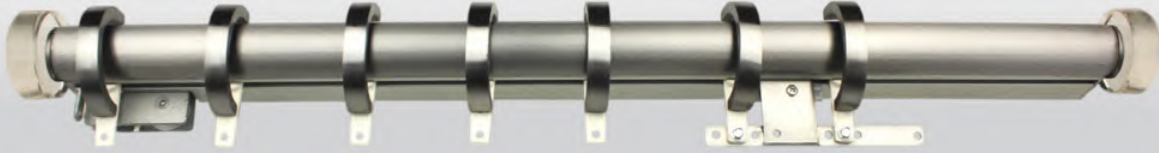

2100-R
Demi-Round Rod 1 1/4"
Shown with Rings #2117
Brushed Nickel: P1



2102-RD
Demi-Round
Double 2" & 1"
Vintage Steel: P5



2101-R
Demi-Round 1 1/2"
Shown with Returns
Gunmetal Blue: Grp 3

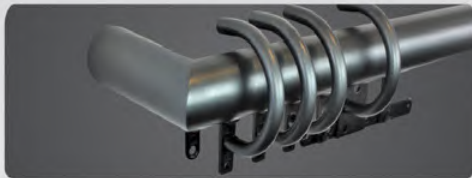

2125-Miter Returns
with Flush Mounting Plate
(Round Demi-Rods only)



2125-Miter Returns
with 926-RE Mounting Plate

demi-round rings

All demi-rings with ball bearing glides.

2115
Smooth Round
Olive: Grp3



2116
Hammered Round
Oxide: Grp2



2117
Flat Round
Brushed Nickel: P1



traverse rod collection

Available as single and double systems as pinch pleat and ripplefold.

demi-square



2103-S
Demi-Square Rod 1 1/4"
Shown with Rings # 2121
Polished Nickel: P2

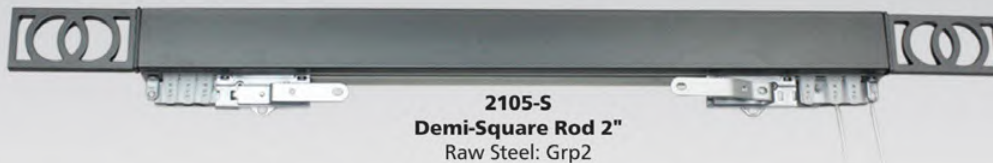

2105-S
Demi-Square Rod 2"
Raw Steel: Grp2

demi-square rings

All demi-rings with ball bearing glides.

2119
Smooth Square
Mystique: Grp2



2120
Hammered Square
Black Nickel: Grp2



2121
Flat Square
Brushed Onyx: P3



demi-round & demi-square return rod regal mounting plates

Available for Somfy & Demi-Traverse Rods.



D1590-RA
Top Support
Polished Nickel: P2



D926-RB
Top Support
Gunmetal Blue: Grp3



D1590-RC
Top Support
Polished Nickel: P2



D926-RD
Top Support
Gunmetal Blue: Grp3



D1590-RE
Top Support
Polished Nickel: P2



D926-RF
Top Support
Gunmetal Blue: Grp3



D1590-RG
Top Support
Polished Nickel: P2



D926-RH
Top Support
Gunmetal Blue: Grp3

demi-round & demi-square return rod urban mounting plates



D1590-C
Top Support
Polished Brass: P4



D926-E
Top Support
Oiled Bronze: Grp2



D926-G 3D
Top Support
Gunmetal Blue: Grp3



D1590-D
Top Support
Polished Brass: P4



D926-F
Top Support
Oiled Bronze: Grp2



D926-H 3D
Top Support
Gunmetal Blue: Grp3

traverse rod collection *inspired*



demi-wood

Available as single and double systems as pinch pleated and ripplefold.



2200-WS
Demi-Wood 2" Smooth
Dark Walnut Stain



2201-WF
Demi-Wood 2" Fluted
Shown with Rings #2230
Noir: Grp3



2200-WS
Demi-Wood 2" Smooth With #2125 Miter Returns
White: Grp2

demi-wood rings

All rings with ball bearing glides.



2230 Smooth
Oiled Bronze: Grp2



2232 Fluted
Custom Finish Grp: 4

demi-vogue

Available in Wood 2 1/2" Height



2223-V Demi-Vogue Dark Walnut with Accent #1
Accent finish Polished Brass: P4



2224-V Demi-Vogue
Oiled Bronze: Grp2



2223-V Demi-Vogue Mahogany with Accent #2
Accent finish Brushed Steel: P1



2225-V Demi-Vogue
Black Nickel: Grp2



2223-V Demi-Vogue White Grp 2 with Accent #3
Accent finish Brushed Brass: P3



2226-V Demi-Vogue
Dark Walnut Stain

demi-urban acrylic

Available in 2" Demi-Urban Acrylic



2430-UA 2" Demi-Urban Acrylic
Shown with Finials A4686 & A4687
Brushed Brass: P3



2430-UA 2" Demi-Urban Acrylic
Shown with Finials A4643 & A4645
with Metal Silhouette
Satin Silver: Grp2

traverse rod collection *traverse rods*

demi-bellus

Available as single and double systems as pinch pleat and ripplefold.



DB-5000 H-4"
(Shown with 3 1/2" Returns)
Renaissance: Grp3



DB-5003 H-3 1/2"
(Shown with Returns)
White: Grp2



DB-5001 H-3 1/2"
(Shown with Finial 05 Large)
Plume: Grp3



DB-5004 H-3 1/2"
(Shown with Finials 1727)
Enigma: Grp2



DB-5002 H-2 1/2"
(Shown with 3 1/2" Returns)
Cava: Grp2



DB-5005 H-2 1/2"
(Shown with Finial 133-3")
Oiled Bronze: Grp2

demi-bellus plated



DB-5000 H-4"
(Shown as Double Traverse System with 7" Returns)
Brushed Nickel: P1



DB-5003 H-3 1/2"
(Shown with finials 1506-Large)
Brushed Brass: P3



DB-5001 H-3 1/2"
(Shown with 3 1/2" Returns)
Polished Chrome: P2



DB-5004 H-3 1/2"
(Shown with 3 1/2" Returns)
Polished Nickel: P2



DB-5002 H-2 1/2"
(Shown with Finials 4330)
Polished Brass: P4



DB-5005 H-2 1/2"
(Shown with 3 1/2" Returns)
Brushed Onyx: P3

*H=Height

traverse rod collection



demi-brackets

Universal demi-brackets for all demi-motorized and demi-traverse systems.



2110
Single Bracket



2110-D
Double Bracket



2110-C
Ceiling Bracket



2110-H
Horizontal Bracket



2110-D F
Double Bracket
Ring and Glide
Eyelet Level



2111-U
Single Bracket



2111-UD
Double Bracket



2111-UH
Horizontal Bracket



2112-UTS 3D
Single Bracket
Top Support



2112-UD 3D
Double Bracket



2112-UH 3D
Horizontal Bracket



Somfy
Demi-Bracket
Clip



Demi-Bracket
Clip

*All Universal demi-brackets shown in Brown: Grp 1. *Demi-brackets 2111 & 2112 are made with Invisible Screws.

demi-rod connector covers



2126 Demi-Round
Connector Cover



2126 Demi-Square
Connector Cover



2126 Demi-Wood
Connector Cover



2126 Demi-Vogue
Connector Cover



2126 Demi-Urban Acrylic
Connector Cover



2126 Demi-Bellus
Connector Cover

demi tracks and glides

demi-track finishes

White

Silver

Black

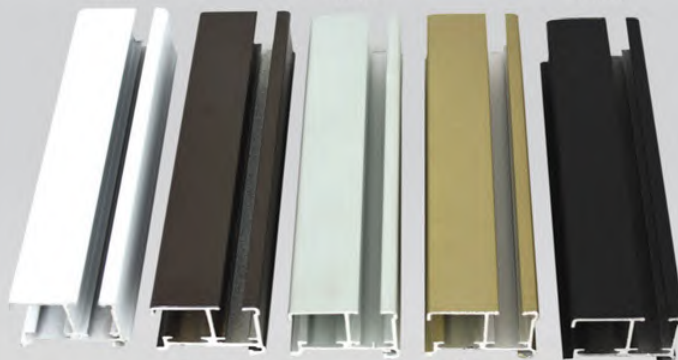

Bronze

Brass

ball bearing glide colors



Bronze



White



Black

ripplefold glide colors

demi-ring glide colors



Bronze



White



Black



White



Bronze

euro-traverse rod collection

euro-traverse

Euro-traverse Full Rod (not corded) Systems are available in Round and Square 1 1/4", 1 1/2" and 2".



2151 Euro-Round 1 1/2"
Shown with Finials NC-1506 Small with Rings # 2115
Brushed Onyx: P3



2154 Euro-Square 1 1/4"
Shown with Finials 62
Black Nickel: Grp2

euro brackets

Brackets are available in Standard 3" Projection for Single Rod and 3" & 6" for Double Rods.



2160-3
Merlot: Grp2



2160-TS
Top Support
Merlot: Grp2



2161-3 3D
Shown for Square Rod
Vintage Steel: P5



2161-TS 3D
Top Support
Shown for Square Rod
Vintage Steel: P5



2162-3
Merlot: Grp2



2162-TS
Top Support
Merlot: Grp2



2160-D
Double Bracket
Merlot: Grp2



2161-D 3D
Double Bracket
Shown for Square Rod
Vintage Steel: P5



2162-D
Double Bracket
Merlot: Grp2

*Euro-Brackets 2161 & 2162 are made with Invisible Screws.

euro rings

All rings with ball bearing glides.

round rings



2115
Smooth Round



2117
Flat Round

square rings



2119
Smooth Square



2121
Flat Square

glide colors



Bronze White Black

ring glide colors



Bronze White Black

ripplefold glide



White Bronze

rod-valance



◀ Single
Double ▶



1435
Single Bracket
6" Projection
Gold Vecchio: Grp2



Single Rod Valance
Shown On 1 1/4" Round Bent Rod
Gold Vecchio: Grp 2



1435
Double Bracket
7 1/2" Projection
Old Bronze: Grp2

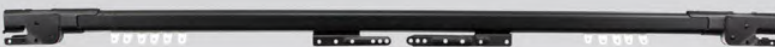

1428
Heavy Duty Track
Old Bronze: Grp2

1429
Heavy Duty
Traverse Track
Single Bracket
Oiled Bronze: Grp2



wood collection

Collection available for 1 3/8" & 2" Wood Poles as well as for Metal Rods.

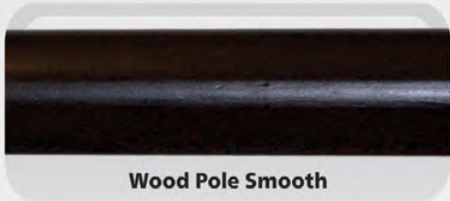

Wood Pole Smooth

wood poles



Wood Pole Fluted

wood finials



1800
Light Walnut: Stain



1801
Dark Walnut: Stain



1802
White: Grp 2



1803
Gold Vecchio: Grp2



1804
Old Bronze: Grp2

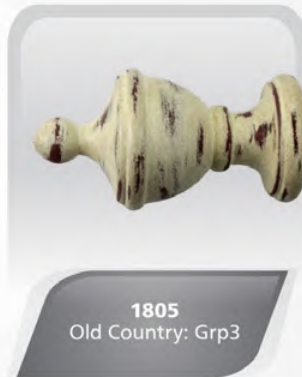

1805
Old Country: Grp3



1806
Burnt Sienna: Grp3

wood tieback



1810
U-shaped
Shown with
Finial 1803
Dark Walnut:
Stain

wood accessories



1830
Half Socket
Custom Color: Grp 4

1831
Full Socket
Rusted Black: Grp3

1832
End Cap
Custom Color: Grp 4

1833
Swivel Elbow
Dark Walnut: Stain

wood brackets



1820
4" Projection
Mahogany: Stain



1821
4" Projection
Verdy Vecchio: Grp3



1821
7" Projection
Enigma: Grp2

wood rings



1840 Fluted
Gold Vecchio: Grp2



1841 Smooth
Burnt Sienna: Grp 3

Baton 1835
Custom Color:
Grp 4



resin collection

Collection available for 2" Wood Poles as well as for Metal Rods.

resin finials



1720
L 4 1/2" x H 3 3/4"
Oiled Bronze: Grp2



1721
L 5" x H 4"
Dark Umber: Grp2



1722
L 5 1/4" x H 3 3/4"
Heirloom: Grp2



1723
L 6" x H 3 1/4"
Merlot: Grp2



1724
L 4 3/4" x H 3"
Black Nickel: Grp2



1725
L 5" x H 3 1/2"
Cava: Grp2



1726
L 7" x H 3 1/2"
Mystique: Grp2



1727
L 6" x H 3 1/2"
Radiant Gold: Grp2



1728
L 5 1/2" x H 3 3/4"
Plume: Grp3



1729
L 6" x H 3 3/4"
Old Bronze: Grp2



1730
L 4 3/4" x H 4"
Old Country: Grp3



1731
L 6" x H 3 3/4"
Verdy Vecchio:
Grp3



1732
L 4 3/4" x H 3 1/4"
Burnt Sienna:
Grp3

resin brackets



1750
For 2" Wood Poles
H 5 1/2" L 6" x P 4"
Verdy Vecchio: Grp3



1750 D
For 1 3/8" and 2"
Wood Poles
H 5 1/2" L 9 1/2" x P 3" and 7"
Verdy Vecchio: Grp3



1751
For 2" Wood Poles
H 5 1/2" L 6" x P 4"
Renaissance: Grp3



1751 D
For 1 3/8" and 2"
Wood Poles
H 5 1/2" L 9 1/2" x P 3" and 7"
Renaissance: Grp3

resin tiebacks



1760
5" Diameter
Renaissance: Grp3



1761
5" Diameter
Old Country: Grp3



1762
5" Diameter
Vintage: Grp3



1763
4 1/2" Square
Plume: Grp3



1764
4 1/2" Square
Burnt Sienna: Grp3

resin end caps



1780
3 1/2" Diameter
Old Country: Grp3



1781
3 1/2" Diameter
Old Bronze: Grp2



1782
3" Diameter
Plume: Grp3

resin rings



1790
3/4" Thickness
2 3/4" ID Only
Old Bronze: Grp2



1791
3/4" Thickness
2 3/4" ID Only
Plume: Grp3



1792
3/4" Thickness
2 3/4" ID Only
Renaissance: Grp3



cornices & crowns

cornices



2000
Panel L 27 1/4" X H 10 3/4"
Enigma: Grp2



2010
Cornice Return
Enigma: Grp 2



2001
Panel L 27 1/2" X H 10 1/2"
Dark Umber: Grp2



2002
Panel L 27" X H 10 1/2"
Oxide: Grp2



2003
Panel L 29" X H 7 3/4"
Custom Color: Grp4

crowns



1300
L 26 1/2" X H 15"
Renaissance: Grp3



1302
L 37" X H 13"
Old Country: Grp3



1301
L 23" X H 7 1/2"
Old Bronze: Grp2

1303
L 40" X H 15 1/2"
Enigma: Grp2



1304
L 38" X H 20"
Vintage: Grp3



1305
L 33 1/2" X H 9"
Tarnished Brown:
Grp3



1306
L 36" X H 9"
Verdy Vecchio:
Grp3



decorative rods

artisan rods

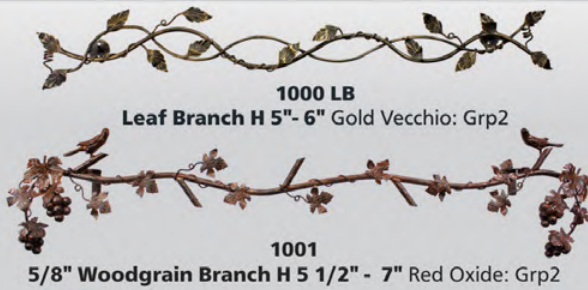

scrolls



swing arms



swift program



105
L 3 1/4" x H 3"
Old Bronze: Grp2



106
L 5 1/4" x H 4"
Gold Vecchio: Grp2



1501
L 3 1/4" x H 1 7/8"
Brushed Nickel: P1



1502
3 1/2" x H 2 1/2"
Brushed Nickel: P1



114
L 2" x H 2 1/4"
Old Bronze: Grp2



115
L 3 1/2" x H 2 1/2"
Copper Vecchio: Grp2



1503
L 4 1/2" x H 1 1/2"
Brushed Nickel: P1



1506 Small
3 1/2" x H 2 1/2"
Brushed Nickel: P1



116
L 7 1/2" x H 4"
Oxide: Grp2



118
L 4" x H 2 1/4"
Old Bronze: Grp2



1506 Large
L 3 3/4" x H 2 3/4"
Brushed Nickel: P1



1510
L 3 1/2" x H 2 1/2"
Brushed Nickel: P1



134-2"
Smooth
2" Diameter
Gold Vecchio: Grp2



135
3" Diameter
Gold Vecchio: Grp2



1514
L 3 1/4" x H 2 1/4"
Brushed Nickel: P1



1517
L 3 1/2" x H 2 1/2"
Brushed Nickel: P1



Bracket 304-3
3" Projection
Black: Grp1



Bracket 304-D
3" and 6" Projection
Black: Grp1



Ring 500
Round Smooth
Black: Grp1



Bracket 1550-3
3" Projection
Brushed Nickel: P1



Bracket 1550-D
3" and 6" Projection
Brushed Nickel: P1



Ring 1570 Round Smooth
Brushed Nickel: P1

Next Day Finishes

3-Day Delivery Finishes

3-Day Delivery Plated Finishes



Black
Grp 1



Gold Vecchio
Grp 2



Old Bronze
Grp 2



Copper Vecchio
Grp 2



Oxide
Grp 2



Red Oxide
Grp 2



Brushed Nickel
P1

designer's tools *by Xentric*

S

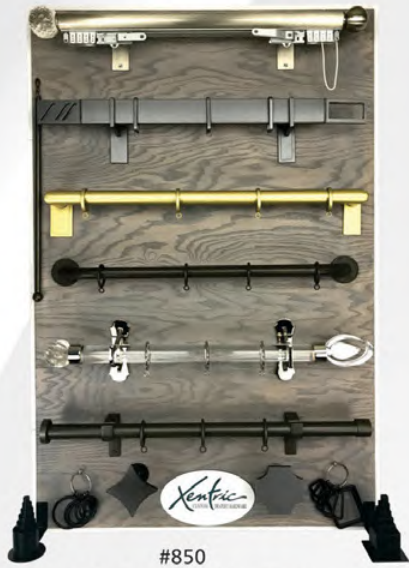

#850
platinum display



#851
gold display



#852
designer presentation case



#859
round rod set



#860
square rod set



#861
round ring set



#862
square ring set



#853
designer platinum package



#854
designer gold package

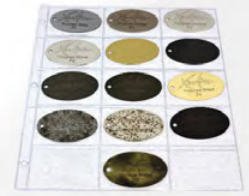

#857
plated finish selector



#855
designer silver package



#856
hand painted/stains
finish selector



#858
individual finish sample

measurement guide

finial

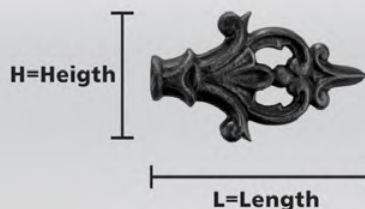

bracket



ring

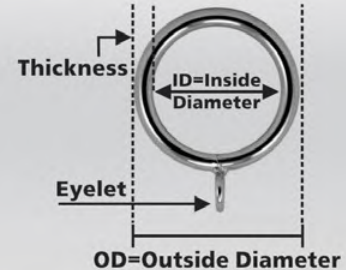

finishes

All colors are hand-made and variations may occur, please refer to Xentric's Finish selector before ordering.

group 1



Black



Brown



Light Brown

group 2



Black Nickel



Cava



Copper Vecchio



Dark Steel



Dark Umber



Dusty Gold



Enigma



Gold Vecchio



Heirloom



Merlot



Mystique



Oiled Bronze



Old Bronze



Oxide



Radiant Gold

finishes

All colors are hand-made and variations may occur, please refer to Xentric's Finish selector before ordering.



group 2



Red Oxide



Raw Steel



Satin Bronze



Satin Silver



White

group 3



Burned Brass



Burnt Sienna



Flare



Gunmetal Blue



Noir



Old Country



Olive



Plume



Renaissance



Rusted Black



Rustic

finishes

All colors are hand-made and variations may occur, please refer to Xentric's Finish selector before ordering.

group 3



Tarnished Brown



Verdy Vecchio



Vintage

plated finishes

Plated 1

Plated 2



Brushed Steel



Brushed Nickel



Polished Chrome



Polished Nickel

Plated 3



Brushed Brass



Brushed Onyx

Plated 4



Nickel Bronze



Anti-Brass



Polished Brass

Plated 5



Vintage Steel



Vintage Chrome



Vintage Rubbed Bronze



Vintage Brass

finishes

stains



Dark Walnut



Light Walnut



Mahogany

Custom Color Matching Available

Custom Gold & Silver Leaf Finishes Available



Ring used as Reference for color Matching

*custom paneling services available in:
Stainless Steel, Iron, Acrylic & Wood.*



Shown as Room Dividers

Call us for a quote...

Shown as Custom Displays



Xentric
CUSTOM DRAPERY HARDWARE

Established 2005

www.myxentric.com

1 (866) 4-Xentric
1 8 6 6 4 9 3 6 8 7 4 2