



TRADITIONAL
BEAMS

Enhancing Natural Beauty

Standard 12mm concealed brackets fitting instructions

Supplied with oak fireplace beams 11 cm (4.25") deep or more as well as our floating shelves. Manufactured to high standards by Hafele. Please be aware that these brackets can only be fitted to masonry walls or stud walls where timber can be located. They are not suitable for fitting solely to plasterboard. These simple brackets can support up to 35kg of weight between two (including the weight of the shelf).

You will need...



Silicone OR
Grab
Adhesive



Silicone
Applicator
Gun



Tape
Measure



Pencil



Hammer



Drill



10mm
Drill Bit



10mm
Spanner



Spirit
Level

STEP 1

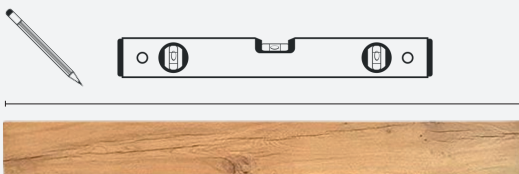

Using a spirit level, draw a line on your wall the same width as your beam or shelf.

STEP 2

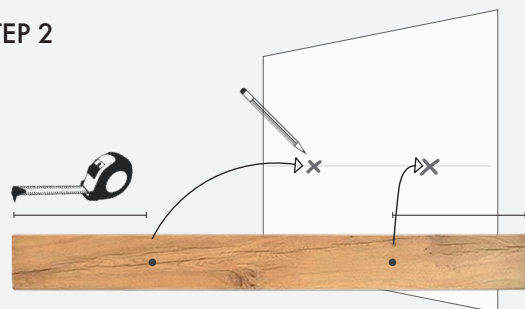

Measure from the end of the beam/shelf to the hole centres and transfer these measurements onto your wall.

STEP 3

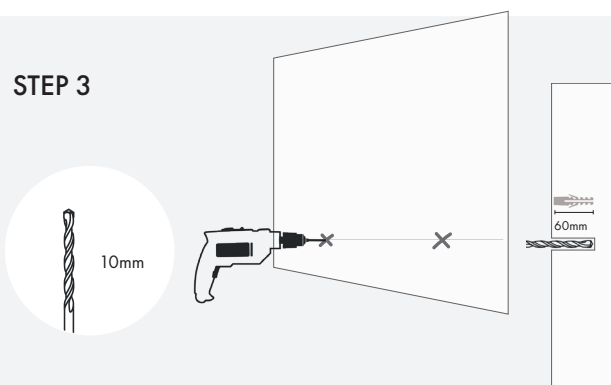

Using a 10mm masonry drill bit for solid walls or 10mm wood bit for stud walls, drill a hole at least 60mm deep to fully accommodate the wall plug.

STEP 4

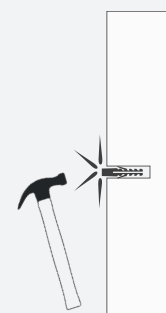

Insert the wall plugs into the holes. Use a hammer to tap the wall plugs flush with your wall.

STEP 5

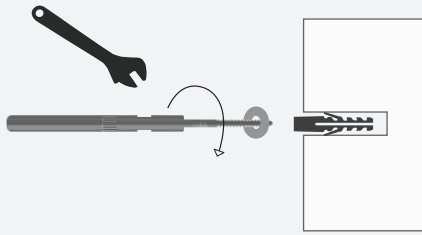

Using a 10mm spanner, screw the brackets into the wall.
The washer vastly increases the load capacity and is recommended.

STEP 6

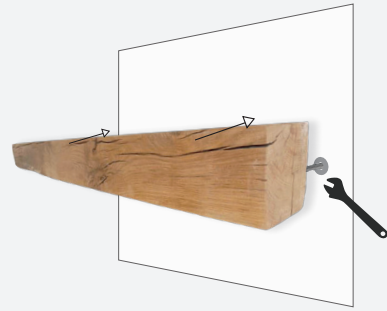

Slide the beam/shelf $\frac{3}{4}$ of the way onto the brackets so that you can still fit a spanner behind to make any adjustments.

STEP 7

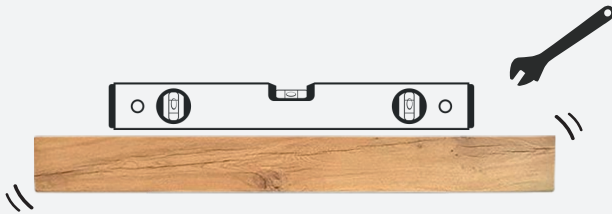

The screw part of the bracket is positioned slightly off centre to the main body of the bracket allowing you to make minor adjustments for levelling. Place a spirit level on the beam/ shelf and use a 10mm spanner to make any minor adjustments to level the beam.

STEP 8

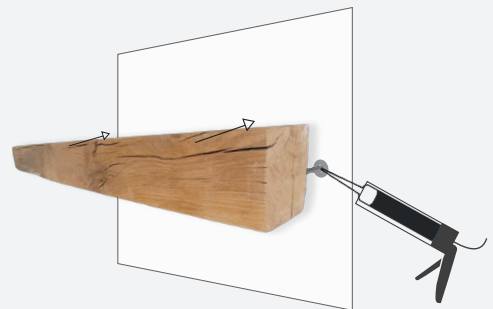

For additional precaution a small amount of silicone or grab adhesive can be applied in the fixing holes to prevent the beam/shelf from becoming loose. Slide the beam/ shelf flush to your wall. As the holes are only 1mm wider than the brackets you'll find it's a tight fit.

Now sit back and enjoy!

