

---

MULTI-FUNCTION ELECTRIC  
TWIN PRESSURE  
RICE COOKER

---

OPERATING INSTRUCTIONS

---

CRP-ST10 TOOL  
1.8L(1~10Persons)

---

# CUCKOO



**CUCKOOELECTRONICS CO.,LTD.**

# CONTENTS

## CONTENTS

### BEFORE USING

IMPORTANT SAFEGUARDS .....	3
SPECIFICATIONS .....	5
SAFETY PRECAUTIONS .....	6~7
PART IDENTIFICATION .....	14
HOW TO CLEAN .....	15~19
HOW TO OPERATE .....	20
ERROR CODES .....	20

### WHEN USING

HIGH PRESSURE MODE & NON PRESSURE MODE .....	21
HOW TO SET OR CANCEL VOICE GUIDE FUNCTION .....	22
BEFORE COOKING RICE .....	23
HOW TO COOK .....	24~25
HOW TO USE "CUSTOMIZED COOKING FUNCTION" .....	26
HOW TO USE "GABA RICE (BROWN RICE)" .....	27~28
HOW TO COOK HIGH PRESSURE STEAM .....	29
HOW TO OPEN COOK .....	30
HOW TO COOK NON PRESSURE STEAM .....	31
HOW TO COOK PORRIDGE .....	32
HOW TO COOK FROZEN STORED RICE .....	33
HOW TO USE PRESET FUNCTION .....	34~35
KEEP WARM .....	36~37

### BEFORE ASKING FOR SERVICE

TROUBLESHOOTING .....	38~40
-----------------------	-------

### COOKING GUIDE

COOKING GUIDE .....	41~54
---------------------	-------

## TABLE DES MATIÈRES

### MANUEL D'UTILISATION FRANÇAIS

MESURES DE PROTECTION IMPORTANTES .....	4
SPÉCIFICATIONS .....	5
MESURES DE SÉCURITÉ .....	12~13

## 목차

### 한국어 사용설명서

IMPORTANT SAFEGUARDS .....	3
제품규격 .....	5
안전상의 경고 .....	8~9
각 부분의 이름 .....	55
기능 조작부의 이름과 역할 .....	56
기능 표시부의 이상점검 기능 .....	56
고압모드 또는 무압모드 선택 방법 .....	57
취사는 이렇게 하십시오 .....	58
취사/자동세척은 이렇게 하십시오 .....	59
오픈 쿠킹은 이렇게 하십시오 .....	60
예약 취사는 이렇게 하십시오 .....	61~62

## 目录

### 中文使用说明书

IMPORTANT SAFEGUARDS .....	3
规格 .....	5
安全警告 .....	10~11
产品部件名称 .....	63
功能操作部名称及作用 .....	64
功能显示部异常检测功能 .....	64
高压模式或无压模式选择方法 .....	65
煮饭方法 .....	66
煮饭/自动洗涤方法 .....	67
中途加料请这样操作 .....	68
预约煮饭的方法 .....	69~70

## IMPORTANT SAFEGUARDS

1. Read all instructions before using this appliance.
2. Do not touch hot surfaces. Use handles or knobs.
3. To protect against fire, electric shock and / or injury to persons do not immerse cord, plugs, or Pressure Cooker Body in water or any other liquid.
4. Close supervision is necessary when this appliance is used by or near children. This appliance is not intended for use by young children without supervision.
5. Unplug cord from outlet when not in use and before cleaning.  
Allow appliance to cool before putting on or taking off parts, and before cleaning the appliance.
6. Do not operate any appliance with a damaged cord or plug, after the appliance malfunctions, or has been damaged in any manner. Return the appliance to the nearest authorized service facility for examination, repair or adjustment.
7. The use of accessory attachments not recommended by the appliance manufacturer may result in fire, electric shock, and / or injury to persons.
8. If the supply cord is damaged, it must be replaced by a special cord or assembly available from the manufacturer or your service agent.
9. Do not use outdoors.
10. Do not let the cord hang over the edge of a table or counter, or touch hot surfaces.
11. Do not place on or near a hot gas, electric burner, or in a heated oven.
12. Always attach the plug to the appliance first, then plug the cord into the wall outlet. To disconnect, or set all control to "off", then remove the plug from the wall outlet.
13. Do not use this appliance for other than its intended use.
14. Extreme caution must be used when moving an appliance containing hot oil or any hot liquids.
15. Oversized foods, metal foil packages, or utensils must not be inserted into the appliance as they are a risk of fire or electric shock.
16. Fire may occur if the appliance is covered or touching flammable material, including curtains, draperies, walls, etc while in operation.
17. To reduce the risk of electric shock, cook only in the provided removable container.
18. This appliance cooks under pressure. Improper use may result in scalding injury.  
Before operating the unit, properly secure and close the unit. See "Operating Instructions."
19. Do not cook foods such as applesauce, cranberries, cereals, macaroni, spaghetti, or other foods.  
These foods tend to foam, froth, and sputter, and may block the pressure releasing device
20. Before use always check the pressure releasing device for clogging.
21. Do not open the pressure cooker until the unit has cooled and internal pressure has been reduced.  
See "Operating Instructions."
22. Do not use this pressure cooker to fry in oil.

## SAVE THESE INSTRUCTIONS THIS APPLIANCE IS FOR HOUSEHOLD USE ONLY

### ADDITIONAL IMPORTANT SAFEGUARDS

**WARNING :** This appliance generates heat and releases steam during use. Use proper precaution to prevent risk of burns, fires, other injuries, or damage to property.

1. Keep hands and face away from the Pressure Release Valve when releasing pressure.
2. Take extreme caution when opening the Lid after cooking. Severe burns can result from steam inside.
3. Never open the Lid while the unit is in operation.
4. Do not use without the inner Pot in place.
5. Do not cover the Pressure Valve with anything as an explosion may occur.
6. Do not touch the inner pot nor any heating parts, immediately after use.  
Allow the unit to cool down completely first.

This appliance is intended to be used in household and similar applications such as :

- staff kitchen areas in shops, offices and other working environments;
- farm houses;
- by clients in hotels, motels and other residential type environments;
- bed and breakfast type environments.

## MESURES DE PROTECTION IMPORTANTES

1. Lisez toutes les instructions avant d'utiliser cet appareil.
2. Ne touchez pas les surfaces chaudes. Utilisez les poignées ou les boutons.
3. Pour prévenir les risques d'incendie, les chocs électriques et/ou les blessures, ne plongez pas le cordon, les prises ou le corps autocuiseur dans l'eau ou tout autre liquide.
4. Une surveillance étroite est nécessaire quand cet appareil est utilisé par des enfants ou qu'il se situe à leur portée. Cet appareil n'est pas prévu pour être utilisé par de jeunes enfants sans surveillance.
5. Débranchez le cordon de la prise lorsque vous ne vous servez pas de l'appareil et avant de le nettoyer. Laissez l'appareil refroidir avant de remettre en place ou de retirer des pièces, et avant de le nettoyer.
6. N'utilisez aucun appareil si le cordon ou la fiche est endommagé, s'il ne fonctionne pas correctement ou s'il est endommagé de quelque façon que ce soit. Renvoyez l'appareil à un centre technique agréé le plus proche pour le faire examiner, réparer ou régler.
7. L'utilisation d'accessoires non recommandés par le fabricant peut causer un incendie, un choc électrique et/ou des blessures.
8. Si le cordon d'alimentation est endommagé, il doit être remplacé par un cordon ou ensemble prévu à cet effet, disponible auprès du fabricant ou de réparateurs agréés.
9. N'utilisez pas l'appareil à l'extérieur.
10. Ne laissez pas le cordon pendre d'une table ou d'un comptoir. Ne le laissez pas non plus en contact avec une surface chaude.
11. Ne placez pas l'appareil au-dessus ou près d'un brûleur à gaz, sur une plaque électrique ou dans un four chaud.
12. Branchez toujours la fiche sur l'appareil en premier, puis branchez le cordon dans la prise murale. Pour débrancher, ou désactiver toutes les commandes, retirez la fiche de la prise murale.
13. N'utilisez pas cet appareil à des fins autres que celles pour lesquelles il a été conçu.
14. Une prudence extrême est requise lorsque vous déplacez l'appareil contenant de l'huile chaude ou tout autre liquide chaud.
15. Des denrées alimentaires de taille excessive, les emballages sous feuille métallique, ou les ustensiles ne doivent pas être insérés dans l'appareil car ils constituent un risque d'incendie ou de choc électrique.
16. Un incendie peut se déclarer si l'appareil est couvert ou en contact avec des matériaux inflammables, y compris des rideaux ou des draperies, des murs, etc durant son fonctionnement.
17. Afin de réduire le risque de choc électrique, faites cuire uniquement dans le récipient amovible fourni.
18. Cet appareil cuit sous pression. Un mauvais usage peut entraîner des brûlures. Avant d'utiliser l'appareil, mettez l'appareil bien en place et fermez-le. Reportez-vous à la section « Instructions d'utilisation ».
19. Ne cuisinez pas des aliments tels que compotes de pommes, canneberges, céréales, macaronis, spaghettis ou autres. Ces aliments ont tendance à mousser, écumer et à crépiter et peuvent obstruer le dispositif de relâchement de la pression.
20. Avant toute utilisation, vérifiez toujours si le dispositif de relâchement de la pression est obstrué.
21. N'ouvrez pas l'autocuiseur jusqu'à ce que l'appareil ait refroidi et que la pression interne ait diminué. Reportez-vous à la section « Instructions d'utilisation ».
22. N'utilisez pas cet autocuiseur pour faire frire dans de l'huile.

## CONSERVEZ CES INSTRUCTIONS

CET APPAREIL EST DESTINÉ À UN USAGE DOMESTIQUE UNIQUEMENT

## MESURES DE PROTECTION SUPPLÉMENTAIRES

**AVERTISSEMENT :** Cet appareil génère de la chaleur et libère de la vapeur durant son fonctionnement. Utilisez les protections appropriées pour prévenir le risque de brûlures, d'incendies, de blessures ou de dégâts matériels.

1. Gardez vos mains et votre visage à l'écart de la soupape de décharge lors du relâchement de la pression.
2. Faites extrêmement attention lors de l'ouverture du couvercle après la cuisson. La vapeur à l'intérieur peut provoquer des brûlures graves.
3. N'ouvrez jamais le couvercle lorsque l'appareil est en fonctionnement.
4. N'utilisez pas l'appareil sans la cuve de cuisson à sa place.
5. Ne recouvrez pas la soupape de pression par un objet quelconque, une explosion pourrait survenir.
6. Ne touchez pas la cuve de cuisson ni les éléments chauffants immédiatement après utilisation. Laissez tout d'abord l'appareil refroidir complètement. Cet appareil est prévu pour être utilisé à la maison à des fins telles que :
  - la cuisine pour le personnel dans des magasins, des bureaux et d'autres environnements de travail;
  - les fermes;
  - par des clients dans des hôtels, des motels et autres environnements de type résidentiel;
  - des environnements de type chambres d'hôtes.

# HOW TO USE EXTENSION CORD / COMMENT UTILISER UNE RALLONGE

## Note:

- A.** A short power-supply cord (or detachable power-supply cord) is provided to reduce the risk resulting from becoming entangled in or tripping over a longer cord.
- B.** Longer detachable power-supply cords or extension cords are available and may be used if care is exercised in their use.
- C.** If a longer detachable power-supply cord or extension cord is used:
- (1) The marked electrical rating of the cord set or extension cord should be at least as great as the electrical rating of the appliance;
  - (2) The cord should be arranged so that it will not drape over the countertop or tabletop where it can be pulled on by children or tripped over unintentionally; and
  - (3) If the appliance is of the grounded type, the cord set or extension cord should be a grounding-type 3-wire cord

This appliance has a polarized plug : (one blade is wider than the other).

As a safety feature, this plug will fit in a polarized outlet only one way.

If the plug does not properly fit in the outlet, turn the plug over.

If it still does not fit, contact a qualified electrician. Do not attempt to modify the plug in any way

Please, keep this safety feature.

## Remarque:

- A.** Un cordon d'alimentation court (ou détachable) vous est fourni pour réduire le risque de blessure personnelle en vous empiétant ou en trébuchant dans un cordon plus long.
- B.** Des rallonges ou cordons détachables sont disponibles et peuvent être utilisés si manipulé avec précaution.
- C.** En cas d'utilisation d'un cordon détachable ou d'une rallonge:
- (1) La puissance électrique indiquée sur la rallonge doit être au moins aussi élevée que la puissance de l'appareil
  - (2) La rallonge doit être disposée de manière à ne pas reposer sur le comptoir ou sur la table lorsqu'elle peut être tirée par un enfant.
  - (3) Si l'appareil est un modèle avec prise de terre, la rallonge doit être à trois conducteurs avec neutre.

Cet appareil est muni d'une prise polarisée (une lame est plus large que l'autre).

Par mesure de sécurité, ce cordon ne se branche dans une prise polarisée que d'une seule manière.

Si l'embout de l'appareil n'entre pas correctement dans la prise, inversez sa position.

Si le branchement de l'appareil n'est toujours pas possible, veuillez contacter un électricien qualifié. Ne tentez en AUCUNE façon de modifier l'embout électrique (la fiche) de l'appareil.

Veuillez respecter cette mesure de sécurité.

# SPECIFICATIONS / 제품규격 / 规格 / SPÉCIFICATIONS

Model name/型号名称/모델명		<b>CRP-ST10 TOOL</b>
Power supply/电源/전원		AC120V, 60Hz
Power consumption/功耗/소비전력		1150W
Cooking capacity	White Rice	1~10cups (0.18~1.8L)
	High Heat White Rice	
	Super Turbo White Rice	
	Mixed Rice	1~4cups (0.18~0.72L)
	High Heat Mixed Rice	
	GABA Rice	1~8cups (0.18~1.44L)
	High Heat GABA Rice	
	Non Pressure White Rice, Veggie Rice	
	Frozen Stored Rice	1~6cups (0.18~1.08L)
	Thick Porridge / Thin Porridge	1~2cups (0.18 ~ 0.36L) / 0.5~1cups (0.09 ~ 0.18L)
Power cord length/电源线长度/전원코드길이		4.3ft (1.3m)
Pressure/压力/사용압력		78.4KPa(0.8kgf/cm <sup>2</sup> )
Weight/重量/중량		15.9lbs (7.2kg)
Dimension/尺寸/치수	Width/宽度/폭	11.4inch (290mm)
	Length/长度/길이	15.3inch (389mm)
	Height/高度/높이	11.1inch (283mm)







# HOW SERVICE IS HANDLED / MISE EN OEUVRE DU SERVICE

**USA** The East and the Central Districts  
Tel. No. 718 888 9144  
The West and the Central Districts  
Tel. No. 323 780 8808

**Canada** TORONTO  
Tel. No. 905 707 8224  
VANCOUVER  
Tel. No. 604 540 1004

# SAFETY PRECAUTIONS

- Read the following product safety guide carefully to prevent any accidents and/or serious danger.
- 'Warning' and 'Caution' are different as follows.

 <b>Warning</b> This means that the action it describes may result in death or severe injury.	 • This sign is intended to remind and alert that something may cause problems under the certain situation.  • Please read and follow the instruction to avoid any harmful situation.
 <b>Caution</b> This means that the action it describes may result in injury or property damage.	 • Indicates a prohibition  • Indicates an instruction

## **Warning**      **Do not**

<p><b>Do not cover the automatic steam outlet or pressure weight with your hand or face.</b></p> <ul style="list-style-type: none"> <li>• It can cause burns.</li> <li>• Especially be careful to keep it out of children's reach.</li> </ul>	<p><b>Do not press the clamp knob button or turn the lock/unlock handle to "NON PRESSURE" while cooking.</b></p> <ul style="list-style-type: none"> <li>• If the appliance is opened by force, it can cause burns and an explosion.</li> <li>• Use the lock/unlock handle after the steam is completely exhausted.</li> </ul>
<p><b>Do not use the cooker near hot places such as stove, and avoid direct sunlight.</b></p> <ul style="list-style-type: none"> <li>• It can cause an electric shock, fire, deformation, malfunction, or discoloration. Please check the power cord and plug frequently.</li> </ul>	<p><b>Turn the Lock/Unlock handle to "HIGH PRESSURE" position and do not close the lid with the inner pot inside the machine.</b></p> <ul style="list-style-type: none"> <li>• Deformation or damage of the lock and inner pot can cause steam leakage or explosion.</li> </ul>
<p><b>Do not alter, reassemble, disassemble or repair.</b></p> <ul style="list-style-type: none"> <li>• It can cause fire, electric shock or injury.</li> <li>• For repair, contact dealer or the service center.</li> </ul>	<p><b>Do not insert metal objects such as pins and wires or any other external substances in the automatic steam exhaust outlet or any other slot.</b></p> <ul style="list-style-type: none"> <li>• It can cause an electric shock or fire.</li> <li>• Especially be careful to keep it out of reach of children.</li> </ul>
<p><b>Use a single socket with the rated current above 15A.</b></p> <ul style="list-style-type: none"> <li>• Using several lines in one socket can cause overheating or fire. Please check the power cord and plug frequently.</li> <li>• Use an extension cord with the rated current above 15A.</li> </ul>	<p><b>Keep the cooker out of reach of children.</b></p> <ul style="list-style-type: none"> <li>• It can cause burns, electric shock or injury.</li> </ul>
<p><b>Please pay careful attention against water and chemicals.</b></p> <ul style="list-style-type: none"> <li>• It can cause an electric shock or fire.</li> </ul>	<p><b>Don't spray or put any insecticides or chemicals.</b></p> <ul style="list-style-type: none"> <li>• It can cause an electric shock or fire.</li> <li>• If cockroaches or any insects get inside the cooker, please call a dealer or a service center.</li> </ul>
<p><b>Do not use a rice cooker at a place where dust is trapped or chemical material is located.</b></p> <ul style="list-style-type: none"> <li>• Do not use any combustible gas or flammable materials nearby a product.</li> <li>• It can cause explosion or fire.</li> </ul>	<p><b>Do not put any needle, cleaning pin etc in the ventilator or any gap of the cooker.</b></p> <ul style="list-style-type: none"> <li>• Do not insert cleaning pins to other parts except to the valve hole of the pressure weight.</li> <li>• It can cause an electric shock or fire.</li> </ul>
<p><b>Do not use damaged power cord, plug, or loose socket.</b></p> <ul style="list-style-type: none"> <li>• Please check the power cord frequently for damage.</li> <li>• Serious damage can cause electric shock or fire.</li> <li>• If the plug is damaged, contact the dealer or a service center.</li> </ul>	<p><b>Do not open the LID during heating and cooking.</b></p> <ul style="list-style-type: none"> <li>• It can cause burns.</li> <li>• If you need to open the lid while cooking, keep pressing the cancel button for 2 seconds and confirm internal steam is released, completely turning the pressure weight over.</li> </ul>
<p><b>Do not clean the product with water or any liquid types.</b></p> <ul style="list-style-type: none"> <li>• It can cause an electric shock or fire.</li> <li>• If it contacts water, please separate power cord and contact dealer and service center.</li> </ul>	<p><b>Do not bend, tie or pull the power cord.</b></p> <ul style="list-style-type: none"> <li>• It can cause an electric shock or short circuit resulting in fire. Please check the power cord and plug frequently.</li> </ul>
<p><b>Do not cover the automatic steam outlet or pressure weight with a duster, a towel, or apron, etc.</b></p> <ul style="list-style-type: none"> <li>• It can cause deformation or a breakdown.</li> <li>• It can cause an explosion by pressure.</li> </ul>	<p><b>Do not over unplug and plug the power cord excessively.</b></p> <ul style="list-style-type: none"> <li>• It can cause fire, electric shock or injury.</li> </ul>
<p><b>Do not use pots that are not designed for the cooker. Do not use other pots and do not use without inner pot.</b></p> <ul style="list-style-type: none"> <li>• It can cause an electric shock or fire.</li> </ul>	<p><b>Be careful that both the plug and power cord are not to be bit by animals, or pierced by sharp metal materials.</b></p> <ul style="list-style-type: none"> <li>• Damages by impact can cause an electric shock or fire. Please check the power cord and plug frequently.</li> </ul>
<p><b>Do not use the cooker without inner pot.</b></p> <ul style="list-style-type: none"> <li>• It can cause electric shock or malfunction.</li> <li>• Do not pour rice or water without the inner pot.</li> <li>• If rice or water gets inside the body then do not turn the product over or shake it please contact to dealer or service center.</li> </ul>	<p><b>Remove external substances on plug with a clean cloth.</b></p> <ul style="list-style-type: none"> <li>• It can cause fire. Please check the power cord and plug frequently.</li> </ul>

# SAFETY PRECAUTIONS

## Warning

**Do not use on a rice container or a shelf.**

- Do not place the power cord between furnitures. It can cause an electric shock resulting in fire.
- When the rice cooker is on the furniture, be cautious of steam release. It can damage the furniture, cause fire, and/or electric shock

**Do not place heavy things on the power cord.**

- It can cause an electric shock or fire.
- Please check the power cord and plug frequently

**Do not change, extend or connect the power cord without the advice of a technical expert.**

- It can cause an electric shock or fire.

**Clean any dust or external substances off the temperature sensor and inner pot.**

- It can cause a system malfunction or fire.

**Do not plug or pull the power cord with wet hands.**

- It can cause an electric shock.

**Do not move the product by pulling or using the power cord.**

- Electric short might cause fire.

## Caution

**Turn the lock/unlock handle to "HIGH PRESSURE" when the appliance is unplugged.**

- The internal pressure due to heated rice or Inner Pot can cause deformation or damage, if the lock/unlock handle is not in "Locked" position.
- Make sure to lock the lock/unlock handle during cooking and warming with high pressure.

**Wipe off any excessive water on the cooker after cooking.**

- It can cause odor and discoloration.
- Wipe off water that is left behind from dew.

**Please contact the dealer or service center when the unit is not working properly.**

**In case of a blackout during cooking, steam from a rice cooker will be released automatically. Thus, the quality of rice is lower than normal.**

- Please start cooking rice using the indicated amount of water.
- Water can overflow if the amount of water in a pot exceeds the indicated level of water usage.
- Please start cooking in a status that steam control cap is installed completely.

**When cooking food with bones, such as braised short ribs, please season the meat on a different plate.**

- The coating of the Inner Pot may wear away.
- If the coating of the inner pot gets scratched or wears away by customers' mistake, you have to pay for the repair even during the free repair service period.

**Please clean the body and other parts after cooking.**

- After cooking chicken soup or, multi cook dishes, etc., the smell may be absorbed.
- Clean the oven packing, top heater plate and inner pot every time you cook any of those.
- Use dry kitchen cleaner or sponge to clean the inner pot, since rough scrub or metallic ones are abrasive to the coating.
- Depending on the using methods or user's circumstances inner pot coating might rise. Please call the customer service for those cases.

**Be cautious when steam is being released.**

- When the steam is released don't be surprised.
- Please keep the cooker out of reach of children.

**If it is possible, use warming function for white rice ONLY.**

**When you pull out the power plug, don't pull the power cord by force. Please, safely pull out the power plug.**

- If you inflict impact on power cord, it can cause an electric shock or fire.

**Please rinse rice and place it in another plate and do not knock on the inner pot to brush off the remaining rice in the plate.**

- If the coating of the inner pot gets scratched or wears away by customers' mistake, you have to pay for the repair even during the free repair service period.

## Caution

## Do not

**Don't use the inner pot for various purposes.**

- It can cause deformation of the inner pot.
- The content of the inner pot might be spilled.

**Please call customer service if the inner pot coating peels off.**

- Inner pot coating may wear away after long use.
- When cleaning the inner pot, do not use tough scrubber, metallic scrubber, brush, abrasive metallic etc.

**Recommended type of scrubber to clean the inner pot (inside, outside)**

Available	Unavailable
Cotton scrubber, sponge, scrubber, extra-fine type, net scrubber	Blue green scrubber (abrasive type), steel stainless scrubber, other metallic scrubber

- If you use the unavailable scrubber, the coating of the inner pot may wear away.
- If the coating of the inner pot gets scratched or wears away by customers' mistake, you have to pay for the repair even during the free repair service period.

**Do not place on rough top or tilted top.**

- It can cause burns or breakdowns.
- Be careful to install the power cord to pass without disruption.

**Please contact a dealer or service center when there is a strange smell or smoke.**

- First pull out the power cord. And contact dealer or the service center

**Do not use over the maximum capacity.**

- It can cause product malfunction.
- Do not cook over capacity stated for cooking of chicken soup and congee.

**Do not use the cooker near magnetic field.**

- It can cause burns or breakdown.

**Do not drop the cooker.**

- It can cause a safety problem.

**After cooking, do not try to open the lid until the steam is fully released.**

- The hot steam or any hot content within the cooker can cause burns.
- Cautiously open the lid after cooking is done to avoid dangerous steam and burns.

**Do not put rice on a plate using metallic spoon or rice scoop instead of plastic or wooden rice scoop.**

- It can cause damage to the surface of the inner pot and the coating can wear away.
- If the coating of the inner pot gets scratched or wears away by customers' mistake, you have to pay for the repair even during the free repair service period.

**Do not touch the inner pot, inside of the cooker, heat plate and pressure weight during or after cooking or warming.**

- It can cause burns or scalding.
- If the pressure weight gets tilted, released steam can cause burns.

**Do not hold the cooker by the inner pot handle.**

- It can cause problems and danger. There are portable handles on the bottom right and left side of the cooker. Hold the handles with both hands and move it carefully.

**Use AC 120V only.**

- It can cause electric shock and fire.
- It can cause malfunctions.

**Use the product on flat surfaces. Do not use on a cushion. Please avoid using it on an unstable location prone to falling down.**

- It can cause malfunction or a fire. Please check the power cord and plug frequently.

**Do not exceed the designated amount while cooking.**

- If you exceed the amount of food that is designated in the recipe, it can cause overflow because of pressure weight and soft steam cap

**Please use the cooker for original purposes.**





- It can cause the malfunction or smell.



**Please pull out the plug when not in use.**

- It can cause electric shocks or fire.

# 안전상의 경고

- '안전상의 경고'는 제품을 안전하고 올바르게 사용하여 사고나 위험을 미리 막기 위한 것으로 반드시 지켜 주십시오.
- '안전상의 경고'는 '경고'와 '주의'의 두가지로 구분되어 있으며 '경고'와 '주의'의 의미는 다음과 같습니다.

 <b>경고</b>	피하지 않을 경우 사망이나 중상을 초래할 수 있는 잠재적인 위험상황		<ul style="list-style-type: none"> <li>• 이 기호는 특정조건하에서 위험을 끼칠 우려가 있는 상황에 초래할 수 있는 잠재적인 위험상황 대하여 주의의 환기시키는 표시입니다.</li> <li>• 위험 발생을 피하기 위해 주의권계 읽고 지시에 따라 사용하십시오.</li> </ul>
 <b>주의</b>	피하지 않을 경우 경상을 초래할 수 있는 잠재적인 위험상황		<ul style="list-style-type: none"> <li>• 이 기호는 어떤 행위를 '금지'하는 표시입니다.</li> <li>• 이 기호는 어떤 행위를 '지시'하는 표시입니다.</li> </ul>

 <b>경고</b>	 <b>(금지)</b>	
<p><b>사용중 압력추 및 자동증기 배출구에는 손과 얼굴을 가까이 하지 마십시오.</b></p> <ul style="list-style-type: none"> <li>• 화상의 우려가 있습니다. 취사중 나오는 증기는 매우 뜨거우므로 손이나 얼굴을 가까이 하지 마십시오.</li> <li>• 특히 어린이의 접근을 막아 주십시오.</li> </ul>	<p><b>내술 없이 사용을 하지 마십시오.</b></p> <ul style="list-style-type: none"> <li>• 감전 및 고장의 원인이 됩니다.</li> <li>• 내술이 없는 상태에서 썰이나 물을 넣지 마십시오.</li> <li>• 썰이나 물이 들어갔을 경우에는 제품을 뒤집거나 흔들지 마시고 고객 상담실로 꼭 문의 하십시오.</li> </ul>	
<p><b>제품을 직사광선이 쬐는 곳, 가스레인지, 라이터, 전열기구 풍로 등의 가까이에서 사용하지 마십시오.</b></p> <ul style="list-style-type: none"> <li>• 전기누전, 감전, 변형, 변색 및 화재의 원인이 됩니다.</li> <li>• 전원코드를 열기구 가까이 두지 마십시오. 코드피복이 녹아 화재, 감전의 원인이 됩니다. 수시로 전원코드의 상태를 꼭 확인하십시오.</li> </ul>	<p><b>취사나 요리가 진행 중일 때 뚜껑 열림 버튼을 누르거나, 뚜껑 결합 손잡이를 절대 "ㄴ 무압"으로 돌리지 마십시오.</b></p> <ul style="list-style-type: none"> <li>• 강제로 열 경우 압력으로 인해 화상 및 폭발의 위험이 있습니다.</li> <li>• 취사나 요리 완료 후 후기가 완전히 배출된 상태에서 뚜껑 결합 손잡이를 작동시키십시오.</li> </ul>	
<p><b>제품을 분해하거나 개조하지 마십시오.</b></p> <ul style="list-style-type: none"> <li>• 화재 및 감전의 원인이 됩니다.</li> <li>• 서비스기사이외의 사람이 분해하거나 수리하지 마십시오. 수리 및 고장 상담은 고객센터로 문의하여 주십시오.</li> </ul>	<p><b>뚜껑 결합 손잡이를 "고 고압" 위치에 놓고 내술을 넣고 뚜껑을 닫지 마십시오.</b></p> <ul style="list-style-type: none"> <li>• 점검장치 및 내술의 파손, 변형으로 증기누설이나 폭발의 위험이 있습니다.</li> </ul>	
<p><b>반드시 정격 15A 이상의 접지 단자가 있는 교류 120V 전용 콘센트에서만 사용해 주시고 한 콘센트에 여러 제품의 전원플러그를 동시에 꽂아 사용하지 마십시오.</b></p> <ul style="list-style-type: none"> <li>• 여러 제품과 함께 사용하거나, 다른 기구에 사용하면 발열 및 발화, 감전의 원인이 됩니다. 수시로 콘센트 상태를 꼭 확인하십시오.</li> <li>• 전원플러그에 이물질이나 물기가 묻어 있는 경우에는 잘닦은 다음 사용하십시오.</li> <li>• 연장코드도 15A이상의 것을 사용하여 주십시오.</li> </ul>	<p><b>내술 없이 분리형 커버, 핀팬, 금속성물질 등을 넣거나, 넣어서 사용하지 마십시오. (특히, 어린이 주의)</b></p> <ul style="list-style-type: none"> <li>• 감전 및 화재의 원인이 됩니다.</li> </ul>	
<p><b>싱크대, 목욕탕 등 제품에 물이 들어 갈 수 있는 곳이나, 눈을 맞을 수 있는 실외에서 사용하지 마십시오.</b></p> <ul style="list-style-type: none"> <li>• 전기 누전 및 감전의 위험이 있습니다.</li> <li>• 제품에 물이 들어 갔을 경우에는 고객센터로 꼭 문의 하십시오.</li> </ul>	<p><b>어린이 혼자 사용하지거나 어린이가 만질 수 있는 장소에 제품을 두지 마십시오.</b></p> <ul style="list-style-type: none"> <li>• 고열에 화상을 입거나 감전이 될 수 있습니다.</li> </ul>	
<p><b>먼지가 많은 곳이나 화학성 물질이 있는 곳에서는 사용하지 마십시오.</b></p> <ul style="list-style-type: none"> <li>• 제품 근처에서 가연성 가스나 인화성 물질 등을 사용하지 마십시오.</li> <li>• 폭발 및 화재의 원인이 됩니다.</li> </ul>	<p><b>제품내에 살충제나 화학물질 등을 뿌리거나 투입하지 마십시오.</b></p> <ul style="list-style-type: none"> <li>• 화재 발생의 우려가 있습니다.</li> <li>• 제품내 바퀴벌레나 벌레 등이 들어갔을 경우는 고객센터로 문의해 주십시오.</li> </ul>	
<p><b>전원코드나 전원플러그가 파손되었거나 콘센트가 흔들릴 때는 사용을 중지하고, 고객센터로 문의바랍니다.</b></p> <ul style="list-style-type: none"> <li>• 제품 사용 중 사용상의 부주의로 전원 코드의 피복이 벗겨지거나 찢힐 경우 화재 및 감전의 원인이 될 수 있으나, 수시로 전원코드와 전원플러그, 콘센트의 상태를 꼭 확인하십시오.</li> <li>• 전원코드나 전원플러그가 파손된 경우에는 위험이 생기지 않도록 하기 위하여 제조사나 판매점 또는 유자격 기술자/서비스 기사에 의해 고도 교환을 하십시오.</li> <li>• 반드시 지정된 서비스 센터에서 수리하시기 바랍니다.</li> </ul>	<p><b>흡·배기구 또는 토스 사이에 바늘, 청소용 핀, 금속물 등 이물질이 들어가거나 막히지 않도록 하십시오.</b></p> <ul style="list-style-type: none"> <li>• 감전 및 화재의 원인이 됩니다.</li> <li>• 청소용 핀을 증기배출구 청소구에 제품의 틈새나 구멍에 넣지 마십시오.</li> </ul>	
<p><b>제품을 싱크대에 넣고 닦거나 제품 내부에 물을 넣지 마십시오.</b></p> <ul style="list-style-type: none"> <li>• 전기 누전 및 감전, 화재의 원인이 됩니다.</li> <li>• 제품에 물이 들어간 경우에는 사용을 중지하고 전원플러그를 뽑은 다음 고객 상담실로 문의하여 주십시오.</li> </ul>	<p><b>취사나 요리가 진행 중일 때 절대로 뚜껑을 열지 마십시오.</b></p> <ul style="list-style-type: none"> <li>• 요리 중 끓어 넘치거나 증기가 누설되더라도 절대로 먼저 뚜껑을 열지 마십시오.</li> <li>• 강제로 뚜껑을 열면 내용을 비산으로 화상의 우려가 있습니다.</li> <li>• 취사 또는 요리가 진행 중일때 부득이하게 뚜껑을 열어야 할 경우 취사 버튼을 누른 후(내술 온도가 높으면 2초간) 내부 압력이 완전히 제거되었는지 확인을 하고 열어 주십시오.</li> <li>• 필로 시 제품의 사용을 중지하고 전원플러그를 뽑은 다음 고객센터로 문의 하여 주십시오.</li> </ul>	
<p><b>입력추 및 자동증기배출구를 막거나 증기구에 행주나 장식용 덮개, 기타 물건을 올린 채 사용하지 마십시오.</b></p> <ul style="list-style-type: none"> <li>• 압력에 의한 폭발의 위험이 있습니다.</li> <li>• 본체의 변형, 변색 및 고장의 원인이 됩니다.</li> </ul>	<p><b>전원코드를 무리하게 구부리거나, 묶거나, 잡아당기지 마십시오.</b></p> <ul style="list-style-type: none"> <li>• 감전이나 쇼크로 인해 화재의 원인이 될 수 있습니다. 수시로 전원코드 상태를 꼭 확인하십시오.</li> </ul>	
<p><b>변형된 내술이나 전용 내술이 아닌것은 사용하지 마십시오.</b></p> <ul style="list-style-type: none"> <li>• 내술이 가열되어 이상 작동 및 화재의 원인이 됩니다.</li> <li>• 내술을 떨어뜨렸거나 변형된 경우에는 고객센터로 문의해 주십시오.</li> </ul>	<p><b>전원플러그를 반복하여 뽑았다 꽂았다 하지 마십시오.</b></p> <ul style="list-style-type: none"> <li>• 감전 및 화재의 위험이 있습니다.</li> </ul>	
	<p><b>플러그 및 전원 코드부를 반력동물이 물어 뜯거나 못과 같이 날카로운 금속 물체로부터 충격을 받지 않도록 주의하여 주십시오.</b></p> <ul style="list-style-type: none"> <li>• 충격으로 인한 파손은 화재, 감전, 화재 등의 원인이 됩니다. 수시로 전원코드와 전원 플러그 상태를 꼭 확인하십시오.</li> </ul>	
	<p><b>전원플러그에 묻은 이물질은 물기가 없는 천으로 깨끗이 제거하여 주십시오.</b></p> <ul style="list-style-type: none"> <li>• 화재의 원인이 됩니다. 수시로 전원 플러그 상태를 꼭 확인하십시오.</li> </ul>	



## ⚠ 경고 (지시)

**쌀통 및 다용도 선반 등에 제품을 놓고 사용하지 않습니다.**

- 전원코드가 틈새에 걸리지 화재 및 감전의 원인이 됩니다. 수시로 전원코드 상태를 꼭 확인하십시오.
- 취사 또는 요리중 용기가 배출될 때 발동 및 다용도 선반에 의해 제품의 손상, 화재, 감전의 원인이 됩니다.

**전원코드 위에 무거운 물건을 올려 놓거나 코드가 제품바닥에 걸리지 않도록 주의해 주십시오.**

- 화재 및 감전의 원인이 됩니다. 수시로 전원코드 상태를 꼭 확인하십시오.

**전원코드를 임의로 연장하거나 연결하는 등 가공하여 사용하지 않습니다.**

- 감전 및 화재의 위험이 있습니다.

온도감지기, 밥솥 내부 및 열판 또는 내열 바깥 부위의 이물질, 열선, 기타온식물 등은 반드시 제거 후 사용하지십시오.

- 제품 사용 전 반드시 이물질 제거 상태 확인 후 사용하지십시오.
- 온도감지를 정확히 못하게 되므로 내출이 이상적용 및 화재의 원인이 됩니다.

전원플러그를 콘센트에서 떼거나 뽑는 손의 끝부분 반드시 제거한 후 전원플러그를 잡고 꺾거나 빼어 주십시오.

- 젓은 손으로 전원플러그를 뽑으면 감전의 원인이 될 수 있습니다.
- 무리하게 당겨 뽑으면 전원코드에 이상이 발생되어 누전 및 감전이 될 수 있습니다.

제품 이동시 전원코드를 이용하여 들어올리거나 잡아당겨서 이동하지 않습니다.

- 스토트 인한 화재의 원인이 될 수 있습니다.

## ⚠ 주의 (지시)

전원플러그를 뽑더라도 뚜껑 결합 손잡이를 항상 "고압" 위치로 돌려 주십시오.

- 취사나 요리 완료 후 내출이 뜨겁거나 뜨거운 밥이 남아 있을 경우 전원플러그를 뽑더라도 뚜껑을 닫고 뚜껑 결합 손잡이를 "고압" 위치로 돌리지 않으면 내부압력 때문에 제품의 변형이나 손상의 원인이 됩니다.
- 고압 메뉴 취사, 요리 및 보온 중에도 반드시 뚜껑 결합 손잡이를 "고압" 방향으로 돌려서 놓고 사용해야 주십시오.

취사나 요리가 끝난 뒤에는 반드시 본체에 고인물을 닦아 주십시오.

- 냄비 및 번식의 원인이 됩니다.
- 본체의 돌발이에 고인 물을 닦아 주십시오.

사용 전후 버튼이 눌러지지 않거나 작동이 되지 않을 경우 고객센터사로 문의해 주십시오.

요리 후에는 반드시 청소해 주십시오.

- 단열, 갈비팬 등의 요리 후 취사 및 보온을 하더라도 밥에 냄새가 배어 들 수도 있습니다.
- 내출뚜껑 세척시 거친 수세미나 금속성 수세미를 사용할 경우 코팅이 벗겨질 수 있으니 반드시 스폰지 또는 물기를 제거한 행주등 뒤어 주십시오.
- 내출, 내출뚜껑, 행주 등을 깨끗이 닦아낸 후 사용하지하십시오.
- 제품의 사용환경이나 방법에 따라 내출뚜껑의 코팅이 벗겨질 수 있습니다. 이런 경우 고객센터사로 문의해 주십시오.

취사 또는 요리 진행 중 자동증기 배출시 주의하십시오.

- 증기가 고속으로 배출되면서 튀어 나오는 소리가 나므로 놀라지 않도록 주의하십시오.
- 특히 어린이의 접근을 막아 주십시오. 화상의 원인이 됩니다.

환방 이외의 실용에는 변질하기 쉬운 것(쌀판, 혼식, 크로켓, 그라탱 등)이 있으므로 가능하면 보존하지 않습니다.

취사 또는 요리 진행 중 정전이 되면 자동증기 배출 장치가 작동하여 내용을 비산의 우려가 있습니다.

- 정해진 쌀 및 물의 양으로 취사해 주십시오.
- 특히, 물의 양이 규정보다 많으면 내용을 넘치는 원인이 됩니다.
- 증기조절감이 정적된 상태에서 취반을 하십시오.

갈비팬과 같이 빠지 있는 음식을 조리 시 별도의 용기에서 양념하여 올려 담아 주십시오.

- 내출 코팅이 손상되어 벗겨질 수 있습니다.
- 고열 과열에 의한 내출 코팅의 스크래치 및 벗겨짐이 발생할 경우에는 무상 서비스 기간 내라도 유상 처리됩니다.

전원플러그를 뽑을 때는 전원코드를 잡지마시고 꼭 전원플러그를 잡고 빼어 주십시오.

- 전원코드에 충격이 가면 감전 및 화재의 원인이 될 수 있습니다.

쌀은 별도의 용기에서 씻어서 옮겨 담아 주시고, 용기에 남은 쌀을 털어내기 위해 내출에 두드리지 않습니다.

- 고열 과열에 의한 내출 코팅의 스크래치 및 벗겨짐이 발생할 경우에는 무상 서비스 기간 내라도 유상 처리됩니다.

## ⚠ 주의 (금지)

내출을 다른 용도로 사용하거나 불위에 올리지 않습니다.

- 내출의 변형 및 코팅이 벗겨져 제품이 이상이 발생할 수 있습니다.

내출 코팅이 벗겨질 경우 고객센터사로 문의해 주십시오.

- 제품을 장기간 사용할 경우 내출 코팅이 벗겨질 수 있습니다.
- 거친 수세미나 금속성 수세미로 내출을 씻을 경우 코팅이 벗겨질 수 있으니 반드시 주방용 중성세제와 스폰지로 씻어 주십시오.
- 날카로운 사기, 칼, 숟가락, 차가리 등을 내출에 닿을 경우 내출 코팅이 벗겨질 수 있습니다.
- 고열 과열에 의한 내출 코팅의 스크래치 및 벗겨짐이 발생할 경우에는 무상 서비스 기간 내라도 유상 처리됩니다.

내출 세척용 권장 수세미(내출, 외출)

사용 가능	사용 불가능
연 수세미, 소문지 수세미, 쿠세미, 빗사 수세미	화면, 녹색 수세미(연필채, 칫솔, 수세미, 기타 금속 재질 수세미)

- 사용 불가한 수세미를 사용하실 경우 내출 코팅이 손상되어 벗겨질 수 있습니다.
- 고열 과열에 의한 내출 코팅의 스크래치 및 벗겨짐이 발생할 경우에는 무상 서비스 기간 내라도 유상 처리됩니다.

경사진 곳이나 울퉁불퉁한 곳에서는 사용하지 않습니다.

- 화상 및 제품 고장의 원인이 됩니다.
- 전원코드에 손이나 발, 기타 물체가 걸려 제품이 떨어지지 않도록 주의 하십시오.

사용 중에 이상한 소리나 냄새 또는 연기가 나면 즉시 전원플러그를 뽑고 내부 압력을 완전히 제거후 고객센터사로 문의해 주십시오.

고압 메뉴 취사나 요리 완료 후 또는 보온 시 뚜껑 결합 손잡이가 잘 돌려지지 않을 때 강제로 돌리지 않습니다.

- 화상 및 제품손상의 원인이 됩니다.
- 압력축을 찌그러뜨리기 완전히 배출되었는지 확인 후 뚜껑 결합 손잡이를 돌려주십시오.
- 취사나 요리 완료후 뚜껑을 열때 증기에 의한 화상의 우려가 있으므로 주의하십시오.

플라스틱이나 나무 소재의 주걱 이외에 금속성 소재의 주걱이나 스키어링을 받을 푸지 마십시오. 또한, 칼, 가위 등의 날카로운 금속성 주방도구를 내출에 넣어 보관하지 않습니다.

- 내출 코팅이 손상되어 벗겨질 수 있습니다.
- 고열 과열에 의한 내출 코팅의 스크래치 및 벗겨짐이 발생할 경우에는 무상 서비스 기간 내라도 유상 처리됩니다.

사용 중이거나 사용후에는 내출, 내부, 열판 및 압력축 등은 뜨거우므로 만지지 않습니다.

- 고열에 의해 화상을 입을 수 있습니다.
- 압력축이 찌그러뜨 증기에 의해 화상을 입을 수 있습니다.

뚜껑 결합 손잡이나 내출 손잡이를 잡고 제품을 열면 울리거나 위험합니다.

- 뚜껑 결합 손잡이나 내출 손잡이를 잡고 들어 올릴 경우 뚜껑이 열릴 우려가 있어 위험합니다.
- 제품 바닥 좌우측에 있는 홈을 양손으로 들어올려 안전하게 사용하지 않습니다.

교류 120V 이외에는 사용하지 않습니다.

- 감전, 화재의 원인이 될 수 있습니다.
- 제품이 정상적으로 작동하지 않습니다.

제품 밑에 깔판, 방석, 전기장판 등을 놓고 사용하지 않습니다.

- 화재 및 변형의 원인이 됩니다. 수시로 제품 상태를 꼭 확인하십시오.

취사나 요리시에는 지정된 용량을 초과하여 요리하지 않습니다.

- 요리시간에 지정된 용량을 초과할 경우 압력축 및 스토트 챔프로 내용을 넘치는 원인이 됩니다.

취사, 보온, 지정된 메뉴 이외의 식재, 미역국, 커리, 기름으로 튀기는 요리 등 다른 용도로 사용하지 않습니다.

- 고장 및 냄비의 원인이 됩니다.

사용하지 않을 때는 전원플러그를 콘센트에서 뽑아 주십시오.

- 절연 성능 저하로 인해 감전, 누전, 화재의 원인이 될 수 있습니다.

제품에 심한 충격을 주거나 떨어뜨리지 않습니다.

- 제품 고장 및 안전상의 문제가 발생할 수 있습니다.
- 고열 과열에 의한 내출 코팅의 스크래치 및 벗겨짐이 발생할 경우에는 무상 서비스 기간 내라도 유상 처리됩니다.

# 安全警告

- “安全警告”是为了预防事故的发生，请正确使用产品，并遵守安全警告事项。
- “安全警告”有“警告”和“注意”两种区分，“警告”和“注意”有下列意义。



**警告**

未遵守警告事项时，  
可能会发生严重人身伤害。



**注意**

未遵守注意事项时，  
可能会有轻伤或产品受损。



此标记是指在特定条件下，对可能发生危险事故的符号。  
为避免发生危险，请详细阅读使用说明书并按照指示使用。



此符号表示“禁止”某种行为。



此符号表示“指示”某种行为。



**警告**

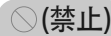

**(禁止)**

使用中切勿触摸或把脸靠近压力锥和蒸汽排出孔。

- 会导致烫伤，特别注意勿让儿童靠近。
- 高温蒸汽很烫，切勿将手或脸直接靠近。

本产品要避免阳光直射，严禁靠近煤气炉，电热器具等。

- 有漏电，触电的危险及有变形或变色的可能。
- 严禁电源线靠近热器具，避免电源线熔化造成火灾或触电的危险。

严禁私自拆卸或改装。

- 发生火灾或触电的可能。
- 除专业修理人员外，请勿自行拆卸或改装。
- 修理时请先与指定维修中心联系。

必须使用额定电流15A以上120V交流电专用插座，不宜与其他电器共用一个插座。

- 会产生发热，火灾，触电的可能。
- 电源插头上有异物时，请先清洁干净后使用。
- 插座的延长线必须使用额定电流15A以上的。

严禁在有水的地方或户外使用。

- 有漏电或触电的危险。
- 如水渗入机体内部时，请拨打服务热线咨询。

严禁在灰尘多或有化学物品的地方使用。

- 严禁在产品周围使用可燃性气体或易燃物品。
- 发生火灾或爆炸的可能。

电源线破损或插头松动时，请停止使用并及时更换。

- 产品使用中，因使用不当电源线表皮有破损时会产生触电或发生火灾，请及时确认电源线及插座的完整状态。
- 电源线有破损时，为避免发生危险，请停止使用并与产品销售店或指定维修中心联系更换。

严禁用水冲洗机体或避免内部进水。

- 会有漏电，触电，火灾的可能。
- 产品内渗入水时，切断电源，停止使用，请拨打服务热线咨询

严禁将抹布等异物放在压力锥和蒸汽排出口上。

- 变形或变色的可能。
- 产品故障及火灾的可能。

切勿使用变形内锅或其他非专用内锅。

- 内锅发热时会产生异常现象或引起火灾。
- 若不小心碰撞内锅或内锅变形时，请拨打服务热线。

无内锅状态下请勿使用。

- 触电及故障的可能。
- 严禁无内锅时放米和水。
- 机体内进入水或米粒时，请拨打服务热线。

煮饭或料理进行时按锅盖开启按钮，锅盖结合手把调成绝对“无压”不要转动。

- 强制开始的情况因压力导致烧伤及爆炸的危险。
- 煮饭或料理完成后完全排出蒸汽的状态启用结合手把。

把锅盖结合手把调成“高压”位置后放入内锅不要关闭。

- 以关闭装置及内锅的破损，变形导致蒸汽流失或爆炸的危险。

无内锅的情况下请将蒸盘，金属性物质等其它物质放进产品里使用。(特别注意儿童)

- 发生火灾或触电的可能。

本产品严禁儿童独自使用。请放置在儿童触及不到的地方。

- 烫伤或触电的可能。

产品内请勿喷酒或投入化学物品。

- 烫伤或火灾的可能。
- 当产品内进入蟑螂或其他昆虫时，请咨询代理店或服务中心。

严禁用针或金属物质堵塞排气口或产品缝隙。

- 烫伤或触电的可能。
- 清洁用针除了清理蒸汽排出孔外，不得插入产品缝隙或其它孔里。

电源线不宜强行弯曲，捆绑或拉伸。

- 触电或因短路发生火灾的可能。

注意不要让动物把插头及电源线咬断或避免受到锋利金属物体的冲击。

- 短路，触电或发生火灾的可能。

电源插头上有异物时，请用干抹布擦净后使用。

- 短路或发生火灾的可能。

煮饭或料理进行中时不要打开锅盖。

- 就算料理中煮沸或蒸汽漏失也不要先开始锅盖。
- 强制开始锅盖的话因内物飞散会导致烧伤。
- 煮饭或料理进行时不得已把锅盖开始的情况的话按取消按钮后(内锅温度高的话2秒)确认一下内部压力完全消失后开启。
- 必要时终止产品使用拔掉电源插头后询问顾客咨询室。

不要把电源插头拔去。

- 触电及火灾的危险。

## 警告 指示

禁止将产品放在米桶及多层柜上使用。

- 电源线夹在缝隙里,可能会引起触电或发生火灾。
- 在米桶及多层柜上使用可能会导致产品损坏或引起火灾。

请勿将重物放在电源线上面或避免被压到产品底部。

- 有可能会发生火灾或触电,请随时确认电源线放置状态。

勿将电源线进行加工或随意连接延长线使用。

- 有触电或发生火灾的危险。

温度感应器,电热盘及内锅底部要保持清洁。

- 温度感应器受损,可能会发生故障及火灾。

擦干手,再插,拔插头。

- 用湿手插,拔插头时会发生触电。
- 电源插头拔出时,切勿直接拽电源线拔出。

移动产品时,请勿拽电源线移动产品。

- 会因断路有发生火灾的可能。

## 注意 指示

要是拔掉电源插头的话把锅盖把手把一直转到“高压”位置。

- 煮饭或料理完成后内锅发烫或剩余热饭情况的话拔掉电源插头要是内锅结合手把没转到“高压”位置的话因内部压力导致产品的变形和损伤的原因。
- 高压菜单煮饭,料理及保温中也必须把锅盖把手把转到“高压”方向后使用。

煮饭完成后,请擦净积水部的水。

- 会产生异味或变色。
- 请擦去产品积水部的水。

使用前,按键无法按动或产品不能动作时,请拨打售后服务电话咨询。

煮饭或料理中当发生停电时,自动蒸汽排出装置会自动启动,可能会有汤汁溢出现象。

- 请在安装蒸汽帽的状态下进行煮饭。
- 添加的水量超出规定容量时,会有溢出现象。
- 请按使用说明书的煮饭方法正确煮饭。

使用完毕后产品要清洁干净。

- 料理结束后,未清理干净时会出现异味。
- 使用硬刷子,钢丝球清洗内锅时,内锅涂层会脱落,请用中性洗涤剂 and 海绵清洗。
- 根据产品的使用环境和方法的不同,内锅涂层会有脱落现象。

蒸汽自动排出时,请注意。

- 蒸汽高速排出时,伴有较大的排气声,注意不要受到惊吓。
- 严禁儿童靠近,会烫伤。

除白米饭外容易变质的(杂粮,豆类饭,油炸丸子等)尽量不要进行保温。

拔插头时,必须抓住插头拔出,请勿强行拽拔电源线拔出。

- 可能会发生触电,漏电或火灾的危险。

跟炖牛排骨一样调理有骨头的食物时用别的容器调料完后盛装。

- 损伤内锅涂层会抹掉。
- 因顾客过失发生内锅涂层刮伤及抹掉的情况免费服务期间也是有偿处理。

米饭在别的容器洗完盛装后,为了移除剩余容器里的米不要敲内锅。

- 因顾客过失发生内锅涂层刮伤及抹掉的情况免费服务期间也是有偿处理。

## 注意 (禁止)

勿将内锅放在火源上或用于其他用途。

- 内锅变形或涂层会脱落。

内锅涂层脱落时,请与售后服务中心联系。

- 长时间使用产品时,内锅涂层因老化有轻微脱落,请及时拨打服务热线进行更换。
- 用硬刷子,钢丝球清洗内锅时,涂层会脱落,要用中性洗涤剂 and 海绵清洗。
- 请勿将餐具(叉子,勺子,筷子等)放入内锅中清洗,会导致涂层脱落。

清洗内锅建议用清洁球(内侧、外侧)。

可使用可	不可使用
棉质清洁球、海绵、超细纤维、网纱清洁球	蓝色、绿色清洁球(研磨剂材质)、铁制、钢制清洁球、其他金属材料清洁球

- 用不可使用的清洁球清洗时,可能会出现内锅涂层损坏、脱落现象。

本产品不宜在倾斜或凹凸面上使用。

- 会有烫伤或发生故障的可能。
- 产品工作中,切勿碰电源线。

使用时如有异常响声或有异味时,请立刻切断电源,推动压力锥,待蒸汽完全排出后,咨询代理店或售后服务中心。

使用时不要超出限定容量。

- 会有米汤溢出或出现故障。

切勿靠近磁性强的物体。

- 可能会产生安全上的问题。
- 可能会导致故障。

勿使产品跌落或受冲击。

- 会发生故障及安全性的问题。

煮饭完成后,结合手柄不易拧开时,不要强行拧开。

- 会烫伤或会有产品受损现象。
- 推动压力锥,等蒸汽完全排除后再打开。
- 煮饭完成后打开锅盖时,注意避免被蒸汽烫伤。

除了塑料或木材的饭勺不要用金属性材质饭勺或勺盛米饭。而且,刀,剪刀等锋利的金属性厨房工具不要在内锅里保管。

- 内锅涂层损伤会导致抹掉。
- 因顾客过失发生内锅涂层刮伤及抹掉的情况免费服务期间也是有偿处理。

使用中或使用后锅体温度很高,切勿触摸内锅,加热盘,产品内部及压力锥。

- 会有烫伤的危险。
- 产品工作中若压力锥倾斜,会被喷出的蒸汽烫伤。

请勿用锅盖结合手柄或内锅把手移动产品。

- 会产生危险,请利用产品底部的移动凹槽移动产品。

本产品只限使用 120V 交流电源。

- 可能会导致触电或发生火灾。
- 产品不能正常工作。

本产品要放置于较阔的水平台面上,切勿放在坐垫或电热毯上使用。

- 可能会导致变形或发生火灾。

煮饭或料理时不要超过指定的容量。

- 超过料理内指定的容量的话压力锥和软蒸汽帽内物溢出的原因。

本产品只适用于做饭,保温及指定用途,严禁他用。

- 会产生异味或变色。

不使用时,请拔掉插头。

- 以避免发生触电及火灾。

# MESURES DE SÉCURITÉ

- Lisez attentivement le guide de sécurité du produit qui suit afin d'éviter les accidents et/ou les dangers graves.
- « Avertissement » et « Attention » diffèrent comme suit :

## **Avertissement**

Cela signifie que l'action qui est décrite peut entraîner la mort ou une blessure grave.

## **Attention**

Cela signifie que l'action décrite peut entraîner des blessures ou des dégâts matériels.



• Ce symbole vise à rappeler et à alerter que quelque chose peut entraîner des problèmes dans la situation donnée.

• Veuillez lire et respecter l'instruction afin d'éviter toute situation dangereuse



• Indique une interdiction



• Indique une instruction.

## **Avertissement**

## **Ne pas**

**Ne recouvrez pas la sortie de vapeur automatique ou le poids de pression avec votre main ou votre visage.**

- Cela peut entraîner des brûlures.
- Faites particulièrement attention à le mettre hors de portée des enfants.

**N'utilisez pas le cuiseur près de ce qui est chaud comme une cuisinière, une cuisinière à gaz ou la lumière directe du soleil.**

- Cela peut causer un choc électrique, un incendie, une déformation, un dysfonctionnement ou une décoloration. Veuillez vérifier régulièrement le cordon d'alimentation et la prise.

**Ne modifiez pas, ne remontez pas, ne démontez pas ou ne réparez pas cet appareil.**

- Cela peut entraîner un incendie, un choc électrique ou des blessures.
- Pour le faire réparer, contactez le revendeur ou le centre technique.

**Utilisez une prise individuelle avec un courant nominal supérieur à 15A.**

- L'utilisation de plusieurs lignes sur une seule prise peut provoquer une surchauffe ou un incendie.
- Veuillez vérifier fréquemment le cordon d'alimentation et la prise.
- Utilisez une rallonge avec un courant nominal supérieur à 15A.

**Soyez particulièrement attentifs à l'eau ou aux produits chimiques.**

- Cela peut causer un choc électrique ou un incendie.

**N'utilisez pas le cuiseur à riz dans un endroit qui retient la poussière ou en présence de produits chimiques**

- N'utilisez aucun gaz inflammable ou produit inflammable près du produit.
- Cela peut entraîner une explosion ou un incendie.

**N'utilisez pas un cordon d'alimentation endommagé, une fiche ou une prise mal fixée.**

- Veuillez vérifier régulièrement si le cordon d'alimentation est endommagé.
- Des dégâts importants peuvent entraîner un choc électrique ou un incendie.
- Si la fiche est endommagée, contactez le revendeur ou un centre technique.

**Ne nettoyez pas le produit avec de l'eau ni ne versez de l'eau dans le produit.**

- Cela peut entraîner un choc électrique ou un incendie.
- Si le produit est en contact avec de l'eau, veuillez séparer le cordon d'alimentation et contactez le revendeur et le centre technique

**Ne recouvrez pas la sortie de vapeur automatique ou le poids de pression avec un chiffon, une serviette ou un tablier etc.**

- Cela peut entraîner une déformation ou une panne.
- Cela peut entraîner une explosion due à la pression.

**N'utilisez pas de cuves de cuisson qui ne sont pas conçues pour le cuiseur.**

**N'utilisez pas une cuve de cuisson anormale et n'utilisez pas l'appareil sans la cuve de cuisson.**

- Cela peut entraîner un choc électrique ou un incendie.

**N'utilisez pas l'appareil sans la cuve de cuisson**

- Cela peut provoquer un choc électrique ou un dysfonctionnement.
- Ne mettez pas de riz ni d'eau sans la cuve de cuisson à l'intérieur.
- Si du riz ou de l'eau s'infilte, ne retournez pas le produit et ne le secouez pas, veuillez contacter le revendeur ou le centre technique

**Ne pas appuyer sur le bouton de serrage ou ne pas tourner la poignée de verrouillage/déverrouillage en mode « Aucune pression » pendant la cuisson.**

- Si l'appareil est ouvert de force, il peut provoquer des brûlures et une explosion.
- Utiliser la poignée de verrouillage/déverrouillage une fois que la vapeur est complètement évacuée.

**Tournez la poignée de verrouillage/déverrouillage en position « haute pression » et ne fermez pas le couvercle avec la casserole interne à l'intérieur de la machine.**

- La déformation ou l'endommagement de la serrure et de la casserole interne peut provoquer des fuites de vapeur ou une explosion.

**N'insérez pas d'objets en métal tels que des épingles et des fils ou toute autre substance extérieure dans la sortie d'évacuation de vapeur automatique ou toute autre ouverture.**

- Cela peut entraîner un choc électrique ou un incendie.
- Faites tout particulièrement attention de garder l'appareil hors de portée des enfants.

**Gardez le cuiseur hors de portée des enfants.**

- Cela peut provoquer des brûlures, un choc électrique ou des blessures.

**Ne vaporisez pas et n'utilisez pas d'insecticides ou de produits chimiques.**

- Cela peut entraîner un choc électrique ou un incendie.
- Si des cafards ou d'autres insectes pénètrent dans le cuiseur, veuillez contacter un revendeur ou un centre technique

**Ne laissez pas des substances étrangères telles qu'une aiguille, une épingle de nettoyage, ou du métal entrer et ne bloquez pas le conduit d'arrivée/d'évacuation ou l'ouverture.**

- Cela peut entraîner un choc électrique ou un incendie.
- Ne mettez pas une épingle de nettoyage dans l'ouverture ou le trou du produit sauf pour nettoyer la sortie de vapeur.

**N'ouvrez pas le couvercle supérieur lors de la phase de chauffage et de la cuisson.**

- Cela peut entraîner des brûlures.
- Si vous avez besoin d'ouvrir le couvercle lors de la cuisson, maintenez appuyé le bouton cancel (annuler) pendant deux secondes et vérifiez que la vapeur interne s'est complètement évacuée en retournant le poids de pression.

**Ne pliez pas, n'attachez pas et ne tirez pas le cordon d'alimentation de force**

- Cela peut provoquer un choc électrique ou un court-circuit entraînant un incendie. Veuillez vérifier fréquemment le cordon d'alimentation et la prise.

**Ne débranchez pas ni ne branchez sans arrêter le cordon d'alimentation.**

- Cela peut entraîner un choc électrique ou un incendie

**Faites attention à ce que la fiche et le cordon d'alimentation ne soient pas entrecroqués par des attaques d'animaux ou par des matériaux métalliques tranchants.**

- Les dégâts dus à des impacts peuvent provoquer un choc électrique ou un incendie. Veuillez vérifier fréquemment le cordon d'alimentation et la prise.

**Retirez une substance étrangère sur le cordon et la fiche à l'aide d'un chiffon propre.**

- Cela peut provoquer un incendie. Veuillez vérifier fréquemment le cordon d'alimentation et la fiche.

# MESURES DE SÉCURITÉ

## **⚠ Avertissement**

## **! Se rappeler**

**N'utilisez pas l'appareil sur un coffre à riz ou une étagère**

- Ne placez pas le cordon d'alimentation entre des meubles. Cela peut provoquer un choc électrique entraînant un incendie.
- En cas d'utilisation sur du mobilier, faites attention à l'évacuation de la vapeur car cela peut provoquer des dégâts, un incendie et/ou un choc électrique.

**Ne placez pas de choses lourdes sur le cordon d'alimentation**

- Cela peut entraîner un choc électrique ou un incendie.
- Veuillez vérifier fréquemment le cordon d'alimentation et la fiche.

**Ne changez pas, ne rallongez pas ni ne branchez le cordon d'alimentation sans l'avis d'un expert technique**

- Cela peut entraîner un choc électrique ou un incendie.

**Nettoyez la poussière ou toute substance étrangère sur le capteur de température et la cuve de cuisson.**

- Cela peut provoquer un dysfonctionnement du système ou un incendie

**Ne branchez pas et ne retirez pas le cordon d'alimentation avec les mains mouillées.**

- Cela peut provoquer un choc électrique

**Ne déplacez pas le produit en tirant ou en utilisant le cordon d'alimentation.**

- Un court-circuit électrique pourrait provoquer un incendie.

## **⚠ Attention**

## **! Se rappeler**

**Tournez la poignée de verrouillage/déverrouillage à la position « Haute pression » lorsque l'appareil est débranché.**

- La pression interne dû à la cuisson du riz ou à la casserole interne peut provoquer des déformations ou des dommages, si la poignée de verrouillage/déverrouillage n'est pas en position « verrouillée ».
- Assurez-vous de verrouiller la poignée de verrouillage/déverrouillage pendant la cuisson et le réchauffement à haute pression.

**Essayez toute l'eau en excès sur le cuiseur après la cuisson.**

- Cela peut entraîner des odeurs ou une décoloration. Essayez l'eau résultant de la condensation.

**Veuillez contacter un revendeur ou un centre technique lorsqu'un bouton du produit ou le produit lui-même ne fonctionne pas correctement.**

**En cas de coupure de courant durant la cuisson, la vapeur du cuiseur à riz est évacuée automatiquement. La qualité du riz est par conséquent inférieure à la normale.**

- Veuillez démarrer la cuisson avec la quantité d'eau et de riz indiquée.
- L'eau peut déborder si la quantité d'eau dans la cuve de cuisson dépasse le niveau d'eau recommandé.
- Veuillez démarrer la cuisson avec le capot de régulation de la vapeur complètement mis en place.

**Lorsque vous cuisinez des aliments avec des os, comme des côtes levées braisées, veuillez assaisonner la viande dans une autre assiette.**

- Le revêtement de la casserole interne peut s'user.
- Si le revêtement de la casserole interne s'égraine ou s'use à cause d'une erreur du client, vous devez payer la réparation même pendant la période de service de réparation gratuite.

**Veuillez nettoyer le corps ainsi que les autres parties après la cuisson.**

- Après avoir fait cuire de la soupe au poulet, différents plats etc. il se peut que l'odeur soit imprégnée.
- Nettoyez le compartiment du tour, la plaque supérieure de chauffage et la cuve de cuisson à chaque fois que vous faites cuire avec l'un d'entre eux.
- Cela peut entraîner une altération ou des odeurs.
- Utilisez un essie-tout sec ou une éponge pour nettoyer la cuve de cuisson, car les surfaces dures rugueuses ou celles en métal sont abrasives pour le revêtement.
- En fonction des méthodes d'utilisation ou des circonstances propres à l'utilisateur, le revêtement de la cuve de cuisson peut se détacher.
- Veuillez contacter le service client dans ces cas de figure. Veuillez ne pas tirer de force l'évent à vapeur propre.

**Faites attention lorsque la vapeur est évacuée**

- Ne soyez pas surpris lorsque la vapeur est évacuée.
- Veuillez conserver le cuiseur hors de portée des enfants.

**N'utilisez si possible la fonction de chauffage que pour la cuisson de riz blanc. Les autres aliments se décolorent facilement**

**Lorsque vous retirez la fiche d'alimentation, ne tirez pas sur le cordon d'alimentation. Veuillez retirer en toute sécurité la fiche d'alimentation**

- Si vous faites prendre un impact au cordon d'alimentation, cela peut entraîner un choc électrique ou un incendie.

**Veuillez rincer le riz et le placer dans une autre assiette et ne frappez pas sur la casserole interne pour retirer le reste de riz dans l'assiette.**

- Si le revêtement de la casserole interne s'égraine ou s'use à cause d'une erreur du client, vous devez payer la réparation même pendant la période de service de réparation gratuite.

## **⚠ Attention**

## **⊘ Ne pas**

**Ne pas utiliser la casserole interne à des fins diverses. Et ne pas chauffer la casserole interne sur une cuisinière à gaz.**

- Cela peut entraîner une déformation de la casserole interne.
- Cela peut entraîner le déversement du revêtement intérieur.

**Veuillez contacter le service client si le revêtement de la cuve de cuisson s'enlève.**

- Il se peut que le revêtement s'use après une longue utilisation.
- Lors du nettoyage de la cuve de cuisson, n'utilisez pas de tampon à recycler dur ou métallique, de brosse, d'abrasifs métalliques etc.

**Type de laveur recommandé pour nettoyer la casserole interne (intérieur, extérieur)**

Disponible	Non disponible
Eponge en coton, éponge, récureur à fillet, de type extra fin	Laveur bleu, vert (de type abrasif), éponge en soie nonopile, aère récureur métallique

- Si vous utilisez une éponge non mentionnée, le revêtement de la casserole interne peut s'user.
- Si le revêtement de la casserole interne s'égraine ou s'use à cause d'une erreur du client, vous devez payer la réparation même pendant la période de service de réparation gratuite.

**Ne placez pas l'appareil sur une surface irrégulière ou inclinée.**

- Cela peut provoquer des brûlures ou des pannes.
- Faites attention à installer le cordon d'alimentation de façon à ce qu'il passe sans interruption.

**Veuillez contacter un revendeur ou un centre technique en cas d'odeur ou de fumée inhabituelle.**

- Débranchez tout d'abord le cordon d'alimentation.
- Puis contactez le revendeur ou le centre technique.

**N'utilisez pas l'appareil au-delà de la capacité maximum.**

- Cela peut provoquer un débordement ou une panne.
- Ne faites pas cuire au-delà de la capacité mentionnée pour la cuisson d'une soupe au poulet et d'un congé

**N'utilisez pas le cuiseur près d'un champ magnétique.**

- Cela peut provoquer des brûlures ou une panne

**Ne laissez pas tomber le cuiseur et ne le soumettez pas à des chocs.**

- Cela peut entraîner un problème de sécurité

**Après avoir fini la cuisson, n'essayez pas d'ouvrir le cuiseur de force avant que la vapeur ne soit complètement évacuée.**

- La vapeur chaude ou tout autre élément chaud à l'intérieur du cuiseur peut provoquer des brûlures.
- Ouvrez le couvercle supérieur avec prudence après la cuisson afin d'éviter la vapeur et des brûlures présentant un danger.

**Ne mettez pas le riz dans une assiette en utilisant une cuillère métallique ou une cuillère à riz au lieu d'une cuillère à riz en plastique ou en bois.**

- Cela peut endommager la surface de la casserole interne et le revêtement peut s'user.
- Si le revêtement de la casserole interne s'égraine ou s'use à cause d'une erreur du client, vous devez payer la réparation même pendant la période de service de réparation gratuite.

**Ne touchez pas la surface métallique de la cuve de cuisson et le poids de pression après la cuisson et la phase de chauffage.**

- Cela peut entraîner des brûlures.
- La vapeur chaude restante peut provoquer des brûlures quand vous appuyez sur le poids de pression durant et juste après la cuisson.

**Ne tenez pas le cuiseur par la poignée de la cuve de cuisson**

- Cela peut entraîner des problèmes ou être dangereux. Des poignées amovibles sont disposées en bas à droite et sur le côté gauche du cuiseur. Tenez les poignées à deux mains et déplacez-le avec précaution.

**Utilisez seulement une tension alternative de 120 V.**

- Autrement, cela peut provoquer un choc électrique ou un incendie.
- Cela peut provoquer des dysfonctionnements.

**Utilisez le produit sur une surface plane. N'utilisez pas le produit sur un coussin. Veuillez éviter d'utiliser le produit dans un endroit qui n'est pas stable ou il risquerait de tomber**

- Cela peut entraîner un dysfonctionnement ou un incendie.

**Veuillez vérifier fréquemment le cordon d'alimentation et la prise.**

**Ne pas dépasser la quantité indiquée pendant la cuisson.**

- Si vous dépassez la quantité d'aliment indiquée dans la recette, cela peut causer un débordement en raison du poids de pression et du couvercle léger.

**Veuillez utiliser le cuiseur dans le bid dans lequel il a été conçu.**

- Cela peut provoquer un dysfonctionnement ou une odeur.

**Veuillez débrancher la prise lorsque vous n'utilisez pas le produit**

- Cela peut provoquer des chocs électriques ou un incendie.

# PARTS IDENTIFICATION

Soft Steam Cap

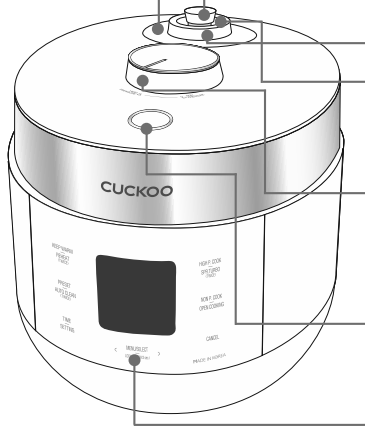

Pressure Weight

Always keep it horizontal. It stabilizes steam inside of the oven. If the pressure weight is twisted, it will release steam.

TWIN PRESSURE

Automatic Steam Exhaust Outlet (Solenoid Valve)

When finished cooking or during warming, steam is automatically released.

Lock/Unlock Handle

If the Lock/Unlock Handle is turned to "high pressure" position, you can cook with high pressure, and if the handle is turned to "non pressure" position, you can cook with non pressure.

Clamp Knob

To open the lid, turn the Clamp Knob from "high pressure" to "non pressure" and then press the Clamp Knob.

Control Panel

Pressure Packing

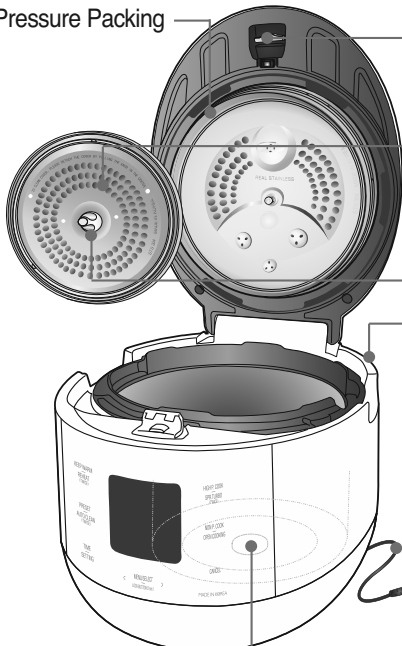

Lid Assy

Pot Handle

DET. cover

Inner Pot

DET. Cover Holder

Condensation Collector

Empty the water out of a drain dish after cooking or warming. Leaving water in the drain dish will result in unpleasant odors.

Power Cord

Power Plug

The plug type may vary in appearance. (U.S. 120V)

Temperature Sensor

## Accessories



Manual & Cooking Guide



Rice Scoop



Rice Measuring Cup

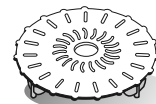

Steam Plate

(Steam plate can be purchased separately at Cuckoo service center.)



Cleaning Pin  
(Attached on the bottom of the unit)

## Detachable Inner Lid & Pressure Packing

After cleaning the inner lid, secure it back onto the lid.

Unless detachable cover is mounted, preset cooking cannot be done. (Alarm may sound while keeping warm.)

- Clean the detachable cover often with regular use to prevent unpleasant odor and product damage over time.
- Wipe the body and cover clean with a dry towel. Do not use harsh chemicals or detergents while cleaning the cooker. Starch may be remain, however there is no health risks.
- Do not put materials like screws into holes on the detachable cover. Check the back cover and front cover.

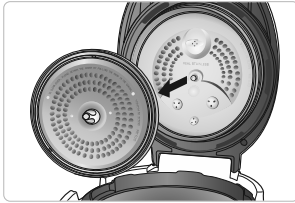

- ① Pull the detachable cover out toward you while gripping onto the edges.

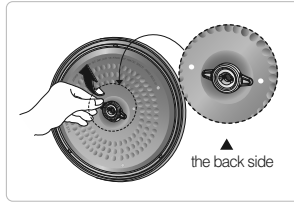

- ② When cleaning the detachable cover, hold and pull out the both sides of the cover, then separate the handle and the rubber packing.

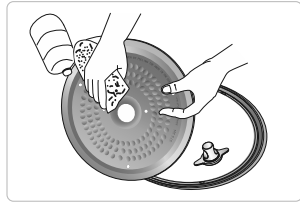

- ③ Clean the lid with a soft sponge and warm, soapy water.

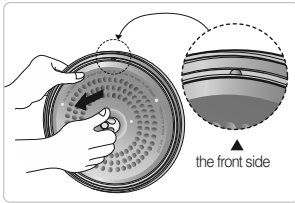

- ④ Please put the detachable cover.

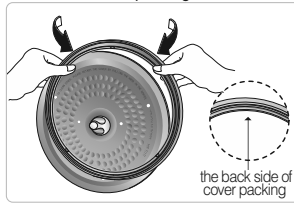

- ⑤ To replace the silicone ring back onto the inner lid, stretch the silicone ring slightly and place the inner lid inside of the ring.

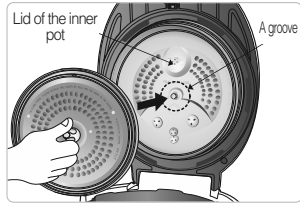

- ⑥ Put back the pressure cover by pressing the cover handle after fitting the handle into the groove indicated.

### Correct example

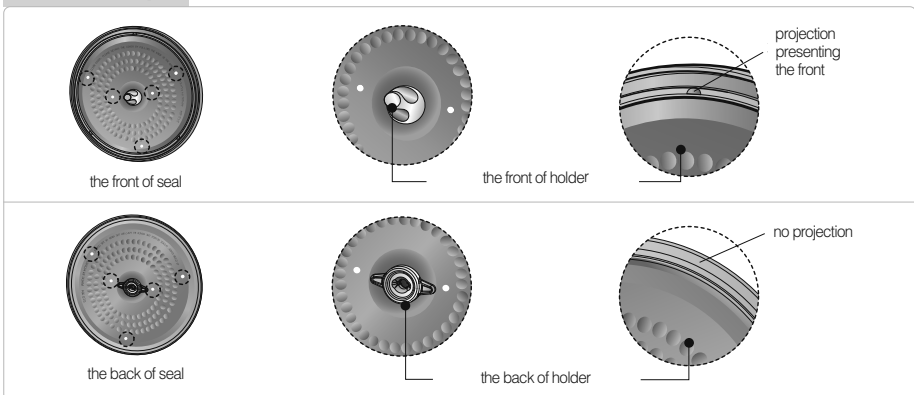

- ※ Do not put any other objects like screws into hole of detachable cover.
- ※ Check the back cover and front cover.

# HOW TO CLEAN



## INNER POT

Wash the inner pot using a soft sponge and warm, soapy water. Be sure to clean all surfaces to rid of any food residue.



## LID

If there is water or food residue on the lid, wipe clean with a damp cloth, using caution around electrical parts.



## OVEN PACKING

Wipe the inner lid clean with a damp cloth, using caution to avoid any and all electrical parts.



## DRAIN DISH

Pour out any excess water or liquids from the condensation collector then wipe clean with a damp cloth.



## INNER BODY

Wipe the temperature sensor clean with a dry cloth.



## CONTROL

If food or liquid has spilled on the control panel or digital display, wipe clean with a cloth.



## MAIN UNIT

Wipe the main unit with a damp cloth.

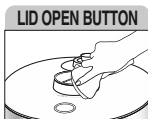

## LID OPEN BUTTON

Wipe around the lid release button with a damp cloth to remove any spilled foods or liquids.

### ※ Caution

- Do not clean the inner pot with any sharp cutlery inside (fork, spoon, chopsticks, etc.).
- The coating of the inner pot may peel off.

## Cleaning the Condensation Collector

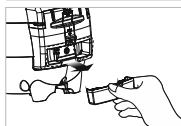

1 Remove the condensation collector from the cooker.

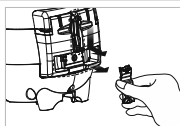

2 Separate the condensation collector cap by pushing it down.

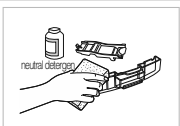

3 Wash the condensation collector and cap with a neutral detergent.

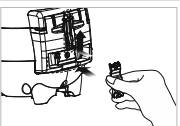

4 Replace the condensation collector cap into the cooker.

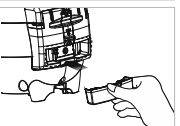

5 Insert the condensation collector by firmly pressing it into the cooker as shown in the image above.

## Cleaning the Pressure Weight Nozzle

### Pressure Weight/ Double motion valve

The cooker might not function properly if the steam valve and the double motion valve are clogged, be sure to remove any foreign substances in the valve with the cleaning pin before and after cooking. In order to remove any foreign substances in the double motion valve, please regularly use the Automatic Sterilization. (refer to 25P)  
Please regularly check if the hole of steam exhaust outlet is clogged or not.  
※ The appearance of the Pressure Weight may differ from the picture.

### Cleaning Soft Steam Cap

Separate the cap and wash it with a sponge and neutral detergent. Wipe out any remaining water or moisture on the lid with a cloth.

### <How to clean the Pressure Weight and Steam Valve >



1 Turn the Lock/Unlock Handle to "high pressure" and turn the Pressure Weight counter-clockwise while pulling it up until it comes out.

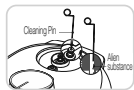

2 Puncture the clogged valve hole with the cleaning pin (Attached on the bottom on the unit).

※ Never use the cleaning pin for any other uses and do not attempt to poke any other holes of the cooker with the cleaning pin. They are safety device.



3 Reassemble the Pressure Weight by turning it clockwise.

4 When the Pressure Weight is properly reassembled, it will revolve freely.

Wash the Inner Pot and accessories with neutral detergent and a sponge.





The all-stainless cover is not only delamination-free and easy to clean, but it also lasts long, In addition, CUCKOO's special stainless CSV-a CUCKOO's patented technology, improves the product's durability and makes it easier to clean.

## How to install the Double Motion Packing (Pressure Packing)

- Proper maintenance of the pressure packing helps keep high airtightness, adds durability to packing and ensures the taste of the food.
- Read the directions below carefully to install your packing properly.

### 1 How to remove and clean the pressure packing



- ① Unplug the power cord and wait until the pot cools down before opening the lid.
- ② To remove the pressure packing, hold it as shown in the picture above and pull it out.
- ③ After hand washing it with a neutral cleaning liquid and a sponge, wipe it clean with a well wrung dish cloth.

### 2 How to Reassemble Pressure Packing

► Figure.1

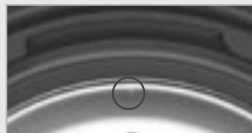
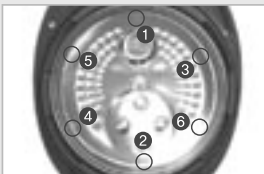

Standard notches on the Inner Pot lid.

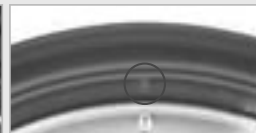

Standard points on the pressure packing.

- First match the standard notches on the Inner Pot lid with the standard points on the pressure packing following the numerical order (1, 2, 3, 4, 5, 6). Then, press the outer rim of the packing to insert it into the groove. To reassemble the pressure packing follow the order described below:

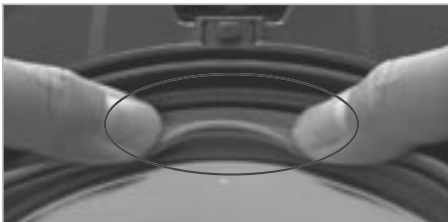

- ① As the Figure 1 shows, put the point #1 on the pressure packing with the standard notch #1 on the Inner Pot lid together before pressing the outer rim of the packing to insert it into the groove. Repeat with points #2 to #6.
- ② After matching the standard points 1 to 6, press the rest of the packing into the groove by pushing on its outer rim.

# HOW TO CLEAN

## 3 How to double check whether the packing is well assembled



Since a badly assembled packing can cause the rice to be half-cooked or burned by steam leakage, double check the packing thoroughly as described below.

### ① Visual inspection

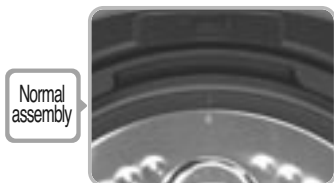

Normal assembly

• check the entire circumference carefully for any crack or damage between the Inner Pot lid and the pressure packing.

(look for parts sticking out of the inner)

(look for parts sticking out of outer rim)

(look for parts sticking out of damaged parts)



Abnormal assembly

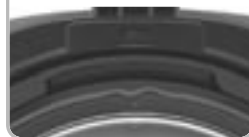

### ② Physical inspection

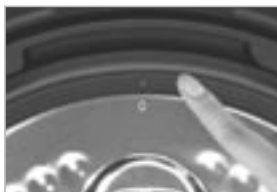

• Check if the pressure packing is thoroughly put into the groove by rubbing the inside rim of the packing with a finger around the entire circumference as shown in the picture above.



• Check if the pressure packing is properly put into the groove of the Inner Pot lid by pushing the outer rim with a finger around the entire circumference as shown in the picture.



• Check if the pressure packing is thoroughly put into the groove by pushing the inside of the rim packing with a finger around the entire circumference as shown in the picture.

### ③ Water boiling test

- Pour water in the Inner Pot up to water level 2 (for "Rice") and press the Menu/Selection button to select the self-cleaning mode. Then push the HIGH P COOK/TURBO button.
- Within 10 minutes, the pressure regulator weight will start rattling and hissing while emitting steam. If there is no steam coming out from the pot other than through the pressure regulator weight the packing has been properly installed.
- If steam comes out from other parts, stop the test and pull out the power cord. Wait until the pot cools down before removing the pressure packing from the lid. Once reinstalled repeat the boiling test.
- For a more precise water boiling test, you can wrap plastic around the circumference of the closed lid. By doing so, you can easily check where the steam leakage is.

Normal assembly



Abnormal assembly



• If you still have a problem with reassembling the packing, please contact our Customer Service.

## How to Clean the Soft Steam Cap

\* Do not touch the surface of the soft steam cap right after cooking. You can get burned.



❶ Pull off the soft steam cap as shown in the image above by grasping the dented part with your fingers and pulling to the side while lifting gently.

❷ Disassemble the hook on the front by pressing in the direction of the arrow and wash it with a sponge and neutral detergent. After cleaning, please assemble the parts in order.  
\* Be sure that the inserted side of the Packing is the correct side of it.

❸ To reassemble the Soft Steam Cap, fit the cap to the bump part, and then press the hook in the direction of the arrow.

❹ When installing the soft steam cap, insert the cap firmly by pressing it in the direction as shown above.

## How to Use the Dial

1. Make sure to close the lid and turn the Lock/Unlock handle to "NON PRESSURE" or "HIGH PRESSURE" while cooking.

- You can select cooking with high pressure when you turn the handle to "HIGH PRESSURE". This is the function of safety device which indicates that the cooker is properly locked, and cooking with high pressure is available.
- If you turn the handle to "NON PRESSURE" you can choose to cook without pressure or select cooking. Then "NON PRESSURE" signal is displayed on the Display.
- If "HIGH PRESSURE" or "NON PRESSURE" does not appear on the Display, Preset/Auto Clean button does not work.

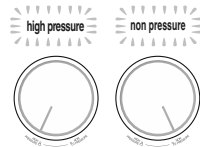

2. When cooking with high pressure is done, turn the Lock/Unlock handle from "HIGH PRESSURE" to "NON PRESSURE," and then open up the lid with "Unlock" button.

- If steam is not completely exhausted after cooking, the handle might not be easily turned from "HIGH PRESSURE" to "NON PRESSURE." In such a case, allow remaining steam to escape by tilting the Pressure weight.

3. Make sure that the Lock/Unlock handle is completely turned to "NON PRESSURE" when opening and closing the lid.

## How to Use the Handle

Do not try to close the LID by force. It can damage your cooker and cause problems.



1. Check to make sure the inner pot is placed correctly inside the main body.
2. To close the lid, turn the handle to unlock as shown in the picture on the left.



3. If there is excess steam inside the inner pot it might be difficult to lock the handle. Twist the pressure weight and allow the excess steam to release. Then try to turn the handle again.

# FUNCTION OPERATING PART / ERROR CODE AND POSSIBLE CAUSE

## Keep Warm/ Reheat button

Use for warming or reheating the cooked rice before eating.

## Preset/Auto Clean button

Use it to preset the cooking time you want. When you use automatic steam cleaning function.

## Time/ Setting button

Used to set GABA Rice, High Pressure Steam, Porridge, Non Pressure Steam cooking time. Used to modify the Preset time. Used to set voice volume and voice setting. Used to set keep warm temperature, customize individual keep warm preference, customize individual cooking preference.

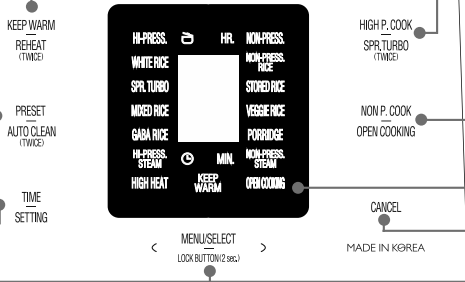

## Menu/ Select button

Used to select White rice, High heat White rice, Super Turbo White Rice, Mixed Rice, High Heat Mixed Rice, GABA Rice, High Heat GABA Rice, High Pressure Steam, Non Pressure White Rice, Frozen Stored Rice, Veggie Rice, Porridge, Non Pressure Steam. Used to Change the function selected by the Time/Setting button.

## HIGH Pressure Cook/ Super Turbo button

Used to start high-pressure cooking and high-pressure cooking

## NON Pressure Cook/ Open Cooking button

Used to start non-pressure cooking and non-pressure cooking

## Display

## Cancel button

This function is used to cancel a selection or release remaining steam in the inner pot. (Keep pressing the Cancel button for 2 seconds for safety reason if you want to cancel while cooking.)

- \* If no operation is done while power cord is plugged, the system will be on standby mode as shown in the figure. (The menu on standby screen, time, voice and customized rice taste stage may differ depending on user configuration.)
- \* If cancel button is pressed during cook, the rice cooker will go on standby mode.
- \* Press the button until the buzzer sounds. Picture may vary depending on model.
- \* It switches to power save mode after 1 minute from standby (Lid handle light is off)
- ▶ How to cancel power save mode : Power save mode is canceled by pressing the button, turning the lid coupling handle, or opening or closing the lid.

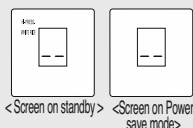

## Error Code and Possible Cause

When the product has any problems or used it inappropriately, you can follow the below marks. If error persistently shows up even in normal using conditions or after taking measure, inquire with customer service.

	When the inner pot is not placed into the unit.		This error code is displayed when the smart locking system has failed. Please contact Service center for service inquiry.
	This error code is displayed when the smart locking system has failed. Please do not open the lid until cooking is completely finished. If error occurs during warming or stand by mode, please open the lid after turn off the power. Please contact Service center for service inquiry.		Problem on temperature sensor. ("E.." mark, "E-P" mark, "E-k" mark blink.) Inquire with customer service.
			When pressing the 'High Pressure Cook/Super Turbo' and 'Keep Warm/Reheat' and 'Preset/Auto Clean' and 'Menu/Select' button, while the lid handle is on incorrect pressure mode. Turn the lid handle "High Pressure" or "Non Pressure".
	When boiling only water and When the product fails. Please contact Customer Service center.		Problem on micom memory. Please contact Customer Service center.
	It is appears on the display when you press 'High Pressure Cook' or 'Preset/Auto Clean' button again, or if the high pressure cooking has finished and you've never ever turned the handle to "Non Pressure". It can be solved by turning handle to "Non Pressure" and then turn to "High Pressure". If the problem persists, contact the customer service center.		Problem on environment sensor. Please contact Customer Service center.
	Problem on environment sensor. Please contact Customer Service center.		Problem on micom memory. Please contact Customer Service center.

# HOW TO SELECT HIGH PRESSURE MODE OR NON PRESSURE MODE

## Select high pressure mode

Turn the Lock/Unlock Handle to “High pressure .

- ▶ When the Lock/Unlock handle turns into orange color, and “High Pressure” is displayed on the Display, high pressure mode is turned on.
- ▶ You can only select high pressure menu in high pressure mode.
- ▶ High Pressure menu: White Rice, High Heat White Rice, Super Turbo White Rice, Mixed Rice, High Heat Mixed Rice, GABA Rice, High Heat GABA Rice, High Pressure Steam

### 1 Please turn Lock/Unlock handle from “Non pressure” to “High pressure” if you want to change from non pressure mode to high pressure mode.

- ▶ If it is changed to high pressure mode, only high pressure mode flickers for 3 seconds, and then the saved high pressure menu is turned on.
- ▶ Voice, saying “This is High Pressure mode. Select High Pressure menu.” comes out.
- ▶ Light of the Lock/Unlock handle is changed into orange color.

< Screen on standby (Non pressure mode) >

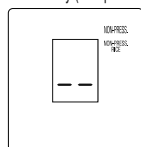

When changing into high pressure mode

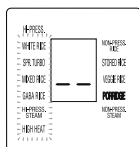

Flickering for 3 seconds

< Screen on standby (High pressure mode) >

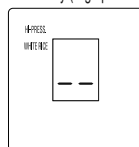

## Select non pressure mode

Turn the Lock/Unlock Handle to “ Non Pressure”.

- ▶ When the Lock/Unlock handle turns into White color, and “Non Pressure” is displayed on the Display, non pressure mode is turned on.
- ▶ You can only select non pressure menu in non pressure mode.
- ▶ Non Pressure menu: Non Pressure White Rice, Frozen Stored Rice, Veggie Rice, Porridge, Non Pressure Steam.

### 1 Please turn Lock/Unlock handle from “High pressure” to “Non pressure” if you want to change from high pressure mode to non pressure mode.

- ▶ If it is changed to non pressure mode, only non pressure mode flickers for 3 seconds, and then the saved non pressure menu is turned on.
- ▶ Voice, saying “This is non Pressure mode. Select non Pressure menu.” comes out.
- ▶ Light of the Lock/Unlock handle is changed into White color.

< Screen on standby (High pressure mode) >

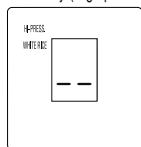

When changing into Non pressure mode

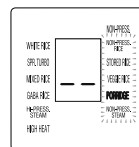

Flickering for 3 seconds

< Screen on standby (Non pressure mode) >

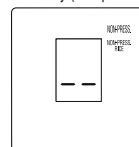

### 2 Make sure to close the lid and turn the Lock/Unlock handle to “high pressure” or “non pressure” while cooking. You cannot select menu if the pressure mode is not correctly selected.

- ▶ At the time of button input, the voice “Turn the handle to the desired pressure position.” is output.
- ▶ When the Menu / Select button is input, a voice comes out saying “Turn the Cover Handle to High Pressure mode or Non Pressure mode, and select the menu.”
- ▶ Please turn the handle in a correct way, and select high pressure mode or non pressure mode.

< Mid position of the Lock/Unlock handle >

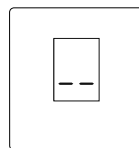

#### ⚠ Cautions

When cooking in non pressure mode, please cook the designated capacity of food.

When cooking, please do not exceed the designated capacity of food.

- If you exceed the capacity designated in the cooking guide, the Pressure Weight and Cleaning Soft Steam Cap lead to the overflow of food.
- Please follow the designated cooking guide.

# HOW TO SET OR CANCEL VOICE GUIDE FUNCTION

## Voice Setting

You may select your preferred voice among, 'Korean, English and Chinese.'

▶ The default is English.

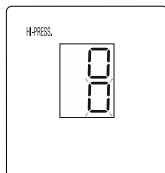

Example) When set to Korean voice

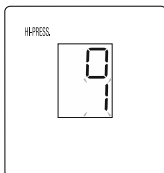

Example) When set to Chinese voice

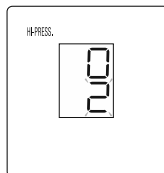

Example) When set to English voice

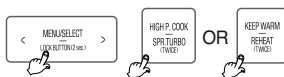

1. Press 'Time/Setting' button once. 'Time/Setting' button needs to be pressed for over 2 second at the first time. (If you press 'CANCEL' or do not operate for 7 seconds, setting will be cancelled and you will go back to the standby mode.)
2. After setting voice with 'Menu / Select' button, Korean, English or Chinese, and press 'HIGH Pressure Cook' or 'Keep Warm' button.

## Voice guide volume control (The function which can control volume and cancel)

'Time/Setting' button needs to be pressed for over 2 second at the first time.

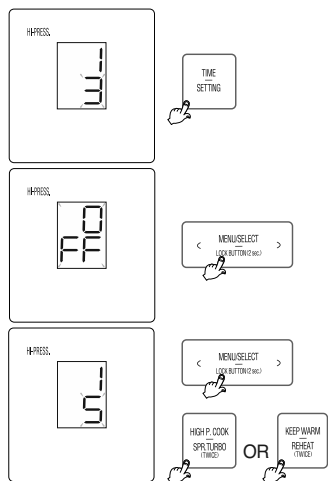

'3' sign is displayed when entered volume control mode by pressing 'Time/Setting' button 2 times.

If set value became 'OFF' by pressing Menu / Select button, voice guide function is off.

Press button to set '5', that is the maximum volume sound.

▶ After setting desired volume, press 'HIGH Pressure Cook' or 'Keep Warm' button to store.

## What is Power Outage Function

- ▶ This product memorizes the current condition before the power outage even if there is a power outage, so if the power comes back on within about 2 minutes after the power outage, it will operate normally. (There may be a slight difference depending on the product.)
- ▶ If cooking rice or cooking is canceled due to the power outage, you must press the 'High Pressure Cook' or 'Non Pressure Cook' button again to cooking rice or cook.
- ▶ If there is a power outage while cooking rice or cooking, the cooking rice or cooking time will be delayed as much as the power outage time, and the cooking rice or cooking status may be slightly different depending on the power outage time.

# BEFORE COOKING RICE

- 1 Clean the inner pot and remove any moisture.
  - ▶ Clean the inner pot with a dishcloth.
  - ▶ Using a rough sponge may cause damage to the inner pot.
- 2 Measure the rice with a measuring cup.
  - ▶ A full cup of rice of measuring cup is equal to one person serving.
  - (Example : 3 persons for 3 cups, 6 persons for 6 cups)
- 3 Wash the rice with another container until the water becomes clear. (We recommend not to use inner pot for washing grains)
- 4 Put rinsed rice into the inner pot.

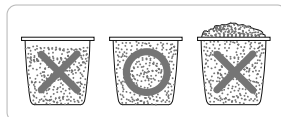

- 5 According to menu, adjust the water amount.
  - ▶ For measuring, place the inner pot on a leveled surface and adjust the amount of water.
  - ▶ The marked line of the inner pot indicates water level when putting the rice and water into inner pot together.
  - ▶ About water scale
    - White Rice, High heat White Rice, Frozen Stored Rice : Adjust water level to the water scale for 'WHITE RICE'. White Rice and High heat White Rice can be cooked to max 10 servings. Frozen Stored Rice to max 6 servings.
    - Super Turbo White Rice : Adjust water level to the water scale for 'SPR. TURBO'. Super Turbo White Rice can be cooked to max 4 servings.
    - Mixed Rice, High heat Mixed Rice : Adjust water level to the water scale for 'MIXED RICE'. Mixed Rice and High heat Mixed Rice can be cooked to max 8 servings.
    - Non Pressure White Rice, Veggie Rice : Adjust water level to the water scale for 'NON P RICE'. Non Pressure White Rice, Veggie Rice can be cooked to max 6 servings.
    - GABA Rice, High heat GABA Rice : Adjust water level to the water scale for 'GABA RICE'. GABA Rice and High heat GABA Rice can be cooked to max 6 servings.
    - Porridge(Thick): Adjust water level to the water scale for 'PORRIDGE'. Porridge(Thick) can be cooked to max 2 servings.
    - Porridge(Thin): Adjust water level to the water scale for 'THIN PORRIDGE'. Porridge(Thin) can be cooked to max 1 servings.

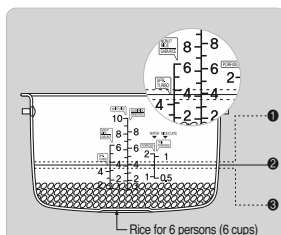

- 1 To cook sticky rice or old rice: Pour more water than the required water level
- 2 White Rice for 6 persons (6 cups) : Set the water to scale 6 of "White Rice"
- 3 The rice is fully soaked or to over cooked rice: Pour less water than the measured scale.
- 4 When rice is half-cooked or firm: It happens because of the kind of the rice or the degree of dryness. In this case, please add 1-10% of the water.

\* Please, Cook hard grains such as beans and red beans by soaking or boiling them in the mixed rice menu.  
 \* Please, refer to the cooking menu time for the each menu.(Refer to page 24)  
 \* This model does not support Susuhi rice menu.

- 6 Please plug the power cord before inserting inner pot in the rice cooker. Put the inner pot correctly.
  - ▶ If there is any external substance on the temperature sensor or the bottom of the inner pot, wipe it off before putting the pot into the main unit.
  - ▶ Lid will not close if the inner pot is not placed correctly in the main body (Place the inner pot to the corresponding parts of the main body)

- 7 Close the lid and turn the lock/unlock handle to the "High pressure 𠄎" or "Non pressure" position.
  - ▶ When the Lock/Unlock handle turns into orange color, and "High Pressure" is displayed on the Display, high pressure mode is turned on. When the Lock/Unlock handle turns into White color, and "Non Pressure" is displayed on the Display, no pressure mode is turned on.
  - ▶ When you press 'Non Pressure Cook' button in high pressure mode and when you press 'High Pressure Cook' button in no pressure mode, the warning sound rings and "E01" signal is displayed, and cooking is not available.
  - ▶ Cooking is available only when you press 'High Pressure Cook' button in high pressure mode and when you press 'Non Pressure Cook' button in no pressure mode.

\* During warming, please cancel warming by pressing 'cancel' button, and then select the function.

  - ▶ If "E 01" appears on the display, please turn the Lock/Unlock handle to "Non pressure," and turn the button again to "high pressure 𠄎." Then the machine will work properly. (Function to check whether the lid is completely and properly being closed.
  - \* If you turned the Lock/Unlock handle to "Non pressure" for more than one time after cooking, that is not the case.

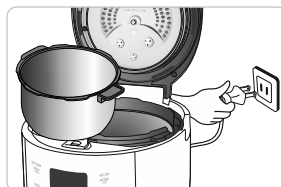

# HOW TO COOK

## 1 Turn the handle to the desired pressure position.

- Please mount detachable cover.
- Please keep "Pressure weight" horizontal.
- You cannot select menu if the pressure mode is not correctly selected.
- If the Lock/Unlock handle is on high pressure mode, only high pressure menu is selected, and if it is on non pressure mode, only non pressure menu is selected.

### <High Pressure mode>

- Each time Select button is pressed, the selection switches in the sequential order, White Rice → High Heat White Rice → Super Turbo White Rice → Mixed Rice → High Heat Mixed Rice → GABA Rice → High Heat GABA Rice → High Pressure Steam.

### <Non Pressure mode>

- Each time Select button is pressed, the selection switches in the sequential order, Non Pressure White Rice → Frozen Stored Rice → Veggie Rice → Porridge → Non Pressure Steam.
- If the button is pressed, repeatedly, the menu switches continuously in sequential order.
- In the cases of White Rice, High Heat White Rice, Mixed Rice, High Heat Mixed Rice, GABA Rice, High Heat GABA Rice and Non Pressure White Rice the menu remains memorized once each cooking is completed, so for continuous use of the same menu, no selection of menu is required.

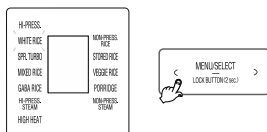

ex) In case of selecting White Rice.  
 ▶ You can hear a voice, White Rice.

## 2 Start cooking by pressing 'High Pressure Cook/Super Turbo' or 'Non Pressure Cook' button.

- Before cooking, if you want to select high pressure menu, please turn the Lock/Unlock handle to "High pressure" and press "High Pressure Cook/Super Turbo" button. If you want to select non pressure menu, please turn the Lock/Unlock handle to "Non pressure" and press "Non Pressure Cook" button.
- If you select high pressure menu and press "Non Pressure Cook" button, warning sound rings, E01 signal appears on the display, and voice, saying "This is High pressure menu. Press "High Pressure Cook" button," comes out. If you select Non pressure menu and press "High Pressure Cook/Super Turbo" button, warning sound rings, E01 signal appears on the display, and voice, saying "This is Non pressure menu. Press "Non Pressure Cook" button," comes out.
- Then press the "High Pressure Cook/Super Turbo" button, and sound "White Rice. Cuckoo start cooking"
- If you did not turn the Lock/Unlock handle to "High pressure" or "Non pressure" and if you pressed "High pressure cook/Super Turbo" button or "Non Pressure Cook" button, warning sound rings and E01 signal appears on the display, and then voice, saying "Turn the handle to the desire pressure position" comes out and the machine does not work.
- Time for cooking may vary according to cooking capacity, temperature of water and cooking conditions.

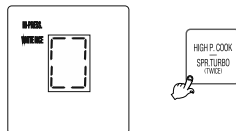

ex) When cooking White Rice in high pressure mode.

## 3 Steaming (ex: White Rice)

- The cooktime remaining on the display is shown from cooking thoroughly. The cook time is different according to the menu.
- Be careful not to burn yourself from the automatic steam outlet.

ex) In case of 14minutes left.



## 4 The end of cooking

- When cooking is completed, warming will start with the voice "White Rice has been completed."
- If you want to stop warming, Push 'Cancel' button.
- When cooking ends, stir rice equally and immediately. If you don't stir rice at once and keep it stagnant, rice will go bad and smell bad.
- If the lid handle is not working well, take out the steam completely out of inner pot by turning over pressure weight.
- While cooking, do not press cancel button.



### Cooking time for each menu

Menu Class	White Rice (main menu)	High Heat White Rice	Super Turbo White Rice	Mixed Rice	High Heat Mixed Rice	GABA Rice	High Heat GABA Rice	Non Pressure White Rice	Veggie Rice	Frozen Stored Rice	Porridge (Thick)	Porridge (Thin)	Non Pressure Steam	High Pressure Steam	Auto Clean
Serving	1~10	1~10	1~4	1~8	1~8	1~6	1~6	1~6	1~6	1~6	1cup~2cup	0.5cup~1cup	See detailed guide to cooking by the menus.		Pour water up to the line 2 for WHITE RICE. About 24min
Cooking time	24~39min	25~42min	15~21min	46~59min	47~62min	53~68min	55~71min	41~51min	43~53min	23~32min	45~60min	50~60min			

- \* After cooking multi cook etc, the smell may permeate into the unit, use the Unit after cleaning the rubber packing and lid part.
- \* Cooking time by menus may vary to some degree depending on the using environment of the product.



## How to use the cooking menu

<b>White rice</b>	When you want to have sticky and nutritious white rice.	<b>Mixed Rice</b>	This menu is used to cook a variation of brown rice. mixed rice.
<b>GABA Rice</b>	Used to cook germinated of brown rice.	<b>Frozen Stored Rice</b>	This menu is used to keep rice frozen.
<b>Porridge</b>	Used to cook Porridge by setting a time manually.	<b>Veggie Rice</b>	Used this function to cook rice mixed with vegetables.
<b>High pressure Steam, Non pressure Steam</b>	Manually set cooking time and cook with high pressure(1.8kgf/cm <sup>2</sup> ) and non pressure(1kgf/cm <sup>2</sup> ).	<b>Non Pressure White Rice</b>	Use when you want to eat soft rice.
<b>Auto Clean (Steam Cleaning)</b>	This menu is used to eliminate small soaked after cooking or warming.	<b>High Heat (White rice, Mixed Rice, GABA Rice)</b>	Use when cooking more sticky and soothing Cooked Rice. (Melanozing effect could be increased.)
<b>Super Turbo White Rice</b>	<ul style="list-style-type: none"> <li>• When cooking Super Turbo White Rice, the cooking time is reduced compared to white rice menu.</li> <li>• How to cook Super Turbo White Rice 1: Press HIGH Pressure Cook/Super Turbo button twice.</li> <li>• How to cook Super Turbo White Rice 2: After selecting the Super Turbo White Rice menu, Press the HIGH Pressure Cook/Super Turbo button. (It takes about 15 minutes for one serving of Super White Rice)</li> <li>• The mode of Super Turbo White Rice does not produce cooked rice as good as normal cooking mode. Use Super Turbo White Rice mode only for 4 servings or less.</li> <li>• For better taste of cooked rice, cook rice in White Rice Super Turbo mode after macerating rice for 20 minutes or so before cooking.</li> </ul>		

\* After cooking in White Rice Super Turbo mode or cooking of small serving, discard water.

## How to use AUTO CLEAN (Steam Cleaning)

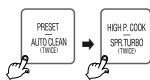
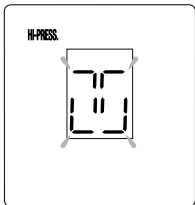

ex) Auto clean in high pressure mode

Pour water according to the water scales for Auto Clean mode, close the lid and turn the Lock/Unlock handle to "High pressure 凸" or "Non pressure."

After selecting Auto Clean button by pressing the 'Preset/Auto Clean' button for two times, press 'High Pressure Cook/Super Turbo' buttons in high pressure mode, and press 'Non pressure cook' button in no pressure mode.  
\* If you regularly do the automated cleaning, you can maintain the cleanliness of valve.

## Melanozing phenomenon

The cooked rice can be light yellow at the bottom of the oven, because this product is designed to improve pleasant flavor and taste. Especially, melanozing is more serious at the "Preset cooking" than just "Cooking". It does not mean malfunction.

\* When mixing other rice with White rice, Melanozing effect could increase more than "White rice cook" setting.

# HOW TO USE “CUSTOMIZED COOKING FUNCTION”

## CUCKOO “Customized Taste Function”

This function allows you to select your preferred temperature level when cooking. Compare to previous model, the temperature level has been fixed, and consumers are able to set the temperature with their preferences. The initial value is set to 4/3. Please select the level depending on your preferences.

- High level : Select high level if you are cooking grains or want sticky rice.
- Low level : Select low level if you are cooking freshly harvested rice or don't want sticky rice.

## How to use CUCKOO “Customized Taste Function”

Press the “TIME/SETTING” button at standby mode for 2 seconds to go to voice setting mode. Press “TIME/SETTING” button 4 times to enter the customized taste setting mode. All options supported by ‘CUCKOO Customizes Taste’ will be displayed.

### ① CUCKOO customized taste setting display

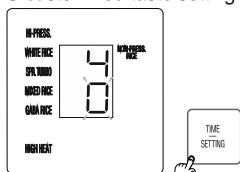

Press the “TIME/SETTING” button for 2 seconds to enter Voice Setting mode. Press “TIME/SETTING” button 4 more times to go to customized taste setting display. Please refer to the display for the initial values.

### ② High level adjusting mode

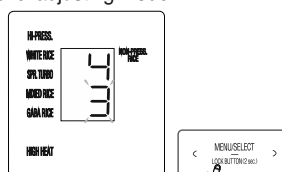

Press the “MENU/SELECT” button to change display as shown in the image above.

### ③ Low level adjusting mode

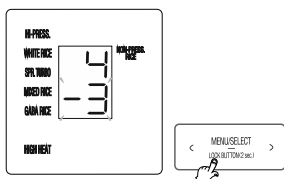

Press the “MENU/SELECT” button to change display as shown in the image above.

### ④ Setting complete display

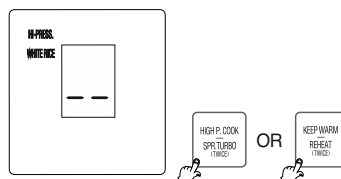

Press “HIGH Pressure Cook/Super Turbo” or “Keep Warm/Reheat” button to save the set value and return to standby mode. (If you press ‘CANCEL’ or do not operate for 7 seconds, setting will be cancelled and you will go back to the standby mode.) (When you press the “TIME/SETTING” button, setting will be cancelled and you will go back to the standby mode.)

1. “CUCKOO Customized Taste” function is applied to the following options:

White rice, High Heat White rice, Mixed Rice, High Heat Mixed Rice, GABA Rice, High Heat GABA Rice, Super Turbo White Rice, Non Pressure White Rice

2. Set up the step of customized cooking function to taste. The scorch can occur when cooking in high level mode.

3. After setting each stage, cooking status may vary according to rice status in cooking status and water content percentage.

# HOW TO USE “GABA RICE (BROWN RICE)”

## What is Germinated Brown rice?

- ▶ Brown rice has richer nutrients than polished rice. However, brown rice is rather tough and harder to be digested. By germination, the enzymes in the brown rice are activated, generating nutrients and become more digestible.

## Tips to Buy Quality Brown Rice?

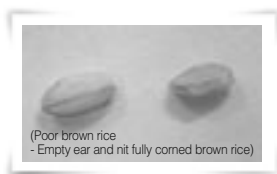
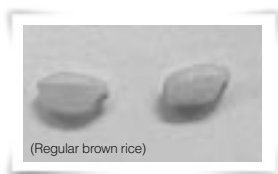

- 1 Check the dates of harvest and pounding.
  - ▶ The dates should be within 1 year from harvest, 3 months from pounding.
- 2 Inspect rice with your eyes.
  - Check that embryo is alive
  - Rice surface should be light yellow and glazing. Whitely stirred up surface, or darkish colored Brown rice is not suitable for germination
  - Avoid fractured, not fully corned, or empty ear's. Empty ear's may generate odors during germination and bluish-nor corned Brown rice cannot be germinated.

## Features of Germinated Brown rice

Germinated Brown rice increases nutrients and enhances taste which is a weak point of brown rice. Germinated Brown rice also improves digestion.

- ▶ Taste will be greatly enhanced.
- ▶ Digestive and rich in nutrients.
  - Diabetic hormone is generated improving digestion.
- ▶ Good as a health food for children or students.
  - Rich with dietary fiber.
- ▶ Germinated brown rice has rich GABA Rice (Gamma Amino Butyric Acid)
  - GABA promotes metabolism in liver and kidneys, suppresses neutral fat, lowers blood pressure, promotes metabolism in brain cells - these effects have been proven by medical science.

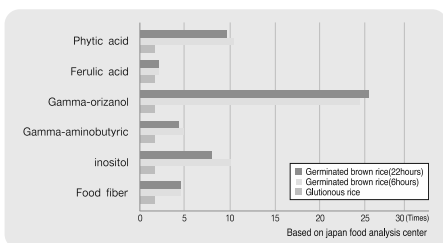

### < Comparison of Germinated brown rice' s nutrition and Glutinous rice' s (6 hours) nutrition. >

- ▶ Phytic acid 10.3Times
- ▶ Ferulic acid 1.4Times
- ▶ Gamma-orizanol 23.9Times
- ▶ Gammma-aminobutyric 5Times
- ▶ Inositol 10Times
- ▶ Food fiber 4.3Times

# HOW TO USE “GABA RICE (BROWN RICE)”

## Using ‘Brown GABA’ Menu

- 1 In order to promote germination, soak brown rice for 16 hours in water.  
Method of Pre-germination
  - ▶ Put washed brown rice in an appropriate container, pour sufficient water to soak the rice.
  - ▶ Pre-germination shall not exceed 16 hours. Make sure to wash rice clean with flowing water before using ‘Brown GABA’ menu. Be careful that hard washing may take off embryos which generate the germination.
  - ▶ Unique smell may be generated according to the soaking time of pre-germination.
  - ▶ When pre-germination has been completed, wash the rice and put it into inner pot. Pour appropriate amount of water and use ‘GABA Rice’ menu.
  - ▶ In summer or hot temperature environment, odor may be generated. Reduce germination time and wash clean when cooking.

- 2 **Set the Locked/Open handle at ‘High pressure’, press “MENU/SELECT” button to select ‘Brown GABA’.**

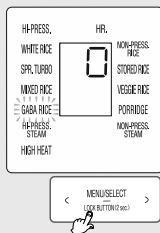

\* First setting time 0H(0 Hours)

- ▶ When the “GABA Rice” is selected, “0H” is indicated in the display.

- 3 **Press “TIME” button**
- 
1. Pressing “TIME” button changes Germination time.

2. ‘Brown GABA’ time can be set up by 0, 3 hours.

☞ If GABA time is set at ‘0’ hour, press “HIGH Pressure Cook/Super Turbo” button and it will start cooking immediately. To cook without germination or cooking germinated Brown Rice, set at ‘0’ hour.

- 4 **Press “HIGH Pressure Cook/Super Turbo” button**

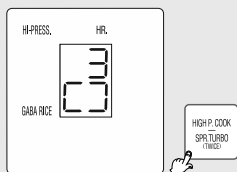

- ▶ Press “HIGH Pressure Cook/Super Turbo” button to start the ‘Brown GABA’ process. Cooking will begin immediately.
- ▶ During ‘Brown GABA’ mode, “” indicator will show the remaining time and will be displayed in minutes with the “3H” mark going around clockwise.

## Precautions for ‘Brown GABA’ Cooking

- 1 If smaller germ is preferred, omit pre-germination process. Select ‘Brown GABA’ menu, set-up appropriate germination time, and start cooking (nutrient ingredients do not vary significantly by the size of germ).
- 2 During hot seasons, longer germination time may generate odor. Reduce germination time.
- 3 GABA Rice cooking is allowed up to 6 persons.
- 4 Tap water can be used for germination. However, spring water is recommended. Germination may not be properly performed in hot or boiled water even after cooling.
- 5 Germination rate, germ growth may differ by the Brown rice type, condition or period of storing, etc.
  - Germinated brown rice is sprouted brown rice. Germination rate and growth may differ by the Brown rice type. The brown rice should be within 1 year from harvest, and not long since powdered.
- 6 In GABA mode, preset on 3H may not be possible.
- 7 The taste of rice could be different as depending on a kind of brown rice. Use customized taste function or control the amount of water for your taste.
- 8 Depending on the state of the surrounding environment or the condition/type of rice, the sprouts of rice may not be visible or appeared.

# HOW TO COOK HIGH PRESSURE STEAM

## HOW TO USE HIGH PRESSURE STEAM MENU AND RESERVATION

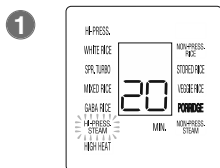

The cover handle toward “HIGH PRESSURE ”, and press the Menu/Select button to select HIGH PRESSURE STEAM

▶ When the High-Pressure Steaming menu is selected, the time is displayed on the Display.



**2** Set the cooking time with the TIME/SETTING button.  
[Please, refer to the detailed cooking times for the each menu.(Refer to page 46~53)]

1.



Press the TIME/SETTING button, and the time for high-pressure steaming will be increased by five minutes.

▶ If you keep pressing it, the time turns into Nonstop.

2. The time for HIGH PRESSURE steaming is adjustable from 10 to 90 minutes.

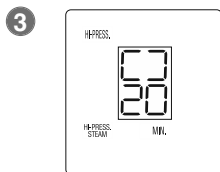

Press the High Pressure Cook/Super Turbo button.

▶ Press the High Pressure Cook/Super Turbo button to start high pressure steaming.  
When the high pressure steam cooking starts, the remaining time is displayed.

**4** How to Reserve High-Pressure Steaming

1. Turn the Cover Handle toward “HIGH PRESSURE ”, and press the MENU/SELECT button to select HIGH PRESSURE STEAM.



2. Set the cooking time with the TIME/SETTING button



3. Press the PRESET/AUTO CLEAN button.



4. Press the Time/Setting button, adjust the preset time, and press the High Pressure Cook/Super Turbo button.



# HOW TO OPEN COOK

## What is open cooking?

Open cooking is a function that allows the user to release the smart locking device, during a non pressure cooking process, and add ingredients or stir the contents in the pot.

## How to use open cooking function.

- 1 During a non pressure menu cooking, select the Setting/Open Cooking button.

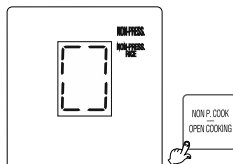

< Button Indication >

- 2 Wait until the smart locking device is released.  
▶ It takes 5 to 60 seconds for the smart locking device to be released.

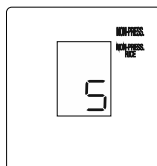

< Remaining Time under released locking device >

- 3 Once the display on the right appears, open the lid and add ingredients or stir the contents.  
▶ An audible instruction of "Please open the lid" is provided.  
▶ Please, refer to the detailed cooking for the each menu. (Refer to page 41~54)  
▶ Do not press the Open Lid button when the smart locking device remaining time is displayed or during cooking.  
Only press the Open Lid button when the Add Ingredients Indicator is activated.

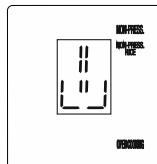

< Add ingredient indication >

- 4 After opening the lid, close the lid within 3 minutes.  
▶ Cooking will be canceled if the lid is kept open for more than 3 minutes.

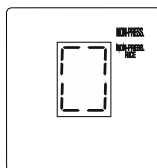

< Cooking process indication >

### ⚠ CAUTION

#### Cautions for open cooking

- Do not exceed the designated capacity.
- If the designated capacity is exceeded, the appliance may overflow due to boiling.
- While the lid is open, the inner pot will not be heated.
- Burn Hazard! Do not remove the detachable cover.
- Close the lid only when the inner pot and detachable cover are properly assembled.
- Pressing lid clamp knob when the smart locking device is activated may cause damage to the appliance. Only press the Open Lid button when the Add Ingredients Indicator is activated.
- Contact Cuckoo Customer Service center when the appliance does not properly work.
- When the lid does not open after open cooking or non pressure cooking is completed. Press the cover as shown on the right to unlock the smart locking device, and then push the clamp knob to open.
- When "EL1" error code occurs, please contact with Customer Service for service inquiry.
- When "EL2" error code occurs, please do not open the lid until cooking is completely finished.
- If error occurs during warming or stand by mode, please open the lid after turn off the power. Please contact Service center for service inquiry.



# HOW TO COOK NON PRESSURE STEAM

## HOW TO USE NON PRESSURE STEAM MENU AND RESERVATION

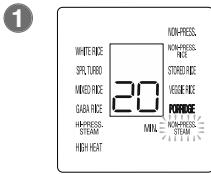

The cover handle toward “NON PRESSURE”, and press the Menu/Select button to select NON PRESSURE STEAM.

► When the Non-Pressure Steaming menu is selected, the time is displayed on the Display.



### 2 Set the cooking time with the TIME/SETTING button.

1.



Press the TIME/SETTING button, and the time for Non-pressure steaming will be increased by five minutes.

► If you keep pressing it, the time turns into Nonstop.

2. The time for NON PRESSURE steaming is adjustable from 10 to 90 minutes.

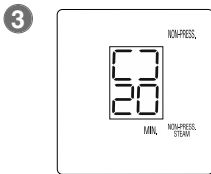

Press the Non Pressure Cook button.

► Press the Non Pressure Cook button to start Non pressure steaming. When the Non-Pressure steaming begins, the remaining time is displayed



### 4 How to Reserve Non-Pressure Steaming

1. Turn the Cover Handle toward “NON PRESSURE”, and press the MENU/SELECT button to select NON PRESSURE STEAM.



2. Set the cooking time with the TIME/SETTING button



3. Press the PRESET/AUTO CLEAN button.



4. Press the Time/Setting button, adjust the preset time, and press the Non Pressure Cook/Open Cooking button.



#### ⚠ Precautions

- Precautions when using NON PRESSURE STEAM.
- Do not cook over the specified capacity.
  - If the specified capacity is exceeded, it will overflow.

# HOW TO COOK PORRIDGE

## HOW TO USE PORRIDGE MENU AND RESERVATION

1

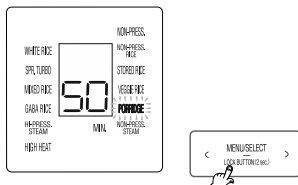

The cover handle toward “NON PRESSURE”, and press the SELECTION button to select NON PRESSURE STEAM.

► When the porridge menu is selected, the time is displayed on the Display.

2

Set the cooking time with the TIME/SETTING button.



Press the TIME/SETTING button, and the time for Porridge will be increased by five minutes.

► If you keep pressing it, the time turns into Nonstop.

2. The time for Porridge is adjustable from 20 to 90 minutes.

3

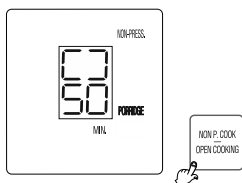

Press the NON Pressure Cook button.

► Press the NON Pressure Cook button, and the steam begins. When the porridge begins, the remaining time is displayed

4

How to Reserve Porridge

1. Turn the Cover Handle toward “NON PRESSURE”, and press the MENU/SELECT button to select NON PRESSURE STEAM.



2. Set the cooking time with the TIME/SETTING button



3. Press the PRESET/AUTO CLEAN button.



4. Press the SELECTION button, adjust the preset time, and press the NON PRESS. button.



### ⚠ Precautions

Precautions when using PORRIDGE.

- Do not cook over the specified capacity.
- If the specified capacity is exceeded, it will overflow.



# HOW TO COOK FROZEN STORED RICE

## What is Frozen Stored Rice?

This function is used to make rice that will taste freshly cooked after being frozen and thawed.

## How to use Frozen Stored Rice menu

**1** Turn the lid handle to the “ Non Pressure” position and Press Menu/Select button to select the Frozen Stored Rice

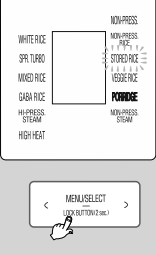

WHITE RICE  
SPA TURBO  
MIXED RICE  
GARU RICE  
H/PRESS STEAM  
HIGH HEAT

NON-PRESS  
NON-PRESS 1 P  
NON-PRESS 2 P  
STORAGE RICE  
YEBBERICE  
PORRIDGE  
NON-PRESS STEAM

< MENU/SELECT (ON/RTN) (MEMO) >

**2** Press Non pressure Cook/Open cooking button to start cooking.

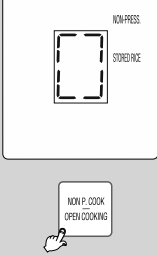

NON-PRESS  
STORAGE RICE

NON P. COOK  
OPEN COOKING

**3** When cooking is complete, open the lid and stir the cooked rice thoroughly. Next, move the cooked rice into a microwavable container and place it in a freezer to preserve.

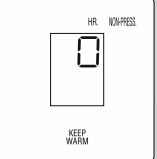

HR NON-PRESS

KEEP WARM

## Precautions when cooking frozen stored rice

- 1** When using the Frozen Stored Rice menu, refer to the water level used when cooking white rice. The maximum cooking capacity for Frozen Stored Rice is 6 servings.
- 2** When the rice has been completely cooked, open the lid and stir the rice thoroughly.
- 3** Move the cooked rice into microwavable containers in single serving portions (210g), and place them into the freezer for preservation.
- 4** When microwaving your Frozen Stored Rice, open the lid of the microwavable container slightly and heat for 3 min 30 sec (per serving). (Heating time may differ due to amount of rice, size of container, microwave output, etc.)
- 5** Please note that the quality of your rice may be affected as the storage period increases.



### Precautions

Precautions when using the Frozen Stored Rice:

- Do not cook beyond the recommended amount.
- Cooking beyond the recommended may result in overflowing.
- Do not remove the detachable cover as it may cause burns.

# HOW TO USE PRESET FUNCTION

## How to preset timer for cooking (How to use high pressure menu)

### 1 Turn the Lock/Unlock handle to “high pressure” and press Preset/Auto Clean button when orange light is on.

- ▶ If you press Preset/Auto Clean button without turning the Lock/Unlock handle to “high pressure,” preset is not available.
- ▶ If you press Preset/Auto Clean button, voice, saying “Set preset time with Time button, then press High pressure cook button,” comes out, the setting time is displayed on the Display, and the preset icon blinks.
- ▶ To set the preset time during the warming mode, stop the warming mode by pressing the Cancel button prior to setting the preset time.

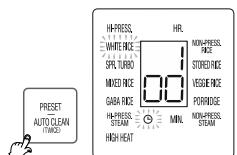

< Preset mode display >

### 2 Press the Time button to set the preset time.

- ▶ Each time you press the Time/Setting button, 10 minutes are added to the preset time.
- ▶ If you keep pressing the button, the time will change continuously.
- ▶ Preset time ranges from 1 hour to 12 hours and 50 minutes

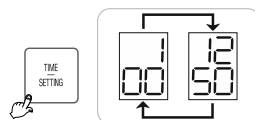

### 3 Press the Menu/Select button to select the menu.

- ▶ GABA rice option cannot be preset with 3H setting.
- ▶ If you want to preset, select the 0H option.
- ▶ High pressure cook option can be preset after setting the time for the option.
- ▶ When the set time is longer than 60 minutes, the preset time will be set as 2 hours.
- ▶ If you do not set a specific option, the default will preset as White rice.

### 4 Press the HIGH Pressure Cook/Super Turbo button.

- ▶ A voice comes up saying “White Rice has been reserved.”
- ▶ When the preset mode begins, the preset light will stop blinking and the preset time will go down by minute until it starts the preset cooking.

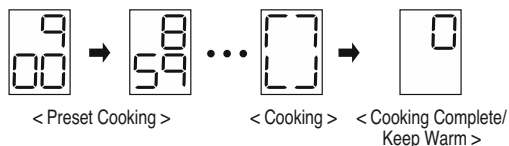

- ▶ The preset time displayed on the screen is the remaining time until completed cooking. (The completion time may vary depending on either the use condition or the cooking capacity)

# HOW TO USE PRESET FUNCTION

## How to preset timer for cooking (How to use non pressure menu)

### 1 Turn the Lock/Unlock handle to “ non pressure” and press Preset/Auto Clean button when white light is on.

- ▶ If you press Preset/Auto Clean button, voice, saying “Set preset time with Time button, then press non pressure cook button,” comes out, the setting time is displayed on the Display, and the preset icon blinks.
- ▶ To set the preset time during the warming mode, stop the warming mode by pressing the Cancel button prior to setting the preset time.

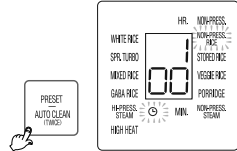

< Preset mode display >

### 2 Press the Time button to set the preset time.

- ▶ Each time you press the Time/Setting button, 10 minutes are added to the preset time. If you keep pressing the button, the time changes continuously.
- ▶ Preset time ranges from 1 hour to 12 hours and 50minutes

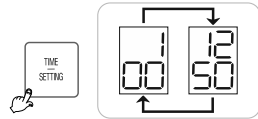

### 3 Press the Menu/Select button to select the menu.

- ▶ Porridge, Non Pressure Steam, Non pressure cook option can be preset after setting the time for the option. When the set time is longer than 60minutes, the preset time will be set as 2 hours.
- ▶ If you do not set a specific option, the default will preset as Non Pressure White Rice.

### 4 Press the Non pressure cook button.

- ▶ Preset cooking proceeds with a voice comes up saying "non pressure White Rice(setting menu) has been reserved"
- ▶ When the preset mode begins, the preset light will stop blinking and the preset time will go down by minute until it starts the preset cooking.

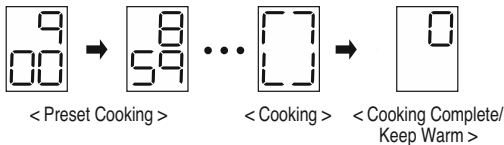

- ▶ The preset time displayed on the screen is the remaining time until completed cooking. (The completion time may vary depending on either the use condition or the cooking capacity)

# TO KEEP COOKED RICE WARM AND TASTY

## Having a meal

- ▶ If you want to have warm rice, press the “KEEP WARM/REHEAT” button. Then “Reheat” function will be started and you can eat fresh rice in 9 minutes.
- ▶ To use reheating in standby mode after power is applied, turn the Lock/Unlock handle to “High pressure 𠄎”. Press “Keep Warm/Reheat” button, and the cooker will convert to Heat Preservation mode. Then press “Keep Warm/Reheat” button once more time.

### < Keep warming >

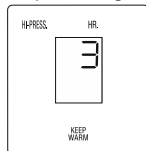

3 Indicates the time elapsed as warming time.

### < Reheating >

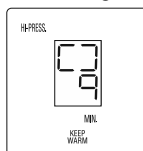

The signal blinks and “” indicator will show the reheat remaining time displayed in minutes with the mark going around clockwise.

### < Finishing reheat >

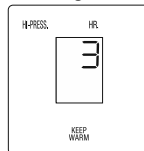

When the reheat finishes with the beep sound, keep warming function will be operated and show the time elapsed.

- ▶ The frequent use of the Reheat function may cause the cooked rice to be discolored or dried. Use it once or twice per day.
- ▶ If a separate heating appliance or gas burner is used to cook rice, put the cooked rice into the cooker and press the “Keep Warm/Reheat” button to keep the rice warm. At this time, “” is shown on the display. (Like this, transferring hot rice to a cold cooker may cause the rice to be discolored or develop an odor)

## Cautions for Keeping Warm

It will be hard to open the lid during warming, or right after it has finished cooking. So push the pressure weight to the side and allow the steam to release.

Make sure the handle is in the 'High pressure' position during warming or reheating.

It is recommended to evenly stir the cooked rice after cooking. The rice taste is improved. (For a small quantity of rice, pile up the rice on the center area of the inner pot to keep warm)

Do not keep the scoop inside the pot while warming the rice. When using a wooden scoop it can create serious bacteria and odors.

If the inner pot is empty during warming, or after it has finished cooking, please press the CANCEL button and unplug the power.

It would be better to warm the rice for less than 12 hours because of odors and color change.

The cooked rice, which cooked by pressure cooker is more prone to changing color than the rice cooked by general cooker. During warm mode, the rice can arise and turn white and rise. In this case, mix the rice.

The mixed and brown rice cannot be in such good condition as white rice while in warm function due to their characteristics. Therefore do not keep mixed and brown rice in function for a long period of time.

Do not mix small amount of rice or leftovers with the rice under keeping warm. Doing so may cause an odor. (Use a microwave oven for the cold rice.)

## When Odors are Rising During the Warming Mode

- ▶ Clean the lid frequently. It can cause growth of bacteria and odors.
- ▶ Even though exterior looks clean, there might be germs and it can cause odor so please be sure to use automatic sterilization (steam cleaning) menu for cleaning. Clean the inner pot completely after automatic cleaning function is done. (Refer to page 25)
- ▶ Clean the inner pot properly to prevent rice from smelling after you cook soups and steamed dishes.

# TO KEEP COOKED RICE WARM AND TASTY

## Controlling Method of Warming Temperature

If the temperature in the rice cooker is not set properly, an odor or the color of the rice may change even though it is cleaned frequently and boiled up. Temperature needs to be set.

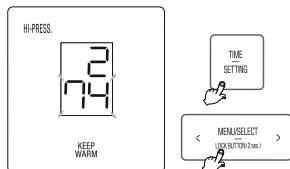

- 1 Press "TIME/SETTING" button for 2 seconds at standby mode to enter voice setting mode. Press "TIME/SETTING" 2 time to enter the warming temperature setting mode. The display will show as seen in the image. 74 current keep warm temperature will show.

- 2 Press "MENU/SELECT" button so that the display shifts.

74 → 75 → 76 → 77 → 78 → 79 → 80 → 83 → 70 → 71 → 72 → 73

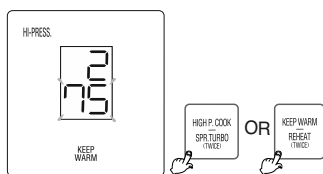

- 3 After setting the desired temperature, press "HIGH Pressure Cook/Super Turbo" or "Keep Warm/Reheat" button to automatically input the selected temperature and enter the standby mode (if you press "CANCEL" button or do not operate for 7 seconds, setting will be cancelled and you will go back to standby mode.) (When you press "TIME/SETTING" button, you will enter the customized Keep Warm setting mode without saving the changed value.)

### Device Temperature Control

1. When you smell bad odors and the rice is too watery : The keep warm temperature is too low. In this case, increase the "Keep Warm" temperature by 2-3°C.
2. When the rice has a yellowish color or is too dry : The Keep Warm temp is too high. In this case decrease the "Keep Warm" temperature by 2-3°C.

## How to Customize Flavor & Texture

Use it while opening the lid when there is too much water or rice becomes too soft.

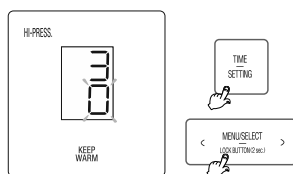

- 1 Press "TIME/SETTING" button for 2 seconds at standby mode to go to voice setting mode. Press "TIME/SETTING" 3 times to enter the customized Keep Warm setting mode.

- 2 Press the "MENU/SELECT" button so that the display shifts.  
0 → 1 → 2 → -2 → -1 → 0

- 3 After setting the desired temperature, press "HIGH Pressure Cook/Super Turbo" or "Keep Warm/Reheat" button to automatically input the selected temperature and enter the standby mode (if you press "CANCEL" button or do not operate for 7 seconds, setting will be cancelled and you will go back to standby mode.) (When you press "TIME/SETTING" button, you will enter the customized taste setting mode without saving the changed value.)

1. If too much water is spilled out when you open the lid : Press "MENU/SELECT" button to raise the setting mode.
2. If the edge of rice is too soft : Press "MENU/SELECT" button to reduce the setting mode.

# TROUBLESHOOTING

▼ Before reaching out to CUCKOO Customer Service, check the following troubleshooting chart to remedy the issue.

Case	Possible Causes	Corrections
The rice is undercooked	<ul style="list-style-type: none"> <li>Is the HIGH Pressure Cook/Super Turbo button pressed?</li> <li>Was the power compromised during the cooking process?</li> </ul>	<ul style="list-style-type: none"> <li>Press the HIGH Pressure Cook/Super Turbo button once and check that "E-3" is shown on the display.</li> <li>Refer to page 22.</li> </ul>
The rice is over cooked.	<ul style="list-style-type: none"> <li>Did you use rice measuring cup to measure your ingredients?</li> <li>Did you measure the proper water amount?</li> <li>Did you rinse the rice before cooking?</li> <li>Did you soak the rice for too long before cooking?</li> <li>Is the rice expired or old?</li> </ul>	<ul style="list-style-type: none"> <li>Refer to page 23.</li> <li>Add water about half the notch and then cook.</li> </ul>
Mixed Rice is not fully cooked.	<ul style="list-style-type: none"> <li>Is the rice dry?</li> </ul>	<ul style="list-style-type: none"> <li>Soak the pea in water before cooking them.</li> </ul>
Rice is too watery or stiff.	<ul style="list-style-type: none"> <li>Was the correct function entered to match the type of rice or grain being cooked?</li> <li>Did you measure the proper water amount?</li> <li>Did you open the lid often during the cooking process?</li> </ul>	<ul style="list-style-type: none"> <li>Selected the correct menu.</li> <li>Measure the proper water.</li> <li>Open the lid after cooking finished.</li> </ul>
Water or food residue is overflowing from the inner pot.	<ul style="list-style-type: none"> <li>Did you use the rice measuring cup to measure ingredients?</li> <li>Did you measure the proper water amount?</li> <li>Did you open the lid often during the cooking process?</li> <li>Was the correct function entered to match the type of rice or grain being cooked?</li> </ul>	<ul style="list-style-type: none"> <li>Refer to page 23.</li> </ul>
When you smell odors while warming.	<ul style="list-style-type: none"> <li>Was the lid properly closed before beginning to warm?</li> <li>Is the power cord securely plugged into an appropriate wall outlet?</li> <li>Was the cooker set to warm for more than 12 hours?</li> <li>Is there any other substance in the rice cooker such as the rice scoop?</li> </ul>	<ul style="list-style-type: none"> <li>Close the lid properly and securely.</li> <li>The maximum amount of time warm mode should be activated is 12 hours.</li> </ul>
The display shows "E--", "E-P", "E-t"	<ul style="list-style-type: none"> <li>The temperature sensor is damaged or not working properly.</li> </ul>	<ul style="list-style-type: none"> <li>Contact CUCKOO Customer Service Center.</li> </ul>
Keep Warm Alarm	<ul style="list-style-type: none"> <li>24 hours has not passed yet after keeping warm</li> </ul>	<ul style="list-style-type: none"> <li>This function alarms if the rice remained warm for more than 24 hours.</li> </ul>
The display shows "E03"	<ul style="list-style-type: none"> <li>Did you use 220V power plug?</li> </ul>	<ul style="list-style-type: none"> <li>It represents the product is malfunction(heater is damaged or heating volume is low ), rice is undercooked for a long time, please turn off the power and contact Customer Service center.</li> <li>It is normal to show "E03" signal after boiling water only for a long time.</li> <li>It is Product applicable for 120V only. Please use the power supply properly.</li> </ul>
The display shows "E00"	<ul style="list-style-type: none"> <li>It shows on the display when pressing HIGH Pressure Cook/Super Turbo button again, or when the cooking has finished and you've never turned the handle to "non pressure".</li> </ul>	<ul style="list-style-type: none"> <li>It can be solved by turning handle to "non pressure". and then turn to 'high pressure'.</li> </ul>

# TROUBLESHOOTING

▼ Before reaching out to CUCKOO Customer Service, check the following troubleshooting chart to remedy the issue.

Case	Possible Causes	Corrections
The display shows 'LJ'.	<ul style="list-style-type: none"> <li>Is the inner pot inserted?</li> <li>Is it used in 220V (Power supply)?</li> </ul>	<ul style="list-style-type: none"> <li>Please insert inner pot.</li> <li>This product is AC 120V only.</li> </ul>
When the HIGH Pressure Cook/Super Turbo button does not operate with 'EQ'.	<ul style="list-style-type: none"> <li>Did you turn the Lock/Unlock handle to "high pressure" or "non pressure" direction?</li> <li>Is "high pressure" or "non pressure" signal light on?</li> </ul>	<ul style="list-style-type: none"> <li>Make sure to close the lid and turn the Lock/Unlock handle to "high pressure" or "non pressure" while cooking. You cannot select menu if the pressure mode is not correctly selected.</li> </ul>
The cooked rice is very sticky and/or mushy.	<ul style="list-style-type: none"> <li>Is there any rice or any other alien substance on the temperature sensor or the bottom surface of the inner pot?</li> <li>Did you set "Customized Cooking Function"?</li> </ul>	<ul style="list-style-type: none"> <li>Clean all the alien substance on the temperature sensor or the bottom surface of the inner pot.</li> <li>Stop cooking or set "Customized Cooking function" for cooking according to needs.</li> </ul>
"J->α" mark and "unlock" mark are flashing	<ul style="list-style-type: none"> <li>Is the lid open?</li> </ul>	<ul style="list-style-type: none"> <li>When cooking, keeping warm, or making reservations, please close the lid and proceed.</li> <li>If you do not close the lid during cooking, there is a risk of burns due to hot steam.</li> </ul>
There is a slight odor being emitted after the cooking or warming process.	<ul style="list-style-type: none"> <li>Did you clean it after cooking?</li> </ul>	<ul style="list-style-type: none"> <li>Please follow Operating Instruction on how to clean detachable cover and pressure packing.</li> </ul>
The lid will not close.	<ul style="list-style-type: none"> <li>Is the Lock/Unlock handle on the LID set to 'non pressure'?</li> <li>Is there hot food in the inner pot?</li> <li>Is the inner pot correctly inserted in the main body?</li> </ul>	<ul style="list-style-type: none"> <li>Please turn the Lock/Unlock handle to 'non pressure'.</li> <li>Make the pressure weight tilted and then close the cover</li> <li>Insert the inner pot properly.</li> </ul>
The display shows 'E_P'	<ul style="list-style-type: none"> <li>Problem on environment sensor</li> </ul>	<ul style="list-style-type: none"> <li>Unplug power and contact to Customer Service center.</li> </ul>
The display shows 'EUF', 'EEP'	<ul style="list-style-type: none"> <li>Problem on micom memory</li> </ul>	<ul style="list-style-type: none"> <li>Unplug power and contact to Customer Service center.</li> </ul>

# TROUBLESHOOTING

▼ Before reaching out to CUCKOO Customer Service, check the following troubleshooting chart to remedy the issue.

Case	Possible Causes	Corrections
The cooker is unable to turn to "non pressure" mode.	<ul style="list-style-type: none"> <li>• Did you turn the Lock/Unlock handle before exhausting steam thoroughly?</li> </ul>	<ul style="list-style-type: none"> <li>• Don't open the lid while cooking. If you want to open the lid while cooking, press "CANCEL" button more than 2 seconds and release the steam.</li> <li>• Pull the pressure handle to aside once until the steam is fully released.</li> </ul>
The lid will not open when set to "non pressure" mode.		<ul style="list-style-type: none"> <li>• Pressure is still remaining in the cooker</li> <li>• Pull the pressure handle to aside once until the steam is fully exhausted.</li> </ul>
There is excess steam being released from the lid.	<ul style="list-style-type: none"> <li>• Is there an external substance on the packing?</li> <li>• Is packing too old?</li> </ul>	<ul style="list-style-type: none"> <li>• Clean the packing thoroughly.</li> <li>• If the steam is released through the lid, please power off and contact Customer Service center.</li> <li>• Cover packing life cycle is 12 – 36 months.</li> </ul>
The CANCEL button is not functioning while cooking.	<ul style="list-style-type: none"> <li>• Is the inner pot hot?</li> </ul>	<ul style="list-style-type: none"> <li>• Keep pressing the "CANCEL" button for 2 seconds for safety reason if you want to cancel while cooking.</li> <li>• Be careful of hot steam emission or hot contents spattered from the automatic steam outlet during cancellation.</li> </ul>
Beans or grains are not fully cooked.	<ul style="list-style-type: none"> <li>• Are they too dry?</li> </ul>	<ul style="list-style-type: none"> <li>• Soak or steam beans and other grains before cooking in the pressure cooker in order to avoid partially cooked beans or grains. Beans should be soaked for-2-minutes or steamed for-2-minutes prior to cooking, depending on your taste.</li> </ul>
Brown rice is not properly germinated.	<ul style="list-style-type: none"> <li>• Is your germination amount more than brown rice limit?</li> <li>• Did you use old brown rice?</li> </ul>	<ul style="list-style-type: none"> <li>• Please put the advisable brown rice amount.</li> <li>• If you use old or dirty brown rice, it will affect the germination.</li> </ul>
The display shows "E11".	<ul style="list-style-type: none"> <li>• Problem on smart locking system</li> </ul>	<ul style="list-style-type: none"> <li>• Unplug power and contact to Customer Service center.</li> </ul>
The display shows "E12".	<ul style="list-style-type: none"> <li>• Problem on smart locking system</li> </ul>	<ul style="list-style-type: none"> <li>• Please do not open the lid until cooking is completely finished.</li> <li>• Error occurs during warming or stand by mode, please open the lid after turn off the power.</li> <li>• Please contact Service center for service inquiry.</li> </ul>



## WHITE RICE(High Pressure Menu) - All cups referenced are using the provided rice measuring cup. (Water:180ml, Rice:150g)

### :: Boiled Rice



#### Ingredients

Rice 6 cups(900g)  
\* 1 cup (180ml) is for one person.

#### Recipe

- ① Put clean-washed rice in the inner pot and pour water by water inner pot level line WHITE RICE 6.
- ② Firstly, lock the cover, and select [WHITE RICE] in the menu, and then push the [HIGH Pressure Cook/Super Turbo] button.
- ③ Fluff the rice to loosen and serve.

#### Reference

According to gradation on the inside of inner pot, when cooking with newly harvested rice the amount of water should be less than the gradation, and when cooking with old rice the amount of water should be more than gradation.(Control the amount of water according to preference of each family)

### :: Pea Rice



#### Ingredients

3 cups of rice(450g), 1/2 cup of pea(75g), 1 tablespoonful of sake, 1.5 teaspoonful of salt  
\* Boil pea before cooking.

#### Recipe

- ① As for peas, add salt into them, wash them clean and extract water from them.
- ② Put cleanly washed rice into inner pot, season them with sake and salt, and pour water up to WHITE RICE water gradation 3.
- ③ Place peas on top of them, press menu button after locking the lid, select [WHITE RICE], and press [HIGH Pressure Cook/Super Turbo] button.
- ④ When the cooker comes to Heat Preservation mode, mix the cooked grains properly.

#### Store peas as follows

If peas and kidney beans etc are stored in the refrigerator, they change in color and decrease in freshness fast. Therefore, immediately after getting the materials from the market, blanch them slightly, place them in the refrigerator, and whenever they are needed, take them out to use them in natural color and freshness.

## MIXED RICE(High Pressure Menu) - All cups referenced are using the provided rice measuring cup. (Water:180ml, Rice:150g)

### :: Boiled Barley



#### Ingredients

2 cups of white rice(300g), a cup of barley(150g)

#### Recipe

- ① Prepare boiled barley with a cup of barley.
- ② Wash rice clean, and after putting it in the pot along with boiled barley, pour water up to MIXED RICE water gradation 3.
- ③ Lock the lid, press menu button, and after selecting [MIXED RICE], press [HIGH Pressure Cook/Super Turbo].
- ④ Once the cooker comes to Heat Preservation mode, mix the cooked grains properly.

### :: Five-grain Rice



#### Ingredients

Rice 2 1/3 cup(350g), millet 1/3cup(50g), White Rice 2/3cup(100g), red beans 1/3cup(50g), sorghum 1/3cup(50g) and salt 1 teaspoon

#### Recipe

- ① Wash rice, White Rice, millet and sorghum clean and scoop them with a landing net.
- ② Boil red beans on high heat, and then put only water in which red beans were boiled in another bowl.
- ③ Put rice, White Rice, millet and sorghum on a landing net into the inner pot and pour water in which red beans were boiled and water by MIXED RICE water gradation 4.
- ④ Put the boiled red beans, and then lock the cover. After select [MIXED RICE], press [HIGH Pressure Cook/Super Turbo].
- ⑤ Mix rice when cooking is finished.

#### Reference

Oriental medicine calls red beans as Jeeksodu which holds moisture, removes steam and discharges accumulated pus as well as relieving edema by making thirst and diarrhea stopped and bladder empty.

# COOKING GUIDE

## MIXED RICE(High Pressure Menu) -All cups referenced are using the provided rice measuring cup. (Water:180ml, Rice:150g)

### :: Millet



#### Ingredients

Rice 840g, Millet 360g

#### Recipe

- 1 Wash rice and Millet clean, put them in the Inner pot, and pour water up to MIXED RICE water gradation 8.
- 2 Lock the lid, press menu button, and after selecting [MIXED RICE], press [HIGH Pressure Cook/Super Turbo].
- 3 Mix rice when cooking is finished.

### :: Kamut



#### Ingredients

Rice 840g, Kamut 360g

#### Recipe

- 1 Wash rice and Kamut clean, put them in the Inner pot, and pour water up to MIXED RICE water gradation 8.
- 2 Lock the lid, press menu button, and after selecting [MIXED RICE], press [HIGH Pressure Cook/Super Turbo].
- 3 Mix rice when cooking is finished.

## GABA RICE(High Pressure Menu) - All cups referenced are using the provided rice measuring cup. (Water: 80ml, Rice:150g)

### :: Fresh Germinated Brown Rice



#### Ingredients

Brown rice 4 cups(600g)

#### Recipe

- 1 Put washed brown rice into the inner pot, and then put it into the inner pot and pour water by GABA RICE water gradation 4.
- 2 After locking the cover and choosing [GABA RICE] in the menu, push the button of [HIGH Pressure Cook/Super Turbo] button after setting up the time of germinated brown rice for 3 hours.
- 3 Mix rice when cooking is finished.

#### Reference

- Control the time of germinated brown rice according to each preference.
- When cooking with germinated brown rice, set up germinating time for 0 hour if you want to have 100% boiled brown rice without germination.

### :: Boiled Brown Rice with Red Beans



#### Ingredients

Brown rice 1 cup(150g), rice 2 cups(300g) and red beans 1/3 cup(50g)

#### Recipe

- 1 Boil red beans until it become soft, but not to break the shape of red beans and separate it from water.
- 2 Wash brown rice clean and put it in the inner pot. Put the boiled red beans after pouring water by germinated GABA RICE water scale 3.
- 3 After locking the cover and choosing [GABA RICE] in the menu, push the button of [HIGH Pressure Cook/Super Turbo] button after setting up the time of germinated brown rice for 3 hours.
- 4 Mix rice when cooking is finished.

## GABA RICE(High Pressure Menu) - All cups referenced are using the provided rice measuring cup. (Water: 80ml, Rice:150g)

### :: Green Tea Rice with Chicken Breast



#### Ingredients

2 cups of brown rice, 3g of green tea leaf, 10g of green tea powder, 4 nuggets of Chicken breast flesh, a little bit of olive oil, a little bit of salt, a little bit of pepper, 5g of celery, a little bit of lime, a little bit of rosemary

#### Recipe

- ① Wash brown rice clean, put the brown rice into My Caldron along with 10g of green tea powder and 3g of green tea leaf, and pour water up to GABA RICE water graduation 2.
- ② Lock the lid, press menu button, and after selecting [GABA RICE] and setting Germinated Brown Rice Time to 3 hours, press [HIGH Pressure Cook/Super Turbo] button.
- ③ Pickle chicken chest flesh in salt and pepper for 1 hour or so, put olive oil in the pan, and after frying the flesh in the pan, slice it thin.
- ④ Prepare lime by slicing it in half moon shape, and prepare shredded celery.
- ⑤ Mix the cooked rice and chicken in a large bowl. Add lime and celery on top.

#### 10 Long Points of Green Tea

Anticarcinogenic property, anti-aging effect, prevention of lifestyle disease, prevention of obesity and diet, detoxication of heavy metals and nicotine, recovery from fatigue and removal of hangover, treatment of constipation, prevention of caries, prevention of acidification of constitution, inhibition of inflammation and bacterial contagion.

### :: Saessak Bibimbap(rice with sprout and vegetables)



#### Ingredients

2 cups of brown rice(300g) and some sprouts and vegetables  
Seasoning red pepper paste : Red pepper paste 1/2cup(75g), beef (crushed) 40g, sesame oil 1 tablespoon, honey 1 tablespoon and sugar 1 tablespoon, water 1/3cup(60ml)

#### Recipe

- ① Wash brown rice clean, put it into the inner pot and pour water by germinated GABA RICE water graduation 2.
- ② After locking the cover and choosing [GABA RICE] in the menu, push [HIGH Pressure Cook/Super Turbo] button after setting up the time of germinated brown rice for 3 hours.
- ③ Pour sesame oil in a pot and stir-fry the crushed beef. Stir-fry it a little more after stirring up it with red pepper paste and 1/3cup of water in order to be thick put sugar, honey and sesame oil.
- ④ Stir the rice when it's done cooking, put the prepared sprouts and vegetables on germinated brown rice.
- ⑤ Add the seasoning to your liking on top of the rice. Do not over stir the rice it may damage the form of the sprouted grain.

- Broccoli sprout : Prevention of cancer
- Chinese cabbage sprout : Good at stomach and improve constipation
- Turnip sprout : improve hepatitis and jaundice
- Cabbage sprout : include selenium preventing aging and cancer
- Daikon sprout : Lower heat and make the swelling subside
- Wheat sprout : purify blood

### :: Mushroom Tian



#### Ingredients

2 cups of brown rice(300g), 20g of brown gravy sauce, a little bit of salt, 2 sheets of sesame leaves, 1/3 pieces of pumpkin, a pack of shimeji mushroom  
※ Mushroom may be chosen as preferred in the family.

#### Recipe

- ① Wash brown rice clean, put it in the inner pot, and pour water up to germinated GABA RICE water graduation 2.
- ② Lock the lid, press menu button, select [GABA RICE], and after setting germinated brown rice time to 3 hours, press [HIGH Pressure Cook/Super Turbo] button.
- ③ Chop pumpkin small, and fry them slightly after adding salt.
- ④ Mix mushroom with brown gravy sauce slightly.
- ⑤ When the rice cooker comes to Keep Warm mode, mix the cooked grains properly.
- ⑥ Put germinated brown rice in the mold, add fried pumpkin, and then after putting germinated brown rice again and evening it, take out from the mold.
- ⑦ Heap up mushroom mixed with brown gravy sauce, and place shredded sesame leaf.

### :: Millet 100%



#### Ingredients

Millet 6cups (900g)  
(Millet 1cup: 150g)

#### Recipe

- ① Wash Millet clean, put them in the Inner pot, and pour water up to GABA RICE water graduation 6.
- ② Lock the lid, press menu button, and after selecting [GABA RICE], press [HIGH Pressure Cook/Super Turbo].
- ③ Mix rice when cooking is finished.

# COOKING GUIDE

## NON PRESSURE WHITE RICE(Non Pressure Menu)

### ⚠ Non pressure Rice Cautions

- All cups referenced are using the provided rice measuring cup. (Water: 180ml, Rice: 150g)
- Do not exceed the cooker's capacity. If exceeded, there is a risk of overflow and potential product damage. This may cause the overflow.

### :: Boiled Rice



#### Ingredients

Rice 4cups(600g), \* 1 cup (180ml) is for one person.

#### Recipe

- 1 Put clean-washed rice in the inner pot and pour water by water inner pot level line NON P RICE 4.
- 2 Close the lid and turn the handle to 'Non Pressure' mode.
- 3 After selecting [NON PRESSURE RICE], press [NON PRESSURE COOK] button.
- 4 Mix rice when cooking is finished.

#### Reference

- Control the time of germinated brown rice according to each preference.
- When cooking with germinated brown rice, set up germinating time for 0 hour if you want to have 100% boiled brown rice without germination.

### :: Sushi



#### Ingredients

3 cups of rice(450g), 1 piece of kelp (4cmx4cm), suitable amount of sashimi for sushi, 1T of wasabi  
Rice vinegar : 100g of vinegar, 60g of sugar, 10g of salt, 1/2 of lemon

#### Recipe

- 1 Put rinsed rice into an inner pot, pour water to the scale 3 of white rice, put 1 piece of kelp.
- 2 Close the lid and turn the handle to "Non Pressure" mode.
- 3 After choosing [NON PRESSURE RICE] with menu button, and press [NON PRESSURE COOK] button.
- 4 After cooking, remove the kelp, stir the rice, and put it to the bowl.
- 5 Put ingredients for white vinegar in the pot, boil it until sugar and salt are melted, and cool it down.
- 6 Put lemon on the white vinegar. (Lemon helps yield flavor, so it is optional.)
- 7 Mix the rice with white vinegar.  
Hold the rice scooper straightly when mixing, so that rice is not crushed. (The amount of white vinegar is optional.)
- 8 Put a cloth for a moment, so that rice and white vinegar can be mixed.
- 9 Dip your fingers into cold water, ball the right amount of rice together in your hand, and then put wasabi on it.
- 10 Lay fish filets on top of it and shape it as sushi with hand.
- 11 Put hand-made sushi on the plate.

#### Reference

- Put white vinegar on hot rice and mix it. When the rice is cooled down, the white vinegar may not be mixed with rice grains.

## VEGGIE RICE(Non Pressure Menu)

### ⚠ VEGGIE RICE Cautions

- All cups referenced are using the provided rice measuring cup. (Water: 180ml, Rice: 150g)
- Do not exceed the cooker's capacity. If exceeded, there is a risk of overflow and potential product damage. This may cause the overflow.

### :: Rice cooked with bean sprouts

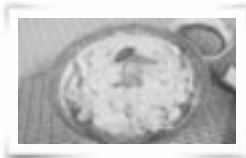

#### Ingredients

3 cups of rice(450g), bean sprouts(150g)  
Sauce: 4 tablespoons of soy sauce, 1/2 tablespoons of red chili powder, 2 teaspoon of sesame salt,  
2 tablespoons of chopped green onion, 1/2 tablespoons of minced garlic, 1 teaspoon of sesame oil

#### Recipe

- 1 Boil the bean sprouts.
  - 2 Put the rinsed rice in an inner pot, pour water to the scale 3 of NON P RICE, and put bean sprouts.
  - 3 Close the lid and turn the handle to 'Non Pressure' mode.
  - 4 After selecting [VEGGIE RICE], press [NON PRESSURE COOK] button.
  - 5 After cooking, eat it with sauce.
- \* Remove the bean pod, and then start cooking.

### :: Rice with white radish



#### Ingredients

3 cups of rice(450g), radish(200g)  
Sauce: 4 tablespoons of soy sauce, 1/2 tablespoons of red chili powder, 2 teaspoon of sesame salt,  
2 tablespoons of chopped green onion, 1/2 tablespoons of minced garlic, 1 teaspoon of sesame oil

#### Recipe

- 1 Cut white radish into strips.
- 2 Put rinsed rice into an inner pot, pour water to the scale 3 of NON P RICE, and put the slices of white radish.
- 3 Close the lid and turn the handle to 'Non Pressure' mode.
- 4 After selecting [VEGGIE RICE], press [NON PRESSURE COOK] button.
- 5 After cooking, eat it with sauce.

## VEGGIE RICE(Non Pressure Menu)



### VEGGIE RICE Cautions

- All cups referenced are using the provided rice measuring cup. (Water: 180ml, Rice: 150g)
- Do not exceed the cooker's capacity. If exceeded, there is a risk of overflow and potential product damage. This may cause the overflow.

### :: Quinoa



#### Ingredients

Rice 630g, Quinoa 270g

#### Recipe

- 1 Wash Rice and Quinoa clean, put them in the Inner pot, and pour water up to NON P GLUTIN water gradation 6.
- 2 Close the lid and turn the handle to 'Non Pressure' mode.
- 3 Press menu button, and after selecting [VEGGIE RICE], press [NON PRESSURE COOK].
- 4 Mix rice when cooking is finished.

### :: Quinoa 100%



#### Ingredients

Quinoa 6cups (810g)  
(Quinoa 1cup: 135g)

#### Recipe

- 1 Wash Quinoa clean, put them in the Inner pot, and pour water up to NON P GLUTIN water gradation 6.
- 2 Close the lid and turn the handle to 'Non Pressure' mode.
- 3 Press menu button, and after selecting [VEGGIE RICE], press [NON PRESSURE COOK].
- 4 Mix rice when cooking is finished.

## NON P STEAM(Non Pressure Menu)



### Steam Cautions

- All cups referenced are using the provided rice measuring cup. (Water: 180ml, Rice: 150g)
- Do not exceed the cooker's capacity. If exceeded, there is a risk of overflow and potential product damage. This may cause the overflow.

### :: Oatmeal



#### Recipe

- 1 Add steel cut oatmeal and water/milk into the inner pot. For precise measurement, please refer to the table below.
- 2 Close the lid and turn the handle to 'Non Pressure' mode.
- 3 Choose [NON PRESSURE STEAM] menu, and press [NON PRESSURE COOK] button.
- 4 After cooking has been completed, stir well and enjoy.

► Serving size and cooking time can be selected according to taste.

Ingredients (Using Rice Measuring Cup)	1 person	2 person
Steel Cut Oatmeal	1cup(65g)	2cups(130g)
Water	1+1/2cups(270ml)	2+3/4cups(495ml)
Cooking Time	10min	10min
Ingredients (Using Rice Measuring Cup)	1 person	2 person
Steel Cut Oatmeal	1cup(65g)	2cups(130g)
Milk	1+3/4cups(315ml)	3cups(540ml)
Cooking Time	15min	20min

# COOKING GUIDE

## PORRIDGE(Non Pressure Menu)

### PORRIDGE Cautions

- All cups referenced are using the provided rice measuring cup. (Water: 180ml, Rice: 150g)  
- Do not exceed the cooker's capacity. If exceeded, there is a risk of overflow and potential product damage. This may cause the overflow.

### :: Special Chicken Porridge



#### Ingredients

Rice 1cup(150g), chicken 100g, chicken soup 300cc, green pepper 1 unit, red pepper 1 unit and some salt Seasoning: Chopped scallion 1 tablespoon, crushed garlic 1 tablespoon, soy sauce 2 tablespoons, some ground sesame mixed with salt, sesame oil 2 teaspoons and some ground pepper

#### Recipe

- 1 Wash rice clean and put it in water for more than one hour.
- 2 Boil well-trimmed chicken for a long time. Tear it into pieces and season them with the above materials.
- 3 Separate seeds from red peppers and green peppers and chop them into pieces.
- 4 Remove oil from chicken soup and put it on absorbent gauze.
- 5 Put step No. 1, 2 and 3 into the inner pot and pour the chicken soup.
- 6 Pour water by nutrition porridge water "scale 1.5".
- 7 Close the lid and turn the handle to "Non Pressure" mode.
- 8 After choosing [PORRIDGE] in the menu, push [NON PRESSURE COOK] button after setting up the time of porridge for 60minutes.
- 9 Mix rice when cooking is finished and stir it with salt according to your preference.

### :: White Porridge



#### Ingredients

Rice 1cup(150g)

#### Recipe

- 1 Wash rice clean and put it into the inner pot. And pour water by nutrition porridge water "scale 1".
- 2 Close the lid and turn the handle to "Non Pressure" mode.
- 3 After choosing [PORRIDGE] in the menu, push [NON PRESSURE COOK] button after setting up the time of porridge for 50minutes.

#### Porridge is one of the oldest food developed in our tradition and culture.

It is presumed that people in the New Stone Age with agricultural culture boiled grain with water. It is the origin of porridge.

### :: Red Bean Porridge



#### Ingredients

2/3 cups of rice(100g), 1/3 cups of red bean(50g), 2/3 cups of White Rice(100g)

#### Recipe

- 1 Wash rice clean, and soak it in water for 30 minutes or more.
  - 2 Boil red bean in strong fire, throw away red bean water, and boil it again slowly until red bean blasts in weak fire by pouring water again.
  - 3 Put the boiled red bean with sieve, and filter only red bean water by crushing.
  - 4 Boil White Rice powder taken out from sieve of No. 2 to 3, and after pasting it with cooled water, make small dumpling in red-bean gruel.
  - 5 Put previously soaked rice into My Caldron, and pour red bean water up to Nutritious Porridge water graduation 1.5.
  - 6 Close the lid and turn the handle to "Non Pressure" mode.
  - 7 After choosing [PORRIDGE] in the menu, push [NON PRESSURE COOK] button after setting up the time of porridge for 60minutes.
- \* For chewy taste, red bean grains may be used depending on preference.

## NON P STEAM/HIGH P STEAM(Non P Menu/High P Menu)

### Steam Cautions

- All cups referenced are using the provided rice measuring cup. (Water: 180ml, Rice: 150g)
- Do not exceed the cooker's capacity. If exceeded, there is a risk of overflow and potential product damage. This may cause the overflow.

### :: Steamed Rice Cake



**Non P Steam time** 55min

**High P Steam time** 45min

#### Ingredients

2.5 cups of nonWhite Rice(375g), 1 cups of red beans(150g), 0.5 tablespoonful of salt, 2.5 tablespoonful of sugar and 1.5 tablespoonful of water

#### Recipe

- 1 Put 1.5 tablespoonful of water into 2.5 cups of nonWhite Rice, and after mixing properly and sieving them once, mix with 1.5 tablespoonful of sugar.
- 2 As for red beans, add salt(0.5 tablespoonful) and sugar(1 tablespoonful) while pounding them roughly by boiling free of water content.
- 3 Put steaming plate after pouring 2 cups of water(360ml) into the inner pot, spread cloth of proper size by cutting it.
- 4 Spread 0.5 cup of red bean crumbs, put steaming plate evenly, and create layers by adding 0.5 cup of red bean crumbs again.
- 5 Close the lid, turn the handle to high pressure mode, press Menu button and select [HIGH PRESSURE STEAM]. Then set the cooking time and press Cooking with [HIGH Pressure Cook/Super Turbo] button. Close the lid, turn the handle to no pressure mode, press Menu button and select [NON PRESSURE STEAM]. Then set the cooking time and press [NON PRESSURE COOK] button.

### :: Steamed Rib



**Non P Steam time** 45min

**High P Steam time** 35min

#### Ingredients

Beef rib port rib 700g, sake 2 tablespoons, nicely aged soy sauce 3tablespoons, crushed garlic 1/2 teaspoon, sesame oil 1/2 teaspoon, onion juice 1 tablespoons, pear juice 1 tablespoons, sugar 1 tablespoons, chopped scallion 3 tablespoons, ground sesame mixed with salt 1/2 teaspoon, ground pepper 1/2 teaspoon, carrot 1/2 unit, chestnut 3 units, ginkgo nut 6 units and ground pine nuts 1/2 tablespoon

#### Recipe

- 1 Remove fat and tendons from chopped rib and remove blood by putting it in cold water.
- 2 Remove water by scooping it with a basket and keep the rib smooth by marinating it in sake and pear juice.
- 3 Peel the skins of chestnuts and divide large chestnuts into two pieces. Stir-fry ginkgo nuts with oil and peel the skins of ginkgo nuts. Cut carrots into chestnut-size pieces.
- 4 Mix all the prepared ingredients with seasoning and marinate them for one hour. After that, put them in the inner caldron (It is not necessary to pour additional water since it is cooked with moisture from ribs and marinade)
- 5 Close the lid, turn the handle to high pressure mode, press Menu button and select [HIGH PRESSURE STEAM]. Then set the cooking time and press Cooking with [HIGH Pressure Cook/Super Turbo] button. Close the lid, turn the handle to no pressure mode, press Menu button and select [NON PRESSURE STEAM]. Then set the cooking time and press [NON PRESSURE COOK] button.
- 6 After cooking is completed, scatter ground pine nuts on the steamed rib.

### :: Steamed Chicken



**Non P Steam time** 45min

**High P Steam time** 35min

#### Ingredients

1 chicken (700g), potato50g, carrot50g, sugar 1 tablespoon, chopped scallion 1 teaspoon, crushed garlic 1 teaspoon, nicely aged soy sauce 3 tablespoons, ginger juice 1teaspoon, ground pepper 1/2teaspoon, ground sesame mixed with salt 1 tablespoon and sesame oil 1 tablespoons.

#### Recipe

- 1 Wash a chicken, clean and remove feathers and internal organs and cut the fat in the tail.
- 2 After cutting the chicken into a suitable eating size, make cuts in the chicken to make it well seasoned and to roast quickly.
- 3 After putting carrots, potatoes and sliced chicken in a large bowl and mixing them with prepared seasoning, marinate.
- 4 Put enough marinated chicken, potatoes and carrots in the inner caldron.
- 5 Close the lid, turn the handle to high pressure mode, press Menu button and select [HIGH PRESSURE STEAM]. Then set the cooking time and press Cooking with [HIGH Pressure Cook/Super Turbo] button. Close the lid, turn the handle to no pressure mode, press Menu button and select [NON PRESSURE STEAM]. Then set the cooking time and press [NON PRESSURE COOK] button.

### :: Boiled Pork



**Non P Steam time** 50min

**High P Steam time** 40min

#### Ingredients

Pork (shank or pork belly) 400g, ginger 1EA, some garlic, onion 1EA, scallion 1EA and some kimchi

#### Recipe

- 1 Put 1.5 cups of water(270ml) in the inner caldron and put the steam plate above it.
- 2 Cut pork into 2~3 pieces and put them on the steam plate with 2~3 pieces of ginger cut into thin slices.
- 3 Close the lid, turn the handle to high pressure mode, press Menu button and select [HIGH PRESSURE STEAM]. Then set the cooking time and press Cooking with [HIGH Pressure Cook/Super Turbo] button. Close the lid, turn the handle to no pressure mode, press Menu button and select [NON PRESSURE STEAM]. Then set the cooking time and press [NON PRESSURE COOK] button.
- 4 After cooking is completed, put the pork on a plate with onion, garlic, scallion and kimchi.

# COOKING GUIDE

## NON P STEAM/HIGH P STEAM(Non P Menu/High P Menu)

### Steam Cautions

- All cups referenced are using the provided rice measuring cup. (Water: 180ml, Rice: 150g)
- Do not exceed the cooker's capacity. If exceeded, there is a risk of overflow and potential product damage. This may cause the overflow.

### :: Five-flavor Pork



**Non P Steam time** 40min **High P Steam time** 30min

#### Ingredients

400g of pork, 1/3 cup of soy sauce, 2 tablespoonful of sugar, a little bit of silk yarn  
Five flavors : 4 grains of black pepper, 5cm of cinnamon, 2 pieces of star anise

#### Recipe

- 1 Bind pork with silk yarn tightly so that it may be cooked properly.
- 2 Put the bound pork in the container, and soak it by adding soy sauce, salt and the five flavors.
- 3 Put the materials of ② into the inner pot, and pour 1/2 cups of water(90ml).
- 4 Close the lid, turn the handle to high pressure mode, press Menu button and select [HIGH PRESSURE STEAM]. Then set the cooking time and press Cooking with [HIGH Pressure Cook/Super Turbo] button. Close the lid, turn the handle to no pressure mode, press Menu button and select [NON PRESSURE STEAM]. Then set the cooking time and press [NON PRESSURE COOK] button.
- 5 Once the cooking is completed, take out the pork and release silk yarn by cutting it with scissors. Cool down five-flavor pork, and put it on the plate by slicing it to 0.2cm thickness.

### :: Hard-boiled Cuttlefish



**Non P Steam time** 25min **High P Steam time** 20min

#### Ingredients

1 squid fish, 70g of spinach, 80g of carrot, 1 egg, a little bit of salt, a little bit of sesame oil, a little bit of wheat powder, 1/2cup of water(90ml)  
Seasoning Sauces: 1 tablespoonful of red pepper paste, 1 tablespoonful of soy sauce, 1 tablespoonful of sugar, 1 tablespoonful of refined rice wine, 1 refined rice wine, 1/2 teaspoonful of sesame oil, 1/2 teaspoonful of red pepper powder

#### Recipe

- 1 Divide squid-fish half, remove intestines, and after washing clean by peeling it off, make cuts both to lengths and breadths inside.
- 2 Put a little bit of salt in boiling water, blanch the body of the cut squid-fish, and blanch the legs as well by trimming them.
- 3 Wash spinach clean by trimming it, blanch it slightly after adding salt, remove water content by rinsing it in cold water, blanch carrot in boiling water by shredding it, and mix both of them with salt and sesame oil.
- 4 Loosen up egg by adding salt in it, and paste it throughout the squid-fish area.
- 5 Wipe water content off the blanched squid-fish, put a little bit of wheat powder inside, and after rolling spinach, carrot and squid-fish legs, fix them with skewer.
- 6 Put the rolled squid-fish, seasoning sauce and half cup water in My Caldron.
- 7 Close the lid, turn the handle to high pressure mode, press Menu button and select [HIGH PRESSURE STEAM]. Then set the cooking time and press Cooking with [HIGH Pressure Cook/Super Turbo] button. Close the lid, turn the handle to no pressure mode, press Menu button and select [NON PRESSURE STEAM]. Then set the cooking time and press [NON PRESSURE COOK] button.

### :: Steak



**Non P Steam time** 25min **High P Steam time** 20min

#### Ingredients

Beef (for steak) 200g, some steak sauce, some salt and some ground pepper

#### Recipe

- 1 After scattering ground pepper and salt on beef to suit its taste, put the beef in the inner caldron and pour 1 cup of water(180ml).
- 2 Close the lid, turn the handle to high pressure mode, press Menu button and select [HIGH PRESSURE STEAM]. Then set the cooking time and press Cooking with [HIGH Pressure Cook/Super Turbo] button. Close the lid, turn the handle to no pressure mode, press Menu button and select [NON PRESSURE STEAM]. Then set the cooking time and press [NON PRESSURE COOK] button.
- 3 After cooking is completed, pour some steak sauce on the steak.

### :: Steamed Blue Crab



**Non P Steam time** 40min **High P Steam time** 30min

#### Ingredients

Blue crab 1EA, beef 150g, tofu 1/4 block, red/green pepper each 1/2EA, yolk 1/2EA and some flour

#### Recipe

- 1 Wash the blue crab clean and separate its body.
- 2 Crush meat of the separated body into thin slices.
- 3 After crushing beef and tofu into thin slices, mix them with the crushed crab meat.
- 4 After crushing red/green pepper into thin slices, mix them with yolk.
- 5 After scattering flour on the crab skin and filling up step no. ④ in the crab skin, cover it with step no. ④.
- 6 Pour one measuring cup of water(180ml) in the inner caldron. Close the lid, turn the handle to high pressure mode, press Menu button and select [HIGH PRESSURE STEAM]. Then set the cooking time and press Cooking with [HIGH Pressure Cook/Super Turbo] button. Close the lid, turn the handle to no pressure mode, press Menu button and select [NON PRESSURE STEAM]. Then set the cooking time and press [NON PRESSURE COOK] button.



## NON P STEAM/HIGH P STEAM(Non P Menu/High P Menu)

### Steam Cautions

- All cups referenced are using the provided rice measuring cup. (Water: 180ml, Rice: 150g)
- Do not exceed the cooker's capacity. If exceeded, there is a risk of overflow and potential product damage. This may cause the overflow.

### ::: Steamed Fish



<b>Non P Steam time</b>	30min	<b>High P Steam time</b>	30min
-------------------------	-------	--------------------------	-------

#### Ingredients

Snapper 1EA, beef 50g, shitake 3EA, stone mushroom 2EA, red pepper 1EA, egg1EA, some scallion, some garlic, some soy sauce, some ground sesame mixed with salt, some cooking oil, some sesame oil, some salt and some ground pepper

#### Recipe

- 1 Make cuts on the well-trimmed snapper at intervals of 2cm.
- 2 Season crushed beef with soy sauce, scallion, ground sesame mixed with salt, garlic and ground pepper.
- 3 Pour the prepared seasoning on the snapper.
- 4 After pouring 1.5 cups of water(270ml) into the inner pot, place the steam plate on it.
- 5 Put the prepared snapper on the steam plate.
- 6 Close the lid, turn the handle to high pressure mode, press Menu button and select [HIGH PRESSURE STEAM]. Then set the cooking time and press Cooking with [HIGH Pressure Cook/Super Turbo] button.
- Close the lid, turn the handle to no pressure mode, press Menu button and select [NON PRESSURE STEAM]. Then set the cooking time and press [NON PRESSURE COOK] button.
- 7 After cooking is completed, decorate it with the remaining garnish.

### ::: Steamed Clam



<b>Non P Steam time</b>	35min	<b>High P Steam time</b>	35min
-------------------------	-------	--------------------------	-------

#### Ingredients

2 clams, 15g of beef, egg white 1/2EA, egg 1/2EA, 1 teaspoonful of minced Welsh onion, 1/2 teaspoonful of minced garlic, 1/4 teaspoonful of salt, a little bit of pepper grounds

#### Recipe

- 1 Mince beef neatly.
- 2 Cut cleanly rinsed clam half, and mince it neatly by taking out flesh attached to shell with knife.
- 3 Put minced beef and clam flesh in the container, and mix evenly by seasoning with minced Welsh onion, minced garlic, salt and pepper grounds.
- 4 Since 4 shells can be contained in the container, put seasoned substances tightly to a degree of 1/2EA per shell.
- 5 As the material may grow sticky, apply egg white evenly on top of clam flesh so that the shape may not be deformed even after steaming.
- 6 Pour 1.5 cups of water(270ml) into inner pot, and place steaming plate.
- 7 Put the prepared clam on the steaming plate.
- 8 Close the lid, turn the handle to high pressure mode, press Menu button and select [HIGH PRESSURE STEAM]. Then set the cooking time and press Cooking with [HIGH Pressure Cook/Super Turbo] button.
- Close the lid, turn the handle to no pressure mode, press Menu button and select [NON PRESSURE STEAM]. Then set the cooking time and press [NON PRESSURE COOK] button.
- 9 Divide fully boiled egg into white and yolk, and after mincing the white neatly and crushing and putting the yolk on the sieve, put the egg yolk and white on the clam half each.

### ::: Multi-Flavor lutinous Rice



<b>Non P Steam time</b>	45min	<b>High P Steam time</b>	35min
-------------------------	-------	--------------------------	-------

#### Ingredients

3 cups of White Rice(450g), 60g of raisin, 15 chestnuts, 10 dates, 1tablespoonful of pine nut, 100g black sugar, 1 tablespoonful of thick soy, 3 tablespoonful of sesame oil, a little bit of salt, 1/2 tablespoonful of cinnamon powder

#### Recipe

- 1 Wash White Rice clean, and soak it in water sufficiently for 1 hour or longer.
- 2 Prepare chestnuts and dates by cutting them to proper size. (However, remove the husks and seeds of chestnuts and dates.)
- 3 Add black sugar, sesame oil, cinnamon powder and a little bit of salt into the previously soaked White Rice and mix them properly.
- 4 Put all the ingredients including 3 into the inner pot, and then stir all evenly after pouring water into the pot until the level 4.
- 5 Close the lid, turn the handle to high pressure mode, press Menu button and select [HIGH PRESSURE STEAM]. Then set the cooking time and press Cooking with [HIGH Pressure Cook/Super Turbo] button.
- Close the lid, turn the handle to no pressure mode, press Menu button and select [NON PRESSURE STEAM]. Then set the cooking time and press [NON PRESSURE COOK] button.

# COOKING GUIDE

## NON P STEAM/HIGH P STEAM(Non P Menu/High P Menu)

### Steam Cautions

- All cups referenced are using the provided rice measuring cup. (Water: 180ml, Rice: 150g)  
 - Do not exceed the cooker's capacity. If exceeded, there is a risk of overflow and potential product damage. This may cause the overflow.

### :: Steamed Bean Curd



<b>Non P Steam time</b>	25min	<b>High P Steam time</b>	15min
-------------------------	-------	--------------------------	-------

#### Ingredients

1 set of bean curd, a little bit of salt  
 Seasoning Sauces: 1 tablespoonful of red pepper powder, 1 tablespoonful of minced garlic, a root of Welsh onion, a little bit of sesame oil, a little bit of ground sesame mixed with salt, a little bit of shredded red pepper, 3 tablespoonful of thick soy

#### Recipe

- 1 Divide bean curd set into two, slice them to 1cm thickness, and by scattering salt, remove water content.
- 2 Shred Welsh onion thin, and prepare seasoning sauce by mixing minced garlic, thick soy, red pepper powder, ground sesame mixed with salt, sesame oil and shredded red pepper.
- 3 Pour 1.5 cup of water(270ml) into My Caldron, place steaming plate, and put the sliced bean curds on top of it evenly.
- 4 Close the lid, turn the handle to high pressure mode, press Menu button and select [HIGH PRESSURE STEAM]. Then set the cooking time and press Cooking with [HIGH Pressure Cook/Super Turbo] button. Close the lid, turn the handle to no pressure mode, press Menu button and select [NON PRESSURE STEAM]. Then set the cooking time and press [NON PRESSURE COOK] button.
- 5 Once cooking is completed, take out bean curd, and apply seasoning sauce evenly on top of the bean curd.

### :: Japchae (stir-fried vegetables, and shredded meat)



<b>Non P Steam time</b>	20min	<b>High P Steam time</b>	20min
-------------------------	-------	--------------------------	-------

#### Ingredients

Cellophane 150g, paprika (green, red) each 1EA, carrot 70g, onion 70g, some spinach, enoki mushroom 70g, fishcake 70g and cooking oil 1 tablepoons

#### Recipe

- 1 After cutting paprika, onion, carrot and fish cake into thin slices, wash enoki mushroom clean, and blanch spinach in boiling water. Cut it after removing from water. (paprika and carrot: 2~3mm, onion and fish cake: 5mm)
- 2 After soaking cellophane in lukewarm water for 30 minutes, wash it with cold water (When cellophane is soaked for a long time, cellophane may be too soft or agglomerated. According to preference, soak cellophane for 10 minutes~30 minutes.)
- 3 After putting two tablespoons of cooking oil, 1/2 cup of water(90ml) and cellophane in the inner caldron, put the prepared fish cake, carrot, onion and paprika together.
- 4 Close the lid, turn the handle to high pressure mode, press Menu button and select [HIGH PRESSURE STEAM]. Then set the cooking time and press Cooking with [HIGH Pressure Cook/Super Turbo] button. Close the lid, turn the handle to no pressure mode, press Menu button and select [NON PRESSURE STEAM]. Then set the cooking time and press [NON PRESSURE COOK] button.
- 5 After cooking is completed, put spinach blanched in boiled water and mix with soy sauce, sesame oil and sugar according to your preference. Scatter sesame seeds or ground sesame mixed with salt on the seasoned Japchae.

### :: Steamed Eggplant



<b>Non P Steam time</b>	15min	<b>High P Steam time</b>	15min
-------------------------	-------	--------------------------	-------

#### Ingredients

2 pieces of eggplants  
 Seasoning Sauces: 2 tablespoonful of thick soy, 1 red pepper, 1 green chilli, 1/2 tablespoonful of red pepper powder, 1 tablespoonful of vinegar, a little bit of ground sesame mixed with salt, 1/2 pieces of Welsh onion, 4 pieces of garlic, 2 teaspoonful of sugar

#### Recipe

- 1 Chop eggplant to 4cm length, and after erecting it, make crosswise cuts.
- 2 Slice red peppers and green peppers small, mince Welsh onions and garlic, and make filling by adding thick soy, ground sesame mixed with salt, red pepper powder, sugar and vinegar.
- 3 Pour 1.5 cups of water(270ml) into My Caldron, and after adding steaming plate, place sliced eggplant on top of it evenly.
- 4 Close the lid, turn the handle to high pressure mode, press Menu button and select [HIGH PRESSURE STEAM]. Then set the cooking time and press Cooking with [HIGH Pressure Cook/Super Turbo] button. Close the lid, turn the handle to no pressure mode, press Menu button and select [NON PRESSURE STEAM]. Then set the cooking time and press [NON PRESSURE COOK] button.
- 5 Once cooking is completed, put the filling prepared on the eggplant evenly.

## NON P STEAM/HIGH P STEAM(Non P Menu/High P Menu)

### ! Steam Cautions

- All cups referenced are using the provided rice measuring cup. (Water: 180ml, Rice: 150g)
- Do not exceed the cooker's capacity. If exceeded, there is a risk of overflow and potential product damage. This may cause the overflow.

### :: Steamed Dumpling



Non P Steam time 25min High P Steam time 20min

#### Ingredients

Dumplings 10EA

#### Recipe

- 1 Pour 1.5 cups of water(270ml) into the inner pot.
- 2 Put steam pot on the inner caldron and put dumplings on the steam plate.
- 3 Close the lid, turn the handle to high pressure mode, press Menu button and select [HIGH PRESSURE STEAM]. Then set the cooking time and press Cooking with [HIGH Pressure Cook/Super Turbo] button. Close the lid, turn the handle to no pressure mode, press Menu button and select [NON PRESSURE STEAM]. Then set the cooking time and press [NON PRESSURE COOK] button.

### :: Steamed Pumpkin



Non P Steam time 15min High P Steam time 15min

#### Ingredients

1/2 pumpkin

Seasoning Sauces: 1 tablespoonful of thick soy, 1 tablespoonful of mined Welsh onion, 1/2 tablespoonful of sesame oil, 1/2 table tablespoonful of red pepper powder, a little bit of shredded red pepper, 1 teaspoonful of sugar, 1 tablespoonful of minced garlic, 1/2 tablespoonful of ground sesame mixed with salt

#### Recipe

- 1 Slice pumpkin thin.
- 2 Make seasoning sauce by mixing minced Welsh onion, minced garlic, thick soy, shredded red pepper, red pepper powder, sesame oil, ground sesame mixed with salt, and sugar.
- 3 Pour 1.5 cups of water(270ml) into My Caldron, put steaming plate in it, and after placing the sliced pumpkin on top of it, scatter seasoning sauce of 2 evenly.
- 4 Close the lid, turn the handle to high pressure mode, press Menu button and select [HIGH PRESSURE STEAM]. Then set the cooking time and press Cooking with [HIGH Pressure Cook/Super Turbo] button. Close the lid, turn the handle to no pressure mode, press Menu button and select [NON PRESSURE STEAM]. Then set the cooking time and press [NON PRESSURE COOK] button.

### :: Sweet Potato



Non P Steam time 35min High P Steam time 25min

#### Ingredients

Sweet potato 3EA

※ When sweet potato is large (more than 150g), cut it into two pieces.

#### Recipe

- 1 Pour 1.5 cups of water(270ml) in the inner pot.
- 2 Put steam pot in the inner pot and put sweet potatoes on the steam plate.
- 3 Close the lid, turn the handle to high pressure mode, press Menu button and select [HIGH PRESSURE STEAM]. Then set the cooking time and press Cooking with [HIGH Pressure Cook/Super Turbo] button. Close the lid, turn the handle to no pressure mode, press Menu button and select [NON PRESSURE STEAM]. Then set the cooking time and press [NON PRESSURE COOK] button.
- 4 When cooking is completed, be careful with the hot sweet potatoes.

#### References

- Steamed sweet potato for constipation : When you take steamed sweet potato with its skin, it is good for constipation.
- Fresh sweet potato for weak person : Sweet potato includes a lot of vitamin B, mineral and carotene. Therefore, it is food with high nutrition. Especially, when taking ground fresh sweet potato, it is good for your health. Many kinds of enzymes are included in the fluid flown out from sweet potatoes.

### :: Boiled egg



Non P Steam time 20min High P Steam time 20min

#### Ingredients

6 eggs, 2 cups of water(360ml), 1-2 drops of vinegar

#### Recipe

- 1 Put egg, water, and vinegar into the inner pot.
- 2 Close the lid, turn the handle to high pressure mode, press Menu button and select [HIGH PRESSURE STEAM]. Then set the cooking time and press Cooking with [HIGH Pressure Cook/Super Turbo] button. Close the lid, turn the handle to no pressure mode, press Menu button and select [NON PRESSURE STEAM]. Then set the cooking time and press [NON PRESSURE COOK] button.

# COOKING GUIDE

## NON P STEAM/HIGH P STEAM(Non P Menu/High P Menu)

### Steam Cautions

- All cups referenced are using the provided rice measuring cup. (Water: 180ml, Rice: 150g)  
 - Do not exceed the cooker's capacity. If exceeded, there is a risk of overflow and potential product damage. This may cause the overflow.

### :: Steamed Chestnut



**Non P Steam time** 25min **High P Steam time** 20min

#### Ingredients

Chestnut 15EA

#### Recipe

- 1 Pour 1.5 cups of water(270ml) into the inner pot.
- 2 Put steam pot on the inner caldron and put chestnuts on the steam plate (peel partial skin of chestnut to prevent bursting).
- 3 Close the lid, turn the handle to high pressure mode, press Menu button and select [HIGH PRESSURE STEAM]. Then set the cooking time and press Cooking with [HIGH Pressure Cook/Super Turbo] button. Close the lid, turn the handle to no pressure mode, press Menu button and select [NON PRESSURE STEAM]. Then set the cooking time and press [NON PRESSURE COOK] button.
- 4 When cooking is completed, be careful with the hot chestnuts.

### :: Potato



**Non P Steam time** 45min **High P Steam time** 35min

#### Ingredients

Potato (less than 200g) 3EA

#### Recipe

- 1 Pour 1.5 cups of water(270ml) into the inner pot.
- 2 Put steam pot on the inner pot and put potatoes on the steam plate.
- 3 Close the lid, turn the handle to high pressure mode, press Menu button and select [HIGH PRESSURE STEAM]. Then set the cooking time and press Cooking with [HIGH Pressure Cook/Super Turbo] button. Close the lid, turn the handle to no pressure mode, press Menu button and select [NON PRESSURE STEAM]. Then set the cooking time and press [NON PRESSURE COOK] button.
- 4 When cooking is completed, be careful with the hot potatoes.

#### How to keep potato

When potatoes are kept at normal temperature in the summer, it sprouts right away. Therefore, it is good to keep them in the refrigerator. If there is a great amount, put potatoes in a bag and keep it in a opened carton box. At this time, putting one or two apples together with potatoes will be helpful to prevent sprouting because of the effect of enzymes in apple.

### :: Sweet Corn



**Non P Steam time** 45min **High P Steam time** 35min

#### Ingredients

2 Corn

#### Recipe

- 1 Pour 1.5 cups of water(270ml) into the inner pot.
- 2 Put steam pot in the inner caldron and put corn on the steam plate.
- 3 Close the lid, turn the handle to high pressure mode, press Menu button and select [HIGH PRESSURE STEAM]. Then set the cooking time and press Cooking with [HIGH Pressure Cook/Super Turbo] button. Close the lid, turn the handle to no pressure mode, press Menu button and select [NON PRESSURE STEAM]. Then set the cooking time and press [NON PRESSURE COOK] button.
- 4 When cooking is completed, be careful with the hot corn.

### :: Rice cake gratin



**Non P Steam time** 20min **High P Steam time** 20min

#### Ingredients

50g of rice cake for teokguk, 1 boiled egg, 1 sweet potato, 40g of mozzarella cheese, 1 slice of cheddar cheese, little bit of olive oil, 1/2 cup of white sauce(75g), little bit of parsley powder  
 White sauce : Flour, 10g of butter, 100g of milk, pinch of salt and white pepper (Melt butter, add flour and stir it, add milk and boil it until it gets thick, and apply salt and white pepper for seasoning)

#### Recipe

- 1 Wash the sweet potato with peel and cut it in a circular shape.
- 2 Cut the boiled egg with a cutter, steep rice cake in warm water.
- 3 Spread olive oil on the inner pot evenly, pile up sweet potato, egg, and rice cake.
- 4 Spread white sauce on 3, put mozzarella cheese on top, cut cheddar cheese slice into 8 pieces and place it on top, and sprinkle parsley powder.
- 5 Close the lid, turn the handle to high pressure mode, press Menu button and select [HIGH PRESSURE STEAM]. Then set the cooking time and press Cooking with [HIGH Pressure Cook/Super Turbo] button. Close the lid, turn the handle to no pressure mode, press Menu button and select [NON PRESSURE STEAM]. Then set the cooking time and press [NON PRESSURE COOK] button.

## NON P STEAM/HIGH P STEAM(Non P Menu/High P Menu)

### Steam Cautions

- All cups referenced are using the provided rice measuring cup. (Water: 180ml, Rice: 150g)
- Do not exceed the cooker's capacity. If exceeded, there is a risk of overflow and potential product damage. This may cause the overflow.

### :: Steamed egg



Non P Steam time 15min

High P Steam time 15min

#### Ingredients

2 eggs, 1 cups of water or kelp water(180ml), 1 teaspoon of salted shrimps, pinch of salt, 10g of carrot, 10g of green onion

#### Recipe

- 1 Place egg and water or kelp water together and mix it well.
- 2 Finely chop carrot and the green part of green onion and it with ①.
- 3 Mince salted shrimps with little bit of water to make it soupy, mix it with ②, and season it with salt.
- 4 Close the lid, turn the handle to high pressure mode, press Menu button and select [HIGH PRESSURE STEAM]. Then set the cooking time and press Cooking with [HIGH Pressure Cook/Super Turbo] button. Close the lid, turn the handle to no pressure mode, press Menu button and select [NON PRESSURE STEAM]. Then set the cooking time and press [NON PRESSURE COOK] button.

### :: Sponge cake



Non P Steam time 50min

High P Steam time 40min

#### Ingredients

Flour (weak flour) 1cup(150g), egg 4EA, 1/2 tablespoon of butter, 1/2tablespoon of milk, vanilla perfume 10g, 1/2cup of sugar and some salt

#### Recipe

- 1 Put salt in flour and sieve it.
- 2 Separate the yolk from an egg.
- 3 Put the white of an egg in a vessel and stir it in a fixed direction. When bubbles take place, put sugar by dividing it in several times. Stir up bubbles until they don't flow down when the vessel caves over.
- 4 Continue to stir while putting the yolk in ③ little by little and put some vanilla perfume.
- 5 When ④ becomes cream, mix with flour.
- 6 Mix boiled butter with milk.
- 7 After putting butter on the bottom and the side of the inner caldron, pour cake dough into the inner caldron.
- 8 Close the lid, turn the handle to high pressure mode, press Menu button and select [HIGH PRESSURE STEAM]. Then set the cooking time and press Cooking with [HIGH Pressure Cook/Super Turbo] button. Close the lid, turn the handle to no pressure mode, press Menu button and select [NON PRESSURE STEAM]. Then set the cooking time and press [NON PRESSURE COOK] button.
- 9 Cool down the cooked sponge cake.
- 10 After pouring whipped cream in a vessel and making bubbles to be regarded to be thick, put powdered sugar (put sugar in a cutter and grind it)
- 11 Apply cream on the cooled sponge cake.
- 12 Decorate it with different kinds of prepared fruit.

### :: Shrimp ketchup fried rice



Non P Steam time 15min

High P Steam time 15min

#### Ingredients

10 medium size shrimps, 1/4 green onion, 20g of onion, 10g of carrot  
\* Ketchup sauce : 3 tablespoons of ketchup, 1 tablespoon of sugar, 1 tablespoon of starch powder, 1 tablespoon of water, pinch of salt, soy sauce, and pepper powder

#### Recipe

- 1 Remove head and internal organs of shrimps, leave one joint at tail side and tail, peel off the skin, and wash it out with salt water.
- 2 Slice green onion obliquely, and chop onion in a size that is smaller than shrimps.
- 3 Place shrimp, green onion, and onion with ketchup sauce, and mix it well.
- 4 Close the lid, turn the handle to high pressure mode, press Menu button and select [HIGH PRESSURE STEAM]. Then set the cooking time and press Cooking with [HIGH Pressure Cook/Super Turbo] button. Close the lid, turn the handle to no pressure mode, press Menu button and select [NON PRESSURE STEAM]. Then set the cooking time and press [NON PRESSURE COOK] button.
- 5 Mix it well with a spatula after multipurpose steam is completed.

# COOKING GUIDE

## NON P STEAM/HIGH P STEAM(Non P Menu/High P Menu)



### Steam Cautions

- All cups referenced are using the provided rice measuring cup. (Water: 180ml, Rice: 150g)
- Do not exceed the cooker's capacity. If exceeded, there is a risk of overflow and potential product damage. This may cause the overflow.

### :: Rice pizza



Non P Steam time 20min High P Steam time 20min

#### Ingredients

- \* Dough ingredients : 100g of rice
- \* Topping ingredients : 2 slices of ham, 2 button mushrooms, 2 tablespoons of canned corn, 1 stick of crabmeat, 40g of mozzarella cheese, 4 tablespoons of pizza sauce

#### Recipe

- 1 Peel off the skin of button mushroom and cut it in its shape, and tear a crabmeat stick into pieces.
  - 2 Cut sliced hams into squares, and remove water from the canned corn.
  - 3 Place rice on the bottom of inner pot flatly.
  - 4 Spread pizza sauce on the rice flatly using a spoon, and place topping ingredients on the top.
  - 5 Place mozzarella cheese on ④, close the lid, turn the handle to high pressure mode, press Menu button and select [HIGH PRESSURE STEAM]. Then set the cooking time and press Cooking with [HIGH Pressure Cook/Super Turbo] button.
- Close the lid, turn the handle to no pressure mode, press Menu button and select [NON PRESSURE STEAM]. Then set the cooking time and press [NON PRESSURE COOK] button.

### :: Chocolate Cake



Non P Steam time 45min High P Steam time 45min

#### Ingredients

100g of butter, 45g of sugar, 2 eggs, 55g of pancake batter, 35g of chocolate

#### Recipe

- 1 Allow the butter to come to room temperature then mix with the sugar in a large bowl.
- 2 Add eggs to the butter mixture then whisk until beaten.
- 3 Pour in the pancake batter and chocolate chips and mix.
- 4 Spread melted butter or spray nonstick cooking spray into the inside of the inner pot then pour in the cake batter and close the lid.
- 5 Turn the handle to high pressure mode, press the Menu button and select [HIGH PRESSURE STEAM], set the cooking time and press Cooking with [HIGH Pressure Cook/Super Turbo] button. Turn the handle to no pressure mode, press the Menu button and select [NON PRESSURE STEAM], set the cooking time and press [NON PRESSURE COOK] button.

### :: Tteokbokki (spicy and sweet rice cake)



Non P Steam time 20min High P Steam time 15min

#### Ingredients

200g of rice cake bars (soft), 2 pieces of fish cake, 1/4 onion, 1/4 green onion, 40g of carrot  
 \* marinade : 2 tablespoons of red pepper paste, tablespoon of starch syrup, 1 tablespoon of sugar, 1 teaspoon of sesame salt, 1 teaspoon of soy sauce, 1/3 of anchovy water(60ml)

#### Recipe

- 1 Rinse the rice cakes with cold water then cut them into bite-sized pieces.
  - 2 Cut the fish cake into 4 equal sections, julienne the carrot and onion, and slice the green onion into bite-sized pieces.
  - 3 Mix together all of the marinade ingredients in the inner pot.
  - 4 Place the rice cakes, fish cakes, and chopped vegetables into the marinade and mix well.
  - 5 Close the lid, turn the handle to high pressure mode, then press Menu button and select [HIGH PRESSURE STEAM], set the cooking time and press Cooking with [HIGH Pressure Cook/Super Turbo] button.
- Close the lid, turn the handle to no pressure mode, then press Menu button and select [NON PRESSURE STEAM]. Then set the cooking time and press [NON PRESSURE COOK] button.

## 각부 명칭(외부)



## 각부 명칭(내부)



## 부속품 안내



사용설명서 및 요리안내



주걱



계량컵

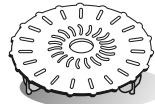

찜판(별매품)

\* 쿠쿠콜이나 전문점에서 구매가능합니다.



청소용 핀

(실물은 본체바닥면에 부착되어 있습니다.)

# 기능 조작부의 이름과 역할 / 기능 표시부의 이상점검 기능

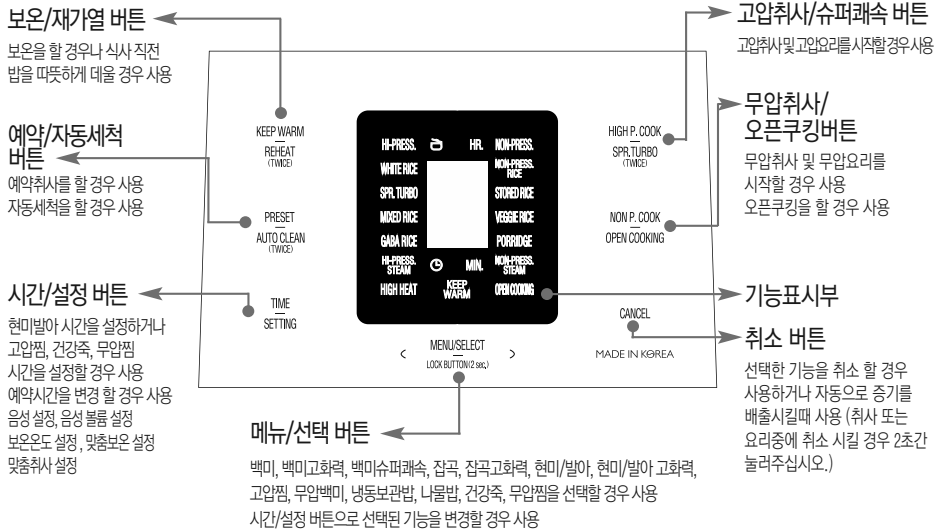

- ※ 전원플러그를 꽂고 아무 동작을 하지 않은 경우, 그림과 같이 화면상태가 나타날 때가 대기 상태입니다. (대기 상태 화면의 메뉴, 음성 유무는 사용자의 설정에 따라 다릅니다.)
- ※ 기능 조작 시 취소 버튼을 누르면 대기 상태로 전환됩니다.
- ※ 버튼은 부저음이 날 때까지 확실하게 눌러 주시고 본 명판의 디자인은 실물과 다를 수 있습니다.
- ※ 대기 상태에서 1분 경과 시 절전 모드로 전환됩니다. (뚜껑결합손잡이 불빛 소등됨)
- ▶ 절전모드 해제 방법 : 버튼을 누르거나, 뚜껑결합손잡이를 돌리거나, 뚜껑을 여닫으면 절전모드가 해제됩니다



## 기능 표시부의 이상점검 기능

사용방법이 올바르지 않거나 제품에 이상이 생겼을 때 아래와 같은 표시가 나타나 경보를 하여 줍니다. 정상적인 사용 조건에서나 혹은 조치 이후에도 지속적으로 표시가 나타날 경우에는 고객센터실로 문의하십시오.

- |  |   |  |   |
|--|---|--|---|
|  | 내물이 없을 때 나타납니다.   |  | 스마트 잠금 장치에 이상이 있을 때 나타납니다. 고객센터실로 문의하십시오.   |
|  | 스마트 잠금 장치에 이상이 있을 때 나타납니다. 취사가 완료될 때까지 뚜껑을 열지 마세요. 보온 및 대기 상태에서 뚜껑을 열고자 할 경우 전원을 차단하고 뚜껑을 열어주세요. 고객센터실로 문의 하십시오.    |  | 온도 감지기에 이상이 있을 때 나타납니다. (‘E_’ 표시, ‘E.P’ 표시, ‘E_’ 표시가 깜빡거립니다.) 고객센터실로 문의하십시오.  |
|  | 뚜껑 결합 손잡이를 정확한 압력모드로 돌리지 않은 상태에서 취사 또는 보온/재가열, 예약/자동세척, 메뉴/선택 버튼을 눌렀을 때 나타납니다. 손잡이를 “고압” 또는 “무압” 방향으로 확실하게 돌려 주십시오. |  | 마이크 외부 메모리에 이상이 있을때 나타납니다. 고객센터실로 문의하십시오.   |
|  | 물만 계속 끓일 경우나 제품이상 발생시 나타납니다. 고객센터실로 문의하십시오.   |  | 고압취사 완료 후 보온 상태에서 한번도 뚜껑 결합 손잡이를 “무압” 방향으로 하지않고, 대기 상태가 된 후 재차 취사 또는 예약/자동세척 버튼을 눌렀을 때 나타납니다. 뚜껑 체결 감지장치의 동작 확인 가능합니다. 뚜껑 결합 손잡이를 “무압” 쪽으로 한 후 다시 “고압” 방향으로 돌려 주시면 됩니다. 그래도 문제가 계속 해결되지 않으면 고객센터실로 문의하여 주십시오. |
|  | 환경센서에 이상이 있을때 나타납니다. 고객센터실로 문의하십시오.   |  | 마이크 내부 메모리에 이상이 있을때 나타납니다. 고객센터실로 문의하십시오.   |



## 고압모드 선택

뚜껑결합손잡이 방향을 “고압음”으로 하주세요.

- ▶ 뚜껑 결합 손잡이의 LED가 주황색으로 점등되고, 기능표시부에 “고압”표시가 나타나면 고압모드입니다.
- ▶ 고압모드에서는 고압메뉴만 선택이 가능합니다.
- ▶ 고압메뉴 : 백미, 백미슈퍼패속, 백미고화력, 잡곡, 잡곡고화력, 현미/발아, 현미/발아고화력, 고압찜

### 1 압력모드를 무압모드에서 고압모드로 변경을 원하실 경우 뚜껑결합손잡이를 “**고압음**”에서 “**고압음**”으로 돌려주세요.

- ▶ 압력모드가 무압모드에서 고압모드로 변경이 되면 전체 고압메뉴만 3초간 점멸 후 저장된 고압메뉴가 점등합니다.
- ▶ “고압모드입니다. 고압메뉴를 선택해주세요”하는 음성이 나옵니다.
- ▶ 뚜껑결합손잡이의 램프의 불빛이 주황색으로 변경됩니다.

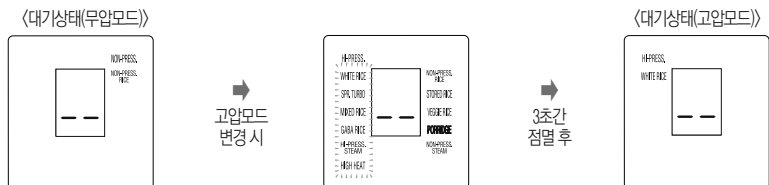

## 무압모드 선택

뚜껑결합손잡이 방향을 “**고압음**”으로 하주세요.

- ▶ 뚜껑 결합 손잡이의 LED가 흰색으로 점등되고, 기능표시부에 “무압”표시가 나타나면 무압모드입니다.
- ▶ 무압모드에서는 무압메뉴만 선택이 가능합니다.
- ▶ 무압메뉴 : 무압백미, 냉동보관밥, 니물밥, 건강죽, 무압찜

### 1 압력모드를 고압모드에서 무압모드로 변경을 원하실 경우 뚜껑결합손잡이를 “**고압음**”에서 “**고압음**”으로 돌려주세요.

- ▶ 압력모드가 고압모드에서 무압모드로 변경이 되면 전체 무압메뉴만 3초간 점멸 후 저장된 무압메뉴가 점등합니다.
- ▶ “무압모드입니다. 무압메뉴를 선택해주세요”하는 음성이 나옵니다.
- ▶ 뚜껑결합손잡이의 램프의 불빛이 흰색으로 변경됩니다.

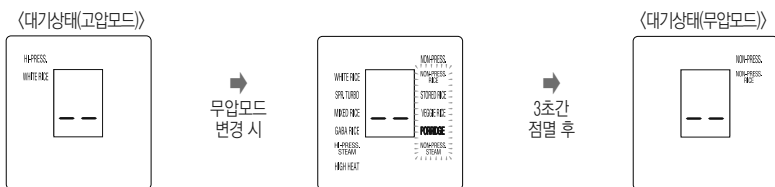

### 2 뚜껑결합손잡이의 방향을 “**고압음**” 또는 “**고압음**”으로 정확하게 하지 않을 경우 (중립위치) 메뉴선택 및 취사를 할 수 없습니다.

- ▶ 고압취사/슈퍼패속, 무압취사, 예약/자동세척 버튼 입력 시 “뚜껑결합손잡이를 원하는 압력위치로 돌려주세요”하는 음성이 나옵니다.
- ▶ 메뉴/선택 버튼 입력 시 “뚜껑결합손잡이를 고압모드 또는 무압모드로 돌린 후 메뉴를 선택해주세요.”하는 음성이 나옵니다.
- ▶ 뚜껑결합손잡이를 정확하게 돌려 고압모드 또는 무압모드를 선택해주세요.

〈뚜껑결합 손잡이 중립위치 상태〉

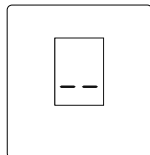

### ⚠ 주의사항

- 무압 메뉴 취사/요리시 지정된 용량으로 조리하십시오.
- 취사나 요리시에는 지정된 용량을 초과하여 요리하지 마십시오.
- 요리안내에 지정된 용량을 초과할 경우 압력추와 소프트 스틱캡으로 내용물 넘침의 원인이 됩니다.
- 반드시 지정된 설명서의 요리안내를 준수 바랍니다.

# 취사는 이렇게 하십시오

1

## 뚜껑결합손잡이로 원하는 압력모드를 선택합니다.

- 분리형 커버가 장착되어 있는지 확인하여 주십시오.
- 취사 전 압력추를 수평으로 맞추어 주십시오.
- 정확한 압력모드가 선택되지 않으면 메뉴를 선택할 수 없습니다.
- 뚜껑결합손잡이가 고압모드일 경우 고압메뉴만 선택되고 무압메뉴만 선택이 됩니다.

(고압모드)

- 메뉴/선택 버튼을 누를 때마다 백미 → 백미고화력 → 백미슈퍼패스 → 잡곡 → 잡곡고화력 → 현미/쌀아 → 현미/쌀아고화력 → 고압점 손으로 반복 선택됩니다.

(무압모드)

- 메뉴/선택 버튼을 누를 때마다 무압백미 → 냉동보관밥 → 나물밥 → 건강죽 → 무압점 손으로 반복 선택됩니다.
- 백미, 백미고화력, 잡곡, 잡곡고화력, 현미/쌀아, 현미/쌀아고화력, 무압백미는 한번 취사가 완료되고 나면 메뉴가 기억되므로 동일 메뉴를 연속 사용할 경우는 메뉴 선택을 하지 않아도 됩니다.

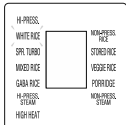

예) 백미를 선택 할 경우 → "백미" 라는 음성이 나옵니다.

2

## 고압취사/슈퍼패스 또는 무압취사 버튼을 눌러 취사를 시작합니다.

- 취사를 하기전에 고압메뉴의 경우 뚜껑결합손잡이를 "고압"으로 틀리고 고압취사/슈퍼패스 버튼을, 무압 메뉴의 경우 뚜껑결합손잡이를 "무압"으로 틀리고 무압취사 버튼을 눌러주세요.
- 고압메뉴를 선택 후 무압취사 버튼을 누르면 경고음과 함께 E01이 나타난 후 "고압메뉴입니다. 고압취사 버튼을 눌러주세요.", 무압메뉴를 선택 후 고압취사/슈퍼패스 버튼을 누르면 경고음과 함께 E01이 나타난 후 "무압메뉴입니다. 무압취사 버튼을 눌러주세요." 하는 음성이 나옵니다.
- 고압취사/슈퍼패스 버튼을 누르면 취사가 시작합니다.
- 뚜껑결합손잡이를 "고압" 또는 "무압"방향으로 하지 않고 고압취사/슈퍼패스 또는 무압취사 버튼을 누른 경우 경고음과 함께 "E01"이 나타난 후 "뚜껑결합손잡이를 원하는 압력위치로 돌려주세요." 하는 음성이 나오고 작동되지 않습니다.
- 취사 용량이나 수은, 취사 조건에 따라 실제 취사 시간은 차이가 있을 수 있습니다.

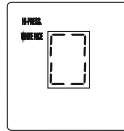

예) 고압모드에서 백미를 취사 할 경우

3

## 뜸들이기 (예 : 백미)

- 뜸 진행부더는 "뜸들이기를 시작합니다." 하는 음성과 함께 표시부에 남은 취사시간을 표시합니다. 메뉴에 따라 남은 시간은 차이가 있습니다.
- 뜸 완료 1~4분 전에 증기배출호출음(기차소리)이 나오고 "증기배출이 시작됩니다." 하는 음성과 함께 증기가 자동배출되므로 놀라거나 화상을 입지 않도록 주의하십시오.

예) 14분 남은 경우

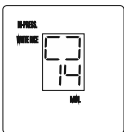

4

## 취사완료

- 취사가 끝날때 완료음(쿠~쿠~, 쿠쿠하세요, 새소리)이 울리고 "쿠쿠가 맛있는 백미밥을 완성하였습니다. 밥을 잘 저어주세요" 하는 음성과 함께 보은 기능을 시작합니다.
- 보은을 원하지 않을 경우 취소 버튼을 눌러 보은을 취소하여 주십시오.
- 취사가 끝나면 즉시 밥을 골고루 잘 섞어 주십시오. 식지 않고 그냥두면 밥이 굳고 변색되어 냄새가 발생합니다.
- 뚜껑 결합 손잡이가 잘 돌아가지 않는 경우는 압력추를 쫓힌 다음 내부 증기를 완전히 빼낸 후 뚜껑 결합 손잡이를 돌려주십시오.
- 취사중에는 취소 버튼을 누르지 마십시오. 취사가 취소됩니다.

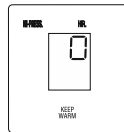

## 메뉴별 취사시간

구분	메뉴	백미 (기본메뉴)	백미고화력	백미슈퍼패스	잡곡	잡곡고화력	현미/쌀아	현미/쌀아 고화력	무압백미	나물밥	냉동 보관밥	건강죽 (원죽)	건강죽 (물은죽)	무압점	고압점	자동세척
취사량		1인분~10인분	1인분~10인분	1인분~4인분	1인분~8인분	1인분~8인분	1인분~6인분	1인분~6인분	1인분~6인분	1인분~6인분	1인분~6인분	1컵~2컵	0.5컵~1컵	메뉴별 상세 요리안내		백미물은금 2까지
취사시간		약24분~약30분	약25분~약42분	약15분~약21분	약46분~약50분	약47분~약62분	약53분~약66분	약55분~약71분	약41분~약51분	약43분~약53분	약23분~약32분	약45분~약60분	약50분~약60분	참조하여 주십시오.		약24분

※ 고압점, 무압점 등의 요리 후 취사하게 되면 냄새가 배어 들 수도 있습니다.

(59쪽을 참조하여 자동살균세척 기능을 사용하여 세척해 주십시오.)

※ 메뉴별 취사 시간은 전압, 물량, 수은 등 사용환경에 따라 다소 차이가 날 수 있습니다.

# 취사/자동세척은 이렇게 하십시오

## 취사메뉴 사용법

백미	백미를 차지게 취사할 때 사용합니다	잡곡	백미에 곡류를 섞어서 취사할 경우 사용합니다.
현미/발아	현미밥을 드시거나, 현미를 발아시켜 발아현미밥을 드시고자 할 때 사용합니다.	냉동보관밥	밥을 냉동으로 보관하여 드시고자 할 때 사용합니다.
건강죽	수동으로 건강죽 시간을 설정하여 끓이는 기능입니다.	나물밥	백미에 나물을 섞어서 취사할 때 사용합니다.
고압찜, 무압찜	수동으로 찜 시간을 설정하여 고압(1.8기압) 및 무압(1기압)에서 요리합니다.	무압백미	찰기없이 부드러운 밥을 드시고자 할 때 사용합니다.
자동세척 (자동살균세척)	취사·보온 또는 요리후 배어든 냄새를 세척 할 때 사용합니다.	고화력 (백미,잡곡,현미,발아)	일반취사와 차별되는 구수하고, 차진밥을 드시고자 할 때 사용합니다. (멜라노이징 현상이 발생할 수 있습니다.)
백미 슈퍼패속	<ul style="list-style-type: none"> <li>백미슈퍼패속 취사 시 일반 백미 메뉴보다 밥짓는 시간이 단축됩니다.</li> <li>백미슈퍼패속 진입방법1: 백미 메뉴를 선택한 후 고압취사/슈퍼패속 버튼을 2회 눌러 주십시오. 진입방법2: 백미슈퍼패속 메뉴를 선택한 후 고압취사/슈퍼패속 버튼을 눌러 주십시오. (백미슈퍼패속 1인분 기준 약 15분 정도 걸림)</li> <li>백미슈퍼패속 메뉴 1인분 취사 시, 백미1인분 물량보다 50cc 적게 넣어 주십시오.</li> <li>백미슈퍼패속 취사는 정상 취사보다 밥 상태가 좋지 않으므로 4인분 이하에서만 사용하여 주십시오.</li> <li>취사전 쌀을 20분 정도 불린 다음 백미슈퍼패속으로 취사하시면 밥맛이 더욱 좋아집니다</li> </ul>		

※ 백미슈퍼패속 및 저인분을 취사할 경우 물받이에 있는 물이 많을 수 있으므로 취사 후 물을 버려 주십시오.

## 자동세척은 이렇게 하십시오.

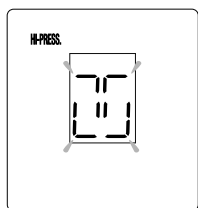

예) 고압모드 시 자동세척

내출에 표시된 자동세척 물ぬ금까지 물을 붓고, 뚜껑을 덮어 뚜껑 결합 손잡이를 "고압" 또는 "무압" 쪽으로 돌려 주십시오.

방법. 대기상태에서 예약/자동세척 버튼을 2회 눌러 자동세척을 선택한 후 고압모드에서는 고압취사/슈퍼패속 버튼을, 무압모드에서는 무압취사 버튼을 눌러 주십시오.

※ 자동세척을 정기적으로 하시면 2중모션 벨브를 청결히 유지할 수 있습니다.

## 멜라노이징(미세 밥 눌음) 현상

이 압력밥솥은 밥의 밀면에 얇은 누런 빛깔이 나타나는데, 이는 밥이 잔여수분을 밥 내부로 흡수시켜 밥 특유의 구수한 향기와 맛을 내는 멜라노이징 현상을 일으켜 맛있는 밥이 되도록 설계되어 있기 때문입니다. 특히 예약 취사와 같이 쌀알이 오랜 시간 침전되면 내출 바닥에 미세전분기가 가라앉아 일반 취사보다 멜라노이징(미세 밥 눌음)현상이 심하게 나타날 수도 있습니다.

※ 백미에 곡류를 섞어서 잡곡을 취사할 경우 백미만으로 취사할 때 보다 멜라노이징(미세 밥 눌음)현상이 증가할 수 있습니다.

# 오픈 쿠킹은 이렇게 하십시오

## 오픈 쿠킹이란?

무압 메뉴 취사 중 스마트 잠금장치를 해제시켜 뚜껑을 열고 재료를 투입하거나 내용물을 뒤집을 수 있는 기능입니다.

## 오픈 쿠킹 사용 방법

- 1 먼저, 무압 메뉴 취사 중 무압취사/오픈쿠킹 버튼을 눌러주세요.

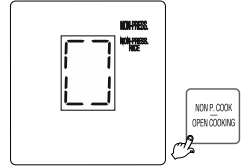

< 버튼 표시 >

- 2 그리고 스마트 잠금장치가 해제될 때까지 기다려주세요.

▶ 스마트 잠금장치는 5초 ~ 1분 후 해제됩니다.

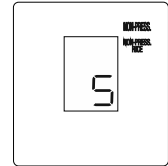

< 해제 잔여시간 표시 >

- 3 우측 그림이 표시되면, 뚜껑을 열고 재료를 투입하거나 내용물을 뒤집어주세요.

- ▶ “뚜껑을 열어주세요”하는 음성이나 나옵니다.
- ▶ 스마트 잠금장치 해제 잔여시간이 표시 중이거나 취사 중에는 뚜껑 열림 버튼을 누르지 마십시오.
- 반드시 재료 투입 표시가 나타나면 뚜껑 열림 버튼을 눌러주세요.

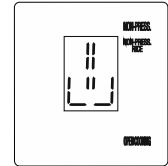

< 재료 투입 표시 >

- 4 뚜껑을 열고난 후 3분 이내에 뚜껑을 닫아주세요.

▶ 3분 이상 뚜껑이 열려 있을 경우 취사가 취소됩니다.

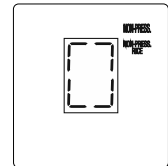

< 취사 진행 표시 >

### ⚠ 주의사항

오픈 쿠킹 시 주의 사항

- 지정된 용량을 초과하여 조리하지 마십시오.
- 지정된 용량을 초과할 경우 끓어 넘침이 발생할 수 있습니다.
- 뚜껑이 열려 있을 경우, 내솥이 가열되지 않습니다.
- 화상의 우려가 있으므로 분리형 커버를 분리하지 마십시오.
- 내솥과 분리형 커버가 제대로 장착된 상태에서 뚜껑을 닫아주세요.
- 스마트 잠금 장치가 동작 중일 때 뚜껑 열림 버튼을 누르면 파손이나 고장의 원인이 됩니다.
- 반드시 재료 투입 표시가 나타나면 뚜껑 열림 버튼을 눌러주세요.
- 만약, 제품이 정상적으로 동작되지 않을 시 고객센터로 문의 바랍니다.
- 오픈쿠킹 사용 및 무압모드 취사 완료 후 뚜껑이 열리지 않을 경우
- 우측 그림처럼 뚜껑을 눌러 스마트 잠금장치가 해제 되도록 한 후 뚜껑 열림 버튼을 눌러주세요.
- '1.' 표시가 나타날 경우 고객센터로 문의 하십시오.
- '2.' 표시가 나타날 경우 취사가 완료될 때까지 뚜껑을 열지 마세요.
- 보온 및 대기 상태에서 뚜껑을 열고자 할 경우 전원을 차단하고 뚜껑을 열어주세요. 고객센터로 문의 하십시오.



# 예약 취사는 이렇게 하십시오

## 예약 취사하는 방법 (고압메뉴를 하고 싶을 때 이렇게 하세요)

### 1 뚜껑 결합 손잡이를 “고압”위치로 돌려 핸들램프에 주황색 불이 들어오면 예약/자동세척 버튼을 누릅니다.

- ▶ 예약/자동세척 버튼을 누르면 “예약, 시간 버튼으로 예약 시간을 맞춘 후, 고압 취사 버튼을 눌러주세요.”하는 음성과 함께 표시창에 설정시간이 나타나고, 예약 표시가 깜박거립니다.
- ▶ 보온 중일 때 예약 취사를 설정 하실 경우 취소 버튼을 눌러 보온을 취소한 후 예약 시간을 설정 해주시십시오.

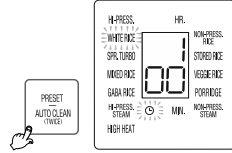

〈예약 취사 설정 모드 진입 화면〉

### 2 시간/설정 버튼을 눌러 예약 시간을 설정합니다.

- ▶ 시간/설정 버튼을 누를 때마다 예약 설정 시간이 10분씩 증가합니다. 계속 누르고 있으면 예약 설정 시간이 연속으로 증가합니다.
- ▶ 예약 시간은 1시간부터 12시간 50분까지 설정이 가능합니다.

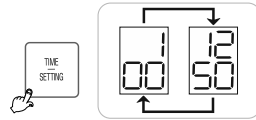

### 3 메뉴/선택 버튼을 눌러 원하는 메뉴를 선택합니다.

- ▶ 현미발아 메뉴의 경우 3H 설정시에는 예약이 되지 않습니다. 예약을 원하실 경우에는 “0H”로 설정하신 후 예약해 주십시오.
- ▶ 고압찜 메뉴의 경우 고압찜 시간 설정 후 예약이 가능합니다. 설정 시간이 60분이상일 경우, 취사 예약 시간이 2시간으로 설정됩니다.

### 4 고압취사/슈퍼패속 버튼을 누릅니다.

- ▶ 이때, “백미(설정메뉴), 맛있는 취사가 예약 되었습니다.”하는 음성과 함께 예약 취사가 진행됩니다.
- ▶ 예약 취사 진입 시 예약 표시등의 깜박거림이 멈추고 예약 시간이 1분씩 감소하면서 예약 취사가 진행됩니다.

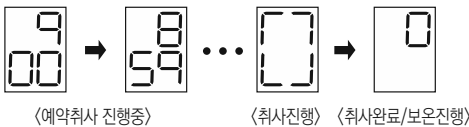

- ▶ 예약 설정된 시간은 예약 취사 완료까지 남은 시간입니다. (취사량 및 사용조건에 따라 완료 시간이 다소 차이가 날 수도 있습니다.)

# 예약 취사는 이렇게 하십시오

## 예약 취사하는 방법 (무압메뉴를 하고 싶을 때 이렇게 하세요)

### 1 뚜껑 결합 손잡이를 “ㄴ 무압” 위치로 돌려 핸들램프에 흰색 불이 들어오면 예약/자동세척 버튼을 누릅니다.

- ▶ 예약/자동세척 버튼을 누르면 “예약, 시간 버튼으로 예약 시간을 맞춘 후, 무압취사 버튼을 눌러주세요.”하는 음성과 함께 표시창에 설정시간이 나타나고, 예약 표시가 깜박거립니다.
- ▶ 보온 중일 때 예약 취사를 설정 하실 경우 취소 버튼을 눌러 보온을 취소한 후 예약 시간을 설정 해주십시오.

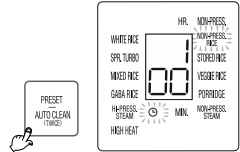

〈예약 취사 설정 모드 진입 화면〉

### 2 시간/설정 버튼을 눌러 예약 시각을 설정합니다.

- ▶ 시간/설정 버튼을 누를 때마다 예약 설정 시간이 10분씩 증가합니다. 계속 누르고 있으면 예약 설정 시간이 연속으로 증가합니다.
- ▶ 예약 시간은 1시간부터 12시간 50분까지 설정이 가능합니다.

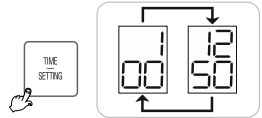

### 3 메뉴/선택 버튼을 눌러 원하는 메뉴를 선택합니다.

- ▶ 건강죽, 무압찜 메뉴의 경우 요리시간 설정 후 예약이 가능합니다. 설정 시간이 60분이상일 경우, 취사 예약 시간이 2시간으로 설정됩니다.

### 4 무압취사 버튼을 누릅니다.

- ▶ 이때, “무압백미(설정메뉴), 맛있는 취사가 예약 되었습니다.”하는 음성과 함께 예약 취사가 진행됩니다.
- ▶ 예약 취사 진입 시 예약 표시등의 깜박거림이 멈추고 예약 시간이 1분씩 감소하면서 예약 취사가 진행됩니다.

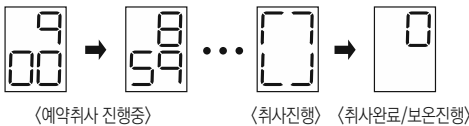

- ▶ 예약 설정된 시각은 예약 취사 완료까지 남은 시간입니다. (취사량 및 사용조건에 따라 완료 시간이 다소 차이가 날 수도 있습니다.)

## 예약 취사시 유의사항

### 1 예약 취사를 할 경우

- ▶ 쌀이 개봉된 지 오래되어 매우 말라버린 경우에는 증압이 되는 수도 있습니다.
- ▶ 예약 취사 설정시간 또는 주변 환경조건에 따라서 밥이 되거나 질어질 수 있으므로 내솔표시의 물(水)눈금 기준에서 가감하여 물량을 조절해 주십시오.
- ▶ 예약 취사 용량이 많거나 장시간 예약 취사를 설정하실 경우 밀라노이징(미세 밥 눌음)현상이 증가할 수 있습니다.

### 2 예약 시각 변경

- ▶ 예약 시각을 변경할 경우는 취소 버튼을 눌러 취소시킨 후 다시 시작하십시오.

## 产品部件名称 (外部)

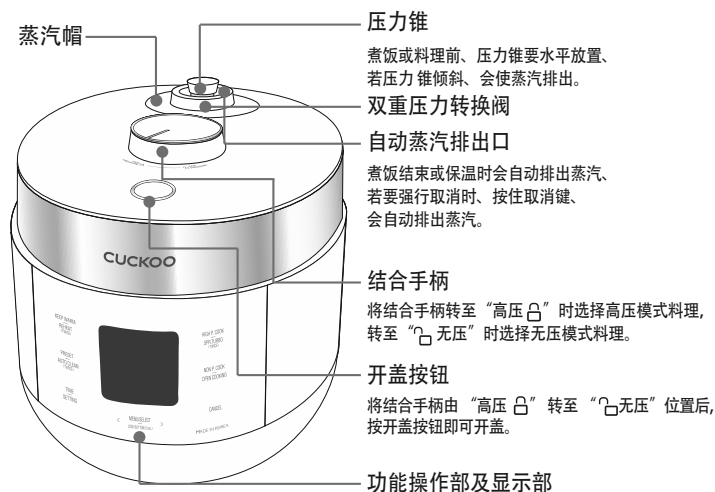

## 产品部件名称 (内部)

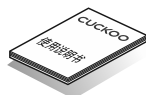
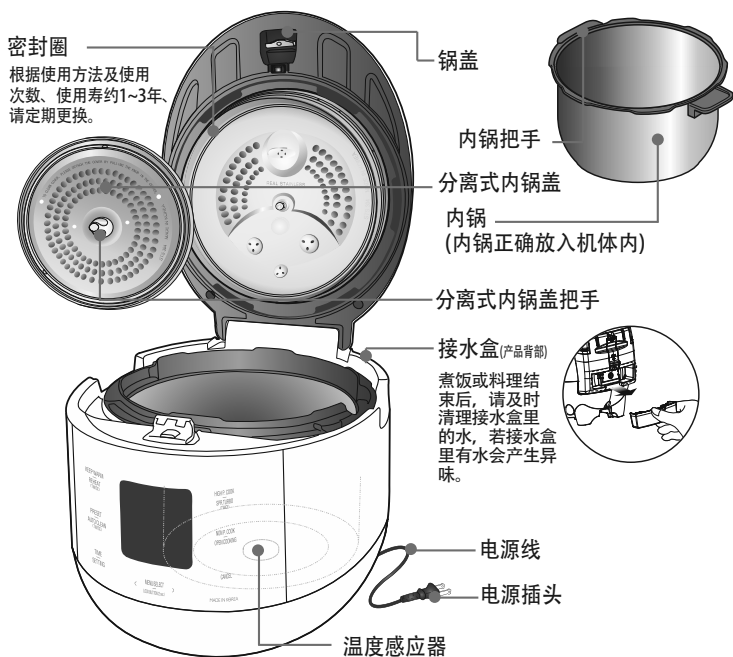

使用说明书  
料理指导



饭勺



量杯

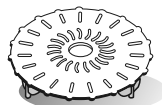

蒸盘(非附带品)  
可在福库官方网站购买



透气针  
(实物附着于产品底部)

# 功能操作部名称及作用/功能显示部异常检测功能

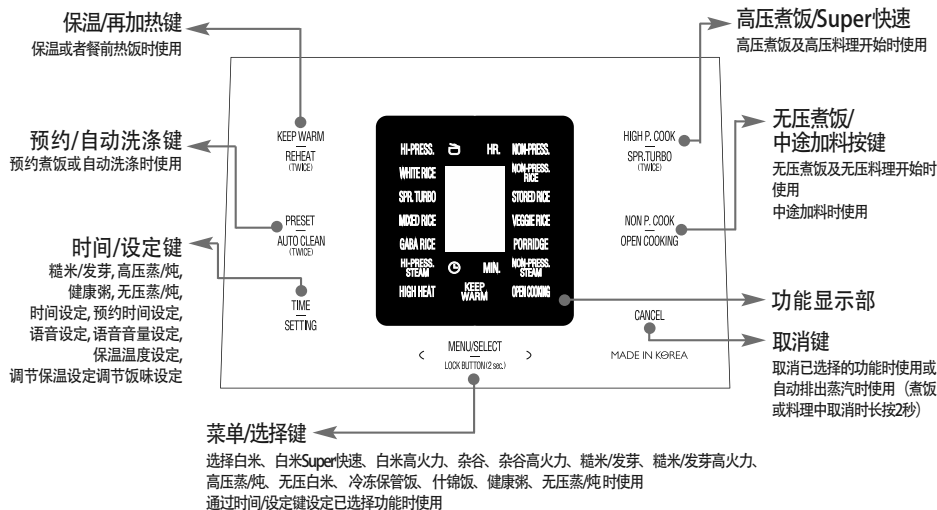

※ 接通电源后无任何操作时, 出现如图所示画面时, 为待机状态。

(待机画面下菜单、语音有无, 根据用户设定会有所差异。)

※ 功能操作时, 按取消键会返回待机状态。

※ 按键力度以听到声响为准, 本产品的标签设计可能和实物有所差异。



〈待机状态画面〉

## 功能显示部异常检测功能

使用方法错误或者产品出现异常时, 会出现以下标识给予警告。  
正常使用或者处理后, 仍不能排除故障时, 请咨询售后服务中心。

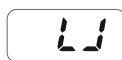

无内锅时显示。



智能锁定装置有异常时出现。  
请联系客服中心。



温度感应器异常时显示。(“E-”, “E-P”, “E-” 闪烁。)  
请咨询售后服务中心。



未正确转动锅盖结合手柄状态下, 按煮饭或保温再加热、预约、选择键时显示  
请将锅盖结合手柄转至“高压”或“无压”位置。



持续煮水或产品异常时显示。  
请咨询售后服务中心。



外存储器异常时显示,  
请咨询售后服务中心。



高压煮饭完成后, 在保温状态下, 未将锅盖结合手柄转至“无压”位置而在待机状态下再次按煮饭键, 或按预约键时显示。此功能是确认结合手柄的感应装置, 将锅盖结合手柄转至“无压”位置后, 再次转至“高压”位置即可。如仍无法解决问题, 请咨询售后服务中心。



环境感应器异常时显示,  
请咨询售后服务中心。



内存存储器异常时显示,  
请咨询售后服务中心。



# 高压模式或无压模式选择方法

## 高压模式的选择

将锅盖结合手柄方向转至“高压凸”。

- ▶ 锅盖结合手柄的LED灯亮起橘黄色，功能显示部显示“高压凸”即为高压模式。
- ▶ 高压模式下只能选择高压菜单。
- ▶ 高压菜单：白米，白米高火力，杂谷，杂谷高火力，糙米/发芽，糙米/发芽高火力，白米Super快速，高压蒸/炖

- 1 压力模式由无压模式调节为高压模式时，请将锅盖结合手柄由“无压”转至“高压凸”

压力模式从无压模式变为高压模式后，只有全部高压菜单闪烁3秒后，所保存的高压菜单开启。

- ▶ 语音提示“高压模式，请选择高压菜单”
- ▶ 锅盖结合手柄灯变为橘黄色。
- ▶ 高压模式下只能选择高压菜单功能。

〈待机状态(无压模式)〉

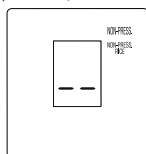

→  
高压  
模式  
变更时

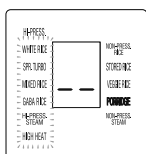

→  
闪烁  
3秒后

〈待机装填(高压模式)〉

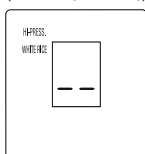

## 无压模式的选择

将锅盖结合手柄方向转至“无压”

- ▶ 锅盖结合手柄的LED等亮起白色，功能显示部显示“无压”即为无压模式。
- ▶ 无压模式下只能选择无压菜单功能。
- ▶ 无压菜单：无压白米、冷冻保管饭、什锦饭、健康粥、无压蒸/炖

- 1 压力模式下高压模式变为无压模式时，将锅盖结合手柄从“高压凸”转至“无压”

- ▶ 压力模式由高压模式变更为无压模式后，只有全部无压菜单闪烁3秒后，所保存的菜单开启。
- ▶ 语音提示“无压模式，请选择无压菜单”。
- ▶ 锅盖结合手柄的灯变为白色。
- ▶ 无压模式下只能选择无压菜单。

〈待机状态(高压模式)〉

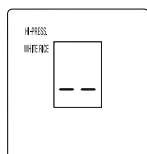

→  
无压  
模式  
变更时

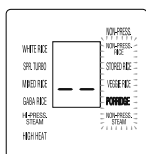

→  
闪烁  
3秒后

〈待机状态(无压模式)〉

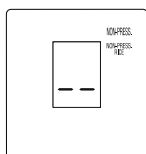

- 2 锅盖结合手柄方向转至“无压”或“高压凸”（中立位置）时，无法进行菜单选择及取煮饭。

- ▶ 按高压煮饭，无压煮饭，预约键时语音提示“请将锅盖结合手柄转至所需压力位置”。
- ▶ 按菜单选择键时语音提示“请将锅盖结合手柄转至高压模式或无压模式后再选择菜单”。
- ▶ 请将锅盖结合手柄正确转至高压模式或无压模式。

〈锅盖结合手柄中立位置状态〉

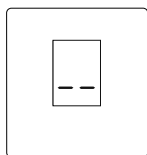

### ⚠ 注意事项

无压菜单煮饭/料理时请按指定用量进行料理。

煮饭或料理时请不要超过指定用量进行料理。

- 超过料理指南的指定用量时内容物可能会通过压力锥与蒸汽幅溢出。
- 请务必遵守说明书指定的料理指南。

# 煮饭方法

## 1 用锅盖结合手柄选择所需压力模式

- 确认是否安装了分离型内锅盖。
- 煮饭前请将压力锥放置水平。
- 未正确选择压力模式时无法选择菜单。
- 锅盖结合手柄为高压模式时只能选择高压菜单，无压模式时只能选择无压菜单。

### <高压模式>

- 每次选择键以白米→白米高火力→白米Super快速→杂谷→杂谷高火力→糙米/发芽→糙米/发芽高火力→高压蒸/炖的顺序依次变更。

### <无压模式>

- 每按一次选择键以无压白米→冷冻保管饭→什锦饭→健康粥→无压蒸/炖的顺序依次变更。
- 白米、白米高火力、杂谷、杂谷高火力、糙米/发芽、糙米/发芽高火力，无压白米煮饭完成后，菜单会自动记忆，再次做同一菜单时，无需重新选择。



例) 选择白米时 ▶ 语音提示“白米”

## 2 按高压煮饭/Super快速或无压煮饭键开始煮饭

- 煮饭前，高压菜单时将锅盖结合手柄转至“高压”位置，再按高压煮饭键，无压菜单时将锅盖结合手柄转至“无压”位置，再按无压煮饭键。
- 选择高压菜单后按无压煮饭键时警示音响起，同时显示E01后语音提示“高压菜单，请按高压煮饭键”，选择无压菜单后按高压煮饭键时警示音响起，同时显示E01后语音提示，“无压菜单，请按无压煮饭键”。
- 按煮饭键后，语音提示“开始进行白米煮饭”并开始煮饭。
- 未将锅盖结合手柄转至“高压”位置按高压煮饭/Super快速键或未将锅盖结合手柄转至“无压”位置按无压煮饭键时，警示音响起，同时显示“E01”标识后，语音提示“请将锅盖结合手柄转至所需压力位置”并无法进行煮饭。
- 根据煮饭用量、水温、煮饭条件的不同，实际煮饭完成时间可能略有差异。

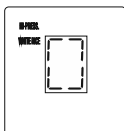

例) 在高压模式下白米煮饭时

## 3 焖饭 (例: 白米)

- 开始焖饭时，语音提示“开始焖饭”，同时显示屏显示剩余煮饭时间。
- 根据所选菜单不同，剩余时间有差异。
- 焖饭完成前1~4分钟发出蒸汽排出效果音 (火车声音) 并伴有语音提示“开始排出蒸汽”，同时自动排出蒸汽，请不要受到惊吓或烫伤。

例) 剩余14分钟时

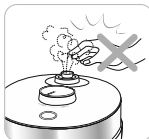
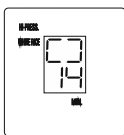

## 4 煮饭完成

- 煮饭完成时，完成音响起 (CUCKOO, 请用CUCKOO, 鸟鸣声) 语音提示“CUCKOO做好了美味的白米饭。请搅匀米饭”同时开启保温功能。
- 如不想保温，请按取消键，取消保温。
- 煮饭完成后请搅匀米饭。
- 如未搅匀，直接放置，米饭会变硬、变色、产生异味。
- 锅盖结合手柄不易转动的情况下，请推动压力锥，等内部蒸汽完全排出后再操作。
- 煮饭时请不要按取消键，煮饭会被取消。

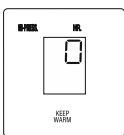

## 各菜单煮饭时间

菜单区分	白米 (基本菜单)	白米高火力	白米Super快速	杂谷	杂谷高火力	糙米/发芽	糙米/发芽高火力	无压白米	什锦饭	冷冻保管饭	健康粥 (稠粥)	健康粥 (稀粥)	高压蒸/炖 无压蒸/炖	自动洗涤
容量	1人份~10人份	1人份~10人份	1人份~4人份	1人份~8人份	1人份~8人份	1人份~6人份	1人份~6人份	1人份~6人份	1人份~6人份	1人份~6人份	1杯~2杯	0.5杯~1杯	按照菜单请参考详细料理案内	自动洗涤水位刻度
时间	约24分钟 ~约39分钟	约25分钟 ~约42分钟	约15分钟 ~约21分钟	约46分钟 ~约59分钟	约47分钟 ~约62分钟	约53分钟 ~约66分钟	约55分钟 ~约71分钟	约41分钟 ~约51分钟	约43分钟 ~约53分钟	约23分钟 ~约32分钟	约45分钟 ~约60分钟	约50分钟 ~约60分钟		约24分钟

※无压蒸/炖, 高压蒸/炖等料理后煮饭会有味道渗入。

(将密封圈与锅盖周围清理干净后, 使用自动洗涤功能清洗。)

※各菜单煮饭时间根据电压、水量、水温等使用环境的不同而略有差异。

## 煮饭菜单使用方法

白米	煮较黏的米饭时使用。	杂谷	在白米里掺入谷物煮饭时使用。
糙米/发芽	想吃糙米饭或者将糙米发芽做糙米发芽饭时使用。	冷冻保管饭	将米饭冷冻保管后食用时使用。
健康粥	可手动设置健康粥时间，有熬煮功能	什锦饭	在白米中加入什锦混合煮饭时使用。
高压蒸/炖 无压蒸/炖	手动设置蒸饭时间， 在高压(1.8气压)低压(1.0气压)下做饭	无压白米	想吃没有粘性，柔软的饭时使用。
自动洗涤 (自动杀菌洗涤)	煮饭、保温或料理结束后清除异味时使用。	高火力 (白米、杂谷、糙米发芽)	区别于普通煮饭，做香黏米饭时使用。 (可能会出现糊化现象。)
白米 Super 快速	<ul style="list-style-type: none"> <li>白米Super快速进入方法1：选择白米菜单后，请按2回 高压煮饭/Super快速 按键。</li> <li>白米Super快速进入方法2：选择 白米super快速 菜单后，请按 高压煮饭/Super快速 按键。</li> <li>白米Super快速煮饭时，比一般白米菜单煮饭时间短。(以白米Super快速1人份为基准约需要15分钟)</li> <li>白米Super快速菜单进行1人份煮饭时，水量比白米1人份少放50毫升。</li> <li>使用白米Super快速煮饭，米饭效果不如正常煮饭效果好，因此请做4人份以下饭时使用。</li> <li>煮饭前将米浸泡20分钟，然后用白米Super快速煮饭，饭味会更好。</li> </ul>		

※ 白米Super快速及煮少人份米饭时，接水盒里会有较多积水，煮饭后请清理。

※ 该款式不提供紫菜寿司，稠粥，稀粥功能。

## 自动洗涤 使用方法

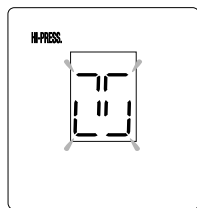

将水倒至自动洗涤水位，盖上锅盖，将锅盖结合手柄转至“高压”或“无压”位置。

方法. 待机状态下按两次预约/自动洗涤键选择自动洗涤后，在高压模式下按高压煮饭/Super快速键，在无压模式下按无压煮饭键。  
※ 定期使用自动洗涤能维持双重压力转换阀的清洁。

## 锅底米饭出现淡黄色现象

此现象为米中淀粉沉淀锅底所致，是本产品的特色，属正常现象。此淡黄色米饭的口感更加清香美味。

本产品为高温，高压下煮饭，米饭出现焦黄现象，属正常现象，请放心食用。

做杂谷饭或使用预约功能做出的米饭锅底出现焦黄现象更明显

※ 白米内掺入谷物煮杂谷饭时，与煮白米饭相比，淡黄色现象会有所增加。

# 中途加料请这样操作

## 中途加料 是?

无压菜单煮饭中解除智能锁定装置打开锅盖投入食材或翻转内锅的食材功能。

## 中途加料 使用方法

1 首先，无压力菜单煮饭中，请按无压煮饭/中途加料按键。

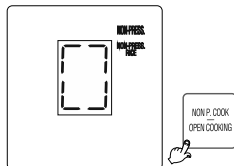

< 按键标示 >

2 然后请等待，直至智能锁定装置解除。

▶ 智能锁定装置5秒~1分钟后解除。

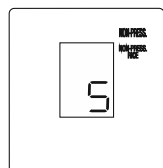

< 解除剩余时间标示 >

3 显示右侧图片后，请打开锅盖投入食材或把内锅的食材翻过来。

▶ 语音提示“请打开锅盖”。

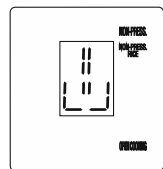

< 食材投入标示 >

4 锅盖打开后3分钟以内请关闭锅盖。

▶ 打开锅盖后超过3分钟时煮饭会被取消。

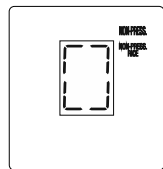

< 煮饭进行标示 >



### 注意事项 中途加料时注意事项



- 请勿超出指定的容量烹饪。
  - 超出指定容量时可能会沸腾溢出。
  - 锅盖打开时，内锅不会加热。
  - 可能会导致烫伤，请勿拆卸分离式内锅盖。
  - 内锅和分离式内锅盖安装好后盖好锅盖。
  - 智能锁定装置工作时，按开启锅盖按键可能会导致破损或故障。必须显示材料投入标志时，请按开启锅盖按键。如果，产品无法正常工作，请咨询福库客服热线。
  - 使用中途加料及完成无压模式煮饭后无法开启锅盖时如左图所示请按锅盖解除智能锁定装置后按开启锅盖按键。
  - 显示“EL1”时，请咨询售后服务中心。
  - 显示“EL2”时，煮饭完成之前请勿打开锅盖。
- 保温及待机状态下需要打开锅盖时，请切断电源后打开锅盖。  
请咨询售后服务中心

## 预约煮饭的方法(使用高压菜单时)

- 锅盖结合手柄转至“高压”位置后，关闭指示灯亮起黄色再按预约/自动洗涤键。
  - ▶未将锅盖结合手柄转至“高压”方向按预约/自动洗涤键，无法预约。
  - ▶按预约/自动洗涤键，语音提示“用时间键设定预约时间后，高压煮饭键”同时显示部显示设定时间，预约标识闪烁。
  - ▶保温中设定预约煮饭的情况，请按取消键取消保温后，设定预约时间。

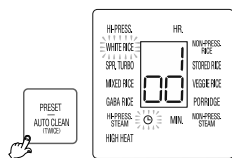

<进入预约煮饭设定模式画面>

- 按时间/设定键设定预约时间
  - ▶每按一次时间/设定键，预约设定时间增加10分钟。持续按键，预约设定时间连续增加。
  - ▶预约时间可设定为1小时~12小时50分钟。

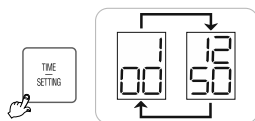

- 按菜单/选择键选择想要的菜单。
  - ▶糙米发芽菜单的情况，在3H设定时间下，无法进行预约。想要预约时请设定成“OH”后再预约。
  - ▶高压蒸/炖菜单的情况下，设定高压蒸/炖时间后，可以预约。设定时间为60分钟以上时，煮饭时间设定为2小时。

- 按压力煮饭/Super快速键。
  - ▶此时，语音提示“白米(设定菜单)，煮饭已预约。”同时进行预约煮饭。
  - ▶进入预约煮饭时，预约标识灯闪烁停止，预约时间以1分钟为单位减少，同时进行预约煮饭。

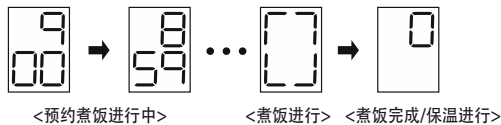

# 预约煮饭的方法

## 预约煮饭的方法(使用无压菜单时)

- 锅盖结合手柄转至“无压”位置后，关闭指示灯亮起白色再按预约/自动洗涤键。
  - ▶未将锅盖结合手柄转至“无压”方向按预约/自动洗涤键，无法预约。
  - ▶按预约/自动洗涤键，语音提示“用时间键设定预约时间后，请按无压者饭键”同时显示器显示设定时间，预约标识闪烁。
  - ▶保温中设定预约煮饭的情况，请按取消键取消保温后，设定预约时间。

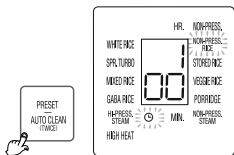

<进入预约煮饭设定模式画面>

- 按时间/设定键设定预约时间。
  - ▶每按一次时间/设定键，预约设定时间增加10分钟。持续按键，预约设定时间连续增加。
  - ▶预约时间可设定为1小时~12小时50分钟。

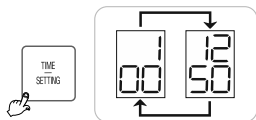

- 按菜单/选择键选择所需菜单。
  - ▶健康粥，无压蒸/炖菜单的情况下，设定蒸炖时间后，可以预约。设定时间为60分钟以上时，煮饭时间设定为2小时。

- 按无压煮饭键。
  - ▶此时，语音提示“无压白米(设定菜单)，煮饭已预约。”同时进行预约煮饭。
  - ▶进入预约煮饭时，预约标识灯闪烁停止，预约时间以1分钟为单位减少，同时进行预约煮饭。

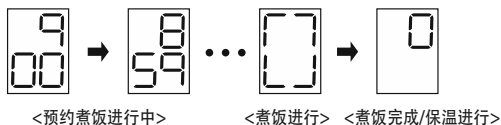

## 预约煮饭注意事项

- 预约煮饭时
  - ▶大米开封时间长较干硬时，米饭可能会夹生。
  - ▶根据预约煮饭设定时间和周边环境条件的不同，米饭可能会发硬或发软，请根据内锅水位为基准加减水量进行调整。
  - ▶预约煮饭容量过多或者设定预约煮饭时间过长时，会增加米饭底部出现淡黄色现象。
- 变更预约时间
  - ▶变更预约时间时，按取消键取消预约后重新设定。



# CUCKOO ELECTRIC RICE COOKER/WARMER LIMITED WARRANTY

KEY Company, P&K USA TRADING CORP and Cuckoo Trading Canada will repair at its option replace, without charge, your product which proves to be defective in material or workmanship under normal use, during the warranty period listed below from the date of original purchase. This warranty is good only to the original purchaser of the product during the warranty period. P&K USA TRADING CORP. covers the east and the central districts, KEY Company covers the west and the central districts, Cuckoo Trading Canada covers the whole Canada.

MODEL#	#LABOR	PARTS	WARRANTY PERIOD	HOW SERVICE IS HANDLED
CRP-ST10	1YEAR	1YEAR		The East and the Central Districts Call : 718-888-9143, 718-888-9144 Address : 5-48 46th Rd. Long Island City, NY 11101, USA
				The West and the Central Districts. Call : 323 780 8808 Address : 1137 E. 1st Street, L.A, CA 90033, USA
				Canada (TORONTO) Call : 905 707 8224 Address : #D8-7398 Yonge Street Thornhill Ontario Canada L4J 8J2
				Canada (VANCOUVER) Call : 604 540 1004 Address : 945 Lougheed Hwy Coquitlam BC Canada V3K 3T4

No other express warranty is applicable to this product. **THE DURATION OF ANY IMPLIED WARRANTIES, INCLUDING THE IMPLIED WARRANTY OF MERCHANTABILITY, IS LIMITED TO THE DURATION OF THE EXPRESS WARRANTY HEREIN. CUCKOO ELECTRONICS CO.,LTD, SHALL NOT BE LIABLE FOR THE LOSS, THE USE OF THE PRODUCT, INCONVENIENCE, LOSS OR ANY OTHER DAMAGES, DIRECT OR CONSEQUENTIAL, ARISING OUT OF THE USE OF, OR INABILITY TO USE, THIS PRODUCT OR FOR ANY BREACH OF ANY EXPRESS OR IMPLIED WARRANTY, INCLUDING THE IMPLIED WARRANTY OF MERCHANTABILITY APPLICABLE TO THIS PRODUCT.**

Some states do not allow the exclusion or limitation of incidental or consequential damages or limitations on how long an implied warranty lasts : so these limitations or exclusions may apply to you. This warranty gives you specific legal rights and you may also have other rights which vary from state to state.

### THE ABOVE WARRANTY DOES NOT APPLY IN THESE CASES:

- \* To damages problems which result from delivery or improper installation.
- \* To damages problems which result from misuse, abuse, accident, alteration, or incorrect electrical current or voltage.
- \* To serve call which do not involve defective workmanship or material and explaining the operation of the unit.

**Therefore, these costs are paid by the consumer. Customer assistance numbers :**

- To Prove warranty Coverage :**
- ▶ **Retain your Sales Receipt to prove date of purchase**
  - ▶ **Copy of your Sales Receipt must submitted at the time warranty service is provided.**

**To Obtain Product, Customer, or Service Assistance and Nearest Authorized service center, Parts Distributor or Sales Dealer:**

The East and the Central Districts  
Call : 718 888 9144  
Address : 5-48 46th Rd.  
Long Island City, NY 11101, USA

The West and the Central Districts.  
Call : 323 780 8808  
Address : 1137 E. 1st Street, L.A,  
CA 90033, USA

Canada (Toronto)  
Call : 905 707 8224  
Address : #D8-7398 Yonge Street  
Thornhill Ontario Canada  
L4J 8J2

Canada (Vancouver)  
Call : 604 540 1004  
Address : 103-4501 North Road  
Burnaby BC Canada  
V3R 4R7