

사용설명서/Operating Instructions

CRP-BH06 Fuzzy Series

1.08L(1~6Persons) / 1.08L(1~6인분)

**CUCKOO**

always new

happiness

**NO.1 CUCKOO**

CUCKOO IH PRESSURE JAR COOKER



design

love

emotion

CUCKOO ELECTRONICS CO., LTD.

# CONTENTS

Thank you very much for purchasing “CUCKOO”  
Electric Rice cooker/warmer

Read all instructions before use. Save these instructions for future reference. The Instruction will be greatly useful when you find any question or face improper operation of function.

## CONTENTS

### BEFORE USING

Important safeguards	3
Specifications	4
Safety precautions	5-8
Double Motion Packing	9
Full stainless steel Detachable Cover	10
Name of each part	11
How to clean	12-13
Function operating part	14
Error code and possible cause	14

### WHEN USING

How to set current time	15
How to set or cancel voice guide function	15
Night voice volume reduction / voice setting function	16
Before cooking rice	17
For the best taste of rice	18
How to cook	19-20
MY MODE(Cuckoo Customized Taste Function)	21-23
How to use “GABA Rice (Brown rice)”	24-25
How to cook the MULTI-COOK and NU RUNG JI	26
How to cook using fermentation bread baking	27-28
How to preset timer for cooking	29-30
How to use Simple Soft Function	30
How to use Preset Reheating Function	31-32
To keep cooked rice warm and tasty	33-35
How to use power saving / energy eye function	36
Display Lighting power saving mode	37
How to set lock buttons	37
How to use Remaining Cooking Time Display Mode	37

### BEFORE ASKING FOR SERVICE

Check before asking for service	38-40
---------------------------------	-------

### COOKING GUIDE

Cooking Guide	77-82
---------------	-------

저희 쿠쿠 압력보온밥솥을 애용해 주셔서 대단히 감사 드립니다.

이 사용설명서는 잘 보관하여 주십시오.  
사용 중에 모르는 사항이 있을 때나 기능이 제대로 발휘되지 않을 때 많은 도움이 될 것입니다.

## 목 차

### 사용하기 전에

Important safeguards	3
제품규격	4
안전상의 경고	41-44
2중모션패킹이란	45
Full 스테인리스 분리형커버	46
각 부분의 이름	47
제품 손질 방법	48-49
기능 조작부의 이름과 역할	50
기능 표시부의 이상점검 기능	50

### 사용할 때

현재시각의 설정	51
음성안내 기능의 설정과 해제	51
야간 음성볼륨 출력 기능 / 음성 설정 기능	52
취사 전 준비사항	53
맛있는 밥을 드시려면	54
취사는 이렇게 하십시오	55-56
쿠쿠 맞춤밥맛 기능은 이렇게 하십시오	57-59
현미/발아는 이렇게 하십시오	60-61
만능찜 누룽지는 이렇게 하십시오	62
발효빵은 이렇게 하십시오	63-64
예약 취사는 이렇게 하십시오	65-66
간편불림기능	66
예약 재가열은 이렇게 하십시오	67-68
밥을 맛있게 보온하려면	69-71
절전기능 / 에너지 아이 기능은 이렇게 하십시오	72
화면조명 절전기능은 이렇게 하십시오	73
버튼잠금 기능은 이렇게 하십시오	73
취사잔여 시간 표시기능은 이렇게 하십시오	73

### 고장 신고 전에

고장신고 전에 확인 하십시오	74-76
-----------------	-------

### 요리안내

요리안내	77-82
------	-------

## IMPORTANT SAFEGUARDS

1. Read all instructions before using this appliance.
2. Do not touch hot surfaces. Use handles or knobs.
3. To protect against fire, electric shock and / or injury to persons do not immerse cord, plugs, or Pressure Cooker Body in water or any other liquid.
4. Close supervision is necessary when this appliance is used by or near children.  
This appliance is not intended for use by young children or infirm persons without supervision. Young children should be supervised to ensure that they do not play with the appliance.
5. Unplug from outlet when not in use and before cleaning.  
Allow appliance to cool before putting on or taking off parts, and before cleaning the appliance.
6. Do not operate any appliance with a damaged cord or plug, after the appliance malfunctions, or has been damaged in any manner. Return the appliance to the nearest authorized service facility for examination, repair or adjustment.
7. The use of accessory attachments not recommended by the appliance manufacturer may result in fire, electric shock, and / or injury to persons.
8. If the supply cord is damaged, it must be replaced by a special cord or assembly available from the manufacturer or your service agent.
9. Do not use outdoors.
10. Do not let the cord hang over the edge of a table or counter, or touch hot surfaces.
11. Do not place on or near a hot gas, electric burner, or in a heated oven.
12. Always attach the plug to the appliance first, then plug the cord into the wall outlet. To disconnect, or SET all control to "off", then remove the plug from the wall outlet.
13. Do not use this appliance for other than its intended use.
14. Extreme caution must be used when moving an appliance containing hot oil or any hot liquids.
15. Oversized foods, metal foil packages, or utensils must not be inserted into the appliance as they are a risk of fire or electric shock.
16. A fire may occur if the appliance is covered or touching flammable material, including curtains, draperies, walls, and the like while in operation.
17. To reduce the risk of electric shock, cook only in the provided removable container.
18. This appliance cooks under pressure. Improper use may result in scalding injury.  
Before operating the unit, properly secure and close the unit. See "Operating Instructions."
19. Do not cook foods such as applesauce, cranberries, cereals, macaroni, spaghetti, or other foods.  
These foods tend to foam, froth, and sputter, and may block the pressure releasing/discharging device.
20. Before use always check the pressure releasing device for clogging.
21. Do not open the pressure cooker until the unit has cooled and internal pressure has been reduced.  
See "Operating Instructions."
22. Do not use this pressure cooker for pressure frying with oil.
23. Be sure that handles are assembled and fastened properly before each use.  
Cracked, broken or charred handles should be replaced.

## SAVE THESE INSTRUCTIONS THIS APPLIANCE IS FOR HOUSEHOLD USE ONLY

## ADDITIONAL IMPORTANT SAFEGUARDS

**WARNING :** This product generates heat and escaping steam during use. Use proper precaution to prevent risk of burns, fires, or other injury to persons, or damage to property.

1. Keep hands and face away from the Pressure Release Valve when releasing pressure.
2. Take extreme caution when opening the Lid after cooking. Severe burns can result from steam inside.
3. Never open the Lid while the unit is in operation.
4. Do not use without the inner Pot in place.
5. Do not cover the Pressure Valve with anything as an explosion may occur.
6. Do not touch the inner pot nor any heating parts, immediately after use.  
Allow the unit to cool down completely first.

## HOW TO USE EXTENSION CORD

### Note:

- A.** A short power-supply cord (or cord set) is provided to reduce the hazards from entanglement by a longer cord.  
**B.** Extension cord should be used properly.  
**C.** Extension cord usage for the rice cooker:
- (1) The correct rated voltage should be used for the rice cooker
  - (2) If the appliance is set on the ground, the extension cord should also be set on the ground.
  - (3) The cord wires and extension cord should always be arranged to prevent hazards to children.

This appliance has a polarized plug : (one blade is wider than the other).

As a safety feature, this plug will fit in a polarized outlet only one way.

If the plug does not properly fit in the outlet, turn the plug over.

If it still does not fit, contact a qualified electrician.

Please, keep this safety feature.

## SPECIFICATIONS / 제품규격

Model Name(모델명)		CRP-BH06 Fuzzy Series
Power Supply(전원)		AC120V, 60Hz
Power Consumption(소비전력)		1077W
Cooking Capacity (취사용량)	Glutinous Rice(백미)	0.18~1.08L (1~6cups)
	High Heat Glutinous Rice(고화력백미)	
	Mixed Rice(잡곡)	0.36~0.72L (2~4cups)
	High Heat Mixed Rice(고화력잡곡)	
	Soft Glutinous(Soft 백미)	
	Turbo Glutinous Rice(백미패속)	
	Turbo Mixed Rice(잡곡패속)	
	GABA Rice(현미/발아)	
	High Heat GABA Rice(고화력현미/발아)	
	Black Bean(검은콩)	
	Nutritious Rice(영양밥)	
Nu Rung Ji(누룽지)		
Nutritious Porridge(죽)	0.18~0.27L (1~1.5cups)	
Power Cord Length(전원 코드 길이)		1.0m
Pressure(사용압력)		78.4KPa(0.8kgf/cm <sup>2</sup> )
Weight(중량)		6.0kg
Dimension(치수)	Width(폭)	27.0cm
	Length(길이)	37.4cm
	Height(높이)	25.3cm

## HOW SERVICE IS HANDLED

**USA** The East and the Central Districts  
 Tel. No. 718 888 9144  
 The West and the Central Districts  
 Tel. No. 323 780 8808

**Canada** TORONTO  
 Tel. No. 905 707 8224  
 VANCOUVER  
 Tel. No. 604 540 1004

# SAFETY PRECAUTIONS



- Read the following product safety guide carefully to prevent any accidents and/or serious danger.
- 'Warning' and 'Caution' are different as follows.

**Warning**  
This means that the action it describes may result in death or severe injury.

**Caution**  
This means that the action it describes may result in injury or property damage.

**Warning**

- This sign is intended to remind and alert that something may cause problems under the certain situation.
- Please read and follow the instruction to avoid any harmful situation.

**Caution**

- Indicates a prohibition
- Indicates an instruction

**Warning**      **Do not**

**Do not cover the automatic steam outlet or pressure weight with your hand or face.**



- It can cause burns.
- Especially be careful to keep it out of children's reach.

**Please be cautious against water and chemicals.**

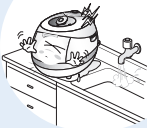

- It can cause an electric shock or fire.

**Do not use the cooker near the stove and avoid it from the sun light.**



- It can cause an electric shock, fire, deformation, malfunction, or discoloration.
- Please check the power cord and plug frequently.

**Use a single socket with the rated current above 15A.**



- Using several lines in one socket can cause overheating or fire. Please check the power cord and plug frequently
- Use an extension cord with the rated current above 15A.

**Do not alter, reassemble, disassemble or repair.**



- It can cause fire, electric shock or injury.
- For repair, contact dealer or the service center.

**Do not use damaged power cord, plug or loose socket.**



- Please check the power cord frequently for damage.
- Serious damage can cause electric shock or fire.
- If the plug is damaged, contact the dealer or a service center.

**Do not let the cooker contact any water by sprinkling water on the cooker.**

- It can cause an electric shock or fire.
- If it contacts water, please separate power cord and contact dealer and service center.



# SAFETY PRECAUTIONS



## Warning



## Do not

**Do not cover the automatic steam outlet or pressure weight with a duster, a towel, or apron, etc.**

- It can cause deformation or a breakdown.
- It can cause an explosion by pressure.



**Do not spray or put any insecticide chemicals.**

- It can cause an electric shock or fire.
- If cockroaches or any insects get inside the cooker, please call a dealer or a service center.



**Do not use pots that are not designed for the cooker.  
Do not use abnormal pot and do not use without inner pot.**

- It can cause an electric shock or fire.



**Do not put any types of needle or pins into the ventilator or any gap of the cooker.**

- Do not insert cleaning pins to other parts except to the valve hole of the pressure weight.
- It can cause an electric shock or fire.

**Do not use it without the inner pot**

- It can cause electric shock or malfunction.
- Do not pour rice or water without the inner pot
- If rice or water gets in then do not turn the product over or shank it please contact to dealer or service center.

**Do not open the top cover during heating or cooking.**

- It can cause burns.
- If you need to open the lid while cooking, keep pressing the cancel button for 2 seconds and confirm internal steam is released, completely turning the pressure weight over.

**Do not turn the Lock/Unlock Handle to "Unlock" during cooking**

- The hot steam or any hot content within the cooker can cause burns.
- After you finish the cooking do not try to open the cooker by force until the steam is completely exhausted.

**Do not place heavy things on the power cord.**

- It can cause an electric shock or fire.

**Remove external substances on plug with a clean cloth.**

- It can cause fire.  
Please check the power cord and plug frequently.

**Do not bend, tie or pull the power cord by force.**

- It can cause an electric shock or short circuit resulting in fire.  
Please check the power cord and plug frequently.



**Do not insert metal objects such as pins, wires or any other external substances in the automatic syeam exhauster or any other spot.**

- It can cause an electric shock or fire.
- Especially be careful to keep it out of reach of children.

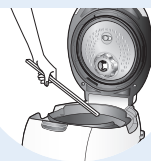

**Be careful that both the plug and power cord are not to be bit by animals, or pierced by sharp metal materials.**

- Damages by impact can cause an electric shock or fire.
- Please check the power cord and plug frequently.



**Keep the cooker out of children's reach.**

- It can cause burns, electric shock or injury.

# SAFETY PRECAUTIONS



## Warning

## Remember

Do not use on a rice chest or a shelf.

- Do not place the power cord between furniture. It can cause an electric shock resulting in fire. Please check the power cord and plug frequently.
- When using on furniture be cautious of steam release As it can cause damage, fire and and/or electric shock.

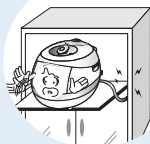

Clean any dust or external substances off from temperature sensor and inner pot.

- It can cause a system malfunction or fire.



Do not plug or pull the power cord with wet hands.

- It can cause an electric shock.

If you use cardiac pacemakers or electrical medical supporting equipment, consult a doctor before using this unit.

- When this unit is working, it can influence any electrical medical equipment.



## Warning

## Do not

Please contact dealer or service center if a strange smell or smoke has occurred.

- It can cause an electric shock.

Please pull out the plug when not in use.

- It can cause electric shocks or fire.
- Use AC 120V only.

Do not use over the maximum capacity.

- It can cause overflow or breakdown.
- Do not cook over capacity stated for cooking of chicken soup and congee.

Use product on a flat surface.

Do not use on a cushion. Please avoid using it on an unstable location prone to falling down.



Do not touch the metallic surface of the inner pot and pressure weight after cooking or warming.

- It can cause burns.
- Remaining hot steam can cause burns when you tilt the pressure weight during and after the cooking.

- It can cause malfunction or a fire. Please check the power cord and plug frequently.

Please use the cooker for original purposes.

- It can cause the malfunction or smell.

Don't use the cooker near a magnetic field.

- It can cause burns or break down.



Don't use for various purposes for inner pot.

- It can cause deformation of the inner pot.
- It can cause to spill the inner coating.

Do not drop the cooker or impact.

- It can cause malfunction.



# SAFETY PRECAUTIONS

## Warning

## Do not

Do not place on rough top or tilted top.

- It can cause burns or breakdowns.
- Be careful to install the power cord to pass without disruption.



When the exterior of inner pot is diamond shield plated.

- Use dry kitchen cleaner or sponge to clean the inner pot since rough scrub or metallic ones might cause scratch on the exterior of the plating.
- The friction of the inner pot with sink or other appliances can cause its plating's coming off. (No problem to use it)

Do not hold the cooker by the inner pot handle.

- It can cause problems and danger. There are portable handles on the bottom right and left side of the cooker. Hold the handles with both hands and move it carefully.

Please call customer service if the inner pot coating peels off.

- Oven coating may wear away after long use.
- When cleaning the inner pot, do not use tough scrubber, metallic scrubber, brush, abrasive metallic etc.



After you finish cooking, do not try to open the cooker by force until the steam is completely exhausted.

- The hot steam or any hot content within the cooker can cause burns.
- Cautiously open the top cover after cooking is done to avoid dangerous steam and burns.



## Warning

## Remember

Be cautious when steam is being released

- When the steam is released don't be surprised.
- Please keep the cooker out of reach of children.

When you pull out the power plug, don't pull the power cord. Please, safely pull out the power plug.

- If you inflict impact on power cord, it can cause an electric shock or fire.



If power fails during rice cooking, automatic steam release may work, leading to dispersion of contents.

- Cook rice with specified amounts of rice and water.
- In particular, water more than specified amount may cause overflowing of contents.
- Cook rice while soft steam cap is mounted.

Do not keep easily spoiled food warm in the product such as red bean rice, mixed food, croquette or gratin. (Except white rice)

Wipe off any excessive water on the cooker after cooking.

- It can cause odor and discoloration.
- Wipe off water that is left behind from dew.

Please clean the body and other parts after cooking.

- After cooking chicken soup or, multi cook dishes, etc., the smell may be absorbed.
- Clean the oven packing, top heater plate and inner pot every time you cook any of those.
- Use dry kitchen cleaner or sponge to clean the inner pot, since rough scrub or metallic ones are abrasive to the coating. (Refer to page 12-13)
- Depending on the using methods or user's circumstances inner pot coating might rise. Please call the customer service for those cases.



Even if power plug is unplugged, turn lid combining hand grip always to "O" (Lock) location.

- In case My Cauldron is hot or hot cooked rice is left after cooking is completed, close lid and turn lid combining hand grip to "O" (Lock) direction even after unplugging power plug. Otherwise product deformation or damage may occur by internal pressure.
- Be sure to turn lid combining hand grip to "O" (Lock) direction during cooking and heat preservation before use.



Maintain more than 30cm of distance from the product while using.

- A magnetic field can be released from electronic goods.



## Double Motion Packing



Once the Double Motion Packing locks into place, no steam escapes into the air. You can then enjoy rice that remains fresh and tasty longer than before.



**Double Motion Packing** is CUCKOO's unique and innovative patented technology that reduces the general packing's minimal but gradual steam leakage considerably. The Double Motion Packing has a two-layer structure: an airtight layer and a support layer. Thanks to the improved airtightness, **you can enjoy fresh and tasty rice longer.**

**Double Motion Packing** is a completely new packing realized by CUCKOO. Thanks to its advanced concept and technology, once the lid is closed, the Double Motion Packing starts its first process, "**Move-Airtight**," that improves airtightness by locking both the airtight layer and the support layer. When the cooking starts and the inside pressure increases, its second process, "**Move-Support**," locks up **the airtight layer** even more **and increases the freshness and full-flavor of the rice.**

Thank you for choosing our CUCKOO Double Motion Packing product. Enjoy rice that stays fresh and full of flavor for a long time





## Full stainless steel Detachable Cover

### Full stainless steel Detachable Cover

#### *Now: Stainless even on the inside!*

The full stainless-steel cover is easy to clean and helps to keep rice fresh and tasty.

CUCKOO's full-stainless cover not only facilitates cleaning but it also improves hygiene. Due to its high temperature, pressure, and steam you can enjoy rice that remains fresh and tasty longer than ever before.



#### ■ What makes the CUCKOO detachable full-stainless cover so unique?

Since a high level of technological expertise is required in order to design the fine structure of safety devices on the lid heater plate, only CUCKOO which boasts Korea's best rice cooker know-how is able to install the detachable full-stainless cover inside. In addition, despite the difficult quality of stainless steel for heat control and adjustment, CUCKOO's unique algorithm technology makes it possible to cook flavorful and tasty rice..

# NAME OF EACH PART



## Plated inner pot with titanium ion (The outside)

- Feature
1. By plating the surface with titanium the inner pot is more durable
  2. Durable against corrosion
  3. Exterior is plated with gold titanium

## Name of each part

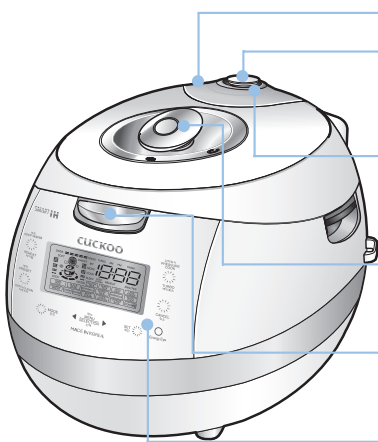

- Soft Steam Cap**
- Pressure Weight**  
Always keep it horizontal. It stabilizes steam inside of the oven. Pressure weight is twisted, it release steam.
- Automatic Steam Exhaust Outlet (Solenoid valve)**  
When finished cooking or during warming, steam is automatically released.
- Lock / Unlock Handle (Set the handle to lock when cooking or warming the rice)**  
The handle has to turn to 'Lock' for operation
- Clamp Knob**  
Turn handle to 'Unlock', and then press Clamp knob to open.
- Control Panel**

## Name of each part

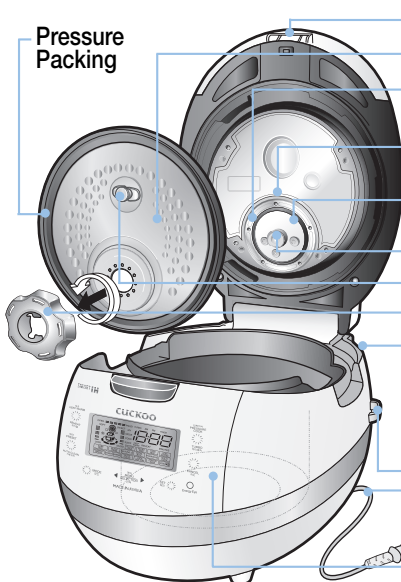

- Pressure Packing**
- Lid Assy**
- Detachable Cover**
- Control Plate Packing**
- Control Plate Packing Cover**
- Pressure Control Plate Holder Guide**
- Handle**
- Holder**
- Drain Dish**  
Empty the water out of a dew dish after cooking or keep warming. Leaving the water in the dew dish results in bad smell.
- Power Plug**
- Power Cord**
- Temperature Sensor**
- Pot Handle**
- Inner Pot (Oven)**  
Place the inner pot into the body property.
- Rice Scoop holder**

## Accessories



Manual & Cooking Guide



Rice Scoop



Rice Measuring Cup

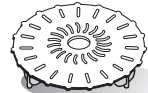

Steam Plate

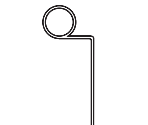
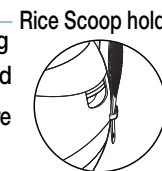
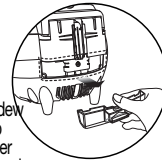

Cleaning Pin (Attached on the bottom of the unit)



# HOW TO CLEAN

- To prevent foul odor clean the detachable cover, after the rice cooker has cooled and the rice cooker is unplugged
- Body and cover should be cleaned with a dry dish towel. Do not use betel while using rice cooker, starch can remain. No effect on health.
- Do not put materials like screws into holes of detachable cover. Check the back cover and front cover.

## Detachables cover & Pressure packing

After cleaning detachable cover, put it back on the lid

Unless detachable cover is mounted, preset cooking cannot be done. (Alarm may sound while keeping warm.)

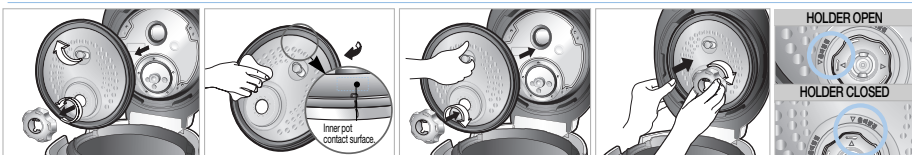

- ① Turn the holder counter clock wise, and the cover will be easily separated from the cooker and can be washed.
  - ② Wash the cover with cooking purpose neutral detergent and sponge frequently, and wipe off moisture with handkerchief.
  - ③ Please keep clean the edge of rubber packing, then the rice cooker last's longer.
  - ④ When mounting the cover, grab separate cover handle, attach it to hole, and after adjusting holder on top of packing stop tab, fix it by turning it clockwise.
  - ⑤ It is easier to attach the cover holder when the power part of the detachable cover is pressed.
- ※ As depicted in the picture, please align holder with arrow mark to open and close.

Please fir a rubber packing into the cover plate completely after washing or replacing the rubber packing.

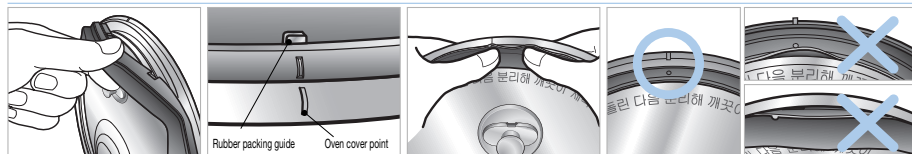

- ① To separate the rubber packing, please pull it out from the cover plate as shown in the picture.
- ② To put back the rubber packing, please fit it to each of 6 projections and holes as shown in the picture.
- ③ After fitting 6 projections to the holes, please press the rubber packing around the corner completely as shown in the picture.
- ④ Please check that the rubber packing fits into the cover plate completely. If not, steam may be released from the crack between the packing and the plate.

### CLEAN STEAM VENT AND SAFETY PACKING



Make sure to clean the clean steam vent after/before use. Do not try to pull out the clean steam vent and safety packing, clean it with care. Make sure the clean steam vent and safety packing are installed completely after/before use. If the steam vent is detached, or not attached completely, please contact customer service.

### INNER POT

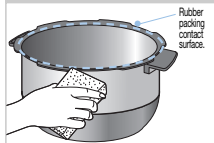

Wipe the inner, upper, and outer of the inner pot of any external substances. Do not use touch scrubber, brush, abrasive material etc.  
※ Maintaining a rubber packing cleanly will let the rice cooker last longer.

### MAIN UNIT

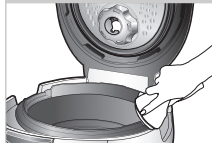

Wipe the main unit with a wet cloth that has been extracted out of all water

### INNER BODY



Make sure to clean the steam control vent before and after use.

## How to use handle

1. Handle must be located at "Lock" during Cooking.  
The lamp turning on means the top cover is closed perfectly, so you can cook.
2. After cooking, the handle must be turned from "Lock" to "Unlock", and then push clamp knob to open.  
It is hard to open when there is remaining steam in the Inner pot. At the time, twist pressure weight and let the steam out. Do not open by force.
3. Handle must be located at "Unlock" when open and close.

• If the lamp does not turn on, it would not operate "Cook" and "Preset" buttons.  
Make sure the handle is located at "Lock"





## If the valve hole of the pressure weight part is clogged, puncture it with the cleaning pin

-The valve hole of the pressure weight that allows steam to escape should be checked regularly to ensure that it is not blocked.  
If you use the valve hole of pressure weight as it is blocked, the hot steam or any hot content within the cooker can cause injury.

※ Do not use the cleaning pin for any other use except to clean the valve hole of the pressure weight.



### How to disassemble the pressure weight

- ▶ After the Lock/Unlock handle is locked (located in "Lock") turn the pressure weight counterclockwise while pulling it up, and pull it out
- ▶ Punch the clogged valve hole with the cleaning pin and reassemble it by turning it clockwise.
- ▶ When the pressure weight is properly assembled, it can freely be turned.

## How to clean the soft steam cap

Do not touch the surface of the soft cap right after cooking. You can get burned.

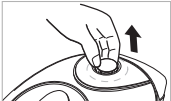

- ❶ Detach the soft steam cap like the picture.

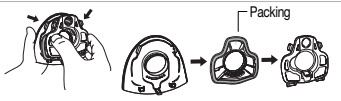

- ❷ Press the hook in the back, and follow the arrow to detach and clean. Make sure you clean frequently with a sponge or a neutral detergent.

※ When fitting the rubber packing into the plate, please make sure the packing is facing the correct direction.



- ❸ Assemble the went so that it fits into the groove perfectly.



- ❹ After you attach the soft steam cap to fit into the groove, press "A" part firmly to assemble the soft steam cap into the product.

## How to clean dew dish



- ❶ Separate dew dish

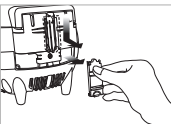

- ❷ Separate the drain ditch cap by pushing it down.



- ❸ Clean the drain ditch cap and dew dish with a neutral detergent.



- ❹ Clean the drain ditch cap with brush kit



- ❺ Securely put in the dew dish after cleaning.

## When lid does not close perfectly

Do not try to close the lid by force. It can cause problems.



1. Check to make sure the inner pot is place correctly inside the main body.
2. To close the lid turn the handle to unlock, in shown in the picture on the right.



3. If there is excess steam inside the inner pot it might be difficult to lock the handle. Twist the pressure weight and allow the excess steam to release. Then try to turn the handle again.



# FUNCTION OPERATING PART / ERROR CODE AND POSSIBLE CAUSE

## Function Operating Part

**Preset/AUTO CLEAN Button**  
Used to preset preferred cooking time (Refer to page 29-30)  
When you use automatic steam cleaning function (Refer to page 20)

**Mode button**  
This function is used to customize individual (Refer to page 21-23) cooking preference, time-setting (Refer to page 15), voice volume setting (Refer to page 16), keep warm temperature setting (Refer to page 34), and power saving mode (Refer to page 36).

**Menu / Selection button**  
This function is used to select from among Glutinous Rice, High Heat Glutinous Rice, Mixed Rice, Mega Heat Mixed Rice, Soft Glutinous, GABA Rice, High Heat GABA Rice, Black bean, Nu rung ji, Nutritious Rice, Nutritious porridge, Multi cook, Ferment Bread(Ferment), Ferment Bread(Baking), Auto clean and to modify preset time. See page 19, 20, 29. For setting selected action with mode button and setting gaba time multi-cook Bread(Ferment), Ferment Bread(Baking) time. See page 25, 26, 27, 28

**Keep Warm / Reheat button**  
Used to warm or reheat. (Refer to page 33)

**Pressure Cook / Turbo Button**  
This function is used to start cooking. (Refer to page 19)

**Cancel button**  
This function is used to cancel a selection or release remaining steam in the inner pot. (Refer to page 40) When using Power saving function. (Refer to page 36)

**Set button**  
This function is used to select a function or to button-lock function. (Refer to page 37)

- ※ If no operation is done while power cord is plugged, the system while be on standby mode as shown in the figure. (The menu on standby screen, time, voice and customized rice taste stage may differ depending on used configuration.)
- ※ If cancel button is pressed during cook, the rice cooker will go in standby mode.
- ※ Press the button until the buzzer sounds. Action may vary depending on model.

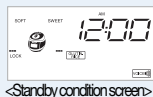

## Error Code and Possible Cause

If the product has any problems or is used inappropriately, you can follow the marks below. If error persistently shows up, in normal using conditions or after taking recommended measures, inquire with customer service.

	When the inner pot is not placed into the unit.
	Problem on temperature sensor. ("E.." mark, "E_P" mark, "E_ε" mark blink.)
	Problem on fan motor. "✳" marks blink.)
	When pressing the Pressure Cook and Timer button, while the Lock/Unlock handle is on "Unlock" Turn the Lock/Unlock handle "Lock"
	When boiling only water.
	When setting preset time longer than 13 hours Set the preset time within 13 hours. (Refer to page 29-30)
	It is appears on the display when you press Start button again, or if the cooking has finished and you've never ever turned the handle to "Unlock", it can be solved by turning handle to "Unlock" and then turn to "Lock".
	Problem on micom power.
	Problem on micom memory.
	Problem on environment sensor.
	This error messenger shows up when Pressure Cook or keeping warm/reheating button is pressed while separate cover is not mounted. Mount separate cover. Note: While keeping warm, alarm will sound and keeping warm and reheating do not work.
	This code indicates the function of checking for abnormality of power of product.

# HOW TO SET CURRENT TIME / HOW TO SET OR CANCEL VOICE GUIDE FUNCTION



## How to set current time

ex) 8:25am now

### 1 Press mode button once.

- ▶ Press mode button for more than 1sec
- ▶ "Current time mode press yes button" after setting current time with selection button
- ▶ Menu/selection button blinks and Mode, Set and Cancel buttons turn ON.
- ▶ Colon mark (:) on the sec. screen is blinking once per second.



### 2 Set 8 O'clock and 25 minute as pressing menu/selection button.

- ▶ 1 min "D" up button  
1 min down "O" button
- ▶ 10 min up or down "O", "D" keep pressing
- ▶ Careful of setting am, pm
- ▶ In case of 12:00 it is 12:00pm.



### 3 When finishing to set time you want, press "Set" button.

- ▶ Set button blinks and Mode, Menu/Selection and Cancel buttons turn ON.
- ▶ If it is over 7sec without yes button, setting time will be canceled with voice, "it is canceled due to overtime".

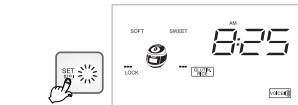

### About Lithium battery

- This product contains lithium battery for improving blackout compensation and time. Lithium battery lasts for 3 years.
- When current time is not displayed on the screen, it means the battery is exhausted. It should be replaced.

### What is blackout compensation

- This product remembers and maintains previous condition and processes. After finishing a blackout, it operates immediately.
- If blackout happens during cooking, the cooking time will be delayed depending on blackout time.
- If the rice became cold because of blackout, warming will be cancelled.

### How to set current time during keep warming mode

1. Press Cancel button to cancel keep warm and then press Mode button over 1 time to set current time.
2. After setting time, press keep warm button to re-start keep warm.

## Voice guide volume control (The function which can control volume and cancel)

To enter this function, press Mode button 2 times, Mode button needs to be pressed for over 1 second at the first time.

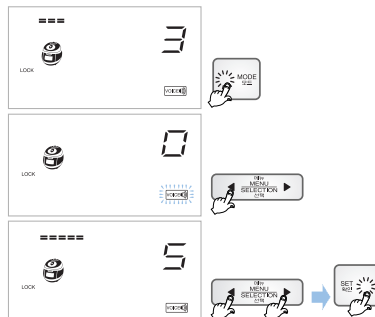

"3" sign is displayed when entered volume control mode by pressing Mode button 2 times.

If set value became "0" by pressing button, voice guide function is off.

Press button to set "5", that is the maximum volume sound. When finish setting desired volume, press Mode button to store.

- ▶ Set button blinks and Mode, Menu/Selection and Cancel buttons turn ON.
- ▶ Keep the button pressed, and the button will turn to Continuous.
- ▶ Set to desired voice volume, and press Set button.



# NIGHT VOICE VOLUME REDUCTION/ VOICE SETTING FUNCTION

## Night Voice Volume Reduction

Set the function of night voice volume reduction, the function to reduce the volume of voice during night time (10:00PM-05:59AM) on need-to-do basis. This function works only during night time.

### ► How to set night voice volume reduction

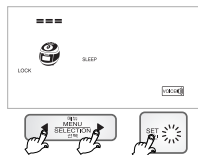

OPER. =	Zero volume
OPER. ==	20% of day time voice volume
OPER. ===	40% of day time voice volume
OPER. ====	60% of day time voice volume
OPER. =====	80% of day time voice volume

Example) 60% of day time voice volume

Night voice volumes by the setting of process progress

1. Press mode button 11 times in standby status, and you will enter Night Voice Volume Reduction mode. When pressing mode button initially, press the button for 1 second or longer to enter Night Voice Volume Reduction mode.
2. When you enter Night Voice Volume Reduction mode, a voice comes up saying "You have entered Night/Voice Volume Reduction. Select or inactivate Night Voice Volume Reduction mode with 'Menu/Selection' button and press 'Set' button."
3. Press 'Menu/Selection' button, and as process progress bar change, voice volume will change. Select desired voice volume, and press 'Set' button.
4. Once process progress bar reach full condition through adjustment of 'Menu/Selection' button, a voice will come saying "The function of Night Voice Volume Reduction is inactivate." Inactivate the function by pressing 'Set' button.
5. If 'Set' button is pressed or no button is pressed for 7 seconds after you enter Night Voice Volume Reduction mode, the function will be inactivated along with voice "As set time is elapsed, the function is inactivated", and the system will be back to standby mode.

## Voice Setting Function

This function helps you select Auto voice for either a woman or English or Chinese's voice. With this function, you can set to your desired voice.

### ► How to set voice function

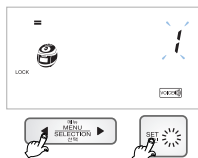

Example) When set to woman voice

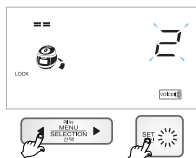

Example) When set to English voice

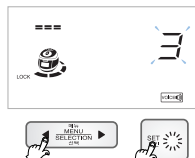

Example) When set to Chinese voice

1. Press mode button 12 times in standby status, and you will enter Voice mode. When pressing mode button initially, press the button for 1 second or longer to enter Voice mode.
2. When you enter Night mode, a voice comes up saying "You have entered Voice function. Select or inactivate Woman, English and Chinese Voice mode with 'Menu/Selection' button and press 'Set' button."
3. After setting Auto voice with 'Menu/Selection' button, Woman voice or English or Chinese, and press 'Set' button.
4. If 'Set' button is pressed or no button is pressed for 7 seconds after you enter Volume, the function will be inactivated along with voice "As set time is elapsed, the function is inactivated", and the system will be back to standby mode.



# BEFORE COOKING RICE



- 1 Clean the inner pot and wipe the water on the inner pot with dry cloth.
  - ▶ Use the soft cloth to wash the inner pot.
  - ▶ Touch scrubber can make the coating come off.
- 2 Measure the amount of rice you want to cook using the measuring cup.
  - ▶ Make the rice flat to the top of measuring cup and it is serving for 1 person. (ex: for 3 serving → 3 cups, for 6 servings → 6 cups)
- 3 Wash the rice with another container until the water becomes clear.
- 4 Put rinsed rice into the inner pot.
- 5 According to menu, adjust the water amount.



- ▶ For measuring, place the inner pot on a leveled surface and adjust the amount of water.
- ▶ The marked line of the inner pot indicates water level when putting the rice and water into inner pot together
- ▶ About water scale
  - Glutinous rice, Turbo Glutinous rice, High Heat Glutinous Rice, Black Bean, Nu rung ji and Nutritious rice : Adjust waterlevel to the water scale for 'GLUTINOUS'. Glutinous rice / High Heat Glutinous rice can be cooked to max 6 servings, Turbo Glutinous rice / Black Bean /Nu rung ji / Nutritious rice to max 4 servings.
  - Mixed Rice, Turbo Mixed rice, High Heat Mixed Rice : Adjust water level to the water scale for 'Mixed Rice'. Mixed Rice / Turbo Mixed rice / High Heat Mixed Rice / can be cooked to max 4 servings servings, Turbo Mixed Rice to max 6 servings,
  - GABA Rice, High Heat GABA Rice : Adjust water level to the water scale for 'GABA Rice'. GABA Rice / High Heat GABA Rice can be cooked to max 4 servings
  - Nutritious porridge : Adjust water level to the water scale for 'Nutritious porridge'. 'Nutritious porridge can be cooked to max 1.5 servings.
  - Soft Glutinous Rice : Adjust water level to the water scale for 'Soft GLUTINOUS'. Soft Glutinous Rice can be cooked to max 4 servings.

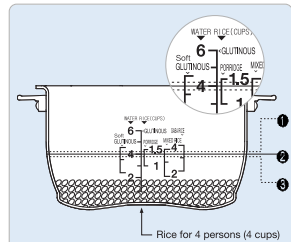

※ Cook in cereals menu, hard cereals like red-bean can be half cooked depending on the kind of cereal  
 ※Please refer to the cooking menu time for the each menu. (Refer to page 19)

## 6 Put the inner pot into the main body and close the topcover.

Please, check if detachable cover is attached

- ▶ In case detachable cover is not attached, when pressure cook/reheat button is pressed, “Eco” error could occur and cook/warm function will not work. Put the inner pot correctly.

- ▶ If there is any external substance on the temperature sensor or the bottom of the inner pot, wipe it off before putting the pot into the main unit.
- ▶ Top cover will not close if the inner pot is not placed correctly in the main body (Place the inner pot to the corresponding parts of the main body)

## 7 Connect power plug and turn the handle to “Lock”

- ▶ The lamp turning on means closed perfectly.
- ▶ If you press the cook button without setting the Lock/Unlock handle to “Lock”, the cooker will not operate. You will hear “beep beep” sound and “E01” is shown in The LCD.
- ※ If you want to select another function while cooking, push cancel button.
- ▶ If “E do” mark shows up in other instance, turn cover handle to “Open” direction, and turn it toward “Lock”. Then the cooker will work normally. (The operation of cover lock sensing device can be checked.)
- ※ **Note: This instruction is not applicable if cover handle is turned toward “Open” direction once or more after cooking was completed in previous cooking.**

- 1 When you want to cook the old rice or want the soft rice : pour more water than the measured scale
- 2 Glutinous rice for 4 persons (4cups) : set the water to scale 4 of “Glutinous”
- 3 For overcooked rice : pour less water than the measured scale





## FOR THE BEST TASTE OF RICE

### Cook tasty rice with Cuckoo pressure rice cooker

For the best taste of rice, check the following points carefully.

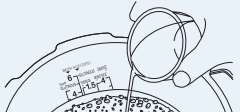
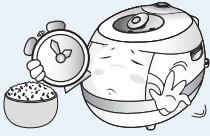
<p><b>Use the measuring cup!</b></p> <p><b>Pour the water until water level marking in the inner pot!</b></p>	<ul style="list-style-type: none"><li>• When measuring the rice, Use the measuring cup. (The amount of the rice may vary depending on the quality of the rice)</li><li>• Place the inner pot on a flat surface and adjust the water to water level in the inner pot.</li></ul>	<p>When the proportion between the amount of rice is not proper, rice can be crisp or hard.</p> 
<p><b>How to keep the rice</b></p>	<ul style="list-style-type: none"><li>• If possible, buy a small amount of rice and keep the rice some place where ventilates well and evaporation of rice moisture.</li><li>• If the rice has been unsealed for long, rice can be dry and stale. In this case, you should pour the half of water more. It's tastier.</li></ul>	<p>When rice is too dry, it can be crisp even though measuring the amount of rice is accurate.</p>
<p><b>It's better to set the preset time shortly.</b></p>	<ul style="list-style-type: none"><li>• If possible, do not use the preset time function if rice is too dry and pour more water more.</li></ul>	<ul style="list-style-type: none"><li>• If you set "Preset" over the 10 hours or "Preset" dried rice, rice can be crisp or half cooked. Even worse condition, rice can be cooked different tastes each level.</li><li>• If the preset time is longer, the melanoizing effect could be increased.</li></ul>
<p><b>It's better to set the Keep warming time shortly.</b></p>	<ul style="list-style-type: none"><li>• It's better to set the keep warming in 12 hours.</li></ul> 	<p>If rice is kept warm for a long period of time, rice color will change, and can cause odor.</p>
<p><b>Keep the product clean.</b></p>	<ul style="list-style-type: none"><li>• Clean the product often. (Especially clean the top of the cover for external substance.)</li></ul>	<p>Wipe the top cover heating part well for any rice or external substance.</p>

# HOW TO COOK



## 1 Choose menu with menu/selection button

- Select button.
- Each time "Menu" button is pressed, the selection switches in the sequential order, Glutinous Rice → High Heat Glutinous Rice → Mixed Rice → High Heat Mixed Rice → Soft Glutinous Rice → GABA Rice → High Heat GABA Rice → Black bean → Nu rung ji → Nutritious Rice → Nutritious porridge → Multi cook → Ferment Bread(Ferment) → Ferment Bread(Baking) → Auto clean.
- If the button is pressed, repeatedly, the menu switches continuously in sequential order.
- In the cases of glutinous rice, mixed rice, sushi, GABA rice, and black bean the menu remains memorized once each cooking is completed, so for continuous use of the same menu, no selection of menu is required.



ex) In case of selecting Soft Glutinous Rice  
 ▶ You can hear a voice. Soft Glutinous Rice. When cook Soft Glutinous Rice, automatic steam outlet operates while cooking.

## 2 Start cooking by pressing Pressure Cook/Turbo button.

- You must turn lid handle to lock before cooking.
- Then press the pressure Cook/Turbo button.
- Unless lid handle is nit turned to close, you get alarm with "E01", and sound "turn lid handle to lock"

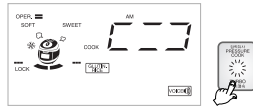

ex) In case of cooking Glutinous.

## 3 Cooking thoroughly

- The cook time remaining on the display is shown from cooking thoroughly. The cook time is different according to the menu.
- Be careful not to burn yourself from the automatic steam outlet.

ex) In case of 14minutes left

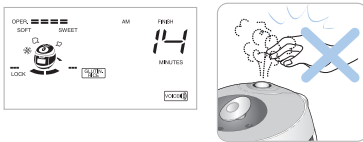

## 4 The end of cooking

- When cooking completed. Warming will start with the voice "cuckoo completed glutinous"
- When cooking ends, stir rice equally and immediately. If you don't stir rice at once and keep it stagnant, rice will go bad and smell bad.
- If the lid handle is not working well, take out the steam completely out of inner pot by turning over pressure weight.
- While cooking, do not press cancel button.



## Cooking time for each menu

Menu Class	Glutinous	Turbo Glutinous Rice	High Heat Glutinous Rice	Mixed Rice	High Heat Mixed Rice	Turbo Mixed Rice	Soft Glutinous Rice	GABA Rice	High Heat GABA Rice	Black bean	Nutritious Rice	Nu rung ji	porridge	Multi Cook	Fermentation/ Bread Baking	Automatic Sterilization (Steam Cleaning)
Cooking Capacity	1-6 servings	2-4 servings	2-6 servings	2-4 servings	2-4 servings	2-4 servings	2-4 servings	2-4 servings	2-4 servings	2-4 servings	2-4 servings	2-4 servings	1-1.5 servings	See detailed guide to cooking by the menus.		Up to water scale 2
Cooking Time	About 23 min ~ About 32 min	About 14min ~ About 21 min	About 29min ~ About 37 min	About 44min ~ About 53 min	About 46min ~ About 58 min	About 28min ~ About 34 min	About 49min ~ About 54 min	About 49min ~ About 55 min	About 50min ~ About 59 min	About 38min ~ About 44 min	About 29min ~ About 33 min	About 32min ~ About 44 min	About 69min ~ About 83min			

※ After cooking chicken soup and multi cook etc, the small may permeate into the unit, use the Unit after cleaning the rubber packing and lid part according to page 12.

※ Cooking time by menus may vary to some degree depending on the using environment of the product.



# HOW TO COOK

## How to use the cooking menu

<b>Glutinous</b>	When you want to have sticky and nutritious white rice.	<b>Soft Glutinous</b>	When you want to have a little more sticky and nutritive white rice than Glutinous rice.
<b>Mixed Rice</b>	This menu is used to cook a variation of mixed rice or brown rice.	<b>GABA Rice</b>	Used to cook germinated brown rice. This menu is used to either ferment or bake
<b>Black bean</b>	Use when cooking black soy rice.	<b>Ferment Bread (Ferment/Baking)</b>	This menu is used to either ferment or bake the bread.
<b>Nu rung ji (Scorched rice)</b>	Used to cook Nu Rung Ji (Scorched rice)	<b>Nutritious Rice</b>	Used to cook nutritious rice.
<b>Porridge</b>	For cooking porridge.	<b>Multi Cook</b>	This menu is used to cook various dishes by setting a time manually
<b>Automatic Sterilization (Steam Cleaning)</b>	This menu is used to eliminate small soaked after cooking or warming.	<b>High Heal (Glutinous/Mixed GABA Rice)</b>	Use when cooking more sticky and soothing Cooked Rice
<b>Mixed Rice Turbo</b>	<ul style="list-style-type: none"> <li>· If selected turbo mixed rice, total cooking time will be reduced. (It takes about 26minutes for cooking mixed rice for two people.)</li> <li>· Turbo mixed rice cooking lessens the quality of food, so only use for less than four people.</li> <li>· For better taste, we recommend soaking mixed rice or boiling hard beans before cooking.</li> </ul>		
<b>Turbo function for Glutinous rice</b>	<ul style="list-style-type: none"> <li>· Pressing "pressure cook/turbo" twice will switch to quick cooking "Pressure Cook/Turbo" twice will switch to quick cooking and shorten the cooking time. (It takes about 14minutes when you cook the Glutinous rice for 2 persons.)</li> <li>· Use this turbo cooking function only for cooking rice for less than 4 persons. (The condition of the rice will not be good for more than 4 persons.)</li> <li>· The turbo cooking function is allowed up to 6 persons.</li> <li>· If you soak the rice in water for about 20minutes before cooking the rice and then cook the rice in turbo cooking course, the rice will taste good.</li> </ul>		

※ After cooking in white rice turbo mode or cooking of small serving, discard water.

In case of small servings white rice turbo cooking, more water may be required than other menu.

※ Please refer to the cooking guide. (Refer to page 77-82)

## How to do Automatic Sterilization (Steam Cleaning)

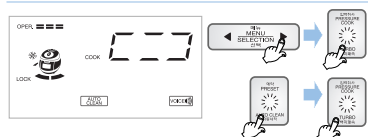

Put water until water scale 2, make sure to close and lock the cover.

Method 1. After choosing automatic cleaning menu by pressing "Menu/Selection" button, and then press "Pressure cook/turbo" button.

Method 2. After choosing automatic cleaning function by pressing "Preset/Auto clean" button twice in standby mode, press "Pressure Cook/turbo" button.

## Cook Black Bean as follows

1. Put salt into the black soy, wash clean and take out water.
2. Put cleanly washed rice into MY Cauldron, and after seasoning with sake, pour water up to white rice water graduation 2, add 1/2 measuring cup of it.
3. Place black soy on top of it, and after locking lid and selecting black soy with Menu/Selection button, press Pressure Cooking Turbo.

▶ Cook black soy only up to 6 servings.

## Melanoizing effect

The cooked rice can be light yellow at the oven, because this product is designed to improve pleasant flavor and taste. Especially, melanoizing is more serious at the "Preset cooking" than just "Cooking".

It does not mean malfunction.

※ When mixing other rice with Glutinous, Melanoizing effect could increase more than "Glutinous Rice" setting.

# MY MODE(Cuckoo Customized Taste Function)



## How to use the cooking menu

Cuckoo's patented technology based on variable circuit design. User can select the degree of "softness" and "glutinosity & tastiness" to meet a user's desire.

## My Mode Function

- ▶ Longer "SOFT" Time : rice become soft and glutinous. (selectable in 4 steps)
- ▶ Longer "SWEET" Time : rice become taste. (selectable in 4 steps) [amelanizing will occur]
- ▶ Above 2 function can be selected both or individually

## How to use "MY MODE"

To enter "Customized Rice Taste Setting Mode", select the menu in which Customized Rice Taste is supported such as glutinous rice, mixed rice, GABA, Black Bean, nu rung ji, and press the mode button for 1 second or longer. Then, you are going to enter "Customized Rice Taste Setting Mode" while hearing the voice saying "You've entered Customized Rice Taste Setting Mode. Select swelling and heating stage with Selection button, and press Set button."

### 1 "MENU" setting screen

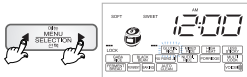

Select menu you want with menu/select button and press the set button.

### 2 "MY MODE" setting screen



To enter Customized Rice Taste Setting Mode, select desire menu and press Mode button once for 1 second or longer.

- ▶ Menu/Select button will blink, and Set, Pressure Cook and Cancel buttons will turn ON.

### 3-1 Soft time control mode



Select desired swelling time by pressing the button.

- ▶ Set button will blink, and Pressure Cook, Cancel and Menu/Select button will turn ON.

### 3-2 Sweet time control mode



Select desired heating extension time by pressing the button, and press Set button.

- ▶ Set button will blink, and Pressure Cook, Cancel and Menu/Select button will turn ON.
- ※ Note : For 16 customized rice tastes, refer to the graph for 6 rice tastes. (See page 22.)

### 4 Setting completed screen after



Set up desired customized rice taste, and press Pressure Cook.

- ▶ If you press cancel or do not press a button within 7 seconds, the function will deactivate and return to the standby mode.

## How to Use Cuckoo Customized Cooked Rice Taste

You can set the major cooked rice taste of customized cooked rice taste by entering Customized Cooked Rice Taste mode and pressing Mode button. At each press of Mode button, the major cooked taste will show up in the sequential order "Sticky Cooked Rice Taste → Soft Cooked Rice Taste → Soothing Cooked Rice Taste → Soft and Soothing Cooked Rice Taste".

### 1 "MENU" setting screen



Select a menu for which customized cooked rice taste is supported by pressing Menu/Select button.

### 2 "MY MODE" setting screen



Press Mode button once or more for 1 second or longer after selecting desire menu, and you will enter Customized Cooked Rice Taste mode.

### 3-1 Soft time control mode

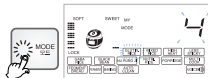

Press Mode button once, and the display will change as in the figure. At this time, Soft Cooked Rice Taste 4th Step will be selected.

### 3-2 Sweet time control mode

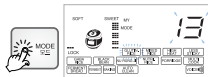

Press Mode button twice times, and the display will change as in the figure. At this time, Soothing Cooked Rice Taste 4th Step will be selected.

### 3-3 Soft and Sweet Rice Mode



Press Mode button three times, and the display will change as in the figure. At this time, Soft, Soothing Cooked Rice Taste will be selected.

### 4 Setting completed screen after



Set up desired customized rice taste, and press Pressure Cook.

- ▶ If you press cancel or do not press a button within 7 seconds, the function will deactivate and return to the standby



# MY MODE(Cuckoo Customized Taste Function)

## The display of my mode



## This is a graph of the flavors of 16 types of cuckoo custom-made rice

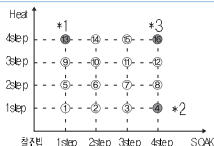

- \* The rice becomes solid and glutinous.
- \* The rice becomes soft and well-raised rice.
- \* The rice becomes soft and glutinous.
- ※ Note : Rice taste number from 1 to 16 will be displayed on the display window.

The stage mark will show up as in the figure above on the display as much as the time set during wetting swelling time and heating maintenance time, and the mark will continue to show up during cooking, reservation, keeping warm and reheating as well.

▶ Cuckoo customized taste function is applied to glutinous, mixed, GABA, Black bean, Nu Rung Ji.

※ **Set-up time is stored until the next reset. No need to set-up at every cooking.**

**During cooking, warming and preset time cooking modes, "soak" and "heat" time cannot be readjusted.**

### Cautions

1. 'MY MODE' function may influence scorching or cooking quality.
  - Ensure that cooking time is not changed, by children.
  - ※ Default settings are "SOFT" 1 step, "SWEET" 1 step.
2. 'MY MODE' function may elongate cooking time according to set-up time.
3. Scorching of rice may occur by longest "SWEET" Time.

## Cuckoo customized cooking function

While cooking you can control the heating temperature (both high and low) depending on, your preference. Initialization is set up "OPER. == == " Get step by step as the case may be.

- High step : for cooking cereals, soft-boiled rice.
- Low step : for cooking the year's crop of rice.

## How to use Cuckoo Customized cooking function

If you press the mode button 5 times, customized cooking function is set up. Select heating power by selection button. You can see all means with cuckoo customized cooking function on the display.

### ① The display Cuckoo customized cooking function

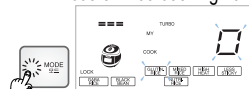

If you push the mode button 5 times, the display for customized cooking function will be set up. Initialization is like above picture.

▶ Menu/Selection button will blink, and Mode, Set and Cancel buttons will turn ON.

### ② "MY MODE" setting screen



Select menu you want with menu/select button and press the set button.

▶ Press "Set" button to set to menu.

### ②-1 High level mode

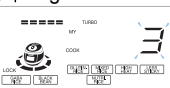

Make the screen changed by pressing menu button.

- ▶ Set button will blink, and Mode, Menu/Selection and Cancel buttons will turn ON.
- ▶ Keep pressing the button, and the menu will switch continuously.

### ②-2 Low level mode

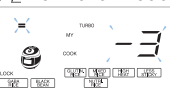

Push the menu/selection button, then the screen will be changed as above picture.

- ▶ Set button will blink, and Mode, Menu/Selection and Cancel buttons will turn ON.
- ▶ Keep pressing the button, and the menu will switch continuously.

### ③ Setting completed screen after

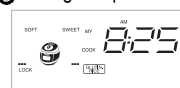

If you press the "set" button, established menu will be set up automatically. (If you press cancel or do not press a button within 7 seconds, the function will deactivate and return to the standby mode.)

1. 'Cuckoo customized cooking function' applies to Glutinous rice, High Heat Glutinous rice, Turbo Glutinous Rice, Soft Glutinous, Mixed Rice, High Heat Mixed Rice, GABA Rice, High Heat GABA Rice, Nutritious rice, Black Bean collectively.
2. Set up the step of customized cooking function to taste. The scorch can occur when cooking in high step.
3. Cook is subject to be set differently depending on the percentage of water content and the condition of rice.

# MY MODE(Cuckoo Customized Taste Function)



## How to set up the function of burning nu rung ji

- ▶ When cooking nu rung ji, please set it up for your taste with function which controls the level of burning nu rung ji.
- ▶ How to set up the enhanced burning nu rung ji (for enhanced burning nu rung ji).



1. If you push mode button 7 times at the waiting state, enhanced burning nu rung ji mode will be set up when pushing mode button more than it will be possible to set up.
2. When enhanced burning nu rung ji mode is set up, it says "after removed or selection of enhanced burning nu rung ji, push the yes button". At this time, Menu/Selection button will blink, and Mode, Set and Cancel buttons will turn ON.
3. If you push the Menu/Selection button it says "enhanced burning nu rung ji chosen press the Set button after choosing a mode you want. Press the Set button."
4. Without any button within 7 seconds or cancel button, enhanced burning nu rung ji mode will be canceled and on standby.

- ▶ How to cancel the enhanced burning nu rung ji

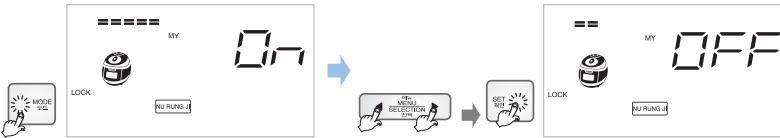

1. If you push mode button 7 times at the waiting state, enhanced burning nu rung ji mode will be set up when mode button is pushed more than 1 second, it will be possible to set up.
2. When enhanced burning nu rung ji mode is set up, it says "after removed or selection of enhanced burning nu rung ji, push the set button." At this time, Menu/Selection button will blink, and Mode, Set and Cancel buttons will turn ON.
3. If you push the menu/selection button it says "enhanced burning nu rung ji chosen press the Set button after choosing a mode you want. Press the Set button."
4. Without any button or cancel button pressed within 7 seconds, enhanced burning nu rung ji mode will be canceled and on standby.

▶ Set up this function as the situation demands because this function is on the condition of cancel for enriched scorch at the first use.



## HOW TO USE “GABA RICE(Brown rice)”

### What is Germinated Brown rice?

- ▶ Brown rice has richer nutrients than polished rice. However, brown rice is rather tough and harder to be digested. By germinating, the enzymes in the brown rice are activated, generating nutrients and become more digestible.

### Tip to buy Quality Brown Rice

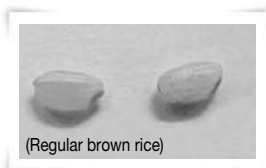
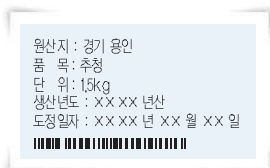

- ① Check the dates of harvest and pounding.
  - ▶ The dates should be within 1 year from harvest, 3 months from pounding.
- ② Inspect rice with your eyes.
  - Check that embryo is alive
  - Rice surface should be light yellow and glazing. Whitely stirred up surface, or darkish colored Brown rice is not suitable for germination.
  - Avoid fractured, not fully combed, or empty ear's. Empty ear's may generate odors during germination and bluish-nor combed Brown rice cannot be germinated.

### Features of Germinated Brown rice

Germinated Brown rice increases nutrients and enhances taste which is a weak point of brown rice. Germinated Brown rice also improves digestion.

- ▶ Taste will be greatly enhanced.
- ▶ Digestive and rich in nutrients.
  - Diabetic hormone is generated to improve digestion.
- ▶ Good as a health food for children or students.
  - Rich with dietary fiber.
- ▶ Germinated Brown rice has rich GABA Rice (Gamma Amino Butyric Acid)
  - GABA promotes metabolism in liver and kidneys, suppresses neutral fat, lowers blood pressure, promotes metabolism in brain cells-these effects have been proven by medical science.

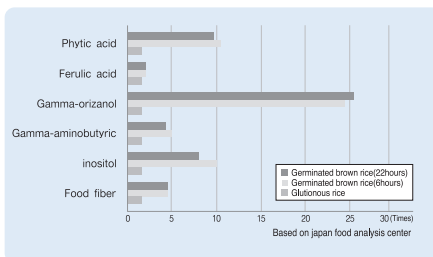

#### <Comparison of Germinated brown rice's nutrition and Glutinous rice's (6 hours) nutrition>

- ▶ Phytic acid 10.3 Times
- ▶ Ferulic acid 1.4 Times
- ▶ Gamma-orizanol 23.9 Times
- ▶ Gamma-aminobutyric 5 Times
- ▶ Inositol 10 Times
- ▶ Food fiber 4.3 Times



# HOW TO USE “GABA RICE(Brown rice)”



## Using “GABA RICE” Menu

- In Order to promote germination, soak brown rice for 16 hours in water.

### Method of Pre-germination

- ▶ Put washed brown rice in an appropriate container, pour sufficient water to soak the rice
- ▶ Pre-germination shall not exceed 16 hours. Make sure to wash rice clean with flowing water before using. “GABA RICE” menu. Be careful that hard washing may cause embryos which generate the germination to fall off.
- ▶ unique smell may be generated according to the soaking time of pre-germination
- ▶ When Pre-germination has been completed, wash the rice and put in inner pot(Over). Oven appropriate amount of water, and use “GABA RICE” menu.
- ▶ In summer or hot temperature environment odor may be generated. Reduce germination time and wash clean when cooking.

- Set the Lock/Unlock handle to “Lock”, press “Menu/Selection” button to select “GABA RICE” Menu



※ First setting time 0H(0 hours)

- ▶ When the “GABA Rice” is selected, “0H” is shown in the display.
- ▶ Set button will blink, and Mode, Menu/Selection, Cancel and Pressure Cook/Turbo buttons will turn ON.

- Press “Set” and “Menu/Selection” buttons to set time.

▶Menu/Selection button will blink, and Mode, Cancel and Pressure Cook? Turbo buttons will turn ON.

- Pressing “Menu/Selection” button increase germination time by 3hours.
  - Pressing “Menu/Selection” button decrease Germination time by 3hours.
  - “GABA Rice” time by 0,3hours, pressing “Pressure Cook/Turbo” button will start cooking immediately.
- ※ If GABA time is set “0” hours, pressing “Pressure Cook/ Turbo” button will start cooking immediately To cook without germination or cooking germinated Brown rice, set the time at “0”

- Press “Pressure Cook/Turbo” button



※ 3 more hours for germination

- ▶Pressing “Pressure Cook/Turbo” button will begin the “GABA Rice” process, after set time, cooking will begin immediately.
- ▶During “GABA Rice” mode “” indicator will show the remaining time and will be displayed in minutes with mark going around remaining time clockwise.

## Using “GABA RICE” Menu

- If smaller germ is preferred, omit pre-germination process. Select “GABA Rice” menu, set-up appropriate germination time, and start cooking (nutrient ingredients do not vary significantly by the size of germ).
- During hot seasons, longer germination time may generate odor. Reduce germination time.
- GABA Rice cooking is allowed up to 4 persons.
- Tap water can be used for germination. However, spring water is recommended. Germination may not be properly performed in hot or boiled water even after cooling.
- Germination rate, germ growth may differ by the Brown rice type, condition of period of storing, etc.  
-Germination brown rice is sprouted brown rice. Germination rate and growth may differ by the Brown rice type. The brown rice should be within 1 year from harvest, and not long since pounded.
- In GABA Rice mode, pre-set on 3H may not be possible. If you want to preset the GABA, set up '0H'.(See the page 29)
- The taste of rice could be different as depending on a kind of brown rice. Use customized taste function or control the amount of water for your taste. (Refer to page 21-23)
- Depending on the state of the surrounding environment or the condition/type of rice, the sprouts of rice may not be visible or appeared.



# HOW TO COOK THE MULTI-COOK AND NU RUNG JI

## How to use the Multi-cook and preset time

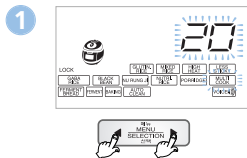

Turn the top handle to "Lock", press menu to select the Multi-cook.

- ▶ Set button will blink, and Menu/Selection, Cancel and Pressure Cooking buttons will turn ON.
- ▶ When Multi-cook is selected, the display indicates cooking time to be 20 minutes.

### 2 Press "Set", "Menu/Selection" button to set up the time.

It says after setting cooking time with selection button press the cook button.

- ▶ Menu/Selection button will blink, and Cancel and Pressure Cook/Turbo buttons will turn ON.









<p>1. </p> <p>Each time you press "Menu/Selection" button, the time increase 5 minutes. (After 90 min, time increase by 10 mins)</p> <ul style="list-style-type: none"> <li>▶ Press Menu/Selection to choose desired Menu</li> </ul>	<p>2. </p> <p>"Menu/Selection" button, the time decrease 5 minutes. (After 90min, time decreases by 10min)</p> <ul style="list-style-type: none"> <li>▶ Press Menu/Selection to choose desired Menu</li> </ul>	<p>3. Available setting time is 10-120 minutes. (Please refer to cooking guide for time setting of each menu.)</p>	<p>4. </p> <p>If you press the yes button after choosing time you want, says "press cook or tiner button"</p>
--	--	--	---



Press "Pressure Cook/Turbo" button.

- ▶ Pressure Cook button will blink, and Menu/Selection and Cancel buttons will turn ON. Press the Pressure Cook/Turbo button and Multi-cook will start. If the Multi-cook starts, the display shows the 'cooking mark' and remaining minutes.

### 4 Use the preset time of Multi-cook as following instruction.

<p>1. Check the present time.</p>	<p>2. Turn the Lock/Unlock handle to "Lock" and press the "Preset/Auto clean" button.</p> 	<p>3. Press the Menu/Selection to preset time. Then press the Set button.</p>  	<p>4. Press the Menu/Selection button to select the Multi-cook. Then press the Set button.</p>  	<p>5. Set up the cooking time for pressing menu/selection button.</p> 	<p>6. Press the "Set" button. Then press pressure cook/Turbo button.</p>  
-----------------------------------	---	---	--	---	---

## How to make Nu rung ji

1. Turn the Lock/Unlock handle to "Lock" and press menu/selection the "Nu Rung Ji," Refer to page 23
2. Press the "Pressure Cook/Turbo" button to start cooking.
3. When cooking is completed, scoop pit the boiled rice. The "Nu Rung Ji" on the jar bottom can be prepared for your taste (e.g. scorched rice tea)
  - ▶ Nu Rung Ji" can be prepared for up to 4 people.
  - ▶ For "Nu Rung Ji" cooking, set the water volume at "Glutinous" level.
  - ▶ Do not wash rice too much.
  - ▶ If you want enhanced burning nu rung ji, cook after soaking rice in water for 30 minutes.

# HOW TO COOK USING FERMENTATION/ BREAD BAKING



## Using Fermentation

- 1 Turn the top handle to “Lock”, press menu to select the “Ferment”.
  - ▶ Set button will blink, and Menu/Selection, Cancel and Pressure Cooking buttons will turn ON.
  - ▶ When the Fermenting Menu is selected, the display indicates cooking time to be 40 minutes.
- 2 Press “Set” button and “Menu/Selection” button to set fermentation time
  - ▶ Available setting time is 5~120 minutes.  
(From 90 minutes or more onward, the fermentation time increases or decreases by 10 minutes)
- 3 Press “Pressure Cook/Turbo” button
  - ▶ Press “Pressure Cook/Turb” button will begin the “Ferment” process, after which cooking will begin immediately. During “Ferment” mode, indicator will show the remaining time.
- 4 When first ferment is completed, press softly dough for remove gas and repeat process 2-3 for second ferment
  - ▶ After second ferment, open the lid and make sure dough size is 1.5 to 2 larger.

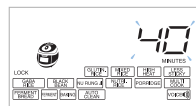

## Using Bread Baking

- 1 Press “Menu/Selection” button to select the “Bread Baking” mode.
  - ▶ When selecting “Bread baking”, the display indicate cooking time to be 40 minutes.
- 2 Press “Set” button and “Menu/Selection” button to set baking time.
  - ▶ Available setting time is 1~80 minutes.
  - ▶ Set the baking time depending on the fermentation state and the capacity of the dough.
- 3 Press “Pressure Cook/Turbo” button
  - ▶ Press “Pressure Cook/Turb” button to begin the “Bread Baking” process, after which cooking will begin immediately.  
During “Bread Baking” mode, indicator will show the remaining time.

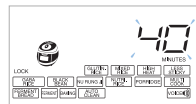

- ※ When the “Bread Baking” process is complete, Immediately remove the bread from inner pot
- ※ After the “Bread Baking” is complete, the bread is hot and you should be careful.



## HOW TO COOK USING FERMENTATION/ BREAD BAKING

▼ If there is a problem of fermentation / bread baking, check the following details

	Case	Chech point	Do the following
D O U G H	When dough is not inflated of inflated much.	<ul style="list-style-type: none"> <li>• Is capacity of the material accurate?</li> <li>• Do not have the dough is elastic with flaccid?</li> <li>• Is the surface of the dough smooth and elastic, and transparent?</li> <li>• Does fermentation time is long or short?</li> </ul>	<ul style="list-style-type: none"> <li>• Check the volume of the ingredients and knead the dough well.</li> </ul>
B A K E D  B R E A D	When bread is small and stiff.	<ul style="list-style-type: none"> <li>• Capacity of the material, the time set correctly?</li> </ul>	<ul style="list-style-type: none"> <li>• follow the correct ingredient volumes and directions for fermentation and baking time.</li> </ul>
	When bread is rough and crunch	<ul style="list-style-type: none"> <li>• Fermentation time and kneading time set correctly?</li> </ul>	
	When bread was undercooked.	<ul style="list-style-type: none"> <li>• Did you set too short fermentation time or baking time?</li> </ul>	
	When bread was overcooked.	<ul style="list-style-type: none"> <li>• Did you set too long fermentation time or baking time?</li> </ul>	
B R E A D	When the baked color of the Underside of the bread is not appered.	<ul style="list-style-type: none"> <li>• Did you put the dough in the middle of inner pot.</li> <li>• Did you set too short baking time?</li> </ul>	<ul style="list-style-type: none"> <li>• When the second fermentation is complete, the dough should be left in the middle of the inner pot. Extend the baking time.</li> </ul>
	When the bread is too sticky and wrinkled	<ul style="list-style-type: none"> <li>• Did you remove baked bread immediately?</li> </ul>	<ul style="list-style-type: none"> <li>• When the "Bread Baking" process is complete. Immediately remove the bread from inner pot</li> </ul>

# HOW TO PRESET TIMER FOR COOKING



## How to preset timer for cooking

How to preset timer for cooking

### 1 Check if the current time and the menu are correct.

- ▶ Refer to page 15 for the time setting.
- ▶ If the current time is not set correctly, the presetting time will also be incorrect.
- ▶ Make sure not to confuse AM and PM.



### 2 Turn the Lock/Unlock handle to the lock position and a lock icon will be displayed on the screen.

Then press the “Preset/AUTO CLEAN” button.

- ▶ “Menu/Selection” will blink, and “Preset/Auto Clean”, “Set”, Cancel “Pressure Cook/Turbo” buttons will turn ON.
- ▶ When Cuckoo is released to the market, Preset 1 is set at 6:30 am and Preset 2 at 7:00 pm. If you want to accept these preset times, select. Preset 1 and/or Preset 2.
- ▶ If you press the Preset/Auto Clean button while the Lock/Unlock handle is unlocked, you will not be able to set the preset time.
- ▶ If you press the Preset/Auto Cleaning button, the previous preset time will be displayed as shown in the picture and Preset 1 and Preset 2 will blink. Then you will hear a voice message: “Please set the cooking finish time with Menu/Selection button and press Pressure Cook/Turbo button or Set button.
- ▶ In GABA mode, preset on “**OH**” is possible.
- ※ If you want to preset “Timer” while keeping warm, cancel keep warm and preset the “Timer”

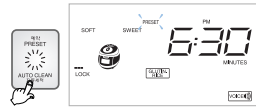

### 3 Preset the time.

- ▶ “Set” button will blink, and “Menu/Selection”, “Cancel” and “Pressure Cook/Turbo” buttons will turn ON.

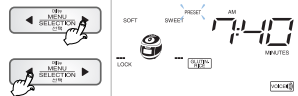

※ When preset time is set to AM07:40

### 4 Select menu with “Menu/Selection” button

- ▶ “Set button” will blink, and “Menu/Selection”, “Pressure Cook/Turbo” and “Cancel” buttons will turn ON.
- ▶ In case of setting up timer while warming 10min increase by pressing “**Q**” button
- ▶ Please set up timer after canceling warming 10min decrease when you press “**Q**” button If you keep pressing, It can be changed continuously.
- ※ Please be careful not to change from AM to PM.

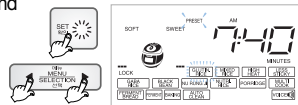

### 5 Press “Pressure Cook” button.

- ▶ “Pressure Cook/Turbo” button will blink, and “Menu/Selection” and “Cancel” buttons will be turned ON.
- ▶ It says that preset cook for glutinous is booked
- ▶ Preset cook will be completed at the timer
- ▶ Once cook is completed with preset time, Preset time is stored in the memory. Don't need to set up time again.
- ※ If a small amount of rice is cooked, rice could be finished earlier than time you set up.

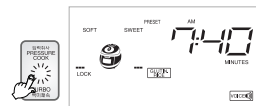



# HOW TO PRESET TIMER FOR COOKING/ HOW TO USE SIMPLE SOFT FUNCTION

## Precautions for preset cooking

- 1 In case of preset cooking
  - ▶ If the rice is not old and dry; the result may not be good.
  - ▶ If the rice is not well cooked, add more water by about half-scale.
  - ▶ If the preset time is longer, moralization could be increased.
  - ▶ Rinsed rice adds precipitated starch, Preset Cook may cause scorching.  
To reduce scorching, cook washed rice by rinsing in running water or reduce cooking amount.
- 2 The change of preset time
  - ▶ Press “Cancel” button for more than 2 seconds and restart it to change the preset time.
- 3 If the preset time is shorter than cooking time, cooking will immediately begin.
  - ▶ If set time is shorter than preset time, cooking will immediately begin.
- 4 In case the preset time is over 13 hours
  - ▶ “13Ho” will be displayed and the preset time will be changed to 13 hours automatically.
    - ex) If cooking is preset to AM07:00 of the follow day at PM5:00 of the day ,where preset time is 14 hours.  
“13Ho” will be displayed and preset time automatically to AM06:00(Preset time is 13 hours)
  - ※ If the preset time is over 13 hours, it can cause bad smell. Maximum time for Preset time is limited up to 13 hours because the rice spoils easily during the summer time.
  - ※ When you want to finish presetting P.M12:00, preset P.M 12:00.
  - ※ Use this function when you want to finish between 1 hours to 13 hours based on the preset time.
  - ※ If you press the set button to check the present time during the preset cooking function, the preset time will be displayed for 2 second.

## Possible time setting for each menu

Menu Class	Glutinous Rice	HighHeat Glutinous Rice	Mixed Rice	HighHeat Mixed Rice	Soft Glutinous Rice	GABA Rice	HighHeat GABA Rice	Nutritious Rice	Black bean	Nu rung ji	Nutritious porridge	Multi Cook	Ferment Bread	Automatic Sterilization (Steam Cleaning)
Possible time Setting	From (37minutes +My mode) to 13hours	From (42minutes +My mode) to 13hours	From (58minutes +My mode) to 13hours	From (63minutes +My mode) to 13hours	From (59minutes to 13hours	From (60minutes +My mode) to 13hours	From (64minutes +My mode) to 13hours	From 38minutes to 13hours	From (49minutes +My mode) to 13hours	From (49minutes +My mode) to 13hours	From 94minutes to 13hours	From (1minutes +My mode) to 13hours	From (1minutes +My mode) to 13hours	From 27minutes to 13hours

## Simple Soft Function

You can soak grains before stating cooking by setting a desired time with this function.

### ▶ Setting Method

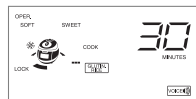
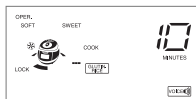

1. To activate the Simple Soft Function, “press /Auto Clan” button within 5 seconds right after CUCKOO started the menu for Glutinous Rice, Mixed Rice, Turbo Mixed Rice, Sushi Rice, Nutritious Rice, Nu Rung Ji or Black bean.
2. To change the soaking time, press “press /Auto Clan” button in simple Soft Function: the time setting can change from 10 to 30 minutes, 60 minutes, and No Soaking Time.
3. If you do not press any button for more than 5 seconds while setting the soaking time, it will be automatically set back to the current soaking time. After the soaking time is over, the cooking will start.
  - ※ Soaking time is counted by 1 minute unit.
  - ※ If you unlock the Lock/Unlock Handle during the simple Soaking Function, the cooking will be canceled.
  - ※ The longer the soaking time, the melaoizing effect.

# HOW TO USE PRESET REHEATING FUNCTION



## How to use Preset Reheating function

- ▶ Use this function when the cooked rice is not kept warm in the rice cooker but you still want to enjoy a hot meal at your convenience.
- ▶ It takes three hours before it's fully warmed up: Please use the function at least three hours before you enjoy your meal.

For example, if it is nine o'clock in the evening and you want to have warm breakfast at six thirty the next morning:

### 1 Make sure that the current time is correct

- ▶ See Page 15 for how to set the current time.
- ▶ Please make sure that the current time is correct so that the reheating process ends on time.
- ▶ Do not get confused between morning and afternoon.



### 2 Set the Lock/Unlock handle at "O" (Lock) and press Preset/Auto Clean button when the Lock icon is displayed.

- ▶ A voice will come up saying "Select menu with Preset and Selection button and press SET button."
- ▶ Menu/Selection, Keep Warm/Reheat buttons blink and after that Preset/Auto Clean, Set, Cancel and Pressure Cook/Turbo buttons light.
- ▶ Please make sure that the Lock/Unlock handle is locked properly before using the Preset function.

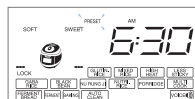

### 3 Press the Keep Warm button and Preset Reheating mode begins.

- ▶ A voice will come up saying "Please set the completion hour of reheating using Preset Reheating and Selection button and then press Keep Warm button."
- ▶ Menu/Selection button blinks and after that Keep Warm/Reheat, SET and Cancel buttons light.
- ▶ The Preset time is set to 06:30 AM when the product is delivered from the factory. If you want to preset reheating to this hour, it is not required for you to set the time.

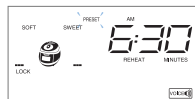

### 4 Press the Menu/Selection button to preset the completion hour of reheating.

- ▶ Keep Warm/Reheat button blinks and after that Menu/Selection, SET and Cancel buttons light.
- ▶ The completion hour is increased by 10 minutes each time you press the "D" button.
- ▶ The completion hour is decreased by 10 minutes each time you press the "Q" button. If you keep pressing the button and the time changes continuously (repetition is allowed).

※ Do not get confused between morning and afternoon.

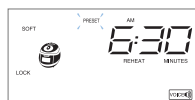
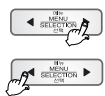

### 5 Press the SET button.

- ▶ A voice will come up saying "Press the Keep Warm button."
- ▶ Keep Warm/Reheat button blinks and after that Menu/Selection, SET and Cancel buttons light.

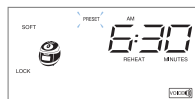

### 6 Press the Keep Warm/Reheat button.

- ▶ A voice will come up saying "Reheating will be completed today/tomorrow at 00, 00:00 AM/PM."
- ▶ Reheating is completed as scheduled.
- ▶ The cooker memorizes the hour that you have preset: You may press the Warming/Reheating button directly without having to preset the time again from the beginning.

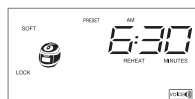



## HOW TO USE PRESET REHEATING FUNCTION

### Precautions for preset reheating

#### 1 In case of preset reheating

- ▶ When leaving cooked rice at ambient temperature for a prolonged period of time, moisture is evaporated from cooked rice. In such a case, the reheating preset may cause dehumidifying or melanosis (slightly burnt) of cooked rice.
- ▶ If there is an excessive amount of cooked rice in the pot, it may not sufficiently be reheated. It is recommended to set reheating for no more than six people(approx. half of the inner pot).
- ▶ Reheating of cold- or frozen-stored cooked rice may cause insufficient heating, dehumidifying or melanosis (slightly burnt) after completion of reheating.
- ▶ Put cold-stored cooked rice into the inner pot, beat rice with a scoop, and then reheat rice.
- ▶ Reheating of frozen-stored cooked rice shall be performed only after thawing the rice.

#### 2 Changing preset time

- ▶ Press “cancel” button for more than 2 seconds and restart it to change the preset time.

#### 3 If the preset time is beyond the available range

- ▶ If the preset time is shorter than the available range(3hours), reheating will begin immediately.

#### 4 In case the preset time is over 13 hours.

- ▶ “13H<sub>0</sub>” will be displayed and the preset time will be changed to 13 hours automatically.  
If cooking is preset to AM07:00 of the following day at PM5:00 of the day, where preset time is 14 hours, “13H<sub>0</sub>” will be displayed, and preset time automatically changes to AM06:00.  
(Maximum preset time is 13 hours)
- ※ If the preset time is over 13 hours, it can cause bad smell. The limited preset time is set up less than 13 hours because the rice spoils easily during the summer time.
- ※ When you want to finish presetting P.M 12:00, preset P.M 12:00.
- ※ Use this function when you want to finish cooking between 100 minute to 13 hours based on the preset time.
- ※ If you press the set button to check the present time during the preset cooking function, the present time will be displayed for 2 seconds.



# TO KEEP COOKED RICE WARM AND TASTY



## Precautions for preset cooking

▶ If you want to have warm rice, press the “Keep warm/ Reheat” button. “Reheat” Function will be started and you can eat fresh rice in 9 minutes.

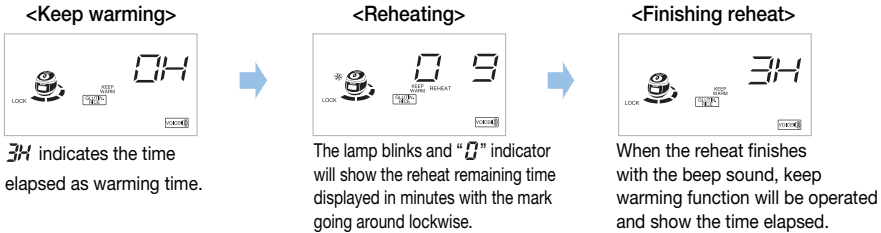

※ If you change the present time during warming, see the page 15.

- ▶ The frequent use of the “Reheat” function may cause cooked rice to be discolored or dried. Use it once or twice per day.
- ▶ If a separate heating appliance or gas burner is used to cook rice, into the cooker and press the “Keep Warm/Reheat” button to keep the rice warm. At this time, “04” is shown on the display. (Like this, transforming hot rice to a cold cooker may cause the rice to be discolored or develop an odor)
- ▶ After 24 hours of heat preservation, the lamp of heat preservation time lapse blinks, indicating that long time has passed in heat preservation condition.
- ▶ In case the lid combining hand grip is in open status during heat preservation, the cooker does not go for reheating. For reheating, lock the lid combining hand grip to (Locked) position, and then press Keep warm/reheat button.
- ▶ If the lid combining hand grip is turned to open status during reheating, function display will show “E01”. At this time, reheating will be cancelled, and heat preservation will proceed.

## Simple Soft Function

It will be hard to open the lid during warming or right after it has finished cooking, so push the pressure weight to the side and allow the steam to release.

Make sure the handle is the “Lock” position during warming or reheating.

It is recommended to evenly stir the cooked rice after cooking. The rice taste is improved (For a small quantity of rice, pile up the rice on the center area of the inner pot to keep warm)

Do not keep the scoop inside the pot while warming the rice. When using a wooden scoop it can create serious bacteria and odors.

It would be better to warm the rice for less than 12 hours because of odors and color change.

The cooked rice, which cooked by pressure cooker is more prone to changing color than the rice cooked by general cooker. During warm mode, the rice can arise and turn white and rise. In this case, mix the rice.

The mixed and brown rice cannot be in such good condition as white rice while in warm function due to their characteristics. Therefore do not keep mixed and brown rice in function for a long period of time.

Do not mix small amount rice or leftovers with the rice under keeping warm. Doing so may cause an odor. (Use a microwave oven for the cold rice)



# TO KEEP COOKED RICE WARM AND TASTY

## Controlling method of warming temperature

If the temperature in the oven is not proper, it will smell bad and the color of the rice will change so make sure to adjust the temperature.



① Press "Mode" button over 1 time during warming. It displays as picture with buzzer. At the time, 74°C mean current warming temperature.

▶ "Menu/ Selection" button will blink, and "Mode", "Set" and "Cancel" button will be turned ON.

To raise temperature



To lower temperature



※ Note: The reference temperature programmed when the product is shipped may differ from the Instruction.

②-1 Press "Menu/Selection" button to change the temperature as 74°C → 75°C → 76°C → 77°C → 78°C → 79°C → 80°C  
▶ "Set" button will blink, and "Mode", "Menu selection" and "Cancel" button will be turned ON.  
▶ To switch the functions continuously, keep pressing the button.

③ After setting temperature, press "Mode" select button. Preset temperature will be stored with buzzer sound. (If will be cancelled once press "Cancel" button or after 7 seconds without pressing any button)

②-2 Press "Menu/Selection" button to change the temperature as 74°C → 73°C → 72°C → 71°C → 70°C → 69°C  
▶ "Set" button will blink, and "Mode", "Menu selection" and "Cancel" button will be turned ON.  
▶ To switch the functions continuously, keep pressing the button.

## Change of temperature

If you want to change cooking temperature in the standby mode, "Mode Select" button over 2 seconds, and press it 2 more times, You can change cooking temperature.

## How to operate My Mode function.

Use it while opening the lid when there is too much water or rice becomes too soft.

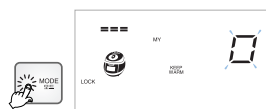

① In standby mode, push the "Mode" button 4 times. The voice says that it is programmed warming mode, control the temperature you want.

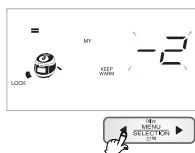
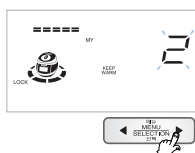

②-1 Press "Menu/Selection" button to change the Picture (up)  
▶ "Set" button will blink, and "Mode", "Menu selection" and "Cancel" button will be turned ON.  
▶ To switch the functions continuously, keep pressing the button.

③ Select the menu you want, then the press the "Mode" button and set-up time will be automatically entered with a buzzer. (If you press the "Cancel" button or do not press a button within 7 seconds, the Cancelled and returned to standby mode.)

②-2 Press "Menu/Selection" button as the picture (down)  
▶ "Set" button will blink, and "Mode", "Menu selection" and "Cancel" button will be turned ON.  
▶ To switch the functions continuously, keep pressing the button.

1. If too much water is spilled out when you open the lid : Press "Menu/Selection" button to raise the setting mode.
2. If the edge of rice is too soft : Press "Menu/Selection" button to reduce the setting mode.

# TO KEEP COOKED RICE WARM AND TASTY



## How to activate “Sleeping” mode.

- ▶ When keeping rice warm for a long time, set up the temperature low to prevent the Following quality of rice: smelly, dry, change of color: from PM 10:00- AM04:00
- ▶ How to set up



1. Hold “Mode” button for one second, then press the “mode” button 6times to set up sleeping mode.  
If sleeping mode is not shown, Keep on pressing the “mode” button until it is heard or displayed.
2. When you are in sleeping mode, it says “After selecting or canceling sleeping mode, press the set button”  
At this time, “Menu/Selection” button will blink, and the “Mode”, “Set”, and “Cancel” button will turn on.
3. Press the “Menu/Selection” button until you hear or see “Sleeping mode”, then Press “Set” button.  
You will see nothing surrounding the rice cooker on the screen.
4. In the Sleep/Warm mode, if you press “Cancel” button, the Voice message will state: “Time is over.  
The function setting has been canceled.” If no button is pressed for more than 7 seconds,  
You'll return to the Standby mode.

- ▶ How to release



1. Hold “Mode” button for one second, then press the “mode” button 6times to set up sleeping mode.  
If sleeping mode is not shown, Keep on pressing the “mode” button until it is heard or displayed.
2. When you are in sleeping mode, it says “After selecting or canceling sleeping mode, press the set button”  
At this time, “Menu/Selection” button will blink, and the “Mode”, “Set”, and “Cancel” button will turn on.
3. Press the “Menu/Selection” button until you hear or see “Sleeping mode”, then Press “Set” button.  
You will see nothing surrounding the rice cooker on the screen.
4. In the Sleep/Warm mode, if you press “Cancel” button, the Voice message will state: “Time is over.  
The function setting has been canceled.” If no button is pressed for more than 7 seconds,  
You'll return to the Standby mode.

- ▶ If you need to keep the rice warm during sleeping, do not use this function. This function makes the rice cooler than normal. In summer, the rice can be spoiled and may smell bad because of high temperature. If possible, do not use the “Custom-made warming” mode while sleeping.
- ▶ This function is set up as cancel state.

## When odors are rising during the warming mode

- ▶ Clean the lid frequently. It can cause bacteria and odors.
- ▶ Even though exterior looks clean, there might be germs and it can cause odor sure to use automatic sterilization (steam cleaning) menu for cleaning. Clean the inner pot completely after automatic cleaning function is done. (refer to 20)
- ▶ After you cook soups and steamed dishes, clean the inner pot properly to prevent rice from smelling.



# HOW TO USE POWER SAVING/ ENERGY EYE FUNCTION

## What is power saving in “Standby” mode?

- ▶ A little electricity is wasted if power cord is not plugged in. It is called manual way as standby electric power. The power saving of “Standby” mode is technology which minimizes electricity consumption

## Manual Method

### ▶ How to start power saving

Push Cancel button for 3 seconds at waiting state Saving power function is set up.



### ▶ How to end power saving

- Method 1) Push any button then it will be returned to waiting mode.  
Method 2) If lid handle is turned to open or close, power saving mod will be canceled and back to waiting state.



## Automatic Method

If the standby time is chosen as number other than “0” at the automatic power saving mode, the automatic saving power function will be operated. If you move lid handle or push any button before passing waiting time, the waiting time which is reduced will go back to the setting.

### ▶ How to set up

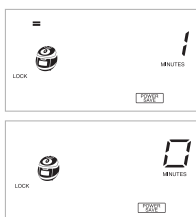

1. If you push “mode” button 8 times at the standby state, automatic power saving mode is set up.
2. When automatic power saving mod is set up, it says that this is automatic power saving mod. Press the “Set” button after selecting waiting time.
3. If you select “0” minute with “Menu/ Selection” button. Automatic saving will be canceled. After setting up waiting time you want, press the “Set” button.
4. Without pressing any button within 7 seconds or pushing “Cancel” button. Automatic power saving function will be canceled and back to waiting mode.

## Energy Eye function

The luminance sensor automatically recognizes ambient brightness during standby, cooking, warming and preset timer for minimizing power consumption of the product. If you want the power saving mode to start when it's darker than the current level(Step 2), set the mode to Step 1. If you want the mode to start when it's brighter than the current level, set the mode to Step 3. (The power saving mode of CUCKOO is set to Step 2 at the factory.)



(When selecting Energy Eye function)

(When deactivating Energy Eye function)

1. Press the Mode button 13 times in standby status and you will enter the Energy Eye mode. (Please make sure that you press the Mode button for a second or longer in the beginning.)
2. When you enter the mode, a voice comes up saying “You have entered the Energy Eye mode. Please select or deactivate the Energy Eye mode with Selection button and press SET button.” After that, Menu/Selection button blinks and Mode, SET and Cancel buttons light.
3. Each time you press the Menu/Selection button, the Energy Eye shifts from OFF to Step 1 to Step 2 to Step 3. When OFF is displayed, a voice comes up saying “Energy Eye function is deactivated.” The Set button blinks and Mode, Menu/Selection and Cancel buttons light.
4. After selecting your preferred step, please press the SET button. A voice will come up saying “Energy Eye setting has been completed” and your step will be stored.
5. This mode will be cancelled if you press the “Cancel” button or after 7 seconds without pressing any button. In this case a voice will come up saying “Time exceeded, the mode will be canceled”.

# HOW TO USE POWER SAVING/LOCK BUTTONS/ REMAINING COOKING TIME DISPLAY MODE



## Display Lighting/Power- Saving Mode

This mode adjusts the brightness of the display during cooking, warming or reservation cooking.

### ► How to set and unset the mode



1. In the Standby mode, press the Mode button 9times to activate the Display Lighting/Power- Saving mode. (Press the Mode button for more than 1 second to enter into the Display Lighting /Power-Saving mode)
2. When the Display Lighting/Power-Saving mod starts, a Voice message will state "Set or cancel the Display Lighting Function by pressing the Selection button. Then, please press the Display button "At that moment the Menu/Selection button will be switched off and Mode, Set and Cancel button will appear.
3. When you press the Menu/Selection button, a Voice message will given one of these two statements : The Display the Lighting/ Power –Saving Function is selected. Please, press the Set button. "or" The Display Lighting/ Power –Saving Function is canceled. Please press the Set button. "The Set button will then disappear and the Mode, Set and Cancel button will be turn on.
4. Press the Set Button and the Display Lighting/Power –Saving Funding will start with a Voice message stating "The Display Lighting/Power –Saving Function has been set."
5. In the Display Lighting/Power- Saving mode, press the Cancel button or do not press any button for more than 7 seconds. The setting will be canceled and you return to the Standby mode with a Voice message stating "Tim is over. The function has been canceled."

## How to Set "LOCK BUTTONS"

► Lock can be set for touch button to prevent malfunction during cleaning with touch button or by children touch.

### ► Setting Method



1. Button will be locked if "Set" button is pressed for 3 seconds or longer during cooking, presetting, warming, reheating or in standby condition.
2. When button is locked, a voice will sound saying "Button lock is selected". At this time, button lock is displayed on the screen.

### ► How to set and unset the mode



1. To cancel button lock, press "Set" button for 3 seconds or longer on locked the button.
2. "Lock" sign on the display disappears when button lock is cancelled, a voice will be saying "Button lock is cancelled".

※ Note: Any button other than Ag Set button is pressed while button lock is set, buzzer will sound.

※ Note: Desired function can be set after cancelling button lock is set, buzzer will sound.

※ Note: Button lock function is cancelled automatically when the power is off even though the button lock function is already set.

## Remaining Cooking Time Display Mode

This mode sets on or off the remaining cooking time display which appears periodically during the cooking. (The displayed remaining cooking time may vary from the actual one depending on the cooking volume and process.)

1. In the Standby mode, press the Mode button 10 times to activate the Remaining Cooking Time Display mode. (Press the Mode button for more than 1 second to enter into the Remaining Cooking Time Display mode.)
2. When the Remaining Cooking Time Display mode starts, a voice message will state "Set or cancel the Remaining Cooking Time Display Function by pressing the Selection button."
3. When you press the Menu/Selection button, a voice message will give one of these two statements: "The Remaining Cooking Time Display Function is selected. Please, press the OK button." or "The Remaining Cooking Time Display Function is canceled. Please press the OK button." The OK button will then disappear and the Mode, Menu/Selection and Cancel button will be turned on. After selecting either mode, press the OK button.
4. In the Remaining Cooking Time Display mode, press the Cancel button or do not press any button for more than 7 seconds. The setting will be canceled and you return to the Standby mode with a voice message stating "Time is over. The function has been canceled."



※ Remaining Cooking Time Display mode set off



※ Remaining Cooking Time Display mode set on

# CHECK BEFORE ASKING FOR SERVICE

▼ If there is a problem with your cooker, check the following details before requesting service to your dealer. Sometimes the cooker may not operate as desired if used incorrectly.

Case	Case	Do the following
<b>When the rice is not cooked.</b>	<ul style="list-style-type: none"> <li>•Pressure Cook/Turbo “button is pressed?</li> <li>•Is there power cut while in cooking?</li> </ul>	<ul style="list-style-type: none"> <li>•Press the “Pressure Cook button once. And check “ [ ] ” sign on the display.</li> <li>•Re-press the “Pressure Cook/Turbo” button.</li> </ul>
<b>When the rice is not well cooked.</b>	<ul style="list-style-type: none"> <li>•Did you use the measuring cup for the rice?</li> <li>•Did you put proper amount of water?</li> <li>•Did you rinse the rice before cooking?</li> <li>•Did you put rice in water for a long time?</li> <li>•Is the rice old or dry?</li> </ul>	<ul style="list-style-type: none"> <li>•Refer to page 17-18</li> <li>•Add water about half the notch and then cook.</li> </ul>
<b>Bean (other grains)is half cooked.</b>	<ul style="list-style-type: none"> <li>•Is been (other grains) too dry?</li> </ul>	<ul style="list-style-type: none"> <li>•Soak or steam beans and other grains before cooking in the pressure cooker in order to avoid partially cooked beans or grains. Beans should be soaked for -2-minutes or steamed for-2- minutes prior to cooking, depending on your taste.</li> </ul>
<b>Rice is too watery or stiff.</b>	<ul style="list-style-type: none"> <li>•Is the menu selected correctly?</li> <li>•Did you properly measure water?</li> <li>•Did you open the top cover before cooking was finished?</li> </ul>	<ul style="list-style-type: none"> <li>•Select the correct menu.</li> <li>•Properly measure water.</li> <li>•Open the top cover after cooking finished</li> </ul>
<b>When the water overflows.</b>	<ul style="list-style-type: none"> <li>•Did you use the measuring cup?</li> <li>•Did you use proper amount of water?</li> <li>•Is the menu selected correctly?</li> </ul>	<ul style="list-style-type: none"> <li>•Refer to page 17-18</li> </ul>
<b>When you smell odors while warming.</b>	<ul style="list-style-type: none"> <li>•Did you close the top cover?</li> <li>•Please check it the power cord is plugged.</li> <li>•Did it warm over 12 hours?</li> <li>•Is there any other substance such as rice scoop or cold rice?</li> <li>•Is been (other grains) too dry?</li> </ul>	<ul style="list-style-type: none"> <li>•Select the correct menu.</li> <li>•Properly measure water.</li> <li>•Open the top cover after cooking finished</li> </ul>
<b>“E_ _ , E_P, E_ t ” Signs show up.</b> <b>“” Signs show up.</b>	<ul style="list-style-type: none"> <li>•Temperature sensor or fan motor does not work properly.</li> </ul>	<ul style="list-style-type: none"> <li>•Unplug the power cord and call the Service center.</li> </ul>
<b>Warming passed time mark blinks during keeping warm.</b>	<ul style="list-style-type: none"> <li>•24 hours has not passed yet after Keeping warm</li> </ul>	<ul style="list-style-type: none"> <li>•This function alarms if the rice remained warm for more than 24 hours.</li> </ul>
<b>Rice has gotten cold or a lot of water flow during Keeping warm</b>	<ul style="list-style-type: none"> <li>•Keeping warm was set in “Sleeping” mode</li> </ul>	<ul style="list-style-type: none"> <li>•Keep warm after cancelling or setting “Sleep Keeping Warm” mode depending on the necessity.</li> </ul>
<b>If “ E do ” sign is appeared.</b>	<ul style="list-style-type: none"> <li>•It shows on the display when pressing “Start” button again, or when the cooking has finished and you’ve never ever open turned the handle to “Unlock”</li> </ul>	<ul style="list-style-type: none"> <li>•It can be solved by turning handle to “Unlock” and then turn to “Lock”</li> </ul>
<b>“ E co ” sign shows up</b>	<ul style="list-style-type: none"> <li>•Detachable cover is not mounted</li> </ul>	<ul style="list-style-type: none"> <li>•Mount detachable cover(Refer to page 12)</li> <li>•If “ E co ” sign is displayed continuously even though you already installed detachable cover, please contact customer service.</li> </ul>
<b>Alarm sounds or reheating does not work while keeping warm</b>	<ul style="list-style-type: none"> <li>•Is detachable cover mounted?</li> </ul>	<ul style="list-style-type: none"> <li>•Mount detachable cover(Refer to page 12)</li> </ul>

# CHECK BEFORE ASKING FOR SERVICE

▼ If there is a problem with your cooker, check the following details before requesting service to your dealer. Sometimes the cooker may not operate as desired if used incorrectly.

Case	Case	Do the following
When the button cannot operate with “ <b>L</b> ”	<ul style="list-style-type: none"> <li>• Is the inner pot inserted?</li> <li>• Check the rated voltage?</li> </ul>	<ul style="list-style-type: none"> <li>• Please insert inner pot.</li> <li>• This product is 120V only</li> </ul>
When the pressure “Cook/Turbo” Timer button does not operate with “ <b>E01</b> ”	<ul style="list-style-type: none"> <li>• Did you turn the Lock/Unlock Handle to “Lock”</li> <li>• Is “pressure” lamp on?</li> </ul>	<ul style="list-style-type: none"> <li>• Please turn the “Lock/Unlock” handle to “Lock”</li> </ul>
When the rice is badly sticky.	<ul style="list-style-type: none"> <li>• Is there any rice or any other alien substance on the temperature sensor or the bottom surface of the inner pot?</li> </ul>	<ul style="list-style-type: none"> <li>• Clean all the alien substances on the temperature sensor or the bottom surface of the inner pot.</li> </ul>
When “ <b>E03</b> ” is showed on the LCD	<ul style="list-style-type: none"> <li>• Check the rated Voltage?</li> </ul>	<ul style="list-style-type: none"> <li>• Cut the power and contact customer service.</li> <li>• It is normal to get “<b>E03</b>” when putting only water.</li> <li>• This is only for 120V</li> </ul>
When the time cannot be preset.	<ul style="list-style-type: none"> <li>• Is the current time correct?</li> <li>• Is AM or PM set properly?</li> <li>• Did you set the reservation time over 13 hours?</li> </ul>	<ul style="list-style-type: none"> <li>• Set the current time(Refer to page 15)</li> <li>• Check the AM and PM</li> <li>• Maximum reservation time is 13 hours. (Refer to page 29~30)</li> </ul>
When you smell after and before cooking?	<ul style="list-style-type: none"> <li>• Is the inner pot correctly inserted in the main body?</li> <li>• Is the Lock/Unlock handle on the top cover set to “Lock”?</li> <li>• Is there hot food in the inner pot?</li> </ul>	<ul style="list-style-type: none"> <li>• Please put in the inner pot perfectly</li> <li>• Please turn the “Lock/Unlock” handle to “Lock”</li> <li>• Pull the pressure handle to aside once.</li> </ul>
When “ <b>E_U</b> ”, “ <b>00</b> ” are shown on the LCD by turns	<ul style="list-style-type: none"> <li>• Micom power is out</li> </ul>	<ul style="list-style-type: none"> <li>• Please cut the power and contact customer service</li> </ul>
When “ <b>E_P</b> ”, “ <b>00</b> ” are shown on the LCD by turns	<ul style="list-style-type: none"> <li>• The sensor is broken</li> </ul>	<ul style="list-style-type: none"> <li>• Please cut the power and contact customer service</li> </ul>
“ <b>E_UF</b> ” mark shows up during the product operation	<ul style="list-style-type: none"> <li>• Micom memory is out.</li> </ul>	<ul style="list-style-type: none"> <li>• Please cut the power and contact customer service</li> </ul>
“ <b>H_H</b> ” or “ <b>H_H</b> ” mark shows up during the product operation		<ul style="list-style-type: none"> <li>• It might be power problem or time for maintenance. Please contact customer service if problem continues.</li> </ul>

# CHECK BEFORE ASKING FOR SERVICE

▼ If there is a problem with your cooker, check the following details before requesting service to your dealer. Sometimes the cooker may not operate as desired if used incorrectly.

Case	Case	Do the following
<b>When cannot turn to "Unlock"</b>	<ul style="list-style-type: none"> <li>• Did you turn the "Lock/Unlock" handle while cooking?</li> <li>• Did you turn the "Lock/ Unlock" handle Before exhausting steam completely?</li> </ul>	<ul style="list-style-type: none"> <li>• Don't open the top cover while Cooking.If you want to open top cover while cooking, Press the "Cancel" button more than 2 seconds and release the steam.</li> <li>• Pull the pressure handle to the Side once and allow the steam to release.</li> </ul>
<b>When the top cover cannot open although the Lock/Unlock handle is turned to "Unlock"</b>		<ul style="list-style-type: none"> <li>• Because of the pressure.</li> <li>• Pull the pressure knob to aside once and exhaust the steam completely.</li> </ul>
<b>When the steam exhausted Between the top cover.</b>	<ul style="list-style-type: none"> <li>• Is there an External substance on the Packing?</li> <li>• Is packing too old?</li> </ul>	<ul style="list-style-type: none"> <li>• Clean the packing with duster.</li> <li>• Keep the packing clean.</li> <li>• If the steam is exhausted through the top cover, please power off the contact the service center and Dealer.</li> <li>• Packing life cycle is 12 month, please replace the packing per 1year</li> </ul>
<b>When the "Cancel" button Does not operate while cooking.</b>	<ul style="list-style-type: none"> <li>• Is the inner pot hot?</li> <li>• Is currently the setting to lock mode?</li> </ul>	<ul style="list-style-type: none"> <li>• Keep pressing the "Cancel" button for 2 seconds for safety reason if you want to cancel while cooking.</li> <li>• Be careful of hot steam emission or hot contents spattered from the automatic steam outlet during cancellation.</li> <li>• Please press "Set" button for over 3 seconds to release.</li> </ul>
<b>When you hear weird noises during cooking and warming</b>	<ul style="list-style-type: none"> <li>• Is there a wind blowing sound when cooking the rice?</li> <li>• Is there a "chi" sound when warming the rice?</li> </ul>	<ul style="list-style-type: none"> <li>• Is the inner pot inserted?</li> <li>• Check the rated voltage?</li> </ul>
<b>Brown rice is not germinated properly</b>	<ul style="list-style-type: none"> <li>• Does the amount of rice exceed the specified maximum capacity?</li> <li>• Is the brown rice too old?</li> </ul>	<ul style="list-style-type: none"> <li>• Put the specified maximum capacity of brown rice.</li> <li>• Old rice or contaminated rice may not be germinated properly. (Refer to page 24)</li> </ul>



MEMO



## CUCKOO ELECTRIC RICE COOKER/WARMER LIMITED WARRANTY

KEY Company, P&K USA TRADING CORP and Cuckoo Trading Canada. will repair at its option replace, without charge, your product which proves to be defective in material or workmanship under normal use, during the warranty period listed below from the date of original purchase. This warranty is good only to the original purchaser of the product during the warranty period. P&K USA TRADING CORP covers the east and the central districts, KEY Company covers the west and the central districts, Cuckoo Trading Canada covers the whole Canada.

<b>MODEL#</b>	<b>#LABOR</b>	<b>PARTS</b>	<b>WARRANTY PERIOD</b>	<b>HOW SERVICE IS HANDLED</b>
CRP-BH06	1YEAR	1YEAR		The East and the Central Districts Call : 718 888 9144 Address : 5-48 46th Road Long Island City, NY 11101, USA
				The West and the Central Districts. Call : 323 780 8808 Toll Free : 877 481 9828 Address : 1137 E. 1st Street. L.A, CA 90033, USA
				Canada (TORONTO) Call : 416 878 4561 / 905 707 8224 Address : #D8-7398 Yonge Street Thornhill Ontario Canada L4J 8J2
				Canada (VANCOUVER) Call : 604 540 1004 / 604 523 1004 Address : 945 Lougheed Hwy Coquitlam BC Canada V3K 3T4

No other express warranty is applicable to this product. **THE DURATION OF ANY IMPLIED WARRANTIES, INCLUDING THE IMPLIED WARRANTY OF MERCHANTABILITY, IS LIMITED TO THE DURATION OF THE EXPRESS WARRANTY HEREIN. CUCKOO ELECTRONICS CO.,LTD, SHALL NOT BE LIABLE FOR THE LOSS, THE USE OF THE PRODUCT, INCONVENIENCE, LOSS OR ANY OTHER DAMAGES, DIRECT OR CONSEQUENTIAL, ARISING OUT OF THE USE OF, OR INABILITY TO USE, THIS PRODUCT OR FOR ANY BREACH OF ANY EXPRESS OR IMPLIED WARRANTY, INCLUDING THE IMPLIED WARRANTY OF MERCHANTABILITY APPLICABLE TO THIS PRODUCT.**

Some states do not allow the exclusion or limitation of incidental or consequential damages or limitations on how long an implied warranty lasts : so these limitations or exclusions may apply to you. This warranty gives you specific legal rights and you may also have other rights which vary from state to state.

**THE ABOVE WARRANTY DOES NOT APPLY IN THESE CASES:**

- \* To damages problems which result from delivery or improper installation.
- \* To damages problems which result from misuse, abuse, accident, alteration, or incorrect electrical current or voltage.
- \* To serve call which do not involve defective workmanship or material and explaining the operation of the unit.

**Therefore, these costs are paid by the consumer. Customer assistance numbers :**

**To Prove warranty Coverage :** ► **Retain your Sales Receipt to prove date of purchase**  
 ► **Copy of your Sales Receipt must submitted at the time warranty service is provided.**

**To Obtain Product, Customer, or Service Assistance and Nearest Authorized service center, Parts Distributor or Sales Dealer:**

The East and the Central Districts  
Call : 718 888 9144  
Address : 5-48 46th Rd.  
Long is land City, NY 11101

The West and the Central Districts.  
Call : 213 687 9828  
Toll Free : 877 481 9828  
Address : 700 Jackson Street, L.A,  
CA 90012, USA

Canada (Toronto)  
Call : 416 878 4561 / 905 707 8224  
Address : #D8-7398 Yonge Street  
Thornhill Ontario Canada  
L4J 8J2

Canada (Vancouver)  
Call : 604 415 9658/604 524 8282  
Address : 103-4501 North Road  
Burnaby BC Canada  
V3R 4R7