

사용설명서 Operating Instructions

## CRP-AH10 Fuzzy Series

1.8L(2~10Persons) / 1.8L(2~10인분)

**CUCKOO**  
always new

happiness

## NO.1 CUCKOO

CUCKOO IH PRESSURE JAR COOKER

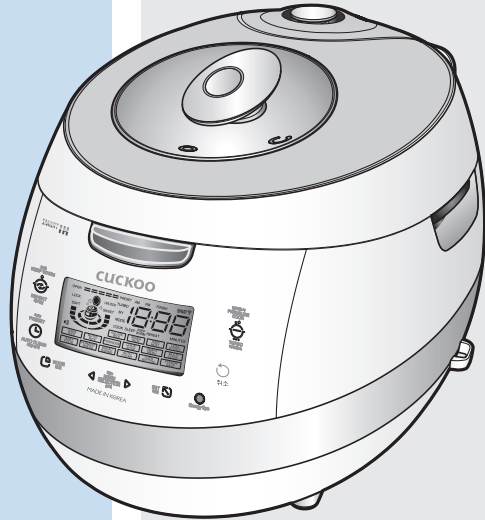

love

design

emotion

CUCKOO ELECTRONICS CO., LTD.

# CONTENTS

Thank you very much for purchasing “CUCKOO”  
Electric Rice cooker/warmer

Read the following instruction manual before use. Save this instruction manual for future reference. This manual will be useful if you have any questions or have problems operating the rice cooker.

저희 쿠쿠 인력보온밥솥을 이용해 주셔서 대단히 감사 드립니다.

이 사용설명서는 잘 보관하여 주십시오.  
사용 중에 모르는 사항이 있을 때나 기능이 제대로 발휘되지 않을 때 많은 도움이 될 것입니다.

## CONTENTS

### BEFORE USING

Important safeguards	3
Specifications	4
Safety precautions	5-8
Name of each part	9
How to clean	10-11
Function operating part	12
Error code and possible cause	12

### WHEN USING

How to set current time	13
How to set or cancel voice guide function	13
Night voice volume reduction / voice setting function	14
Before cooking rice	15
For the best taste of rice	16
How to cook	17-18
MY MODE (Cuckoo Customized Taste Function)	19-20
How to use “GABA Rice (Brown rice)”	21-22
How to cook the MULTI-COOK	23
How to cook using fermentation bread baking	24-25
How to preset timer for cooking	26-27
How to use Preset Reheating Function	28-29
To keep cooked rice warm and tasty	30-32
How to use power saving/energy eye function	33
Display Lighting power saving mode	34
How to lock buttons	34
How to use Remaining Cooking Time Display Mode	34
How to use the NFC Function	35-40

### BEFORE ASKING FOR SERVICE

Check before asking for service	41-43
---------------------------------	-------

## 목 차

### 사용하기전에

Important safeguards	3
제품규격	4
안전상의 경고	44-47
각 부분의 이름	48
제품 손질 방법	49-50
기능 조작부의 이름과 역할	51
기능 표시부의 이상점검 기능	51

### 사용할 때

현재시각의 설정	52
음성안내 기능의 설정과 해제	52
야간 음성볼륨 줄임 기능 / 음성 설정 기능	53
취사전 준비사항	54
맛있는 밥을 드시려면	55
취사는 이렇게 하십시오	56-57
쿠쿠 맞춤밥맛 기능은 이렇게 하십시오	58-59
현미/발아는 이렇게 하십시오	60-61
멀티쿡은 이렇게 하십시오	62
발효빵은 이렇게 하십시오	63-64
예약 취사는 이렇게 하십시오	65-66
예약 재가열은 이렇게 하십시오	67-68
밥을 맛있게 보온하려면	69-71
절전기능/에너지 아이 기능은 이렇게 하십시오	72
화면조정 절전기능은 이렇게 하십시오	73
버튼잠금 기능은 이렇게 하십시오	73
취사잔여 시간 표시기능은 이렇게 하십시오	73
NFC 사용방법	74-79

### 고장 신고 전에

고장신고 전에 확인 하십시오	80-82
-----------------	-------

## IMPORTANT SAFEGUARDS

1. Read all instructions before using this appliance.
2. Do not touch hot surfaces. Use handles or knobs.
3. To protect against fire, electric shock and / or injury to persons do not immerse cord, plugs, or Pressure
4. Close supervision is necessary when this appliance is used by or near children.  
This appliance is not intended for use by young children without supervision.
5. Unplug from outlet when not in use and before cleaning.  
Allow appliance to cool before putting on or taking off parts, and before cleaning the appliance.
6. Do not operate any appliance with a damaged cord or plug, after the appliance malfunctions, or has been damaged in any manner. Return the Appliance to the nearest authorized service facility for examination, repair or adjustment.
7. The use of accessory attachments not recommended by the appliance manufacturer may result in fire, electric shock, and / or injury to persons.
8. If the supply cord is damaged, it must be replaced by a special cord or assembly available from the manufacturer or your service agent.
9. Do not use outdoors.
10. Do not let the cord hang over the edge of a table or counter, or touch hot surfaces.
11. Do not place on or near a hot gas, electric burner, or in a heated oven.
12. Always attach the plug to the appliance first, then plug the cord into the wall outlet. To disconnect, or set all control to "off", then remove the plug from the wall outlet.
13. Do not use this appliance for other than its intended use.
14. Extreme caution must be used when moving an appliance containing hot oil or any hot liquids.
15. Oversized foods, metal foil packages, or utensils must not be inserted into the appliance as they are a risk of fire or electric shock.
16. A fire may occur if the appliance is covered or touching flammable material, including curtains, draperies, walls, etc while in operation.
17. To reduce the risk of electric shock, cook only in the provided removable container.
18. This appliance cooks under pressure. Improper use may result in scalding injury.  
Before operating the unit, properly secure and close the unit. See "Operating Instructions."
19. Do not cook foods such as applesauce, cranberries, cereals, macaroni, spaghetti, or other foods.  
These foods tend to foam, froth, and sputter, and may block the pressure releasing device.
20. Before use always check the pressure releasing device for clogging.
21. Do not open the pressure cooker until the unit has cooled and internal pressure has been reduced.  
See "Operating Instructions."
22. Do not use this pressure cooker to fry in oil.
23. Be sure that handles are assembled and fastened properly before each use.  
Cracked, broken or charred handles should be replaced.

## SAVE THESE INSTRUCTIONS THIS APPLIANCE IS FOR HOUSEHOLD USE ONLY

## ADDITIONAL IMPORTANT SAFEGUARDS

**WARNING :** This appliance generates heat and releases steam during use. Use proper precaution to prevent risk of burns, fires, other injuries, or damage to property.

1. Keep hands and face away from the Pressure Release Valve when releasing pressure.
2. Take extreme caution when opening the Lid after cooking. Severe burns can result from steam inside.
3. Never open the Lid while the unit is in operation.
4. Do not use without the inner Pot in place.
5. Do not cover the Pressure Valve with anything as an explosion may occur.
6. Do not touch the inner pot nor any heating parts, immediately after use.  
Allow the unit to cool down completely first.

# HOW TO USE EXTENSION CORD

## Note:

- A. A short power-supply cord (or cord set) is provided to reduce the hazards from entanglement by a longer cord.
- B. Extension cord should be used properly.
- C. Extension cord usage for the rice cooker:
  - (1) The correct rated voltage should be used for the rice cooker.
  - (2) If the appliance is set on the ground, the extension cord should also be set on the ground.
  - (3) The cord wires and extension cord should always be arranged to prevent hazards to children.

This appliance has a polarized plug : (one blade is wider than the other).

As a safety feature, this plug will fit in a polarized outlet only one way.

If the plug does not properly fit in the outlet, turn the plug over.

If it still does not fit, contact a qualified electrician.

Please, keep this safety feature.

# SPECIFICATIONS / 제품규격

Model Name(모델명)		CRP-AH10 Fuzzy Series	
Power Supply(전원)		AC120V, 60Hz	
Power Consumption(소비전력)		1305W	
Cooking Capacity (취사용량)	Glutinous Rice(백미)	0.36~1.8L (2~10cups)	
	Mega Heat Glutinous Rice(고화력백미)		
	Mixed Rice(잡곡)		
	Mega Heat Mixed Rice(고화력잡곡)	0.36~1.44L (2~8cups)	
	Soft Glutinous(soft백미)		
	Turbo Glutinous Rice(백미패속)	0.36~1.08L (2~6cups)	
	Turbo Mixed Rice(잡곡패속)		
	GABA(현미/발아)		
	Mega Heat GABA Rice(고화력현미/발아)		
	Black Bean(검은콩)		
	Nutritious Rice(영양밥)		
Nu Rung Ji(누룽지)			
Porridge(죽)			
Power Cord Length(전원코드 길이)			1.0m
Pressure(사용압력)			88.2KPa(0.9kgf/cm <sup>2</sup> )
Weight(중량)		7.9kg	
Dimension(치수)	Width(폭)	30.1cm	
	Length(길이)	41.2cm	
	Height(높이)	29cm	

# HOW SERVICE IS HANDLED



**USA** The East and the Central Districts  
Tel. No. 718 888 9144  
The West and the Central Districts  
Tel. No. 323 780 8808

**Canada** TORONTO  
Tel. No. 905 707 8224 / 416 878 4561  
VANCOUVER  
Tel. No. 604 540 1004 / 604 523 1004

# SAFETY PRECAUTIONS



- Read the following product safety guide carefully to prevent any accidents and/or serious danger.
- 'Warning' and 'Caution' are different as follows.

<p><b>Warning</b></p> <p>This means that the action it describes may result in death or severe injury.</p>	<p> This sign is intended to remind and alert that something may cause problems under the certain situation.</p>
<p><b>Caution</b></p> <p>This means that the action it describes may result in injury or property damage.</p>	<p> Indicates a prohibition</p> <p> Indicates an instruction</p>

## Warning Do not

**Do not cover the automatic steam outlet or pressure weight with your hand or face.**

- It can cause burns.
- Especially be careful to keep it out of children's reach.



**Please pay careful attention against water and chemicals.**

- It can cause an electric shock or fire.



**Do not use the cooker near hot things such as stove, gas stove or direct ray of light.**

- It can cause an electric shock, fire, deformation, malfunction or discoloration.
- Please check the power cord and plug frequently.



**Use a single socket with the rated current above 15A.**

- Using several lines in one socket can cause overheating or fire. Please check the power cord and plug frequently
- Use an extension cord with the rated current above 15A.



**Do not alter, reassemble, disassemble or repair.**

- It can cause fire, electric shock or injury.
- For repair, contact dealer or the service center.



**Do not use damaged power cord, plug or loose socket.**

- Please check the power cord frequently for damage.
- Serious damage can cause electric shock or fire.
- If the plug is damaged, contact the dealer or a service center.

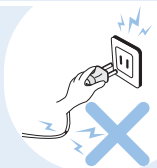

**Do not let the cooker contact any water by sprinkling water on the cooker.**

- It can cause an electric shock or fire.
- If it contacts water, please separate power cord and contact dealer and service center.



# SAFETY PRECAUTIONS

## Warning

## Do not

**Do not cover the automatic steam outlet or pressure weight with a duster, a towel, or apron, etc.**

- It can cause deformation or a breakdown.
- It can cause an explosion by pressure.

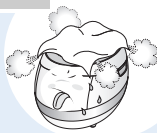

**Don't spray or put any insecticide and chemicals.**

- It can cause an electric shock or fire.
- If cockroaches or any insects get inside the cooker, please call a dealer or a service center.



**Do not use pots that are not designed for the cooker.  
Do not use abnormal pot and do not use without inner pot.**

- It can cause an electric shock or fire.



**Do not put any needle, cleaning pin etc in the ventilator or any gap of the cooker.**

- Do not insert cleaning pins to other parts except to the valve hole of the pressure weight.
- It can cause an electric shock or fire.

**Do not use it without the inner pot**

- It can cause electric shock or malfunction.
- Do not pour rice or water without the inner pot.
- If rice or water gets in then do not turn the product over or shake it please contact to dealer or service center.

**Do not open the top cover during heating and cooking.**

- It can cause burns.
- If you need to open the lid while cooking, keep pressing the cancel button for 2 seconds and confirm internal steam is released, completely turning the pressure weight over.

**Do not turn the Lock/Unlock Handle to "Unlock" during cooking**

- The hot steam or any hot content within the cooker can cause burns.
- After you finish the cooking do not try to open the cooker by force until the steam is completely exhausted.

**Do not place heavy things on the power cord.**

- It can cause an electric shock or fire.

**Remove external substances on plug with a clean cloth.**

- It can cause fire.  
Please check the power cord and plug frequently.

**Do not cover the automatic steam outlet**

- It can cause an electric shock or short circuit resulting in fire. Please check the power cord and plug frequently.



**Do not insert metal objects such as pins and wires or any other external substances in the automatic steam exhaust outlet or any other slot.**

- It can cause an electric shock or fire.
- Especially be careful to keep it out of reach of children.



**Be careful that both the plug and power cord are not to be bit by animals, or pierced by sharp metal materials.**

- Damages by impact can cause an electric shock or fire. Please check the power cord and plug frequently.



**Keep the cooker out of children's reach.**

- It can cause burns, electric shock or injury.

# SAFETY PRECAUTIONS



## Warning

## Remember

**Do not use on a rice chest or a shelf.**

- Do not place the power cord between furniture. It can cause an electric shock resulting in fire. Please check the power cord and plug frequently.
- When using on furniture be cautious of steam release As it can cause damage, fire and and/or electric shock.

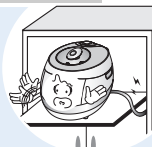

**Clean any dust or external substances off the temperature sensor and inner pot.**

- It can cause a system malfunction or fire. it out of children's reach.



**If you use cardiac pacemakers or electrical medical supporting equipment, consult a doctor before using this unit.**

- When this unit is working, it can influence any electrical medical equipment.



**Do not plug or pull the power cord with wet hands.**

- It can cause an electric shock.

## Caution

## Do not

**Please contact dealer or service center if a strange smell or smoke has occurred.**

- It can cause an electric shock.

**Do not use over the maximum capacity.**

- It can cause overflow or breakdown.
- Do not cook over capacity stated for cooking of chicken soup and congee.

**Do not touch the metallic surface of the inner pot and pressure weight after cooking or warming.**

- It can cause burns.
- Remaining hot steam can cause burns when you tilt the pressure weight during and after the cooking.

**Don't use the cooker near a magnetic field.**

- It can cause burns or breakdown.



**Please pull out the plug when not in use.**

- It can cause electric shocks or fire.
- Use AC 120V only.

**Use product on a flat surface. Do not use on a cushion. Please avoid using it on an unstable location prone to falling down.**

- It can cause malfunction or a fire. Please check.
- the power cord and plug frequently.



**Please use the cooker for original purposes.**

- It can cause the malfunction or smell.

**Don't use for various purposes for inner pot.**

- It can cause deformation of the inner pot.
- It can cause to spill the inner coating.

**Do not drop the cooker or impact.**

- It can cause malfunction.



## SAFETY PRECAUTIONS

### Warning

#### Do not place on rough top or tilted top.

- It can cause burns or breakdowns.
- Be careful to install the power cord to pass without disruption.



### Do not

#### When the exterior of inner pot is diamond shield plated.

- Use dry kitchen cleaner or sponge to clean the inner pot since rough scrub or metallic ones might cause scratch on the exterior of the plating.
- The friction of the inner pot with sink or other appliances can cause its plating's coming off. (No problem to use it)

#### Do not hold the cooker by the inner pot handle.

- It can cause problems and danger. There are portable handles on the bottom right and left side of the cooker. Hold the handles with both hands and move it carefully.

#### Please call customer service if the inner pot coating peels off.



- Oven coating may wear away after long use.
- When cleaning the inner pot, do not use tough scrubber, metallic scrubber, brush, abrasive metallic etc.

#### After you finish cooking, do not try to open the cooker by force until the steam is completely exhausted.



- The hot steam or any hot content within the cooker can cause burns.
- Cautiously open the top cover after cooking is done to avoid dangerous steam and burns.

### Caution

#### Be cautious when steam is being released

- It can cause burns.
- Especially be careful to keep it out of children's reach.

#### When you pull out the power plug, don't pull the power cord. Please, safely pull out the power plug.

- If you inflict impact on power cord, it can cause an electric shock or fire.



### Remember

#### If power fails during rice cooking, automatic steam release may work, leading to dispersion of contents.

- Cook rice with specified amounts of rice and water.
- In particular, water more than specified amount may cause overflowing of contents.
- Cook rice while soft steam cap is mounted.

#### Do not keep easily spoiled food warm in the product such as red bean rice, mixed food, croquette or gratin. (Except white rice)

#### Wipe off any excessive water on the cooker after cooking.

- It can cause odor and discoloration.
- Wipe off water that is left behind from dew.



#### Please clean the body and other parts after cooking.



- After cooking chicken soup or, multi cook dishes, etc., the smell may be absorbed.
- Clean the oven packing, top heater plate and inner pot every time you cook any of those.
- Use dry kitchen cleaner or sponge to clean the inner pot, since rough scrub or metallic ones are abrasive to the coating. (Refer to page 10~11)
- Depending on the using methods or user's circumstances inner pot coating might rise. Please call the customer service for those cases.

#### Even if power plug is unplugged, turn lid combining hand grip always to (Lock) location.



- In case My Cauldron is hot or hot cooked rice is left after cooking is completed, close lid and turn lid combining hand grip to  (Lock) direction even after unplugging power plug. Otherwise product deformation or damage may occur by internal pressure.
- Be sure to turn lid combining hand grip to  (Lock) direction during cooking and heat preservation before use.

#### Maintain more than 30cm of distance from the product while using.

- A magnetic field can be released from electronic goods.



# NAME OF EACH PART



## Name of each part

### Soft Steam Cap

### Pressure Weight

Always keep it horizontal. It stabilizes steam inside of the oven. Pressure weight is twisted, it release steam.

### Automatic Steam Exhaust Outlet (Solenoid valve)

When finished cooking or during warming, steam is automatically released.

### Lock/Unlock Handle (Set the handle to lock when cooking or warming the rice)

The handle has to turn to 'Lock' for operation.

### Lid Clamp

Turn handle to 'Unlock', and then press Clamp knob to open.

### Control Panel

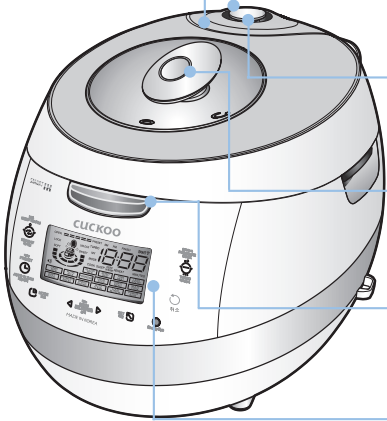

## Accessories



Manual & Cooking Guide



Rice Scoop



Rice Measuring Cup



Steam Plate

## Name of each part

### Pressure Packing

### Lid Assy

### DET. cover

### Control Plate Packing

### Control Plate Packing Cover

### Pressure Control Plate

### Holder Guide

### Handle

### DET. cover Holder

### Drain Dish

Empty the water out of a dew dish after cooking or keep warming, Leaving the water in the dew dish results in bad smell.



### Pot Handle

Place the inner pot into the body property.

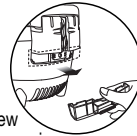

### Rice Scoop holder

### Power Plug

### Power Cord

### Temperature Sensor

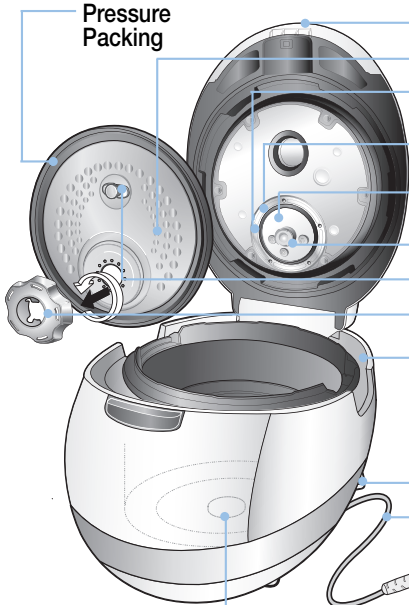

Cleaning Pin (Attached on the bottom of the unit)



# HOW TO CLEAN

- To prevent foul odor clean the lid assy after the rice cooker has cooled and the rice cooker is unplugged.
- Body and cover should be cleaned with a dry dish towel. Do not use betel while using rice cooker, starch can remain. No effect on health.
- Do not put materials like screws into holes of detachable cover. Check the back cover and front cover.

## Detachable cover & Pressure packing

### After cleaning detachable cover, put it back on the lid

Unless detachable cover is mounted, preset cooking cannot be done. (Alarm may sound while keeping warm.)

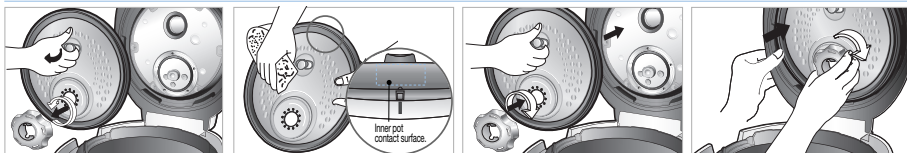

- ① Turn the holder counter clock wise, and the cover will be easily separated from the cooker and can be washed.
- ② Wash the cover with cooking purposed neutral detergent and sponge frequently, and wipe off moisture with handkerchief.
- ③ Please keep clean the edge of rubber packing, then the rice cooker last's longer.
- ④ When mounting the cover, grab separate cover handle, attach it to hole, and after adjusting holder on top of packing stop tab, fix it by turning it clockwise.
- ⑤ It is easier to attach the cover holder when the power part of the detachable cover is pressed.

Please fix a rubber packing into the cover plate completely after washing or replacing the rubber packing.



- ① To separate the rubber packing, please pull it out from the cover plate as shown in the picture.
- ② To put back the rubber packing, please fit it to each of 6 projections and holes as shown in the picture.
- ③ After fitting 6 projections to the holes, please press the rubber packing around the corner completely as shown in the picture.
- ④ Please check that the rubber packing fits into the cover plate completely. If not, steam may be released from the crack between the packing and the plate.



Make sure to clean the clean steam vent after/before use. Do not try to pull out the clean steam vent and safety packing, clean it with care. Make sure the clean steam vent and safety packing are installed completely after/before use. If the steam vent is detached, or not attached completely, please contact customer service.

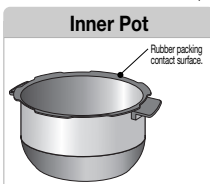

Wipe the water on the outside and bottom of the Inner Pot. A rough sponge, a brush or an abrasive can cause scratches on the coating. Use a dishwashing liquid and a soft cloth or a sponge.

※ Keeping the contact area of the Inner Pot with the pressure packing always clean, increases the product's durability.



Wipe the main unit with a wet cloth that has been extracted out of all water

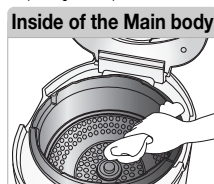

Make sure to clean the steam control vent before and after use.

## Detachable cover & Pressure packing

1. Handle must be turned to "Lock" during Cooking.  
When the lamp is turned on it means that it is ready to cook.
  2. After cooking, turn the handle from "Lock" to "Unlock" turn the handle to open. If there is unreleased steam in the Inner pot it might be hard to turn the handle. In this case twist the pressure weight and let the excess steam out. Do not open by force.
  3. Handle must be turned to "Unlock" when opening and closing.
- If the lamp does not turn on, it would not operate the "Cook" and "Preset" buttons. Make sure the handle is located in "Lock".

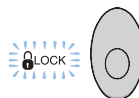



## How to clean the pressure weight nozzle.

### If the valve of the pressure part is clogged, puncture it with the cleaning pin

- The valve hole of the pressure weight allows steam to release. Check regularly to ensure that it not blocked. If the valve hole of the pressure weight is blocked, the hot steam and hot content within the cooker can cause serious injury.
- ※ Do not use the cleaning pin for any other use except to clean the valve hole of the pressure weight.

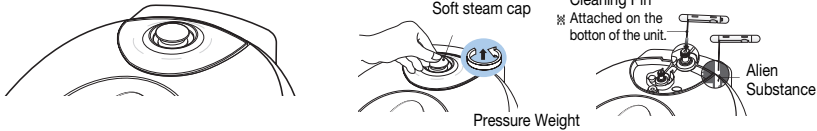

### How to disassemble the pressure weight

- ▶ Under the Lock/Unlock handle is locked (located on "Lock") turn the pressure weight counter-clockwise while pulling it up, and pull it out.
- ▶ Puncture the clogged valve hole with the cleaning pin and reassemble it by turning it clockwise.
- ▶ When the pressure weight is properly assembled, it can freely be turned.

## How to use cleaning pin and brush kit

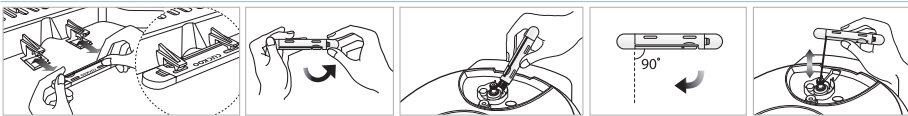

- 1 Separate cleaning pin Attached on the bottom of the unit from main body as shown in picture.
- 2 Separate cover as the arrow points.
- 3 Use brush kit. You can easily clean a drain use the ditch cap and tough pat to clean.
- 4 When using cleaning pin, pull out cleaning pin and make it meet at right angles.
- 5 Only use for the valve hole of the pressure weight.

## How to clean the soft steam cap

- ※ Do not touch the surface of the soft steam cap right after cooking. You can get burned.

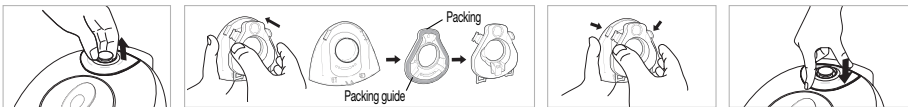

- 1 Detach the soft steam cap like the picture.
- 2 Press the hook in the back, and follow the arrow to detach and clean. Make sure you clean frequently with a sponge or a neutral detergent.
- 3 Assemble the went so that it fits into the groove perfectly.
- 4 After you attach the soft steam cap to fit into the groove, press "A" part firmly to assemble the soft steam cap into the product.

## How to clean dew dish



- 1 Separate dew dish
- 2 Separate the drain ditch cap by pushing it down.
- 3 Clean the drain ditch cap and dew dish with a neutral detergent.
- 4 Clean the drain ditch cap with brush kit.
- 5 Securely put in the dew dish after cleaning.

## When lid does not close perfectly

Do not try to close the lid by force. It can cause problems.



1. Check to make sure the inner pot is place correctly inside the main body.
2. To close the lid turn the handle to unlock, in shown in the picture on the right.



3. If there is excess steam inside the inner pot it might be difficult to lock the handle. Twist the pressure weight and allow the excess steam to release. Then try to turn the handle again.



# FUNCTION OPERATING PART / ERROR CODE AND POSSIBLE CAUSE

## Function Operating Part

### Preset/AUTO CLEAN Button

Used to preset preferred cooking time (Refer to page 28-29)  
When you use automatic steam cleaning function (Refer to page 18)

### Mode button

This function is used to customize individual (Refer to page 19-20) cooking preference, time-setting (Refer to page 14), voice volume setting (Refer to page 13), keep warm temperature setting (Refer to page 32), and power saving mode (Refer to page 33).

### Menu / Selection button

This function is used to select from among Glutinous Rice, High Heat Glutinous Rice, Mixed Rice, High Heat Mixed Rice, Sushi Rice, GABA Rice, High Heat GABA Rice, Black bean, Nu rung ji, Nutritious Rice, Nutritious porridge, Multi cook, Ferment Bread(Ferment), Ferment Bread(Baking), Auto clean and to modify preset time. See page. For setting selected action with mode button and setting gaba time multi-cook Bread(Ferment), Ferment Bread(Baking) time. See page.

### Keep Warm /Reheat button

Used to warm or reheat. (Refer to page 30)

### Pressure Cook / Turbo Button

This function is used to start cooking. (Refer to page 17)

### Display

### Cancel button

This function is used to cancel a selection or release remaining steam in the inner pot. (Refer to page 41) When using Power saving function. (Refer to page 33)

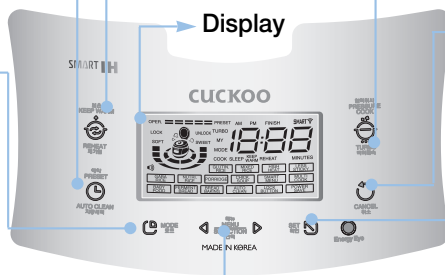

### Set button

This function is used to select a function or to button-lock function. (Refer to page 34)

- ※ If no operation is done while power cord is plugged, the system will be on standby mode as shown in the figure. (The menu on standby screen, time, voice and customized rice taste stage may differ depending on used configuration.)
- ※ If cancel button is pressed during cook, the rice cooker will go in standby mode.
- ※ Press the button until the buzzer sounds, Picture may vary depending on model.















<Standby condition screen>

## Error Code and Possible Cause

When the product has any problems or used it inappropriately, you can follow the below marks.

If error persistently shows up even in normal using conditions or after taking measure, inquire with customer service .

-  When the inner pot is not placed into the unit.
-  Problem on temperature sensor. ("E.." mark, "E\_P" mark, "E\_ε" mark blink.)
-  Problem on fan motor. "E\_F" marks blink.)
-  When pressing the Pressure Cook and Timer button, while the Lock/Unlock handle is on "Unlock"  
Turn the Lock/Unlock handle "Lock"
-  When boiling only water.
-  When setting preset time longer than 13 hours Set the preset time within 13 hours. (Refer to page 28-29)
-  It is appears on the display when you press Start button again, or if the cooking has finished and you've never ever turned the handle to "Unlock", It can be solved by turning handle to "Unlock" and then turn to "Lock".
-  Problem on micom power.
-  Problem on micom memory.
-  Problem on environment sensor.
-  This error messenger shows up when Pressure Cook or keeping warm/reheating button is pressed while separate cover is not mounted. Mount separate cover. Note: While keeping warm, alarm will sound and keeping warm and reheating do not work.
-  This code indicates the function of checking for abnormality of power of product.

# HOW TO SET CURRENT TIME / HOW TO SET OR CANCEL VOICE GUIDE FUNCTION



## How to set current time

ex)8:25am now

### 1 Press mode button once.

- ▶ Press mode button for more than 1 sec
- ▶ "Current time mode press yes button" after setting current time with selection button Menu/selection button blinks and Mode, Set and Cancel buttons turn ON.
- ▶ Colon mark (:) on the sec. screen is blinking once per second.

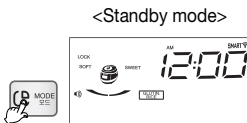

### 2 Set 8 o'clock and 25 minute as pressing menu/selection button.

- ▶ 1 min up "D" button  
1 min down "U" button
- ▶ 10 min up or down "D", "U" keep pressing.
- ▶ Careful of setting am,pm.
- ▶ In case of 12:00 it is 12:00 pm.

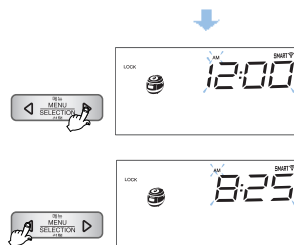

### 3 When finishing to set time you want, press "Set" button.

- ▶ If it is over 7sec without yes button, setting time will be canceled with voice, "it is canceled due to overtime".

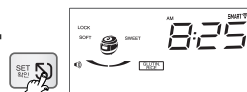

#### ■ About Lithium battery

- This product contains lithium battery for improving blackout compensation and time. Lithium battery lasts for 3 years.
- When current time is not displayed on the screen, it means the battery is exhausted. It should be replaced.

#### ■ What is blackout compensation

- This product remembers and maintains previous condition and processes. After finishing blackout, it operates immediately.
- If blackout happens during cooking, the cooking time will be delayed depending on blackout time.
- If the rice became cold because of blackout, warming will be cancelled.

#### ■ How to set current time during keep warming mode

1. Press Cancel button to cancel keep warm and then press Mode button over 1 time to set current time.
2. After setting time, press keep warm button to re-start keep warm.

## Voice guide volume control (The function which can control volume and cancel)

To enter this function, press Mode button 2 times. Mode button needs to be pressed for over 1 second at the first time.

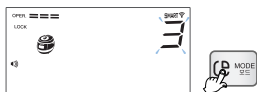

'3' sign is displayed when entered volume control mode by pressing Mode button 2 times.



If set value became '0' by pressing button, voice guide function is off.



Press button to set '5', that is the maximum volume sound.

When finish setting desired volume, press Mode button to store.

- ▶ Set button blinks and Mode, Menu/Selection and Cancel buttons turn ON.
- ▶ Keep the button pressed, and the button will turn to Continuous.
- ▶ Set to desired voice volume, and press Set button.



# NIGHT VOICE VOLUME REDUCTION/ VOICE SETTING FUNCTION

## Night Voice Volume Reduction

Set the function of night voice volume reduction, the function to reduce the volume of voice during night time (10:00PM-05:59AM) on need-to-do basis. This function works only during night time.

### ▶ How to set night voice volume reduction



Example) 60% of day time voice volume

OPER. =	Zero volume
OPER. ==	20% of day time voice volume
OPER. ===	40% of day time voice volume
OPER. ====	60% of day time voice volume
OPER. =====	80% of day time voice volume

Night voice volumes by the setting of process progress

1. Press mode button 10 times in standby status, and you will enter Night Voice Volume Reduction mode. When pressing mode button initially, press the button for 1 second or longer to enter Night Voice Volume Reduction mode.
2. When you enter Night Voice Volume Reduction mode, a voice comes up saying "You have entered Night/Voice Volume Reduction. Select or inactivate Night Voice Volume Reduction mode with 'Menu/Selection' button and press 'Set' button."
3. Press 'Menu/Selection' button, and as process progress bar change, voice volume will change. Select desired voice volume, and press 'Set' button.
4. Once process progress bar reach full condition through adjustment of 'Menu/Selection' button, a voice will come saying "The function of Night Voice Volume Reduction is inactivate." Inactivate the function by pressing 'Set' button.
5. If 'Set' button is pressed or no button is pressed for 7 seconds after you enter Night Voice Volume Reduction mode, the function will be inactivated along with voice "As set time is elapsed, the function is inactivated", and the system will be back to standby mode.

## Voice Setting Function

This function helps you select Auto voice for either a woman or English or Chinese's voice. With this function, you can set to your desired voice.

### ▶ How to set voice function



Example) When set to woman voice



Example) When set to English voice



Example) When set to Chinese voice

1. Press mode button 11 times in standby status, and you will enter Voice mode. When pressing mode button initially, press the button for 1 second or longer to enter Voice mode.
2. When you enter Night mode, a voice comes up saying "You have entered Voice function. Select or inactivate Woman, English and Chinese Voice mode with 'Menu/Selection' button and press 'Set' button."
3. After setting Auto voice with 'Menu/Selection' button, Woman voice or English or Chinese, and press 'Set' button.
4. If 'Set' button is pressed or no button is pressed for 7 seconds after you enter Volume, the function will be inactivated along with voice "As set time is elapsed, the function is inactivated", and the system will be back to standby mode.

# BEFORE COOKING RICE



## 1 Clean the inner pot and wipe the water on the inner pot with dry cloth.

- ▶ Use the soft cloth to wash the inner pot.
- ▶ Tough scrubber can make the coating come off.



## 2 Measure the amount of rice you want to cook using the measuring cup.

- ▶ Make the rice flat to the top of measuring cup and it is serving for 1 person. (ex: for 3 servings → 3 cups, for 6 servings → 6 cups)



## 3 Wash the rice with another container until the water becomes clear. (We recommend not to use inner pot for washing grains)

## 4 Put rinsed rice into the inner pot.

## 5 According to menu, adjust the water amount.

- ▶ For measuring, place the inner pot on a leveled surface and adjust the amount of water.
- ▶ The marked line of the inner pot indicates water level when putting the rice and water into inner pot together.
- ▶ About water scale
  - Glutinous rice, Turbo Glutinous rice, High Heat Glutinous Rice, Nutritious rice : Adjust waterlevel to the water scale for 'GLUTINOUS'. Glutinous rice / High Heat Glutinous rice can be cooked to max 10 servings, Turbo Glutinous rice / Nutritious rice to max 6 servings.
  - Mixed Rice, Turbo Mixed rice, High Heat Mixed Rice : Adjust water level to the water scale for 'Mixed Rice'. Mixed Rice / Mega Heat Mixed Rice can be cooked to max 8 servings, Turbo Mixed Rice to max 6 servings.
  - GABA Rice : Adjust water level to the water scale for 'GABA Rice'. GABA Rice can be cooked to max 6 servings
  - Soft Glutinous Rice : Adjust water level to the water scale for 'Soft GLUTINOUS'. Soft Glutinous Rice can be cooked to max 6 servings.
  - Nutritious porridge: Adjust water level to the water scale for 'PORRIDGE'. Nutritious porridge can be cooked to max 2 servings

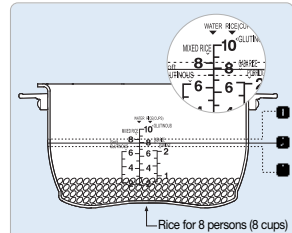

⌘ Cook in cereals menu, hard cereals like red-bean can be half-cooked depending on the kind of cereal.

1 When you want to cook the old rice or want the soft rice : pour more water than the measured scale

2 Glutinous Rice for 8 persons (8 cups) : Set the water to scale 8 of "GLUTINOUS"

3 For overcooked rice : pour less water than the measured scale

## 6 Put the inner pot into the main body and close the topcover.

Put the inner pot correctly.

- ▶ If there is any external substance on the temperature sensor or the bottom of the inner pot, wipe it off before putting the pot into the main unit.
- ▶ lid will not close if the inner pot is not placed correctly in the main body (Place the inner pot to the corresponding parts of the main body)



## 7 Connect power plug and turn the handle to "Lock"

- ▶ The lamp turning on means closed perfectly.
- ▶ If you press the cook button without setting the Lock/Unlock handle to "Lock", the cooker will not operate. You will hear "beep beep beep" sound and "E01" is shown in the LCD.
- ⌘ If you want to select another function while cooking, push cancel button.
- ▶ If 'E do' mark shows up in other instance, turn cover handle to "Open" direction, and turn it toward "Lock". Then the cooker will work normally. (The operation of cover lock sensing device can be checked.)

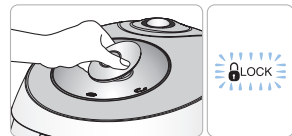

⌘ Note: This instruction is not applicable if cover handle is turned toward "Open" direction once or more after cooking was completed in previous cooking.



## FOR THE BEST TASTE OF RICE

### Cook tasty rice with Cuckoo pressure rice cooker

For the best taste of rice, check the following points carefully.

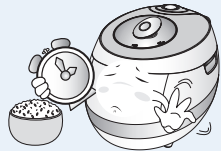
<p>Use the measuring cup!</p> <p>Pour the water until water level marking in the inner pot!</p>	<ul style="list-style-type: none"> <li>When measuring the rice, Use the measuring cup. (The amount of the rice may vary depending on the quality of the rice.)</li> <li>Place the inner pot on a flat surface and adjust the water to water level in the inner pot.</li> </ul>	<p>When the proportion between the amount of rice is not proper, rice can be crisp or hard.</p> 
<p>How to keep the rice</p>	<ul style="list-style-type: none"> <li>If possible, buy a small amount of rice and keep the rice some place where ventilates well and avoid a direct ray of light. It can prevent evaporation of rice moisture.</li> <li>If the rice has been unsealed for long, rice can be dry and stale. In this case, you should pour the half of water more. It's tastier.</li> </ul>	<p>When rice is too dry, it can be crisp even though measuring the amount of rice is accurate.</p>
<p>It's better to set the preset time shortly.</p>	<ul style="list-style-type: none"> <li>If possible, do not use the preset time function if rice is too dry and pour more water more.</li> </ul>	<ul style="list-style-type: none"> <li>If you set "Preset" over the 10 hours or "Preset" dried rice, rice can be crisp or half cooked. Even worse condition, rice can be cooked different tastes each level.</li> <li>If the preset time is longer, the melanoizing effect could be increased.</li> </ul>
<p>It's better to set the Keep warming time shortly.</p>	<p>It's better to set the keep warming in 12 hours.</p> 	<p>If rice is kept warm for a long period of time, rice color will change, and can cause odor.</p>
<p>Keep the product clean.</p>	<ul style="list-style-type: none"> <li>Clean the product often. (Especially clean the top of the cover for external substance.)</li> </ul>	<p>Wipe the lid heating part well for any rice or external substance.</p>





- 1 Choose menu with menu/selection button**
- Select button.
  - Each time "Menu" button is pressed, the selection switches in the sequential order, Glutinous Rice → High Heat Glutinous Rice → Mixed Rice → High Heat Mixed Rice → Soft Glutinous Rice → GABA Rice → High Heat GABA Rice → Nutritious Rice → Nutritious porridge → Chicken soup → Smart menu → Multi cook → Baby food → Ferment Bread(Ferment) → Ferment Bread(Baking) → Auto clean.
  - If the button is pressed, repeatedly, the menu switches continuously in sequential order.
  - In the cases of sushi, mixed rice, GABA and old rice, the menu remains memorized once each cooking is completed, so for continuous use of the same menu, no selection of menu is required.



ex) In case of selecting Soft Glutinous Rice.  
 ▶ You can hear a voice, Soft Glutinous Rice, when you cook Soft Glutinous Rice, automatic steam outlet operates while cooking.

- 2 Start cooking by pressing Pressure Cook/Turbo button.**
- You must turn lid handle to lock before cooking. Then press the pressure Cook/Turbo button.
  - Unless lid handle is not turned to close, you get alarm with "E01", and sound "turn lid handle to lock".

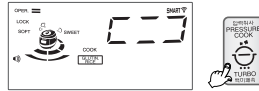

ex) In case of cooking Glutinous.

- 3 Cooking thoroughly**
- The cooktime remaining on the display is shown from cooking thoroughly. The cook time is different according to the menu.
  - Be careful not to burn yourself from the automatic steam outlet.

ex) In case of 14minutes left.

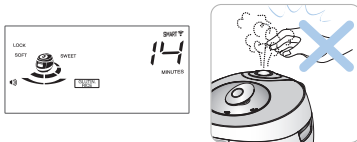

- 4 The end of cooking**
- When cooking is completed, warming will start with the voice "cuckoo completed glutinous".
  - When cooking ends, stir rice equally and immediately. If you don't stir rice at once and keep it stagnant, rice will go bad and smell bad.
  - If the lid handle is not working well, take out the steam completely out of inner pot by turning over pressure weight.
  - While cooking, do not press cancel button.

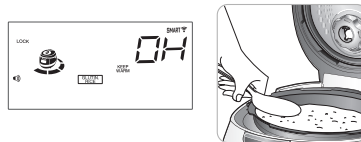

## Cooking time for each menu

Menu Class	Glutinous	Turbo Glutinous Rice	High Heat Glutinous Rice	Mixed Rice	Turbo Mixed Rice	High Heat Mixed Rice	Soft Glutinous Rice	GABA Rice	High Heat GABA Rice	Smart Menu	Nutritious Rice	Porridge	Chicken Soup	Baby Food/Fermentation/ Bread Baking/Multi Cook	Automatic Sterilization (Steam Cleaning)
<b>Cooking Capacity</b>	2 servings-10 servings	2 servings-10 servings	2 servings-10 servings	2 servings-8 servings	2 servings-6 servings	2 servings-8 servings	2 servings-6 servings	2 servings-6 servings	2 servings-6 servings	Please refer to app.	2 servings-6 servings	1 servings-2 servings	1 Chicken (About 1kg)	See detailed guide to cooking by the menus.	Up to water scale 2
<b>Cooking Time</b>	About 28 min-About 37 min	About 13 min-About 24 min	About 29 min-About 40 min	About 45 min-About 54 min	About 26 min-About 36 min	About 45 min-About 55 min	About 53 min-About 59 min	About 54 min-About 64 min	About 55 min-About 65 min		About 30 min-About 33 min	About 61 min-About 72 min	About 70 min		About 20 minutes

※ After cooking chicken soup and multi cook etc, the smell may permeate into the unit, use the Unit after cleaning the rubber packing and lid part according to page 10.

※ Cooking time by menus may vary to some degree depending on the using environment of the product.



# HOW TO COOK

## How to use the cooking menu

<b>Glutinous</b>	When you want to have sticky and nutritious white rice.	<b>Soft Glutinous</b>	When you want to have a little more sticky and nutritive white rice than Glutinous rice.
<b>Mixed /Brown</b>	This menu is used to cook a variation of mixed rice or brown rice.	<b>GABA Rice</b>	Used to cook germinated brown rice.
<b>Smart Menu</b>	With the NFC (Near field communication) function of the Smart Phone, the rice cooker can cook the new recipes, which are not pre-stored in the cooker, by transmitting the new recipes from the Smart Phone to the "Smart Menu" of the rice cooker.	<b>Chicken soup</b>	This menu cooks samgyetang automatically.
<b>Baby Food</b>	This menu is used to cook various baby foods by setting a time manually.	<b>Nutritious Rice</b>	Used to cook nutritious rice.
<b>Pomdige</b>	For cooking porridge.	<b>Multi Cook</b>	This menu is used to cook various dishes by setting a time manually.
<b>Automatic Sterilization (Steam Cleaning)</b>	This menu is used to eliminate small soaked after cooking or warming.	<b>Mega Heal (Glutinous/Mixed GABA Rice)</b>	Use when cooking more sticky and soothing Cooked Rice
<b>Mixed Rice Turbo</b>	<ul style="list-style-type: none"> <li>• If selected turbo mixed rice, total cooking time will be reduced. (It takes about 26minutes for cooking mixed rice for two people.)</li> <li>• Turbo mixed rice cooking lessens the quality of food, so only use for less than four people.</li> <li>• For better taste of cooked rice, cook rice in white rice turbo mode after macerating rice for 20 minutes or so before cooking.</li> </ul>		
<b>Turbo function for Glutinous Rice</b>	<ul style="list-style-type: none"> <li>• Pressing "pressure cook/turbo" twice will switch to quick cooking "Pressure Cook/Turbo" twice will switch to quick cooking and shorten the cooking time. (It takes about 14minutes when you cook the Glutinous rice for 2 persons.)</li> <li>• Use this turbo cooking function only for cooking rice for less than 4 persons. (The condition of the rice will not be good for more than 4 persons.)</li> <li>• The turbo cooking function is allowed up to 6 persons.</li> <li>• If you soak the rice in water for about 20minutes before cooking the rice and then cook the rice in turbo cooking course, the rice will taste good.</li> </ul>		

※ After cooking in white rice turbo mode or cooking of small serving, discard water. In case of small servings white rice turbo cooking, more water may be required than other menu.

※ Please refer to the cooking guide.

## How to use automatic sterilization (Steam Cleaning)

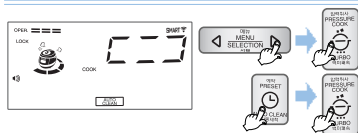

Put water until water scale 2, make sure to close and lock the cover.

Method 1, After choosing automatic cleaning menu by pressing "Menu/Select" button, and then press "Pressure cook/turbo" button.

Method 2. After choosing automatic cleaning function by pressing "Preset" button twice in standby mode, press "Pressure Cook/turbo" button.

## Melanoizing effect

The cooked rice can be light yellow at the bottom of the oven, because this product is designed to improve pleasant flavor and taste. Especially, melanoizing is more serious at the "Preset cooking" than just "Cooking".

It does not mean malfunction.

※ When mixing other rice with Glutinous, Melanoizing effect could increase more than "Glutinous cook" setting.

## Simple Soft Function

You can soak grains before stating cooking by setting a desired time with this function.

### ▶ Setting Method

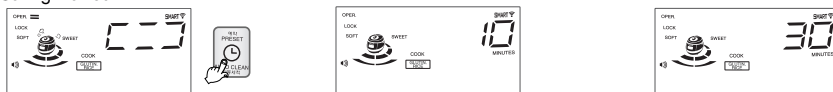

1. To activate the Simple Soft Function, "press /Auto Clan" button within 5 seconds right after. CUCKOO started the menu for Glutinous Rice, Mixed Rice, Turbo Mixed Rice, Sushi Rice, Nutritious Rice, Nu Rung Ji or Black bean.
2. To change the soaking time, press "press /Auto Clan" button in simple Soft Function: the time setting can change from 10 to 30 minutes, 60 minutes, and No Soaking Time.
3. If you do not press any button for more than 5 seconds while setting the soaking time, it will be automatically set back to the current soaking time. After the soaking time is over, the cooking will start.

※ Soaking time is counted by 1 minute unit.

※ If you unlock the Lock/Unlock Handle during the simple Soaking Function, the cooking will be canceled.

※ The longer the soaking time, the melanoizing effect.

# MY MODE (Cuckoo Customized Taste Function)



## What is “MY MODE”?

▶ Cuckoo’s patented technology based on variable circuit design. User can select the degree of “softness” and “glutinosity & tastiness” to meet a user’s desire.

## MY MODE Function

- ▶ Longer “SOFT” Time : rice becomes soft and glutinous. (selectable in 4 steps)
- ▶ Longer “SWEET” Time : rice becomes tastier(selectable in 4 steps) [melanoizing will occur]
- ▶ Both functions above can be selected simultaneously or separately

## How to Use “MY MODE”

To enter “Customized Rice Taste Setting Mode”, select the menu in which Customized Rice Taste is supported such as glutinous rice, High Heat glutinous, mixed rice, High Heat mixed rice GABA rice, High Heat GABA rice and press the mode button for 1 second or longer. Then, you are going to enter “Customized Rice Taste Setting Mode. Select the welling and heating stage with the Selection button, and press the Set button”.

※ The setting of figure below is based on glutinous rice menu.

### 1 “MENU”setting screen

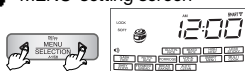

Select menu you want with menu/selection button and press the set button.

### 2 “MY MODE” setting screen



To enter Customized Rice Taste Setting Mode, select desire menu and hold the Mode button once for 1 second or longer.

### 3-1 Soft time control mode

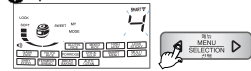

Select desired swelling time by pressing the button.

▶ Set button will blink, and Pressure Cook, Cancel and Menu/Select button will turn ON.

### 3-2 Sweet time control mode

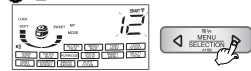

Select desired heating extension time by pressing the button, and press Set button.

▶ Set button will blink, and Pressure Cook, Cancel and Menu/Select button will turn ON.

※ Note : For 16 customized rice tastes, refer to the graph for 6 rice tastes. (See page 20.)

### 4 Setting the completed screen after

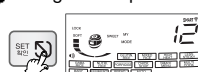

Set up desired customized rice taste. And press Pressure Cook. (If you press cancel or do not press a button within 7 seconds, the function will deactivate and return to the standby mode.)

## How to Use “MY MODE” II

You can customize your preference for cooked rice by selecting Customized Cooked Rice Taste mode or mode button. Each time you press Mode button, the major cooked rice taste will show up in the sequential order ‘Sticky Cooked Rice Taste -> Soft Cooked Rice Taste -> Soothing Cooked Rice Taste -> Soft and Soothing Cooked Rice Taste’.

※ The setting in the figure below is based on glutinous rice menu.

### 1 “MENU”setting screen

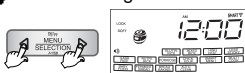

Select the menu you want with the menu/selection button and press the set button

### 2 “MY MODE” setting screen

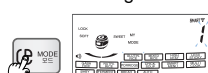

To enter Customized Rice Taste setting Mode, select desire menu and press Mode button once for 1 second or longer

### 3-1 Soft time control mode

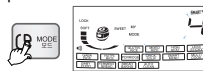

Press Mode button once, and the display will change as shown in the figure. At this time, Soft Cooked Rice Taste 4th Step will be selected.

### 3-2 Sweet time control mode

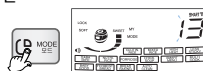

Press Mode button two times, and the display will change as in the figure. At this time, Soothing Cooked Rice Taste 4th Step will be selected.

### 3-3 Soft and Sweet Rice Mode

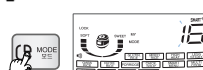

Press Mode button three times, and the display will change as in the figure. At this time, Soft, Soothing Cooked Rice Taste will be selected.

### 4 Setting completed screen after



Set up desired customized rice taste. And press Pressure Cook. (If you press cancel or do not press a button within 7 seconds, the function will deactivate and return to the standby mode.)



# MY MODE (Cuckoo Customized Taste Function)

## The display for My Mode



This is a graph that shows the flavors of 16 types of cuckoo custom-made rice

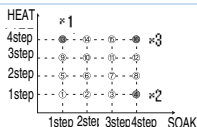

- \*1. The rice becomes solid and glutinous.
- \*2. The rice becomes soft and well-raised rice.
- \*3. The rice becomes soft and glutinous.

※ Note: Rice taste number from 1 to 16 will be displayed on the display window.

Shown in the figure above, the stage mark will show up on the display during setting swelling time, heating, and maintenance time. The mark will continue to show up during cooking, reservation, keeping warm, and reheating as well.

▶ Cuckoo customized taste function is applied to glutinous, mixed, GABA, old rice, Nu Rung ji.

※ Set-up times is stored until the next reset. No need to set-up at every cooking.

During cooking, warming and preset time cooking modes, "soak" and "heat" time cannot be readjusted.

- Cautions**
- 'MY MODE' function may influence scorching or cooking quality. Ensure that cooking time is not changed, by children.
    - ※ Default settings are "SOFT" 1 step, "SWEET" 1 step.
  - 'MY MODE' function may elongate cooking time according to the set-up time.
  - Scorching of rice may occur by longer "HEAT" Time.

## Cuckoo customized cooking function

While cooking you can control the heating temperature (both high and low) depending on, your preference.

Initialization is set up "OPER. === =" get step by step as the case may be.

- High step : for cooking cereals, old rice and soft-boiled rice.

- Low step : for cooking the year's crop of rice.

## How to use Cuckoo Customized cooking function

If you press the mode button 5 times, customized cooking function is setup. Select heating power by selection button. You can see all means with cuckoo customized cooking function on the display.

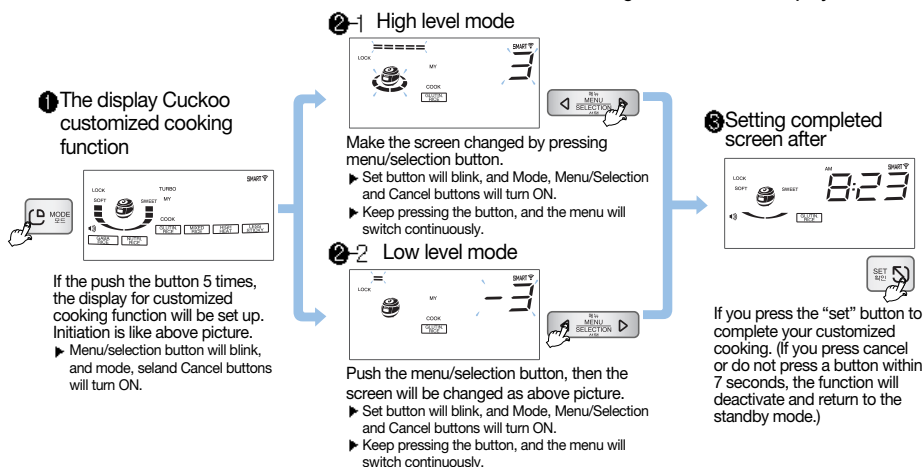

- 'Cuckoo customized cooking function' applies to Glutinous, High Heat Glutinous, Mixed Rice, High Heat Mixed Rice, Soft Glutinous Rice, GABA Rice, High Heat GABA Rice, Nutritious Rice collectively
- Set up the step of customized cooking function to taste. The scorch can occur when cooking in high level mode.
- Cook is subject to be set differently depending on the percentage of water content and the condition of rice.



# HOW TO USE “GABA RICE (Brown rice)”

## What is Germinated Brown rice?

- ▶ Brown rice has richer nutrients than polished rice. However, brown rice is rather tough and hard to be digested. By germination, the enzymes in the brown rice are activated, generating nutrients and become more digestible.

## Tips to Buy Quality Brown Rice

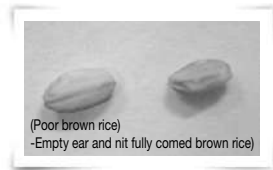
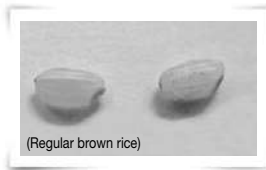
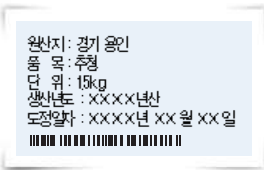

- 1 Check the dates of harvest and pounding.
  - ▶ The dates should be within 1year from harvest, 3 months from pounding.
- 2 Inspect rice with your eyes.
  - Check too see if the embryo is alive
  - Rice surface should be light yellow and glazing. Whitely stirred up surface, or darkish colored Brown rice is not suitable for a germination
  - Avoid fractured, not fully comed, or empty ear's. Empty ear's may generate odors during germination and and be bluish- nor comed Brown rice cannot be germinated.

## Features of Germinated Brown rice

Germinated Brown rice increases nutrients and enhances taste which is a weak point of brown rice. Germinated Brown rice also improves digestion.

- ▶ Taste will be greatly enhanced.
- ▶ Digestive and rich in nutrients.
  - Diabetic hormone is generated improving digestion.
- ▶ Good as a health food for children or adults.
  - Rich with dietary fiber.
- ▶ Germinated brown rice has rich GABA (Gamma Aminobutyric Acid)
  - GABA promotes metabolism in liver and kidneys, suppresses neutral fat, lowers blood pressure, promotes metabolism in brain cells - these effects have been proven by medical science.

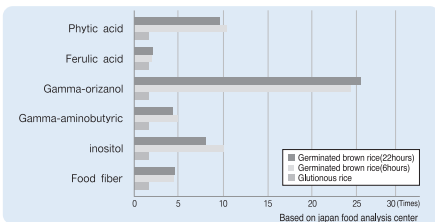

### < Comparison of Germinated brown rice's nutrition and Glutinous rice's (6 hours) nutrition. >

- ▶ Phytic acid 10.3Times
- ▶ Ferulic acid 1.4Times
- ▶ Gamma-orizananol 23.9Times
- ▶ Gammma-aminobutyric 5Times
- ▶ Inositol 10Times
- ▶ Food fiber 4.3Times



# HOW TO USE “GABA RICE (Brown rice)”

## Using “GABA RICE” Menu

### 1 In order to promote germination, soak brown rice for 16 hours in water.

Method of Pre-germination

- ▶ Put washed brown rice in an appropriate container, pour sufficient water to soak the rice.
- ▶ Pre-germination shall not exceed 16 hours. Make sure to wash rice clean with flowing water before using “GABA” menu. Be careful that hard washing may take off embryos which generate the germination.
- ▶ Unique smell may be generated according to the soaking time of pre-germination.
- ▶ When pre-germination has been completed, wash the rice and put in inner pot (Oven). Pour appropriated volume of water, and use “GABA RICE” menu.
- ▶ In summer or hot temperature environment odor may be generated. Reduce germination time and wash clean when cooking.

### 2 Set the Lock/Unlock handle at “Lock”, press “Menu/Selection” button to select “GABA RICE” Menu



※ First setting time 0H (0Hours)

- ▶ When the “GABA Rice” is selected, “0H” is indicated in the display.
- ▶ Set button will blink, and Mode, Menu/Selection, Cancel and Pressure Cook/Turbo buttons will turn ON.

### 3 Press “Set” and “Menu/Selection” buttons to set time.

▶ Menu/Selection button will blink, and Mode, Cancel and Pressure Cook Turbo buttons will turn ON.

1. Pressing “Menu/Selection” button changes germination time by 3hours.
  2. Pressing “Menu/Selection” button changes Germination time by 3hours.
  3. “GABA Rice” time by 0hours, pressing “Pressure Cook/Turbo” button will start cooking immediately.
- ✳ If GABA time is set “0” hours, pressing “Pressure Cook/Turbo” button will start cooking immediately. To cook without germination or cooking germinated Brown rice, set the time at “0”.

### 4 Press “Pressure Cook/Turbo” button.



※ 3 more hours for germination

- ▶ Pressing “Pressure Cook/Turbo” button will begin the “GABA Rice” process, after which. Cooking will begin immediately.
- ▶ During “GABA Rice” mode “” indicator will show the remaining time and will be displayed in minutes with the “3H” mark going around clock wise.

## Precautions for “GABA RICE” Cooking

- 1 If smaller germ is preferred, omit pre-germination process. Select “GABA RICE” menu, set-up appropriate germination time, and start cooking (nutrient ingredients do not vary significantly by the size of germ).
- 2 During hot seasons, longer germination time may generate odor. Reduce germination time.
- 3 GABA RICE cooking is allowed up to 6 persons.
- 4 City water can be used for germination. However, spring water is recommended. Germination may not be properly performed in hot or boiled water even after cooling.
- 5 Germination rate, germ growth may differ by the Brown rice type, condition or period of storing, etc.
  - Germinated brown rice is sprouted brown rice. Germination rate and growth may differ by the Brown rice type. The brown rice should be within 1 year from harvest, and not long since pounded.
- 6 In GABA RICE mode, preset on 3H may not be possible. If you want to preset the GABA RICE, set up ‘’.  
(See the page 26)
- 7 The taste of rice could be different as depending on a kind of brown rice. Use customized taste function or control the amount of water for your taste. (Refer to page 19-20)
- 8 Depending on the state of the surrounding environment or the condition/type of rice, the sprouts of rice may not be visible or appeared.



## How to use the preset timer of Multi-Cook

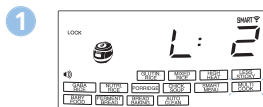

**Set the Lock/Unlock handle at " ● " (Lock) and press Menu/Selection button to select Multi-Cook.**

- ▶ SET button blinks, and Menu/Selection, Cancel, and Pressure Cook/Turbo buttons light.
- ▶ L:2 is indicated on the display when Multi-Cook menu is selected. (A voice comes up saying "Press Multi-Cook button".)

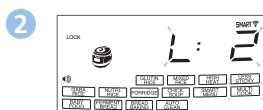

**Press SET button, and set heating stage with Menu/Selection button.**

- ▶ Menu/Selection button blinks and after that Cancel and Pressure Cook/Turbo buttons light. A voice comes up saying "Press SET button after setting heating stage for cooking with Selection button". (Please refer to the Cooking Guide for setting cooking time for each menu.)

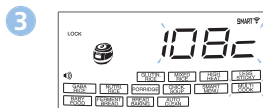

**Press SET button, and set cooking temperature with Menu/Selection button.**

- ▶ Menu/Selection button blinks and after that Cancel and Pressure Cook/Turbo buttons light. A voice comes up saying "Press SET button after setting cooking temperature with Selection button". (Please refer to the Cooking Guide for setting cooking time for each menu.)

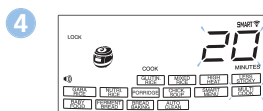

**Press SET button, and set cooking time with Menu/Selection button.**

- ▶ Menu/Selection button blinks and after that Cancel and Pressure Cook/Turbo buttons light. A voice comes up saying "Press SET button after setting cooking time with Selection button". (Please refer to the Cooking Guide for setting cooking time for each menu.)
- ▶ When you press the SET button, a voice will come up saying "Press Cook or Preset button".

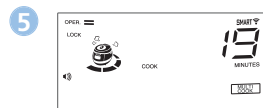

**Press Pressure Cook/Turbo button.**

- ▶ Pressure Cook/Turbo button blinks and after that Menu/Selection and Cancel buttons light. Press Pressure Cook/Turbo button and Multi-Cook mode begins. Once the Multi-Cook mode begins, the cooking icon is displayed along with the remaining time. A voice comes up saying "Multi-Cook CUCKOO starts cooking delicious meals".



# HOW TO COOK USING FERMENTATION/ BREAD BAKING

## Using Fermentation

### 1 Turn the top handle to “Lock”, press menu to select the “Ferment”.

- ▶ Set button will blink, and Menu/Selection, Cancel and Pressure Cooking buttons will turn ON.
- ▶ When the Fermenting Menu is selected, the display indicates cooking time to be 40 minutes.



### 2 Press “Set” button and “Menu/Selection” button to set fermentation time

- ▶ Available setting time is 5~120 minutes.  
(From 90 minutes or more onward, the fermentation time increases or decreases by 10 minutes)



### 3 Press “Pressure Cook/Turbo” button

- ▶ Press “Pressure Cook/Turb” button will begin the “Ferment” process, after which cooking will begin immediately.  
During “Ferment” mode, indicator will show the remaining time.



### 4 When first ferment is completed, press softly dough for remove gas and repeat process 2-3 for second ferment

- ▶ After second ferment, open the lid and make sure dough size is 1.5 to 2 times.

## Using Bread Baking

### 1 Press “Menu/Selection” button to select the “Bread Baking” mode.

- ▶ When selecting “Bread baking”, the display indicate cooking time to be 40 minutes.



### 2 Press “Set” button and “Menu/Selection” button to set baking time.

- ▶ Available setting time is 1~80 minutes.
- ▶ Set the baking time depending on the fermentation state and the capacity of the dough.



### 3 Press “Pressure Cook/Turbo” button

- ▶ Press “Pressure Cook/Turb” button will begin the “Bread Baking” process, after which cooking will begin immediately.  
During “Bread Baking” mode, indicator will show the remaining time.



- ※ When the “Bread Baking” process is complete. Immediately remove the bread from inner pot
- ※ After the “Bread Baking” is complete, the bread is hot and you should be careful.



# HOW TO COOK USING FERMENTATION/ BREAD BAKING



▼ If there is a problem of fermentation / bread baking, check the following details.

	Case	Check point	Do the following
<b>D O U G H</b>	When dough is not inflated	<ul style="list-style-type: none"> <li>• Is capacity of the material accurate?</li> <li>• Do not have the dough is elastic with flaccid?</li> <li>• Is the surface of the dough smooth and elastic, and transparent?</li> <li>• Does fermentation time is long or short?</li> </ul>	<ul style="list-style-type: none"> <li>• Check the volume of the ingredients and knead the dough well.</li> </ul>
<b>B A K E D</b>	When bread is small and stiff.	<ul style="list-style-type: none"> <li>• Capacity of the material, the time set correctly?</li> </ul>	<ul style="list-style-type: none"> <li>• follow the correct ingredient volumes and directions for fermentation and baking time.</li> </ul>
	When bread is rough and crunch.	<ul style="list-style-type: none"> <li>• Fermentation time and kneading time set correctly?</li> </ul>	
	When bread was undercooked.	<ul style="list-style-type: none"> <li>• Did you set short fermentation time or baking time?</li> </ul>	
<b>B R E A D</b>	When bread was overcooked.	<ul style="list-style-type: none"> <li>• Did you set long fermentation time or baking time?</li> </ul>	<ul style="list-style-type: none"> <li>• When the second fermentation is complete, the dough should be left in the middle of the inner pot. Extend their baking time.</li> <li>• When the “Bread Baking” process is complete. Immediately remove the bread from inner pot</li> </ul>
	When the baked color of the Underside of the bread is not appered.	<ul style="list-style-type: none"> <li>• Did you put the dough in the middle of inner pot. Did you set short baking time?</li> </ul>	
	When the bread is too sticky and wrinkled.	<ul style="list-style-type: none"> <li>• Did you remove basket bread immediately?</li> </ul>	



# HOW TO PRESET TIMER FOR COOKING

## How to preset timer for cooking

How to use timer function

### 1 Check if the current time and the menu are correct.

- ▶ Refer to page 13 for the time setting.
- ▶ If the current time is not set correctly, the presetting time will also be incorrect.
- ▶ Make sure to select AM or PM correctly.



### 2 Turn the Lock/Unlock handle to the lock position and a lock icon will be displayed on the screen. Then press the "preset" button.

- ▶ To activate Preset 1, press the "preset" button once. To activate Preset 2, press the "preset/timer" button twice.
- ▶ Factory Set Configurations-Preset 1 : Preset at 6:30 am, Preset 2 : Preset at 7:00pm. If you want to use these times, select Preset 1 or Preset 2.
- ▶ If the lock/unlock handle is not in the locked position then you will not be able to program or use the preset function.
- ▶ When you press the "preset" button, the preset time will be displayed, and the Preset 1 & Preset 2 signs will be blinking.
- ▶ Gaba menu, you have to select "QH" in order to use the preset timer function.
- ※ When it is in keep warm mode, press cancel to exit keep warm mode, then select your desired preset time.

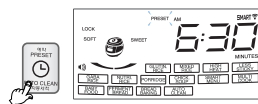

### 3 Select menu with "Menu/Selection" button.



### 4 Preset the time.

- ▶ In case of setting up timer while warming, increases by 10min when you press "▲" button.
- ▶ Please set up timer after canceling warming, decreases by 10min when you press "▼" button

If you keep on pressing either button, It can be changed continually.

※Please be careful no to change from AM to PM.

- ▶ Then press the "Set" button to program your desired time.

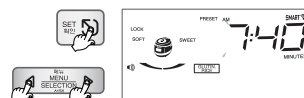

### 5 Press "Pressure Cook" button.

- ▶ It says that preset cook for glutinous is booked Preset cook will be completed at the timer.
- ▶ Once cook is completed with preset time, preset time is stored in the memory.
- ▶ Don't need to set up time again.
- ※ If a small amount of rice is cooked, it could be finished earlier than time you programmed it.

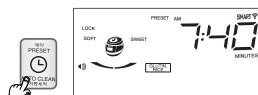

# HOW TO PRESET TIMER FOR COOKING



## Precautions for preset cooking

### 1 In case of preset cooking

- ▶ If the rice is old and dry, the result may not be good.
- ▶ If the rice is not well cooked, add more water by about half-scale.
- ▶ If the preset time is longer, melanization could be increased.
- ▶ Rinsed rice adds precipitated starch, Preset Cook may cause scorching.  
To reduce scorching, cook washed rice by rinsing in running water or reduce cooking amount.

### 2 The change of preset time

- ▶ Press “cancel” button for more than 2 seconds and restart it to change the preset time.

### 3 If the preset time is shorter than cooking time, cooking will immediately begin.

- ▶ If set time is shorter than preset time, cooking will immediately begin.

### 4 In case the preset time is over 13 hours.

- ▶ “13Ho” will be displayed and the preset time will be changed to 13 hours automatically.  
ex) If cooking is preset to AM07:00 of the following day at PM5:00 of the day, where preset time is 14 hours, “13Ho” will be displayed, and preset time automatically changes to AM06:00. (Preset time is 13 hours)
- ※ If the preset time is over 13 hours, it can cause bad smell. The limited preset time is set up less than 13 hours because the rice spoils easily during the summer time.
- ※ When you want to finish presetting P.M 12:00, preset P.M 12:00.
- ※ Use this function when you want to finish cooking between 1 hour to 13 hours based on the preset time.
- ※ If you press the set button to check the present time during the preset cooking function, the preset time will be displayed for 2 second.

## Possible time setting for each menu

Menu Class	Glutinous Rice	MegaHeat Glutinous Rice	Mixed Rice	MegaHeat Mixed Rice	Soft Glutinous Rice	GABA Rice	MegaHeat GABA Rice	Nutritious Rice	Boby Food	Chicken Soup	Nutritious porridge	Multi Cook	Ferment Bread baking	Automatic Sterilization (Steam Cleaning)
Possible time Setting	From (42minutes +My mode) to 13hours	From (45minutes +My mode) to 13hours	From (59minutes +My mode) to 13hours	From (60minutes +My mode) to 13hours	From 64minutes to 13hours	From (69minutes +My mode) to 13hours	From (70minutes +My mode) to 13hours	From 38minutes to 13hours	From (1minutes +My mode) to 13hours	From 75minutes to 13hours	From 77minutes to 13hours	From (1minutes +My mode) to 13hours	From (1minutes +My mode) to 13hours	From 25minutes to 13hours



# HOW TO USE PRESET REHEATING FUNCTION

## How to use Preset Reheating function

- ▶ Use this function when the cooked rice is not kept warm in the rice cooker but you still want to enjoy a hot meal at your convenience.
- ▶ It takes three hours before it's fully warmed up: Please use the function at least three hours before you enjoy your meal.

For example, if it is nine o'clock in the evening and you want to have warm breakfast at six thirty the next morning:

### 1 Make sure that the current time is correct

- ▶ See Page 13 for how to set the current time.
- ▶ Please make sure that the current time is correct so that the reheating process ends on time.
- ▶ Do not get confused between morning and afternoon.



### 2 Set the Lock/Unlock handle at "○" (Lock) and press Preset/Auto Clean button when the Lock icon is displayed.

- ▶ A voice will come up saying "Select menu with Preset and Selection button and press SET button."
- ▶ Menu/Selection, Keep Warm/Reheat buttons blink and after that Preset/Auto Clean, Set, Cancel and Pressure Cook/Turbo buttons light.
- ▶ Please make sure that the Lock/Unlock handle is locked properly before using the Preset function.

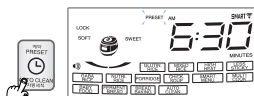

### 3 Press the Keep Warm button and Preset Reheating mode begins.

- ▶ A voice will come up saying "Please set the completion hour of reheating using Preset Reheating and Selection button and then press Keep Warm button."
- ▶ Menu/Selection button blinks and after that Keep Warm/Reheat, SET and Cancel buttons light.
- ▶ The Preset time is set to 06:30 AM when the product is delivered from the factory. If you want to preset reheating to this hour, it is not required for you to set the time.

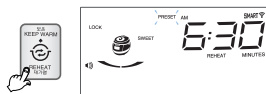

### 4 Press the Menu/Selection button to preset the completion hour of reheating.

- ▶ Keep Warm/Reheat button blinks and after that Menu/Selection, SET and Cancel buttons light.
- ▶ The completion hour is increased by 10 minutes each time you press the "▷" button.
- ▶ The completion hour is decreased by 10 minutes each time you press the "◁" button. If you keep pressing the button and the time changes continuously (repetition is allowed).

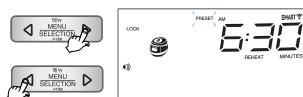

※ Do not get confused between morning and afternoon.

### 5 Press the SET button.

- ▶ A voice will come up saying "Press the Keep Warm button."
- ▶ Keep Warm/Reheat button blinks and after that Menu/Selection, SET and Cancel buttons light.

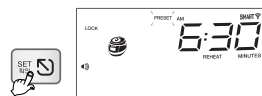

### 6 Press the Keep Warm/Reheat button.

- ▶ A voice will come up saying "Reheating will be completed today/tomorrow at 00, 00:00 AM/PM."
- ▶ Reheating is completed as scheduled.
- ▶ The cooker memorizes the hour that you have preset: You may press the Warming/Reheating button directly without having to preset the time again from the beginning.



# HOW TO USE PRESET REHEATING FUNCTION



## Precautions for preset reheating

### 1 In case of preset reheating

- ▶ When leaving cooked rice at ambient temperature for a prolonged period of time, moisture is evaporated from cooked rice. In such a case, the reheating preset may cause dehumidifying or melanosis (slightly burnt) of cooked rice.
- ▶ If there is an excessive amount of cooked rice in the pot, it may not sufficiently be reheated. It is recommended to set reheating for no more than six people (approx. half of the inner pot).
- ▶ Reheating of cold- or frozen-stored cooked rice may cause insufficient heating, dehumidifying or melanosis (slightly burnt) after completion of reheating.
- ▶ Put cold-stored cooked rice into the inner pot, beat rice with a scoop, and then reheat rice.
- ▶ Reheating of frozen-stored cooked rice shall be performed only after thawing the rice.

### 2 Changing preset time

- ▶ Press "cancel" button for more than 2 seconds and restart it to change the preset time.

### 3 If the preset time is beyond the available range

- ▶ If the preset time is shorter than the available range (3 hours), reheating will begin immediately.

### 4 In case the preset time is over 13 hours.

- ▶ "13H0" will be displayed and the preset time will be changed to 13 hours automatically. If cooking is preset to AM07:00 of the following day at PM5:00 of the day, where preset time is 14 hours, "13H0" will be displayed, and preset time automatically changes to AM06:00. (Maximum preset time is 13 hours)
- ※ If the preset time is over 13 hours, it can cause bad smell. The limited preset time is set up less than 13 hours because the rice spoils easily during the summer time.
- ※ When you want to finish presetting P.M 12:00, preset P.M 12:00.
- ※ Use this function when you want to finish cooking between 1 hour to 13 hours based on the preset time.
- ※ If you press the set button to check the present time during the preset cooking function, the present time will be displayed for 2 seconds.



# TO KEEP COOKED RICE WARM AND TASTY

## Having a meal

- ▶ If you want to have warm rice, press the “Keep warm/Reheat” button. Then “Reheat” function will be started and you can eat fresh rice in 9 minutes.
- ▶ To use reheating in standby status after power is applied, turn lid combining hand grip to Locked location, press Reheat/Keep button, and the cooker will convert to Heat Preservation mode. Here press Reheat/Keep warm button once more.

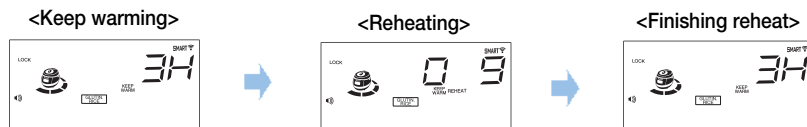

34 indicates the time elapsed as warming time.

The lamp blinks and "09" indicator will show the reheat remaining time displayed in minutes with the mark going around clockwise.

When the reheat finishes with the beep sound, keep warming function will be operated and show the time elapsed.

※ If you change the present time during warming, see the page 13.

- ▶ The frequent use of the “Reheat” function may cause the cooked rice to be discolored or dried. Use it once or twice per day.
- ▶ If a separate heating appliance or gas burner is used to cook rice, put the cooked rice into the cooker and press the “Keep Warm/Reheat” button to keep the rice warm. At this time, “09” is shown on the display. (Like this, transferring hot rice to a cold cooker may cause the rice to be discolored or develop an odor)
- ▶ After 24 hours of heat preservation, the lamp of heat preservation time lapse blinks, indicating that long time has passed in heat preservation condition.
- ▶ In case the lid combining hand grip is in open status during heat preservation, the cooker does not go for reheating. For reheating, lock the lid combining hand grip to (Locked) position, and then press Keep warm/reheat button.
- ▶ If the lid combining hand grip is turned to open status during reheating, function display will show “E0!”. At this time, reheating will be cancelled, and heat preservation will proceed.

## Simple Soft Function

It will be hard to open the lid during warming or right after it has finished cooking. So push the pressure weight to the side and allow the steam to release.

Make sure the handle is in the “Lock” position during warming or reheating.

It is recommended to evenly stir the cooked rice after cooking. The rice taste is improved. (For a small quantity of rice, pile up the rice on the center area of the inner pot to keep warm)

Do not keep the scoop inside the pot while warming the rice. When using a wooden scoop it can create serious bacteria and odors.

It would be better to warm the rice for less than 12 hours because of odors and color change.

The cooked rice, which cooked by pressure cooker is more prone to changing color than the rice cooked by general cooker.

During warm mode, the rice can arise and turn white and rise. In this case, mix the rice.

The mixed and brown rice cannot be in such good condition as white rice while in warm function due to their characteristics. Therefore do not keep mixed and brown rice in function for a long period of time.

Do not mix small amount of rice or leftovers with the rice under keeping warm. Doing so may cause an odor. (Use a microwave oven for the cold rice.)

# TO KEEP COOKED RICE WARM AND TASTY



## Controlling method of warming temperature

If the temperature in the oven is not proper, it will smell bad and the color of the rice will change so make sure to adjust the temperature.

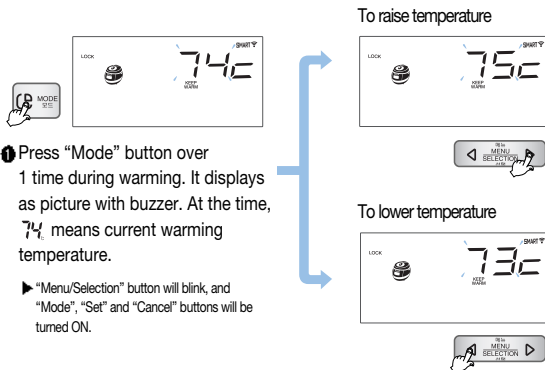

- 1 Press "Mode" button over 1 time during warming. It displays as picture with buzzer. At the time, 74 means current warming temperature.

▶ "Menu/Selection" button will blink, and "Mode", "Set" and "Cancel" buttons will be turned ON.

※ Note: The reference temperature programmed when the product is shipped may differ from the Instruction.

- 1 Press "Menu/Selection" button to change the temperature as 74 → 75 → 76 → 77 → 78 → 79 → 80.

▶ "Set" button will blink, and "Mode", "Menu/selection" and "Cancel" button will be turned ON.

▶ To switch the functions continuously, keep pressing the button.

- 2 After setting temperature, press "Mode" select button. Preset temperature will be stored with buzzer sound. (If will be cancelled once press "Cancel" button or after 7 seconds without pressing any button)

- 2 Press "Menu/Selection" button to change the temperature as

74 → 73 → 72 → 71 → 70 → 69.

▶ "Set" button will blink and "Mode", "Menu/Selection" and "Cancel" buttons will be turned ON.

▶ To switch the functions continuously, keep pressing the button.

## Change of temperature

If you want to change cooking temperature in the standby mode, press "Mode select" button over 2 seconds, and press it 2 more times. You can change cooking temperature.

## How to operate My Mode function.

Use it while opening the lid when there is too much water or rice becomes too soft.

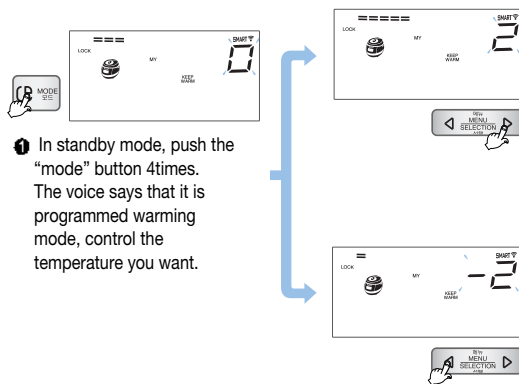

- 1 In standby mode, push the "mode" button 4 times. The voice says that it is programmed warming mode, control the temperature you want.

- 1 Press "Menu/Selection" button to change as the picture (up)

▶ "Set" button will blink, and "Mode", "Menu selection" and "Cancel" button will be turned ON.

▶ To switch the functions continuously, keep pressing the button.

- 2 Select the menu you want, then the press the "Mode" button and set-up time will be automatically entered with a buzzer. (If you press the "Cancel" button or do not press a button within 7 seconds, the function will be cancelled and returned to standby mode.)

- 2 Press "Menu/Selection" button as the picture (down)

▶ "Set" button will blink and "Mode", "Menu/Selection" and "Cancel" buttons will be turned ON.

▶ To switch the functions continuously, keep pressing the button.

1. If too much water is spilled out when you open the lid : Press "Menu/Selection" button to raise the setting mode.
2. If the edge of rice is too soft : Press "Menu/Selection" button to reduce the setting mode.



## TO KEEP COOKED RICE WARM AND TASTY

### How to activate “Sleeping” mode.

When keeping rice warm for a long time, set up the temperature low to prevent the following quality of rice: smelly, dry, change of color; from PM10:00 ~ AM 04:00.

#### ► How to set up



1. Hold “mode” button for one second, then press the “mode” button 6times to set up sleeping mode. If sleeping mode is not shown, keep on pressing the “mode”button until it is heard or displayed.
2. When you are in sleeping mode, it says “After selecting or canceling sleeping mode, press the set button.” At this time, “Menu/Selection”button will blink, and the “Mode”, “Set”, and “Cancel”button will turn on.
3. Press the “Menu/Selection” button until you hear or see “Sleeping mode”, then Press “set”button. You will see nothing surrounding the rice cooker on the screen.
4. This function must be activated by the user depending on necessity

#### ► How to release



1. Hold “Mode” button for one second, then press the “mode” button 6times to set up sleeping mode. If sleeping mode is not shown, Keep on pressing the “mode” button until it is heard or displayed.
2. When you are in sleeping mode, it says “After selecting or canceling sleeping mode, press the set button” At this time, “Menu/Selection” button will blink, and the “Mode”, “Set”, and “Cancel” button will turn on.
3. Press the “Menu/Selection” button until you hear or see “Sleeping mode”, then Press “Set” button. You will see nothing surrounding the rice cooker on the screen.
4. In the Sleep/Warm mode, if you press “Cancel” button, the Voice message will state: “Time is over. The function setting has been canceled.” If no button is pressed for more than 7 seconds, You'll return to the Standby mode.

- If you need to keep the rice warm during sleeping, do not use this function. This function makes the rice cooler than normal. In summer, the rice can be spoiled and may smell bad because of high temperature. If possible, do not use the “Custom-made warming” mode while sleeping.
- This function is set up as cancel state.

### When odors are rising during the warming mode

- Clean the lid frequently. It can cause bacteria and odors.
- Even though exterior looks clean, there might be germs and it can cause odor so please be sure to use automatic sterilization (steam cleaning) menu for cleaning. Clean the inner pot completely after automatic cleaning function is done. (refer to 18)
- After you cook soups and steamed dishes, clean the inner pot properly to prevent rice from smelling.



# HOW TO USE POWER SAVING/ ENERGY EYE FUNCTION



## What is power saving in “Standby” mode?

If power cord is not unplugged, little bit of electricity will be still wasted. It is called standby electric power. The power saving of "Standby" mode is technology which minimizes this electricity consumption.

### Manual Method

#### ► How to start power saving

When Cancel button is pushed for 2 seconds at waiting state, Saving power function is set up.



#### ► How to end power saving

Method 1) Push any button then it will be returned to waiting mode.

Method 2) If lid handle is turned to open or close, power saving mod will be canceled and back to waiting Mode.



### Automatic Method

If the standby time is chosen as number other than “0” at the automatic power saving mode, the automatic saving power function will be operative.

If you move lid handle or push any button before passing waiting time, the waiting time which is reduced will go back to the setting.

#### ► How to original setting

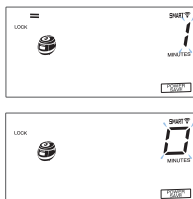

1. If you push “mode” button 7 times at the standby state, automatic power saving mode is set up.
2. When automatic power saving mode is set up, it says that this is automatic power saving mode. Press the “Set” button after selecting waiting time.
3. If you select “0” minute with “Menu/ Selection” button, Automatic saving will be canceled. After setting up waiting time you want, press the “Set” button.
4. Without pressing any button within 7 seconds or pushing “Cancel” button, Automatic power saving function will be canceled and go back to waiting mode.

## Energy Eye function

The luminance sensor automatically recognizes ambient brightness during standby, cooking, warming and preset timer for minimizing power consumption of the product. If you want the power saving mode to start when it's darker than the current level(Step 2), set the mode to Step 1. If you want the mode to start when it's brighter than the current level, set the mode to Step 3. (The power saving mode of CUCKOO is set to Step 2 at the factory.)



(When selecting Energy Eye function)

(When deactivating Energy Eye function)

1. Press the Mode button 12 times in standby status and you will enter the Energy Eye mode. (Please make sure that you press the Mode button for a second or longer in the beginning.)
2. When you enter the mode, a voice comes up saying "You have entered the Energy Eye mode. Please select or deactivate the Energy Eye mode with Selection button and press SET button." After that, Menu/Selection button blinks and Mode, SET and Cancel buttons light.
3. Each time you press the Menu/Selection button, the Energy Eye shifts from OFF to Step 1 to Step 2 to Step 3. When OFF is displayed, a voice comes up saying "Energy Eye function is deactivated." The Set button blinks and Mode, Menu/Selection and Cancel buttons light.
4. After selecting your preferred step, please press the SET button. A voice will come up saying "Energy Eye setting has been completed" and your step will be stored.
5. If will be cancelled if you press the “Cancel” button or after 7 seconds without pressing any button. In this case a voice will come up saying "Time exceeded, the mode will be canceled".



# HOW TO USE POWER SAVING/LOCK BUTTONS/ REMAINING COOKING TIME DISPLAY MODE

## Display Lighting/Power-Saving Mode

This mod adjusts the brightness of the display during cooking, warming or reservation cooking.

### ► How to set and unset the mode



1. In the Standby mode, press the Mode button 9times to activate the Display Lighting/Power- Saving mode. (Press the Mode button for more than 1 second to enter into the Display Lighting /Power-Saving mode)
2. When the Display Lighting /Power-Saving mod starts, a Voice message will state “Set or cancel the Display Lighting Function by pressing the Selection button. Then, please press the Display “At that moment the Menu/Selection button will be switched off and Mode, Set and Cancel button will appear.
3. When you press the Menu/Selection button, a Voice message will give one of these two statements : The Display the Lighting/ Power –Saving Function is selected. Please, press the Set button. “or” The Display Lighting/ Power–Saving Function is canceled. Please press the Set button. “The Set button will then disappear and the Mode, Set and Cancel button will be turn on.
4. Press the Set Button and the Display Lighting/Power –Saving Funding will start with a Voice message stating “The Display Lighting/Power –Saving Function has been set.”
5. In the Display Lighting/Power- Saving mode, press the Cancel button or do not press any button for more than 7 seconds. The setting will be canceled and you return to the Standby mode with a Voice message stating “Tim is over. The function has been canceled.”

## How to Set “LOCK BUTTONS”

Lock can be set for touch button to prevent accidental touch during cleaning or by children.

### ► Setting Method

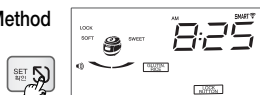

1. Button will be locked if “Set” button is pressed for 3 seconds or longer during cooking, presetting, warming, reheating or in standby condition.

2. When button is locked, a voice will sound saying “Button lock is selected”. At this time, button lock is displayed on the screen.

### ► How to set and unset the mode

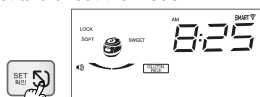

1. To cancel button lock, press ”Set” button for 3 seconds or longer on locked the button.

2. “Lock” sign on the display disappears when button lock is cancelled, a voice will be saying “Button lock is cancelled”.

※ Note: Any button other than “Set” button is pressed while button lock is set, buzzer will sound.

※ Note: Desired function can be set after cancelling button lock is set, buzzer will sound.

※ Note: Button lock function is cancelled automatically when the power is off even though the button lock function is already set.

## Remaining Cooking Time Display Mode

This mode sets on or off the remaining cooking time display which appears periodically during the cooking.

(The displayed remaining cooking time may vary from the actual one depending on the cooking volume and process.)

1. In the Standby mode, press the Mode button 9 times to activate the Remaining Cooking Time Display mode. (Press the Mode button for more than 1 second to enter into the Remaining Cooking Time Display mode.)

2. When the Remaining Cooking Time Display mode starts, a voice message will state “Set or cancel the Remaining Cooking Time Display Function by pressing the Selection button.”

3. When you press the Menu/Selection button, a voice message will give one of these two statements: “The Remaining Cooking Time Display Function is selected. Please, press the OK button.” or “The Remaining Cooking Time Display Function is canceled. Please press the OK button.” The OK button will then disappear and the Mode, Menu/Selection and Cancel button will be turned on. After selecting either mode, press the OK button.

4. In the Remaining Cooking Time Display mode, press the Cancel button or do not press any button for more than 7 seconds. The setting will be canceled and you return to the Standby mode with a voice message stating “Time is over. The function has been canceled.”



※ Remaining Cooking Time Display mode set off



※ Remaining Cooking Time Display mode set on

# HOW TO USE THE NFC FUNCTION



## App installation and activation

You can interface the product with your smart phone when you download and install CUCKOO Smart Rice Cooker application from Android Play Store.

### ► How to use the NFC function

1. Please see the user's manual of your smart phone if the phone supports the NFC function.
2. NFC function of smart phone is supported only by Android OS version 2.3.3 or higher only.
3. If you are new to the NFC function, please refer to the NFC setting instruction below:

### ► App installation

1. You can simply touch your smart phone on the NFC icon of your product to install the application from the Google Store.
2. Search CUCKOO on Google Store, and download and install the application.

## How to set NFC function (for Galaxy S3)

Setting method may slightly vary among smart phone models. See the user's manual of your smart phone.

### 1 Settings

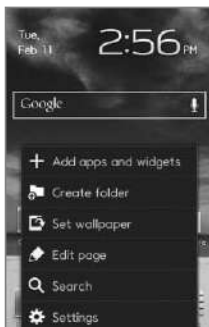

### 2 More Settings

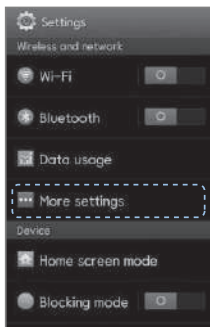

### 3 NFC function ON

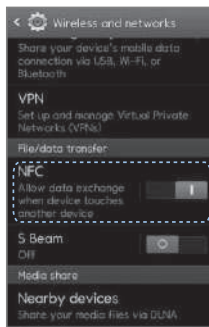

### 4 Read and Write/P2P, Android function NO

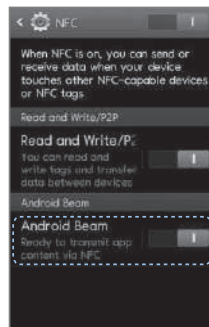

## How to touch



1. Hold the smart phone as shown below, and touch the antenna of your smart phone on NFC icon of your product for 2-3 seconds.
2. NFC functions only when the screen of the smart phone is displayed as shown below.
3. It does not function properly when the screen of your smart phone is turned on, or locked.
4. Please make sure the antenna touches the NFC icon properly so that they communicate without any problem.
5. Once they communicate properly, a message window is displayed to indicate the transmission has succeeded.
6. Location of the NFC antenna varies among smart phone models. See the user's manual of your smart phone to check the location of the NFC antenna.
7. NFC transmission speed may vary among smart phone models.



# HOW TO USE THE NFC FUNCTION

## How to select your product model after loading the application.

1 Start the application.



2 Choose between Automatic and Manual selection.

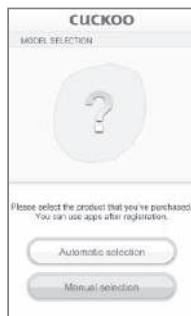

3-1 Automatic selection



3-2 Manual selection

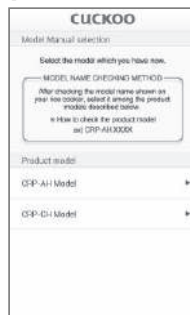

4 The app is executed.



## Automatic cooking

It is allowed to perform cooking function through interface of CUCKOO and the smart phone.

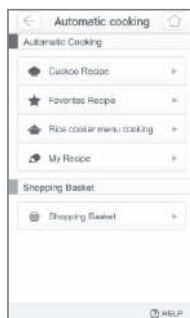

1 CUCKOO recipes

The NFC technology supports cooking based on the additional recipes transmitted to Smart Menu of your product. Transmitted recipes are stored in the Smart Menu of your product. (The Smart menu has Black bean as its default recipe.)

2 Favorite recipes

When Favorite button on the CUCKOO recipes is clicked, the recipe is saved as a favorite recipe.

3 Rice cooker menu

It allows to easily set various menus and settings of the rice cooker with the smart phone, and conveniently cook the menu through the NFC function.

4 My recipes

You can save your own recipes in your smart phone, and conveniently cook according to the recipe simply by touching it to your product.

5 Shopping cart

List of ingredients for recipes is stored in the shopping cart of CUCKOO recipes.

# HOW TO USE THE NFC FUNCTION



## How to choose a recipe

### 1. Search recipe

- ① Select search bar
- ② Type in recipe and search
- ③ Confirm the recipe



### 2. Search by the types of recipe

- ① Select automatic cooking
- ② Select cuckoo recipe
- ③ Select recipes
- ④ Select Steam dish

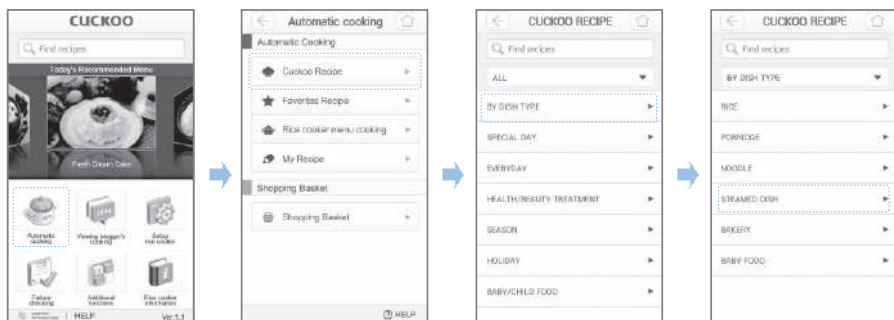

- ⑤ Select Multi-flavor glutinous rice

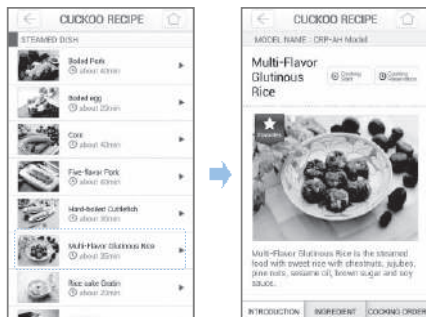



# HOW TO USE THE NFC FUNCTION

## How to choose a recipe

### 3. Search by the conditions

#### 1 Select automatic cooking



#### 2 Select cuckoo recipe

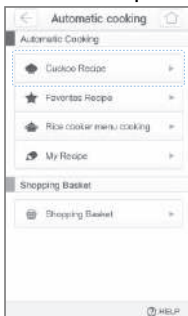

#### 3 Select special day

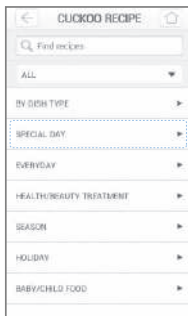

#### 4 Select treatment for seniors

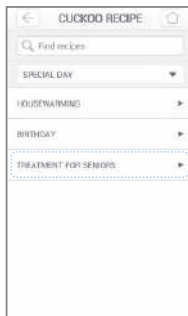

#### 5 Select Multi-flavor glutinous rice

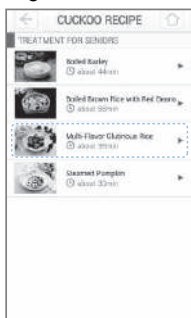

## How to start cooking after selecting your preferred recipe (example: Cooking teokbokki, Stir-Fried Rice Cake).

#### 1. Select teokbokki



#### 2. Check out the recipe and prepare ingredients for cooking



#### 3. Clean ingredients following each step



#### 4. Select Start Cooking button from the Introduction tab



#### 5. Touch the smart phone to your product.



#### 6. Start cooking



# HOW TO USE THE NFC FUNCTION



## Viewing dishes cooked by bloggers

It is possible to view blogger's dishes, and directly upload recipes of the dishes

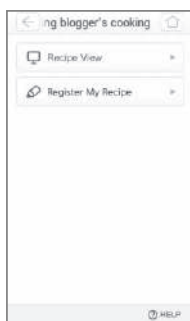

- 1 Viewing dishes**  
It allows view recipes uploaded by other bloggers or myself.
- 2 Uploading your own dishes**  
You can upload your own recipes of the dishes to share them with other bloggers



Please login to our website.  
If you don't have an ID, please sign up for your account before logging in to our website.

## Setting rice cooker

You can set various functions of the rice cooker using the NFC technology. The function settings are configured with Clock setting, Language & Voice Volume setting, Customized Rice Taste & Warming temperature setting and Power Saving setting.



- 1 Clock setting**  
You can easily set the time on the product.
- 2 Language & Voice Volume setting**  
You may select your language among Korean, English and Chinese, and adjust the volume for your convenience.
- 3 Customized Rice Taste & Warming temperature setting**  
You may select your preferred taste and warming temperature.
- 4 Power Saving setting**  
You can minimize power consumption in standby mode.



# HOW TO USE THE NFC FUNCTION

## Troubleshooting

The menu consists of Self-diagnosis, Checking trouble in advance, and Contacting our repair center

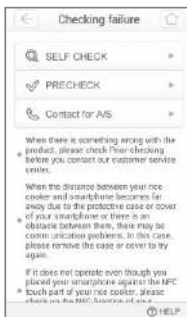
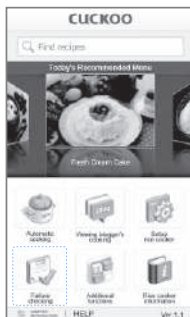

- 1 **Self-diagnosis**  
You can diagnose the current conditions of the rice cooker, and identify cause of abnormal conditions, if any, through the NFC function of your smart phone.
- 2 **Checking troubles in advance**  
If the product functions abnormally, you can identify the cause of trouble before you contact our repair center.
- 3 **Contact our repair center**  
You may find and contact the nearest local repair center.

## Other functions

Other functions include timer and diet management.

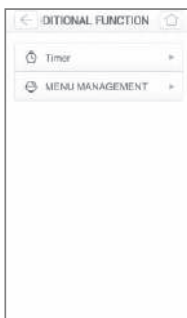
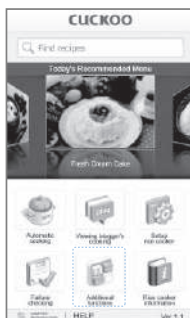

- 1 **Timer**  
You can use this function for conveniently measuring cooking time during cooking.
- 2 **Diet management**  
You can count how often you have been cooking and have calorie information for each dish for a day or a certain period of time through the NFC function of the smart phone.

## Product information

We will keep you updated on our new models and the list of replacements.



- 1 **Product information**  
Please keep yourself updated on our new models and the list of replacements so that your CUCKOO products can have a longer life span.



# CHECK BEFORE ASKING FOR SERVICE

▼ If there is a problem with your cooker, check the following details before requesting service to your dealer. Sometimes the cooker may not operate as desired if used incorrectly.

Case	Check points	Do the following
When cannot turn to "Unlock".	<ul style="list-style-type: none"> <li>• Did you turn the "Lock/Unlock" handle while cooking?</li> <li>• Did you turn the "Lock/Unlock" handle before exhausting steam perfectly?</li> </ul>	<ul style="list-style-type: none"> <li>• Don't open the lid while cooking. If you want to open lid while cooking, press the "Cancel" button more than 2 seconds and release the steam.</li> <li>• Pull the pressure handle to the side once and allow the steam to release.</li> </ul>
When the lid cannot open although the Lock/Unlock handle is turned to "Unlock".		<ul style="list-style-type: none"> <li>• Because of the pressure.</li> <li>• Pull the pressure handle to aside once and exhaust the steam perfectly.</li> </ul>
When the steam exhausted between the lid.	<ul style="list-style-type: none"> <li>• Is there an external substance on the packing?</li> <li>• Is packing too old?</li> </ul>	<ul style="list-style-type: none"> <li>• Clean the packing with duster.</li> <li>• Keep the packing clean.</li> <li>• If the steam is exhausted through the lid, please power off and contact the service center and dealer.</li> <li>• Packing life cycle is 12 month, please replace the packing per 1 year.</li> </ul>
When the "Cancel" button does not operate while cooking.	<ul style="list-style-type: none"> <li>• Is the inner pot hot?</li> <li>• Is currently the setting to lock mode?</li> </ul>	<ul style="list-style-type: none"> <li>• Keep pressing the "Cancel" button for 2 seconds for safety reason if you want to cancel while cooking.</li> <li>• Be careful of hot steam emission or hot contents spattered from the automatic steam outlet during cancellation.</li> <li>• Please press "Set" button for over 3 seconds to release.</li> </ul>
When you hear weird noises during cooking and warming	<ul style="list-style-type: none"> <li>• Is there a wind blowing sound when cooking the rice?</li> <li>• Is there a "Chi" sound when warming the rice?</li> </ul>	<ul style="list-style-type: none"> <li>• Is the inner pot inserted?</li> <li>• Check the rated voltage?</li> </ul>
Brown rice is not germinated properly	<ul style="list-style-type: none"> <li>• Does the amount of rice exceed the specified maximum capacity?</li> <li>• Is bean(other grains) too dry?</li> </ul>	<ul style="list-style-type: none"> <li>• Put the specified maximum capacity of brown rice.</li> <li>• Old rice or contaminated rice may not be germinated properly. (Refer to page 21)</li> </ul>

# CHECK BEFORE ASKING FOR SERVICE

▼ If there is a problem with your cooker, check the following details before requesting service to your dealer. Sometimes the cooker may not operate as desired if used incorrectly.

Case	Check points	Do the following
When the button cannot operate with “LJ”	<ul style="list-style-type: none"> <li>Is the inner pot inserted?</li> <li>Check the rated voltage?</li> </ul>	<ul style="list-style-type: none"> <li>Please insert inner pot.</li> <li>This product is 120V only.</li> </ul>
When the Pressure “Cook/Turbo” Timer button does not operate with “E01”	<ul style="list-style-type: none"> <li>Did you turn the Lock/Unlock Handle to “Lock”</li> <li>Is “pressure” lamp on?</li> </ul>	<ul style="list-style-type: none"> <li>Please turn the “Lock/Unlock” handle to “Lock”.</li> </ul>
When the rice is badly sticky.	<ul style="list-style-type: none"> <li>Is there any rice or any other alien substance on the temperature sensor or the bottom surface of the inner pot?</li> </ul>	<ul style="list-style-type: none"> <li>Clean all the alien substances on the temperature sensor or the bottom surface of the inner pot.</li> </ul>
When “E03” is showed on the LCD.	<ul style="list-style-type: none"> <li>Check the rated Voltage?</li> </ul>	<ul style="list-style-type: none"> <li>Cut the power and contact customer service.</li> <li>It is normal to get “E03” when putting only water.</li> <li>This is only for 120V.</li> </ul>
When the time cannot be preset.	<ul style="list-style-type: none"> <li>Is the current time correct?</li> <li>Is AM or PM set properly?</li> <li>Did you set the reservation time over 13 hours?</li> </ul>	<ul style="list-style-type: none"> <li>Set the current time(Refer to page 13).</li> <li>Check the AM and PM.</li> <li>Maximum reservation time is 13 hours. (Refer to page 26~27)</li> </ul>
When you smell after and before cooking?	<ul style="list-style-type: none"> <li>Is the inner pot correctly inserted in the main body?</li> <li>Is the Lock/Unlock handle on the top cover set to “Lock”?</li> <li>Is there hot food in the inner pot?</li> </ul>	<ul style="list-style-type: none"> <li>Please put in the inner pot perfectly.</li> <li>Please turn the “Lock/Unlock” handle to “Lock”</li> <li>Pull the pressure handle to aside once.</li> </ul>
When “E.u”, “00” are shown on the LCD by turns	<ul style="list-style-type: none"> <li>Micom power is out</li> </ul>	<ul style="list-style-type: none"> <li>Please cut the power and contact customer service</li> </ul>
When “E.e”, “00” are shown on the LCD by turns	<ul style="list-style-type: none"> <li>The sensor is broken</li> </ul>	<ul style="list-style-type: none"> <li>Please cut the power and contact customer service</li> </ul>
“E.u” mark shows up during the product operation	<ul style="list-style-type: none"> <li>Micom memory is out.</li> </ul>	<ul style="list-style-type: none"> <li>Please cut the power and contact customer service</li> </ul>
When “H.H”, “H.H” are shown on the LCD by turns		<ul style="list-style-type: none"> <li>Pressure Cook/Turbo “button is pressed?</li> <li>Is there power cut while in cooking?</li> </ul>

# CHECK BEFORE ASKING FOR SERVICE

▼ If there is a problem with your cooker, check the following details before requesting service to your dealer. Sometimes the cooker may not operate as desired if used incorrectly.

Case	Check points	Do the following
When the rice is not cooked.	<ul style="list-style-type: none"> <li>• “Pressure Cook/Turbo” button is pressed?</li> <li>• Is there power cut while in cooking?</li> </ul>	<ul style="list-style-type: none"> <li>• Press the “Pressure Cook/Turbo” button once. And check “E-3” sign on the display.</li> <li>• Re-press the “Pressure Cook/Turbo” button.</li> </ul>
When the rice is not well cooked.	<ul style="list-style-type: none"> <li>• Did you use the measuring cup for the rice?</li> <li>• Did you put proper amount of water?</li> <li>• Did you rinse the rice before cooking?</li> <li>• Did you put rice in water for a long time?</li> <li>• Is the rice old or dry?</li> </ul>	<ul style="list-style-type: none"> <li>• Refer to page 15-16</li> <li>• Add water about half the notch and then cook.</li> </ul>
Bean (other grains) is half cooked.	<ul style="list-style-type: none"> <li>• Is bean (other grains) too dry?</li> </ul>	<ul style="list-style-type: none"> <li>• Soak or steam beans and other grains before cooking in the pressure cooker in order to avoid partially cooked beans or grains. Beans should be soaked for -2-minutes or steamed for -2-minutes prior to cooking, depending on your taste.</li> </ul>
Rice is too watery or stiff.	<ul style="list-style-type: none"> <li>• Is the menu selected correctly?</li> <li>• Did you properly measure water?</li> <li>• Did you open the top cover before cooking was finished?</li> </ul>	<ul style="list-style-type: none"> <li>• Select the correct menu.</li> <li>• Properly measure water.</li> <li>• Open the top cover after cooking finished</li> </ul>
When the water overflows.	<ul style="list-style-type: none"> <li>• Did you use the measuring cup?</li> <li>• Did you use proper amount of water?</li> <li>• Is the menu selected correctly?</li> </ul>	<ul style="list-style-type: none"> <li>• Refer to page 15-16</li> </ul>
When you smell odors while warming.	<ul style="list-style-type: none"> <li>• Did you close the top cover?</li> <li>• Please check if the power cord is plugged.</li> <li>• Did it warm over 12 hours?</li> <li>• Is there any other substance such as rice scoop or cold rice?</li> <li>• Is bean (other grains) too dry?</li> </ul>	<ul style="list-style-type: none"> <li>• Select the correct menu.</li> <li>• Properly measure water.</li> <li>• Open the top cover after cooking finished</li> </ul>
“E-” “E-P” “E-L” Signs show up. “  ” Signs show up.	<ul style="list-style-type: none"> <li>• Temperature sensor or fan motor does not work properly.</li> </ul>	<ul style="list-style-type: none"> <li>• Unplug the power cord and call the Service center.</li> </ul>
Warming passed time mark blinks during keeping warm.	<ul style="list-style-type: none"> <li>• 24 hours has not passed yet after Keeping warm</li> </ul>	<ul style="list-style-type: none"> <li>• This function alarms if the rice remained warm for more than 24 hours.</li> </ul>
Rice has gotten cold or a lot of water flow during Keeping warm	<ul style="list-style-type: none"> <li>• Keeping warm was set in “Sleeping” mode</li> </ul>	<ul style="list-style-type: none"> <li>• Keep warm after cancelling or setting “Sleep Keeping Warm” mode depending on the necessity.</li> </ul>
If “E-co” sign is appears.	<ul style="list-style-type: none"> <li>• It shows on the display when pressing “Start” button again, or when the cooking has finished and you've never ever open turned the handle to “Unlock”</li> </ul>	<ul style="list-style-type: none"> <li>• It can be solved by turning handle to “Unlock” and then turn to “Lock”</li> </ul>
“E-co” sign shows up	<ul style="list-style-type: none"> <li>• Detachable cover is not mounted</li> </ul>	<ul style="list-style-type: none"> <li>• Mount detachable cover(Refer to page 10)</li> <li>• If “E-co” sign is displayed continuously even though you already installed detachable cover, please contact customer service.</li> </ul>
Alarm sounds or reheating does not work while keeping warm	<ul style="list-style-type: none"> <li>• Is bean (other grains) too dry?</li> </ul>	<ul style="list-style-type: none"> <li>• Mount detachable cover(Refer to page 10)</li> </ul>
When the NFC function is not operated	<ul style="list-style-type: none"> <li>• Does “SMART” appear on the control panel of your rice cooker?</li> <li>• Does your Smart Phone have the NFC (Near field communication) function?</li> </ul>	<ul style="list-style-type: none"> <li>• Please check your Smart Phone Manual to find out whether your phone has the NFC function or not.</li> <li>• This NFC function only supports android 2.3.3 and above</li> </ul>

MEMO



KOREAN

## CUCKOO ELECTRIC RICE COOKER/WARMER LIMITED WARRANTY

KEY Company, P&K USA TRADING CORP and Cuckoo Trading Canada, will repair at its option replace, without charge, your product which proves to be defective in material or workmanship under normal use, during the warranty period listed below from the date of original purchase. This warranty is good only to the original purchaser of the product during the warranty period. P&K USA TRADING CORP covers the east and the central districts, KEY Company covers the west and the central districts, Cuckoo Trading Canada covers the whole Canada.

### WARRANTY PERIOD

MODEL#	#LABOR	PARTS	HOW SERVICE IS HANDLED
CRP-AH10	1YEAR	1YEAR	<p>The East and the Central Districts Call : 718 888 9144 Address : 5-48 46th Road Long Island City, NY 11101, USA</p> <p>The West and the Central Districts. Call : 323 780 8808 Toll Free : 877 481 9828 Address : 1137 E. 1st Street, L.A, CA 90033, USA</p> <p>Canada (TORONTO) Call : 416 878 4561 / 905 707 8224 Address : #D8-7398 Yonge Street Thornhill Ontario Canada L4J 8J2</p> <p>Canada (VANCOUVER) Call : 604 540 1004 / 604 523 1004 Address : 945 Lougheed Hwy Coquitlam BC Canada V3K 3T4</p>

No other express warranty is applicable to this product. **THE DURATION OF ANY IMPLIED WARRANTIES, INCLUDING THE IMPLIED WARRANTY OF MERCHANTABILITY, IS LIMITED TO THE DURATION OF THE EXPRESS WARRANTY HEREIN. CUCKOO ELECTRONICS CO.,LTD, SHALL NOT BE LIABLE FOR THE LOSS, THE USE OF THE PRODUCT, INCONVENIENCE, LOSS OR ANY OTHER DAMAGES, DIRECT OR CONSEQUENTIAL, ARISING OUT OF THE USE OF, OR INABILITY TO USE, THIS PRODUCT OR FOR ANY BREACH OF ANY EXPRESS OR IMPLIED WARRANTY, INCLUDING THE IMPLIED WARRANTY OF MERCHANTABILITY APPLICABLE TO THIS PRODUCT.**

Some states do not allow the exclusion or limitation of incidental or consequential damages or limitations on how long an implied warranty lasts : so these limitations or exclusions may apply to you. This warranty gives you specific legal rights and you may also have other rights which vary from state to state.

### THE ABOVE WARRANTY DOES NOT APPLY IN THESE CASES :

- \* To damages problems which result from delivery or improper installation.
- \* To damages problems which result from misuse, abuse, accident, alteration, or incorrect electrical current or voltage.
- \* To serve call which do not involve defective workmanship or material and explaining the operation of the unit.

**Therefore, these costs are paid by the consumer. Customer assistance numbers :**

**To Prove warranty Coverage :** ► **Retain your Sales Receipt to prove date of purchase**  
 ► **Copy of your Sales Receipt must submitted at the time warranty service is provided.**

**To Obtain Product, Customer, or Service Assistance and Nearest Authorized service center , Parts Distributor or Sales Dealer:**

The East and the Central Districts  
Call : 718 888 9144  
Address : 5-48 46th Road Long Island City,  
NY 11101, USA

The West and the Central Districts.  
Call : 323 780 8808  
Toll Free : 877 481 9828  
Address : 1137 E. 1st Street, L.A,  
CA 90033, USA

Canada (Toronto)  
Call : 416 878 4561 / 905 707 8224  
Address : #D8-7398 Yonge Street  
Thornhill Ontario Canada  
L4J 8J2

Canada (Vancouver)  
Call : 604 415 9858/604 524 8282  
Address : 103-4501 North Road  
Burnaby BC Canada  
V3R 4R7

