

사용설명서

Operating Instruction

使用説明書

MANUEL D'UTILISATION

CR-0671

CUCKOO

always new

happiness

NO.1 CUCKOO

Mechanical type Electric Rice Cooker/Warmer

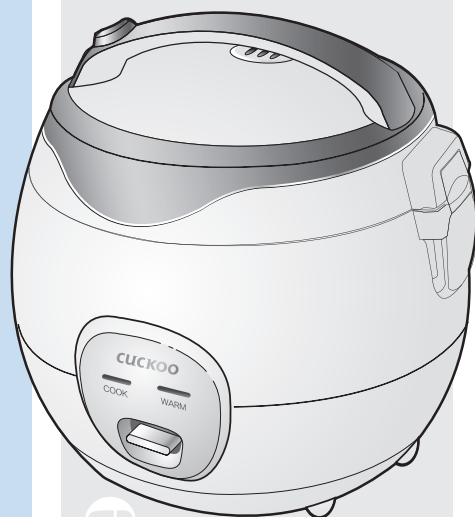

love

design

emotion

CUCKOO ELECTRONICS CO., LTD.

CONTENTS

저희 쿠쿠 전기 밥솥을 구입해 주셔서 대단히 감사 드립니다.

이 설명서를 잘 읽으시고 사용방법에 따라 정확하게 사용하십시오. 그리고 설명서는 보관해 두었다가 필요할 때 보시면 아주 유용합니다.

목 차

한글

Important safeguards	3
제품규격	5
안전상의 경고	6~9
각 부분의 이름	10
제품손질방법	11~12
사용방법	13~14
고장신고 전에 확인하십시오	15

Merci d'avoir choisi l'autocuiseur électrique CUCKOO.

Suivre les instructions avant toute utilisation et garder le manuel pour s'y référer dans le futur.

Sommaire

Français

Importantes consignes	3
Spécifications	5
Noms des composants	10
Consignes de sécurité	25~28
Nettoyage et entretien	29~30
Conseils d'utilisation	31~32
Avant de contacter le service	33

Thank you very much for purchasing "CUCKOO" Electric Rice Cooker/Warmer

Read all instructions before use.
Save these instructions for future reference.

Contents

English

Important safeguards	3
Specifications	5
Name of each part	10
Caution for safety	16~19
Cleaning and maintenance	20~21
How to use	22~23
Check before asking for service	24

感谢您选购 CUCKOO 福庫电子的电压力电饭煲

*请您在使用前仔细阅读此说明书，并按照正确方法使用；
阅读后请妥善保管，以备日后查阅。

*说明书中的图片可能与实物有所不同，以实物为准。

目录

Chinese

Important safeguards	3
产品规格	5
部件名称	10
安全警告	34~37
清洁保养方法	38~39
使用方法	40~41
常见故障及处理方法	42

IMPORTANT SAFEGUARDS

1. Read all instructions before using this appliance.
2. Do not touch hot surfaces. Use handles or knobs.
3. To protect against fire, electric shock and / or injury to persons do not immerse cord, plugs, or Pressure Cooker Body in water or any other liquid.
4. Close supervision is necessary when this appliance is used by or near children. This appliance is not intended for use by young children without supervision.
5. Unplug cord from outlet when not in use and before cleaning.
Allow appliance to cool before putting on or taking off parts, and before cleaning the appliance.
6. Do not operate any appliance with a damaged cord or plug, after the appliance malfunctions, or has been damaged in any manner. Return the appliance to the nearest authorized service facility for examination, repair or adjustment.
7. The use of accessory attachments not recommended by the appliance manufacturer may result in fire, electric shock, and / or injury to persons.
8. If the supply cord is damaged, it must be replaced by a special cord or assembly available from the manufacturer or your service agent.
9. Do not use outdoors.
10. Do not let the cord hang over the edge of a table or counter, or touch hot surfaces.
11. Do not place on or near a hot gas, electric burner, or in a heated oven.
12. Always attach the plug to the appliance first, then plug the cord into the wall outlet. To disconnect, or set all control to "off", then remove the plug from the wall outlet.
13. Do not use this appliance for other than its intended use.
14. Extreme caution must be used when moving an appliance containing hot oil or any hot liquids.
15. Oversized foods, metal foil packages, or utensils must not be inserted into the appliance as they are a risk of fire or electric shock.
16. Fire may occur if the appliance is covered or touching flammable material, including curtains, draperies, walls, etc while in operation.
17. To reduce the risk of electric shock, cook only in the provided removable container.
18. This appliance cooks under pressure. Improper use may result in scalding injury.
Before operating the unit, properly secure and close the unit. See "Operating Instructions."
19. Do not cook foods such as applesauce, cranberries, cereals, macaroni, spaghetti, or other foods.
These foods tend to foam, froth, and sputter, and may block the pressure releasing device
20. Before use always check the pressure releasing device for clogging.
21. Do not open the pressure cooker until the unit has cooled and internal pressure has been reduced.
See "Operating Instructions."
22. Do not use this pressure cooker to fry in oil.

SAVE THESE INSTRUCTIONS THIS APPLIANCE IS FOR HOUSEHOLD USE ONLY

ADDITIONAL IMPORTANT SAFEGUARDS

WARNING : This appliance generates heat and releases steam during use. Use proper precaution to prevent risk of burns, fires, other injuries, or damage to property.

1. Keep hands and face away from the Pressure Release Valve when releasing pressure.
2. Take extreme caution when opening the Lid after cooking. Severe burns can result from steam inside.
3. Never open the Lid while the unit is in operation.
4. Do not use without the inner Pot in place.
5. Do not cover the Pressure Valve with anything as an explosion may occur.
6. Do not touch the inner pot nor any heating parts, immediately after use.
Allow the unit to cool down completely first.

This appliance is intended to be used in household and similar applications such as :

- staff kitchen areas in shops, offices and other working environments;
- farm houses;
- by clients in hotels, motels and other residential type environments;
- bed and breakfast type environments.

MESURES DE PROTECTION IMPORTANTES

1. Lisez toutes les instructions avant d'utiliser cet appareil.
2. Ne touchez pas les surfaces chaudes. Utilisez les poignées ou les boutons.
3. Pour prévenir les risques d'incendie, les chocs électriques et/ou les blessures, ne plongez pas le cordon, les prises ou le corps autocuiseur dans l'eau ou tout autre liquide.
4. Une surveillance étroite est nécessaire quand cet appareil est utilisé par des enfants ou qu'il se situe à leur portée. Cet appareil n'est pas prévu pour être utilisé par de jeunes enfants sans surveillance.
5. Débranchez le cordon de la prise lorsque vous ne vous servez pas de l'appareil et avant de le nettoyer. Laissez l'appareil refroidir avant de remettre en place ou de retirer des pièces, et avant de le nettoyer.
6. N'utilisez aucun appareil si le cordon ou la fiche est endommagé, s'il ne fonctionne pas correctement ou s'il est endommagé de quelque façon que ce soit. Renvoyez l'appareil à un centre technique agréé le plus proche pour le faire examiner, réparer ou régler.
7. L'utilisation d'accessoires non recommandés par le fabricant peut causer un incendie, un choc électrique et/ou des blessures.
8. Si le cordon d'alimentation est endommagé, il doit être remplacé par un cordon ou ensemble prévu à cet effet, disponible auprès du fabricant ou de réparateurs agréés.
9. N'utilisez pas l'appareil à l'extérieur.
10. Ne laissez pas le cordon pendre d'une table ou d'un comptoir. Ne le laissez pas non plus en contact avec une surface chaude.
11. Ne placez pas l'appareil au-dessus ou près d'un brûleur à gaz, sur une plaque électrique ou dans un four chaud.
12. Branchez toujours la fiche sur l'appareil en premier, puis branchez le cordon dans la prise murale. Pour débrancher, ou désactiver toutes les commandes, retirez la fiche de la prise murale.
13. N'utilisez pas cet appareil à des fins autres que celles pour lesquelles il a été conçu.
14. Une prudence extrême est requise lorsque vous déplacez l'appareil contenant de l'huile chaude ou tout autre liquide chaud.
15. Des denrées alimentaires de taille excessive, les emballages sous feuille métallique, ou les ustensiles ne doivent pas être insérés dans l'appareil car ils constituent un risque d'incendie ou de choc électrique.
16. Un incendie peut se déclarer si l'appareil est couvert ou en contact avec des matériaux inflammables, y compris des rideaux ou des draperies, des murs, etc durant son fonctionnement.
17. Afin de réduire le risque de choc électrique, faites cuire uniquement dans le récipient amovible fourni.
18. Cet appareil cuit sous pression. Un mauvais usage peut entraîner des brûlures. Avant d'utiliser l'appareil, mettez l'appareil bien en place et fermez-le. Reportez-vous à la section « Instructions d'utilisation ».
19. Ne cuisinez pas des aliments tels que compotes de pommes, canneberges, céréales, macaronis, spaghettis ou autres. Ces aliments ont tendance à mousser, écumer et à crépiter et peuvent obstruer le dispositif de relâchement de la pression.
20. Avant toute utilisation, vérifiez toujours si le dispositif de relâchement de la pression est obstrué.
21. N'ouvrez pas l'autocuiseur jusqu'à ce que l'appareil ait refroidi et que la pression interne ait diminué. Reportez-vous à la section « Instructions d'utilisation ».
22. N'utilisez pas cet autocuiseur pour faire frire dans de l'huile.

CONSERVEZ CES INSTRUCTIONS

CET APPAREIL EST DESTINÉ À UN USAGE DOMESTIQUE UNIQUEMENT

MESURES DE PROTECTION SUPPLÉMENTAIRES

AVERTISSEMENT : Cet appareil génère de la chaleur et libère de la vapeur durant son fonctionnement. Utilisez les protections appropriées pour prévenir le risque de brûlures, d'incendies, de blessures ou de dégâts matériels.

1. Gardez vos mains et votre visage à l'écart de la soupape de décharge lors du relâchement de la pression.
2. Faites extrêmement attention lors de l'ouverture du couvercle après la cuisson. La vapeur à l'intérieur peut provoquer des brûlures graves.
3. N'ouvrez jamais le couvercle lorsque l'appareil est en fonctionnement.
4. N'utilisez pas l'appareil sans la cuve de cuisson à sa place.
5. Ne recouvrez pas la soupape de pression par un objet quelconque, une explosion pourrait survenir.
6. Ne touchez pas la cuve de cuisson ni les éléments chauffants immédiatement après utilisation. Laissez tout d'abord l'appareil refroidir complètement. Cet appareil est prévu pour être utilisé à la maison à des fins telles que :
 - la cuisine pour le personnel dans des magasins, des bureaux et d'autres environnements de travail;
 - les fermes;
 - par des clients dans des hôtels, des motels et autres environnements de type résidentiel;
 - des environnements de type chambres d'hôtes.

ADDITIONAL SAFEGUARDS

- ▶ Avoid touching hot parts : outer lid, inner pot, inner lid and especially the steam vent hole.
- ▶ Do not switch on when the main body is empty.
- ▶ Make sure that heating plate and the magnetic switch are clean and dry whenever putting the inner pot into the cooker.
- ▶ Do not use sharp instruments to clean the inner pot as these will damage the non-stick coating.
- ▶ A short power-supply cord is to be provided to reduce the risk resulting from becoming entangled in or tripping over a longer cord.
- ▶ Longer detachable power-supply cords or extension cords are available and may be used if care is exercised in their use.
- ▶ This appliance is intended to be used in household and similar applications such as :
 - staff kitchen areas in shops, offices and other working environments;
 - farm houses;
 - by clients in hotels, motels and other residential type environments;
 - bed and breakfast type environments.

SHORT CORD INSTRUCTIONS/SPECIFICATIONS

- Note : A. A short power-supply cord (or cord set) is to be provided to reduce the hazards resulting from becoming entangled in or tripping over a longer cord.
- B. Longer cord set or extension cords are available and may be used if care is exercised in their use.
- C. If a long cord set or extension cord is used.
- (1) the marked electrical rating of the cord set or extension cord should be at least as great as the electrical rating of the appliance.
 - (2) if the appliance is of the grounded type, the extension cord should be a grounding-type three-wire cord, and
 - (3) the longer cord should be arranged so that it will not drape over the counter top or tabletop where it can be pulled on by children or tripped over accidentally.

CAUTION : During use, the internal parts of the rice cooker and the area around the steam vent are **HOT**.
Keep out of reach of children to avoid possible injury.

제품규격/Specifications / SPÉCIFICATIONS / 产品规格

모델명 / Model Name / NOM DU MODÈLE / 型号	CR-0671	
전원 / Power Supply / CORDON D'ALIMENTATION / 额定电压	AC 120V , 60Hz	
소비전력 / Power Consumption / CONSOMMATION D'ÉNERGIE / 额定功率 (approx.) W	취사 / Cooking / 煮饭	500W
	보온 / Keeping Warm / 保温	60W
취사용량 / Cooking Capacity / CAPACITÉ DE CUISSON / 煮饭容量 L (Cups)	백미 / White Rice / 白米	0.36~1.0L(1.5~5.5 杯)
코드길이(m) / Power Cord Length(ft) / LONGUEUR DU CORDON D'ALIMENTATION / 电源线长度	1.4m/4.6ft/1.4 米	
외형크기 / Dimension / DIMENSION / 外形尺寸 cm (in)	길이 / Length / LARGEUR / 長	25.8cm
	폭 / Width / LONGUEUR / 宽	26.2cm
	높이 / Height / HAUTEUR / 高	27.8cm



CAUTION FOR SAFETY

- The following must be observed to use the product safely and correctly to prevent accidental and dangerous situations.
- 'Warning' and 'Caution' are different as follows.

Warning

This means that the action it describes may result in death or severe injury.

Caution

This means that the action it describes may result in injury or property damage.



- This sign is Intended to remind and alert that something may cause problems under the certain situation.
- Please read and follow the instruction to avoid any harmful situation.



- Indicates a prohibition.



- Indicates an instruction.

Warning

(Do not)

Do not use the cooker near hot things such as stove, gas stove or direct ray of light.



- It can cause an electric shock, fire, transformation or discoloration. Please check the power cord or plug frequently.

Please pay careful attention not to get any water or chemicals on the cooker.



- It can cause an electric shock or fire.

Keep the cooker out of children's reach.



- It can cause burns, electric shock or injury.

Do not sprinkle water on the cooker.



- It can cause an electric shock or fire.
- If it contacts water, please separate power cord and contact dealer or service center.

Do not over unplug and plug the power cord over and over.

- It can cause an electric shock or fire.

Do not bend, tie or pull the power cord by force.



- It can cause an electric shock or short circuit resulting in fire. Please check the power cord and plug frequently.

Keep your hand or face away from the steam outlet.



- It can cause burns.
- Especially keep it out of children's reach.

Do not open the lid while in heating and cooking.



- It can cause burns.

CAUTION FOR SAFETY



Warning



(Do not)

Use a single socket with the rated current above 15A.

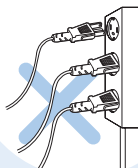

- Using several lines in one socket can cause overheating resulting in fire. Please check the power cord or plug frequently.
- Use an extension cord with a rated current above 15A.

Do not use damaged power cord, plug or loose socket.



- Please check the power cord frequently for damage.
- Serious damage can cause electric shock or fire.
- If the plug is damaged, contact the dealer or service center.

Do not use pots that are not designed for the cooker.

Do not use abnormal pot and do not use without the inner pot.

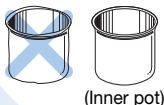

- It can cause an electric shock or fire.

Do not use on a rice chest or a shelf.



- Do not wedge the power cord between furniture. It can cause an electric shock resulting in fire. Please check the power cord or plug frequently.
- When using on furniture, automatically released steam can cause damage, fire, and an electric shock.

Do not use it without the inner pot.



- It can cause an electric shock or malfunction.
- Do not pour rice or water without the inner pot.
- If rice or water gets in then do not turn the product over or shake it, please contact the dealer or service center.

Don't spray or put any insecticide or chemicals on the cooker.



- It can cause an electric shock or fire.
- In case cockroach or any insects get inside of the cooker please call a dealer or a service center.

Do not alter, reassemble, disassemble or repair.



- It can cause fire, electric shock or injury.
- For repair, contact dealer or the service center.

Products such as metal rods inside. Do not insert alien substance.



- It can cause an electric shock or fire.

Do not place the product near dusty places or near chemical substances.

- Do not place the product near combustible gas or near inflammables.
- It can cause an explosion or fire.

Do not change, extend or connect the power cord without the advice of a technical expert

- It can cause an electric shock or fire.

Do not move the product by pulling or using the power cord.

- Electric short might cause fire.



CAUTION FOR SAFETY

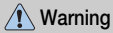

Warning

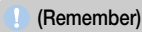

(Remember)

Do not plug or pull out the power cord with wet hands.

- It can cause an electric shock.

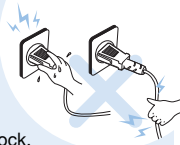

Be careful that both the plug and power cord are not to let animal bite or to be shocked by sharp metal materials.

- Damages by impact can cause an electric shock or fire. Please check the power cord or plug frequently.



Remove a foreign substance on the cord and plug with a clean cloth.

- It can cause fire. Please check the power cord and plug frequently.



Do not place heavy things on the power cord.

- It can cause an electric shock or fire. Please check the power cord and plug frequently.



Be careful not to harm your hand when opening the cover.

- Do not leave the cover opened. It might cause accident.



Clean any dust or alien substance off the temperature sensor, heating plate and inner pot.

- It can cause a system problem or fire.



Caution

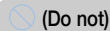

(Do not)

Do not touch the metallic surface of the inner pot and heating plate after cooking or warming.

- It can cause burns.



Do not use over the maximum capacity.

- It can cause overflow or breakdown.
- Do not cook over stated capacity for cooking of chicken soup and congee.



Do not cover the steam outlet with a duster, a towel or a pron, etc.

- It can cause a transformation or a breakdown.



Please pull the plug out when not in use.

- It can cause electric shock or fire.
- Use AC 120V only.

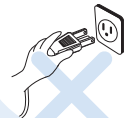

When warming, please close the cover and turn on the power.

- It may cause rice discolor or/and rice to stink.

If possible, only use warming function when cooking white rice. Other foods are easily discolored.

Take out the spatula before warming.

- It may cause rice discolor or/and rice to stink.

CAUTION FOR SAFETY



⚠ Caution

🚫 (Do not)

Don't use for various purpose for inner pot. and do not heat up the inner pot on the gas stove.

- It can cause the deformation of the inner pot.
- It can cause to spill the inner coating.



Use product on a flat surface. Do not use on a cushion. Please avoid using it on an unstable location prone to falling down.

- It can cause malfunction or a fire. Please check the power cord and plug frequently.



Please use the cooker for it's intended purpose.

- It can cause malfunction or smell.



Do not place on rough top or tilted top.

- It can cause burns or malfunction.
- Be careful to install the power cord which does not disturb to pass.



Do not drop or impact the cooker.

- It can cause a safety problem.



Do NOT use near wall or furniture. Otherwise wall or furniture may be damaged, discolored or deformed due to vapor or heat.

- When using in drawer cabinet etc, ensure that no vapor enters it.

Please call customer service if the inner pot coating peels off.

- Inner pot coating may wear away after long use.
- When cleaning the inner pot, do not use tough scrubber, metallic scrubber, brush, abrasive metallic etc.

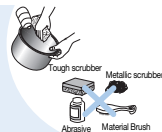

⚠ Caution

! (Remember)

Please contact dealer or service center if there is a smell or smoke coming from the cooker.

- First pull out the power cord. And contact dealer or the service center.



In case Cooking switch refuses to be pressed or does not work before or after use, contact your representative or service center.



Please pull out the plug when not in use.

- It can cause an electric shocks or fire.

Please clean the body and other parts after cooking.

- It can cause the transformation or smell.



Do NOT pull out or damage steam vent or steam vent seal packing.

- In case steam vent or steam vent seal packing is separated or damaged, stop using the device and contact your representative or service center.

To clean the product, wait until it cools down.

- Touch hot area may become a cause of burn.

Keep steam vent always clean with no foreign matters near it.

When you pull out the power plug, don't pull the power cord. Please, safely pull out the power plug.

- If you inflict impact on power cord, it can cause an electric shock or fire.



CLEANING AND MAINTENANCE

- Negligent cleaning may cause a bad smell while keeping the rice warm. Clean the lid frequently (Clean the rice cooker after pulling out the plug and wait until the main body cools.)
- Wipe the main body and the lid with a dry dishcloth. Do not use benzene or thinners.
- The rice water left on the inner lid or in the inner pot may form a starch film but it is harmless.

Inner Pot



Wipe alien materials and moisture from the outer and the bottom of the inner pot. Using a rough sponge, brush or abrasive may result in peeling of the coating. Use dishwashing detergent and a soft cloth or sponge.

Inner Lid

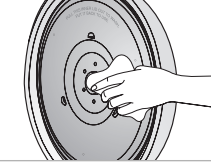

If rice water remains on the inner lid, wipe the lid with a dry dishcloth. Since the edge of the lid is made of metal, clean it with care.

Main Unit

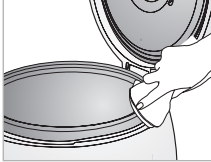

The rice water generated while cooking is designed to be collected in the dew dish. After cooking, clean it with a dry dishcloth.

Inner Body

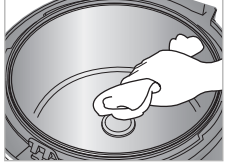

If alien materials stick to the temperature detector, remove them while avoiding damage to the metal plate. Wipe alien materials or moisture from the thermal plate.

※ Caution when cleaning inner pot

When cleaning the inner pot, do not clean it with sharp cutlery (fork, spoon etc) placed in the pot.

- It can cause damage on the inner pot coating.

How to detach/attach detachable cover

1 How to detach detachable cover

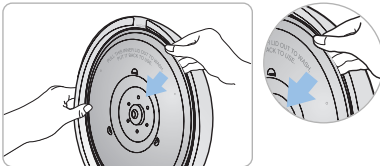

- ▶ Gently pull the detachable cover.
- ▶ Push the Detachable Cover lever upwards with the other hand, and gently pull the Detachable Cover. Then, it will be detached.

※ Do not grab and pull by the cover packing of the lid.

2 How to attach detachable cover

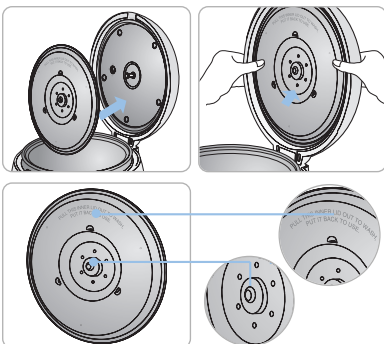

- ▶ Referring to the photo, push the detachable cover gently to the lid for attaching.

CLEANING AND MAINTENANCE



How to Manage the Inner Part

We have coated the inside of the product with non-stick fluorocarbon coating in order to prevent rice from sticking on the pot.

- Use the Rice Scoop.
- Do not put a metallic spoon or dishware into the product.
- Do not use benzene, thinner etc.
- If you have used seasoning, wash the product immediately after use.
- Some stain may remain during the use, but this does not affect the hygiene.

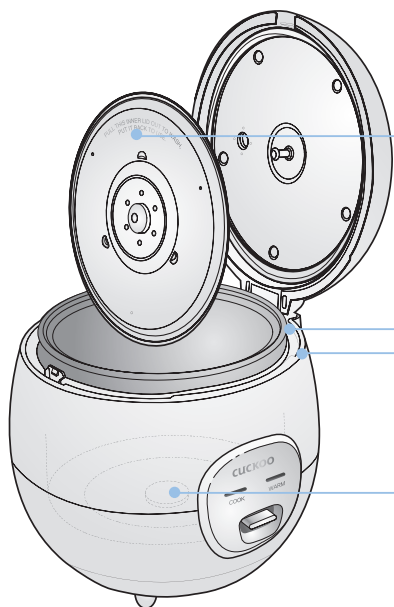

Before cleaning, pull out the detachable cover.

When storing, cooking, and warming, make sure to wipe out all the moisture off the outer part of the oven. It may cause outer coating to change color.

After cooking, wipe the excess water with a wet cloth to prevent any smell in the future.

If there is any alien substance on the temperature sensor carefully wipe it out without dampening the metal plate.

Wipe the body frequently with dry cloth, soft material or etc.

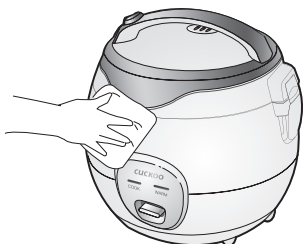

Wash inner lid and accessories with running water and wipe them with dry cloth.

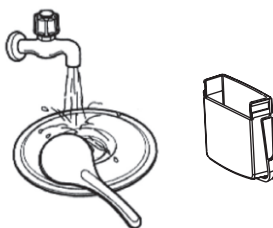



HOW TO USE

1 Measure rice precisely with measuring cup.

- ▶ One measuring cup of rice is about 180mL, the cooking amount for 1 serving of adults.



2 Wash rice in container other than Inner pot.

- ▶ How to wash rice

- ① Wash rice by rubbing it 20 times or so with palm in separate container.
- ② Rinse rice sufficiently until clear water comes out.
- ③ For better taste of rice, cook washed rice after leaving it for 30 minutes or so in sieve.



3 Put washed rice in Inner pot and adjust water amount.

- ▶ The graduations of Inner pot serve as the criteria to adjust water level. For instance, to cook rice for 3 servings, put 3 measuring cups of washed rice into Inner pot, and adjust water precisely so that water may be filled up to graduation of 3.

※ Water may be adjusted accurately only if Inner pot is placed at horizontal place.

▶ Water Amount:

- When rice is swollen sufficiently — Pour less water than specified amount.
- For thicker rice —
- When cooking with long-stored rice — Pour more water than specified amount.
- For soft-boiled rice —

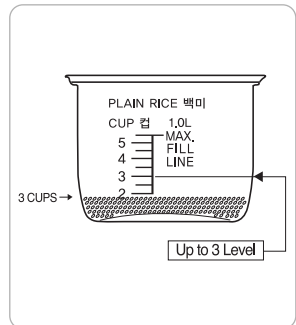

▶ CAUTION

- If rice and water amounts are not adjusted precisely, rice won't be cooked to desired condition.
- If rice amount exceeds maximum rice graduation, rice may not be cooked.



- 4** Put Inner pot and close the lid tightly.



- 5** Connect power plug, and press Cooking switch.

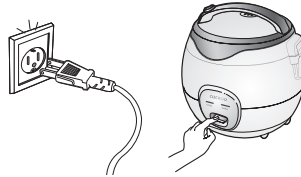

- 6** Once cooking is completed, the cooker enters Warm mode automatically.
(Please keep the lid closed for 15~20 Mins in Warm mode for better taste.)



- 7** Before having the rice, please stir the rice after 15~20 Mins in Warm mode. Then close the lid and keep the cooker in Warm mode.

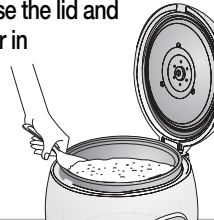

Take note

- To remove odor during Warming:
 - Pour water in Inner pot up to the graduation for 10 servings cooking.
 - Close the lid of Inner pot, and press Cooking button.
 - Leave the water boiling for 10 minutes or so, and switch to Warm mode.
 - When water is cooled down properly, take out inner pot and inner lid and wash them clean.
- After product is opened, foreign matters may be stained at Inner pot. Wash Inner pot clean before using it.
- If inner lid is not attached, warm performance may drop. Be sure to attach separable cover before use.
- NEVER use inner pot for purpose other than rice cooking. If inner pot is used for other purpose, remove odor in the method provided in paragraph 1 before cooking.
- What is melanoizing?
Rice cooked/warmed in this rice cooker will assumes slightly yellowish tone at the bottom. This is a phenomenon called melanoizing which is intended to produces the unique soothing flavor and taste of rice.
- During warming, 'click' sound may occur from the product. This sound indicates that thermometer is working properly and does not mean it's malfunctioned.
- This rice cooker is designed so that power be supplied and lamp illuminate even when Inner pot is not in place. (When the rice cooker is not used, pull out power plug.)

CHECK BEFORE ASKING FOR SERVICE

▼ If the cooker is not used according to specified procedure, it may not work properly even though the cooker is not malfunctioned.

If rice does not cook properly or warm is abnormal, check the condition per the checklist below. If abnormality still persists even after checking, consult customer care center.

Symptom	Checkpoint	Action
Rice water overflows	<ul style="list-style-type: none"> Wasn't there too much water beyond criteria water level when rice was cooked? Was the rice cooked without inner lid attached? 	<ul style="list-style-type: none"> Open the lid and take out water. Attach inner lid.
Cooked rice is: <ul style="list-style-type: none"> Too thick Half-cooked Too soft-boiled 	<ul style="list-style-type: none"> Is water adjusted to proper level? Is there any foreign object stuck at the outer bottom of inner pot, or is the bottom of inner pot uneven? Did you open the lid without waiting 15 mins after Cooking switch was turned off? Wasn't power cut or did Cooking switch go OFF during rice cooking? 	<ul style="list-style-type: none"> Adjust water level to measurement graduation depending on rice amount. Clean foreign object. Keep the lid closed and let the steam settled as long as possible. Do not touch Cooking switch until rice cooking is completed and the switch turns OFF automatically.
Rice is scorched and stuck to Inner pot.	<ul style="list-style-type: none"> Was the rice washed properly? Wasn't Cooking switch pressed forcefully even if rice cooking is completed and the cooker switched to warm mode. Wasn't the rice cooked without the scorched trace at the bottom of inner pot washed off? Wasn't there any foreign object stuck between heating plate and inner pot when rice was cooked? 	<ul style="list-style-type: none"> Wash rice clean always. Once rice cooking is completed, NEVER press Cooking switch. Use inner pot cleanly always. Use heating plate and inner pot cleanly always lest foreign object should stick to them.
Cooked rice has odor or is discolored in warm mode mode.	<ul style="list-style-type: none"> Is the lid closed tightly? Does power plug refuse to be pulled out during warming? Was there any spatula, cold rice or other grains during warming? Wasn't the amount of rice too small? 	<ul style="list-style-type: none"> Close the lid completely to allow no gap. Keep power socket plugged always during warming. Do NOT put in spatula, cold rice or other grains. If the amount of rice to remain in warming mode is small, gather rice at the center of inner pot during warming.

MEMO



CUCKOO ELECTRIC RICE COOKER/WARMER LIMITED WARRANTY

KEY Company, P&K USA TRADING CORP and Cuckoo Trading Canada will repair at its option replace, without charge, your product which proves to be defective in material or workmanship under normal use, during the warranty period listed below from the date of original purchase. This warranty is good only to the original purchaser of the product during the warranty period. P&K USA TRADING CORP. covers the east and the central districts, KEY Company covers the west and the central districts, Cuckoo Trading Canada covers the whole Canada.

MODEL# #LABOR PARTS
CR-0671 1YEAR 1YEAR

WARRANTY PERIOD HOW SERVICE IS HANDLED

The East and the Central Districts
Call : 718 888 9144
Address : 129-04 14th Avenue College Point, NY 11356, USA

The West and the Central Districts.
Call : 323 780 8808
Address : 1137 E. 1st Street, L.A, CA 90033, USA

Canada (TORONTO)
Call : 905 707 8224
Address : #D8-7398 Yonge Street Thornhill Ontario Canada L4J 8J2

Canada (VANCOUVER)
Call : 604 540 1004
Address : 945 Lougheed Hwy Coquitlam BC Canada V3K 3T4

No other express warranty is applicable to this product. **THE DURATION OF ANY IMPLIED WARRANTIES, INCLUDING THE IMPLIED WARRANTY OF MERCHANTABILITY, IS LIMITED TO THE DURATION OF THE EXPRESS WARRANTY HEREIN. CUCKOO ELECTRONICS CO.,LTD, SHALL NOT BE LIABLE FOR THE LOSS, THE USE OF THE PRODUCT, INCONVENIENCE, LOSS OR ANY OTHER DAMAGES, DIRECT OR CONSEQUENTIAL, ARISING OUT OF THE USE OF, OR INABILITY TO USE, THIS PRODUCT OR FOR ANY BREACH OF ANY EXPRESS OR IMPLIED WARRANTY, INCLUDING THE IMPLIED WARRANTY OF MERCHANTABILITY APPLICABLE TO THIS PRODUCT.**

Some states do not allow the exclusion or limitation of incidental or consequential damages or limitations on how long an implied warranty lasts : so these limitations or exclusions may apply to you. This warranty gives you specific legal rights and you may also have other rights which vary from state to state.

THE ABOVE WARRANTY DOES NOT APPLY IN THESE CASES:

- * To damages problems which result from delivery or improper installation.
- * To damages problems which result from misuse, abuse, accident, alteration, or incorrect electrical current or voltage.
- * To serve call which do not involve defective workmanship or material and explaining the operation of the unit.

Therefore, these costs are paid by the consumer. Customer assistance numbers :

To Prove warranty Coverage : ► **Retain your Sales Receipt to prove date of purchase**
► **Copy of your Sales Receipt must submitted at the time warranty service is provided.**

To Obtain Product, Customer, or Service Assistance and Nearest Authorized service center, Parts Distributor or Sales Dealer:

The East and the Central Districts
Call : 718 888 9144
Address :129-04 14th Avenue
College Point, NY 11356, USA

The West and the Central Districts.
Call : 323 780 8808
Address : 1137 E. 1st Street, L.A,
CA 90033, USA

Canada (Toronto)
Call : 905 707 8224
Address :#D8-7398 Yonge Street
Thornhill Ontario Canada
L4J 8J2

Canada (Vancouver)
Call : 604 540 1004
Address : 103-4501 North Road
Burnaby BC Canada
V3R 4R7