

KUDUwave™

thinking out the booth

User Manual

Contents

Introduction	2
Operator Training Requirements	3
Getting Started	5
Getting Started with the KUDUwave™ Software	12
Working with Folders	144
Working with Patients	20
Working with Clinical Tests	29
KUDUwave™ Tympanometer	47
KUDUwave™ Integrations	56
Settings	61
X-check (Cross Check)	64
Remote Assistance	69
Cleaning and Maintenance	69
Storage and Shipping	72
Expected Service Life	72
Disposal and Recycling	72
Traveling with Your KUDUwave™	72
Upgrades, Maintenance and Support	73
Troubleshooting	73
Technical Specifications	75
Electromagnetic Compatibility (EMC)	83
End User License Agreement (EULA)	87
Warranty and Disclaimer	88

Introduction

Purpose of this Manual

This manual provides instructions for use and describes the various functions and the features of the KUDUwave. It also describes how all the technologies involved in the KUDUwave's function work in conjunction.

This manual is not intended as a method to train KUDUwave operators to be healthcare professionals or to act as such. An operator may not act as a professional unless qualified to do so.

Medical Purpose

The medical purpose of the KUDUwave is to assist in testing the behavioral auditory responses of a patient and to determine hearing thresholds which will assist in diagnosis of hearing impairments.

Patient Populations

The KUDUwave is suitable for testing all patient populations, regardless of gender, age, weight, general health or ethnicity other than the following:

- very young children (suitable for ages 3+)
- patients with physical or mental disabilities that prevent them from signaling a response to a test audio tone presented to them.

During testing, patients should be calm and comfortable and free from distractions.

Device Description and Application

The KUDUwave is a mobile audiometer which provides compliant testing outside a certified sound room. The KUDUwave uses built-in sound attenuation and active noise monitoring to achieve this while including all the functions found in a typical audiometer.

The KUDUwave is suitable for open air testing in areas free from excessive noise. It must be kept dry and free from dust for reliable, safe operation. The KUDUwave is a highly sensitive and technically complex device that should be treated with care. We highly recommend that you use the robust, shock-absorbing, carry case to transport your device. Mark the package as FRAGILE when it is in transit.

Frequent Usage

The KUDUwave is suitable for continuous, regular use. Analysis of all its functions confirms that there is no risk to either the operator or patient. These functions are detailed within this document and include measures to minimise any potential risk.

Applied Parts Details



The following parts are defined as “applied parts” in accordance with BS EN 60601-1:

Ear Inserts: The Left and Right Ear Inserts will be positioned in the outer ear by the operator. They do not carry any electrical, chemical or mechanical energy and contain no metallic parts, and facilitate the delivery of sound energy to the patient’s ears.



Bone Vibrator: The bone vibrator is positioned against the patient’s forehead by the operator. From this position it can be used to deliver sound energy to the patient’s cochlea. The KUDUwave uses a certified bone vibrator from Radioear.

Operator Training Requirements

Basic Requirements

The operator must be a trained healthcare professional (typically an audiologist, hearing aid acoustician, general practitioner, ENT, nurse or audiometrist) or a practitioner who has been trained in audiometry. The operator must be able to read and communicate fluently in English and/or the primary language of the patient.











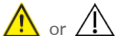

Training and Certification Requirements

Training is provided free of charge via an online session within the first 30 days of purchase for both facilitators and operators of the KUDUwave. Additional training resources are available via the [KUDUwave academy](https://sites.google.com/emoyo.net/kuduwave-academy/home) (<https://sites.google.com/emoyo.net/kuduwave-academy/home>) as well as a comprehensive helpdesk available at [KUDUwave.com](https://www.kuduwave.com). The operator will receive a certificate of completion after successfully completing their training.

Additional technical support is also available via our ticket based system, online chat, email and telephone with the KUDUwave support team. Additional group or one-one training may be provided at a cost, to be determined at such time as it is necessary.

Description of Symbols

The following important symbols are used on the KUDUwave and its components.:

Symbol	Description
	Manufacturer, eMoyoDotNet (Pty) Ltd, 179 Beyers Naude Drive, Johannesburg, South Africa
	EC Authorised Representative, PSF Medical BV, Marten Messweg 8, 3068AV Rotterdam, The Netherlands
	Symbol for CE Mark with Notified Body Number. Conforms to Medical Device Directive 93/42/EEC.
	Symbol designating Type B Applied Parts according BS EN 60601-1.
	Caution. Indicates the need for the user to consult the instructions for use for important cautionary information such as warnings and precautions that cannot, for a variety of reasons, be presented on the medical device itself.
	Consult instructions for use. Indicates the need for the user to consult the instructions for use.
	Single use only.
	Serial number.
	Batch code. Indicates the manufacturer's batch code so that the batch or lot can be identified.
IP20	Ingress protection.
	Keep Dry. Indicates that the medical device needs to be protected from moisture
	Temperature limit. Indicates the temperature limits to which the medical device can be exposed safely.
	Humidity limit. Indicates the range of humidity to which the medical device can be safely exposed.
	Fragile, handle with care. Indicates a medical device that can be broken or damaged if not handled carefully.

Getting Started

Get to know your KUDUwave™

All KUDUwave devices have the following capabilities:

- Pure Tone Air Conduction Testing
- Active Noise Monitoring
- Automated and Manual Testing
- Testing Protocols
- Patient Management and Medical Record Suite
- Telemedicine Enabled

Your KUDUwave can be one of the following configurations, which determines what tests it can perform and extra features it may have.

KUDUwave™ Prime	KUDUwave™ Plus	KUDUwave™ Pro
Screening	Screening	Screening
-	Diagnostic (Bone Vibrator Included)	Diagnostic (Bone Vibrator Included)
-	-	Monitoring of Ototoxicity
-	-	Extended High Frequency (up to 16kHz)

Tympanometry functionality can be added to all three configurations mentioned in the above table.

KUDUwave™ Prime TMP	KUDUwave™ Plus TMP	KUDUwave™ Pro TMP
Screening	Screening	Screening
Tympanometry	Diagnostic (Bone Vibrator Included)	Diagnostic (Bone Vibrator Included)
-	Tympanometry	Monitoring of Ototoxicity
-	-	Extended High Frequency (up to 16kHz)
		Tympanometry

KUDUwave™ Serial Number

The unique serial number is clearly marked on the bottom of the KUDUwave headset. Serial number information is required when contacting customer support and booking calibrations.

Unpacking the KUDUwave™ Hardware

The KUDUwave is packaged in a robust, shock-absorbing case designed to protect it during transportation. Inspect the case for signs of any damage and notify your supplier immediately if any signs of mechanical or physical damage are found.



Packaging Checklist

Please check that all items listed below are received in good condition. If any items are missing or damaged, immediately notify your KUDUwave™ distributor.

- The KUDUwave headset
- Three meter long twisted KUDUwave dual USB cable
- USB patient response button
- Radio Ear Bone vibrator with metal headband attached to the KUDUwave black headband with a screw (Plus and Pro configurations only)
- Calibration certificate
- Two sound tubes with bronze ear tip couplers, attached to the KUDUwave. (TMP configurations come with an additional two tympanometer probes)
- Spares (6 sound tubes and 1 brass connector) (TMP configurations come with two spare tympanometer probes)
- TMP configurations come with one calibration pod

Laptop Requirements

Laptop Minimum Requirements

- Core i3 Processor
- Windows operating system (no older than Windows 7)
- 4GB RAM
- No less than a 250GB hard drive
- WiFi enabled
- A Webcam
- 2 USB ports (response button can be plugged into one ear cup if necessary)

If a USB hub is required, please ensure it adheres to the below specifications:

- Self-powered (it must have its own power supply from an electrical wall plug)
- Supplies 5 Volts and 1 Amp per port
- USB 2.0
- at least 3 ports available for the KUDUwave connections (Left cup, Right cup and Response Button)

Software Installation

If your KUDUwave controller PC was professionally configured by eMoyo, all the necessary software will already be installed. Should this not be the case, or should you wish to install the software on more than one computer, please visit the KUDUwave website (www.kuduwave.com). Click on the software link on the top bar, and select KUDUwave 5 Software.

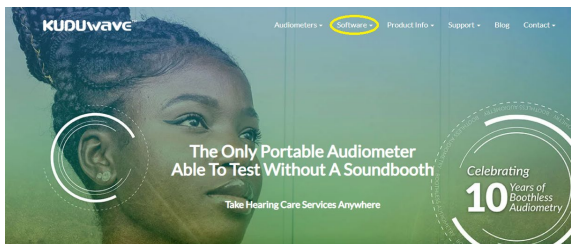

KUDUwave 5.2.0.2 Software
Fill in the form below to download the latest KUDUwave Software.

First name*	Last name*
<input type="text"/>	<input type="text"/>
KUDUwave Serial No.	Email Address*
<input type="text"/>	<input type="text"/>

We use the contact information you provide to us in order to update you on our software, products and services. You may unsubscribe from these communications at anytime.

[Go To Downloads](#)

Submit yours or a representative's contact information here, to gain access to the downloads page. These details will be added to our customer database so that you may be alerted of any changes or updates to the software. The [change log](#) is also publically available on our website and is regularly reviewed for any updates.

Next, download the software from the provided link and run the saved installation file as an administrator. Use the chat function in the bottom right hand corner of your screen to chat to us live if you need help.

Software Launch



You should find this KUDUwave 5 shortcut on your PCs desktop. Alternatively you can find KUDUwave 5 under programs in your start menu. Launch immediately after installation or, click the icon to launch.

Software Language

The software is currently available in English, Spanish, French, Portuguese, Bahasa and Dutch.

Preparing the Test Environment

It is essential that the test environment is as quiet as possible in order to ensure test compliance and that the patient is not disturbed. The KUDUwave software will indicate if ambient noise is too loud and is disrupting the test. The test environment should be free from any distractions that may disturb either the operator or the patient as these may result in incorrect test results.

Preparing and Positioning the Patient

The patient should be seated in the test environment near to the test computer but should not be able to view the computer screen. Care should be taken to ensure the patient is comfortable so as to minimise distractions.

If the patient is unable to sit, care must be taken to ensure they are positioned in as comfortable and relaxed a position as is possible. Patients who are notably anxious should be calmed and reassured before testing.

Preparing the KUDUwave™ Equipment

Connecting the KUDUwave™

Plug the larger USB plugs into the USB ports of the PC. Plug the smaller plugs into the corresponding ports of the KUDUwave headset.



The KUDUwave will indicate the right side with a red light (**Note this is not a warning light**) and the left side with a blue light when powered. You will now be able to begin testing. If the device is not plugged in, it will not be possible to proceed to testing until the device is properly connected.

Ensure that the cables are positioned out of the way so that they are not a hazard.

Device Drivers

KUDUwave is a plug and play device and all drivers will automatically begin installing when KUDUwave's USB cables are plugged into a PC. If the device is plugged into a different USB port on the same computer for the first time, then some drivers will be installed again. Please wait until Windows notifies you that the drivers have been installed successfully.

Warning: If you launch the KUDUwave software before the drivers were installed, the KUDUwave software will prompt you that it could not find the device, even though the device is plugged in. Contact Support should the drivers still not find the device.

Performance Verification of the KUDUwave™

To test the KUDUwave hardware, plug in the device and perform X-Check (built in calibration verification tool). This will also indicate any performance issues. Report any faults found to your distributor.

Disconnecting the KUDUwave™

If it is required that the KUDUwave be disconnected, ensure all test data is saved and close the KUDUwave 5 software. The USB cables can then be unplugged. For safe storage and to extend the lifespan, please wind the USB cables in large loops when returning to the case for storage.

Ear Inserts

Ear tips must be firmly attached to the plastic tubes using the brass couplers. Ear tips are intended for single use and should be disposed of as medical waste after testing. eMoyo will not be held liable for any complications if eartips are reused.



USB Patient Response Button

Connect the USB cable of the response button to either one of the ear cup USB ports, or into a third USB port in the PC. A light will pulse (come on and switch off again) if connected correctly.



Positioning the KUDUwave™ Headset

When not in use, place the headset on a stable surface. Cleaning and disinfection can be done with cleaning wipes which are intended for cleaning plastics, that comply with EN1276.

Although there are a number of ways to position the KUDUwave correctly on the patient's head, the following technique is recommended:

Step 1: Initial Position



Gently place the KUDUwave headset on the patient's head, resting just above both ears. Ensure the headset is positioned correctly i.e. the left ear cup must be on the patient's left hand side and vice versa.

Step 2: Insert Eartips



Squeeze and roll the foam tip down to its smallest diameter using your thumb and index finger. Pull the ear by the pinna (up and back for adults, and down for children) and insert the foam tip into the ear canal. Ensure that the ear tip is fully inserted. Hold the ear tip in position while the memory foam expands to fill the ear canal. This will ensure that the eartip sits firmly in place. A loosely fitted ear tip or shallow insertion will result in testing inaccuracy.

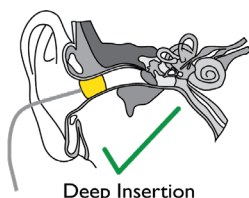

Deep Insertion

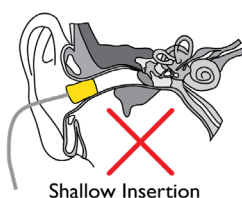

Shallow Insertion

Yellow eartip inserts are intended for most ear canal sizes while beige eartip inserts are intended for very small ear canals (i.e. children).

Warning: Improper selection or insertion of eartips may affect test results.

Step 3: Final Position



The headset can now be lifted and placed over the patient's ears. Ensure the ear cups are supported by the headband and do not hang on the ears. Care must be taken not to dislodge the ear inserts from the patient's ear canal.

It is important to lift the left and right ear cups slightly in turn to visually confirm the ear inserts are still correctly positioned. Make sure that the tubing is not tangled under the cups. The tubing should loop out under the cups towards the front of the ear to avoid tangling and or bending.



Step 4: Bone Vibrator Positioning

If the bone vibrator is to be used, the metal headband must be adjusted and placed over the patient's head. Ensure that it is positioned carefully on the patient's forehead, in line with the middle partition between the eyebrows or in line with the centre between their eyes.

Warning: Bone vibrators are calibrated to a specific KUDUwave intended for forehead placement. They are not interchangeable between KUDUwaves. Swapping of bone vibrators between devices may result in inaccurate testing. If you are unsure about which bone vibrator should be used with your KUDUwave please check its calibration certificate or alternatively contact eMoyo support.

Step 5: Patient Response Button

The Patient Response Button must be placed in the patient's hands. Ensure that the cable does not become tangled or damaged. The patient must keep their finger on the button and be ready to press it when a sound is played. The patient must be told to press the button as quickly as possible and then let go of the button.

Remote Testing

The KUDUwave can easily and safely be used for remote testing over local and internet connections.

To test remotely:

1. The trained operator starts the KUDUwave 5 software application on his or her local personal computer.
2. A connection is made to a KUDUwave headset connected to a remote personal computer.
3. The remote personal computer is specified using its unique IP address.
4. A trained facilitator can then fit the KUDUwave headset on the patient.
5. The operator can proceed with the test.

Both the operator and facilitator need to complete the eMoyo KUDUwave training.

Getting Started with the KUDUwave™ Software

Practitioner Details



Run the KUDUwave 5.0 application by double clicking on the  icon on your desktop or start bar, and enter your details to continue. These details will appear on all reports and audiograms. You can also select your language of choice. Press enter or click the “Go” button to move forward.

KUDUwave™

Details to appear on reports

Full name

Name of professional association

Registration number

Go English

Home Page

Your Portal to Patient Management

The home page appears as below with 3 main sections.

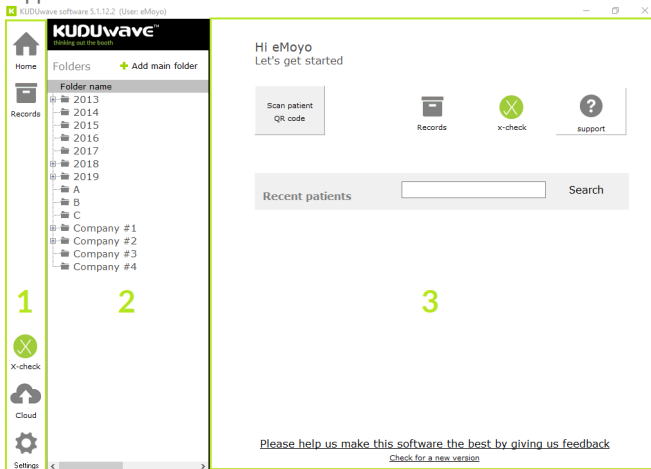

1. System Menu

Here you have access to:

- Home *(return to the home page)*
- Records *(return back to the folder you were busy with)*
- X-check *(built in automated calibration verification tool)*
- Cloud *(synchronization of data to eMoyo cloud storage)*
- Settings *(backup data, personalise your reports and more)*

2. Folder Management Pane

Folders can be created and managed here. Organise your patient files and make record retrieval quick and easy.

It is recommended to organise patients either under alphabetical folders, organisation / company names or according to the date (month/year) they were tested.

See more examples on the KUDUwave help desk at:
helpdesk.kuduwave.com/software/folder-management

3. Data View Pane

A series of quick links are made available for your convenience.

- Scan QR codes *(for quick retrieval of patient data)*
- Records *(returns back to the folder you were busy with)*
- X-Check *(built in automated calibration verification tool)*
- Support *(navigates to our website to contact the support technicians)*
- Search *(filter through your recent patients listed below the search tool)*

Give us your feedback

Help us improve the KUDUwave by giving us your feedback.

In the software is a link to a short 5 min survey, where you can let us know how you are experiencing your mobile audiometer and its accompanying software. We'd appreciate your feedback so we can improve your KUDUwave experience.

Please help us make this software the best by giving us feedback

[Check for a new version](#)



Or contact us through our website : www.kuduwave.com.

Working with Folders

Management of folders is done within the Folder Management Pane

Creating Folders and Subfolders

To create a folder click: **+ Add main folder**

Enter the name of your folder in the space provided. Select a smart folder setting if you wish to use this feature. Learn more in the [Smart folder section](#). Select “OK” to save.

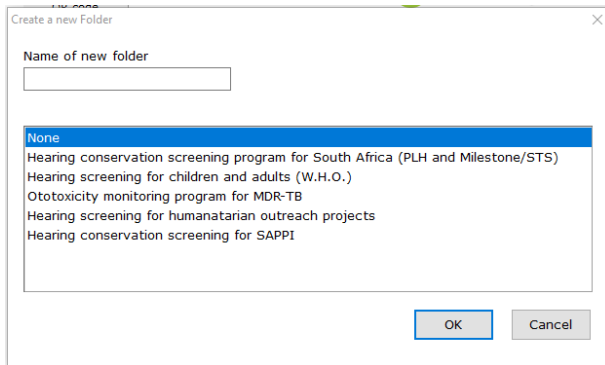

Patient details will only be displayed, if the folder they fall under is selected. Once a folder is selected, a subfolder can be created by clicking the **+** icon next to its name.

Access a folder by clicking on the folder name. Double click on the folder name or click on the **📁** icon to view subfolders. To hide subfolders, double click again on the folder icon or click on the **📁** icon.

Selecting a folder or subfolder will display its contents in the right hand pane.

KUDUwave™
thinking out the box

Files (x86)
eMROYO | Data | Patients | Current | 2019

Smart folders
Default folder type

Folders **+ Add main folder**

Patients **+ Add patient** **+ Add QR patient** **Import Smart Mosa** Find

Folder name	Name	Surname	Date of Birth	Sex	ID/SS	Passport	QR code
2015	Mary	Jones	1970/09/01	Female	700901003708		F53DDB79EB85424699
2016	John	Smith	1955/01/01	Male	550101003708		B6120C89A50B4FDCB3
2017							
2018							
2019							
01 Jan							
02 Feb							

Smart Folders

The KUDUwave uses multiple criteria (OSHA, SANS, WHO etc.) to develop testing protocols and assistive interpretations of results. The KUDUwave also uses these criteria to separate which test

protocols are most needed and used by a particular industry.

To streamline the process of choosing which tests need to be done with which patients, you can change the default settings of the folder. Change the smart folder type by selecting the folder and click on “Smart folders” in the top right hand corner.



Under the “Smart folder type” there are six available smart folder configurations, each with their own user interfaces and pre-selected tests for all patients in this folder. Select one option.

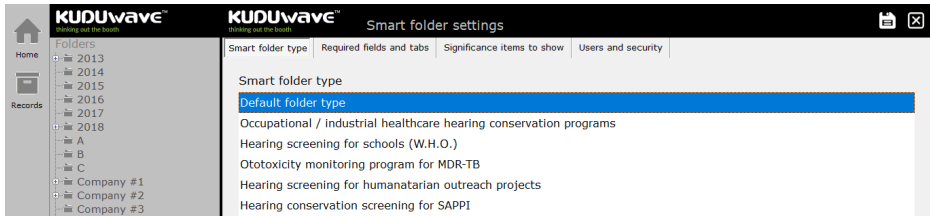

Under “Required fields and tabs”, you can customise the selected smart folder type by selecting which details you want to make required fields. These fields will be required to be filled in before any tests can be conducted.

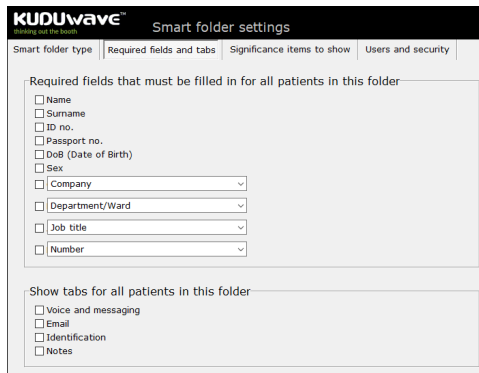

If you are not in the occupational health sector you can change the last four field names to relate to a hospital or school setting.

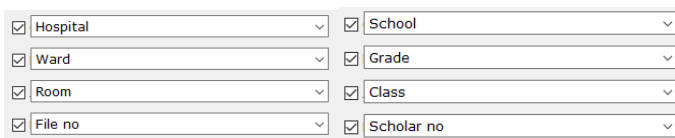

Under “Significance items to show”, you can select the labels which are available to use for the tests generated in this folder.

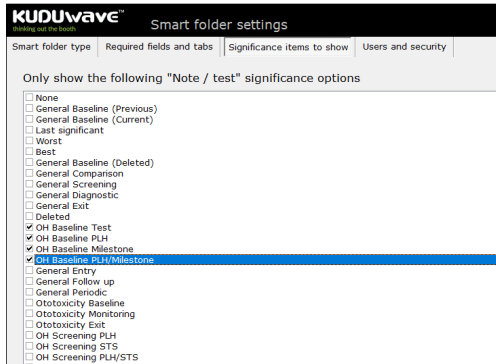

Under “Users and security”, you can contact eMoyo by completing the online form, to setup folder security providing restricted access to particular folders.

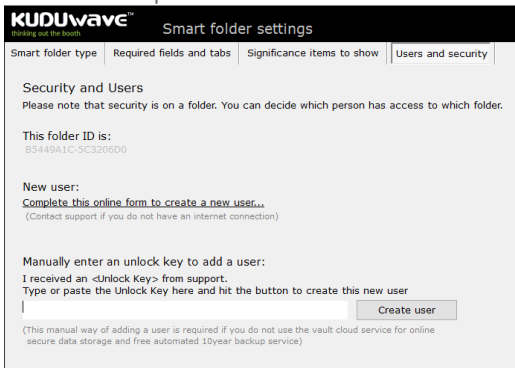

Click the save icon  to save changes. The folder type will be displayed at the top right hand corner of your screen.

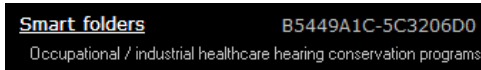

How to use the MDR-TB Screening Smart Folder

This folder specifically caters for the MDR-TB set-up in South Africa, but can be applied to other projects across the world.

Which tests can I perform in this folder type?

- Extended high frequencies with the KUDUwave Pro™.
- Incorporates questionnaires for the patient, including records of which medication the patient is currently receiving.

- Automatically continues with the test after the questionnaire is completed.
- Assistive Interpretation done after testing and any indication of ototoxicity is highlighted in a report.

How do I start testing?

1. After adding a patient to the smart folder, click on +Note/Test to open a new test.
2. This next menu will appear for you to select the relevant test you want to perform. (Baseline/Initial, Monitoring or Exit, depending on the patient and where they are in the program stages) You can return to the normal interface by clicking on the button "Select a new Test / Note / Interpretation / Notification" in the top left corner. Once you click on a button, the automatic testing sequence will begin:
 - Questionnaire / Form
 - Test
 - Assistive Interpretation
3. At any point during the test you can manually take over by clicking on pause.
4. Save after each step.

Select a new Test / Note / Interpretation / Notification X

First visit (Preferably before potentially ototoxic medication is administered)

Not yet on medication: Complete baseline form Do baseline test Interpret Baseline
Enter baseline test

Already on medication: Complete initial form Do initial test Interpret Initial
Enter initial test

Follow-up visits (Regular comparison tests as per protocol)

Screening today: Complete monitoring form Do monitoring test Interpret Monitoring

Exit visits (As per protocol after the ototoxic medication was stopped)

Exit: Complete exit form Do exit test Interpret Exit

- As a patient enters the MDR-TB monitoring program (i.e. it is their first visit to the clinic), an initial / baseline form, test and assistive interpretation must be recorded.
- If the patient has already completed their baseline test (for example he was first tested a year ago), manually enter these results into the KUDUwave database by clicking: Enter baseline / initial test.

NOTE: You cannot perform a Monitoring or Exit test until the patient's full history is manually entered into the system.

- Once the manually recorded results are saved in the database, you can continue on to the monitoring test.
- When the patient arrives for their next follow-up visit, complete the monitoring form, test and interpretation.

- Once the patient is ready to exit the program, complete the exit form, test and interpretation.

How to use the Occupational (Industrial) Healthcare smart folder

Using this smart folder type simplifies the method of testing to identify early hearing loss and to calculate measures for compensation.

Which tests can I perform in this folder type?

- Milestone Baseline & STS Screening (Standard Threshold Shift)
- PLH Baseline, Screening and Exit (Percentage Loss of Hearing)
- A combination of both Milestone & PLH Baselines or STS & PLH Monitoring

How do I start testing?

1. After adding a patient to the smart folder, click on +Note/Test to open a new test.
2. This next menu will appear for you to select the relevant test you want to perform. The test will begin automatically when you click on a button. You can return to the normal interface by clicking on the button "Select a new Test / Note / Interpretation / Notification" in the top left corner.
3. At any point during the test you can manually take over by clicking on pause.
4. Save the test once it is completed.

If you want to collect a baseline result, select the type of test from the top section:

- Complete two baseline tests, or even a third if you suspect the patient is malingering.
- Click "Interpret" to use the assistive interpretation tool.
- Manually enter the baseline results of the patient if they were tested before, but are new in the KUDUwave database.

If you want to collect a follow up result, select the type of test from the bottom section:

Collect entry/screening/follow-up/periodic/exit PLH (ZA) and STS monitoring tests

PLH (ZA) screening:	<input type="button" value="Do"/>	<input type="button" value="Interpret"/>
STS monitoring:	<input type="button" value="Do"/>	<input type="button" value="Interpret"/>
Combined PLH (ZA) screening and STS monitoring test:	<input type="button" value="Do"/>	<input type="button" value="Interpret"/>

- If the patient already has a baseline result in the database, continue to complete the follow up test (screening /monitoring).
- Click "Interpret" to use the assistive interpretation tool.

How to use the School Screening Smart Folder

This folder is a solution for mass screening of children, to quickly identify those who need help early on. The automatic test is designed to be efficient, sweeping four frequencies between 25 dB HL and 90 dB HL.

Which tests can I perform in this folder type?

- Pure tone test which finds thresholds from 25 - 90 dB HL at 500Hz, 1kHz, 2kHz and 4kHz.

How do I start testing?

1. After adding a patient to the smart folder, click on +Note/Test to open a new test.
2. This next menu will appear for you to start the automatic test. You can return to the normal interface by clicking on the button "Select a new Test / Note / Interpretation / Notification" in the top left corner.
3. At any point during the test you can manually take over by clicking on pause.
4. Save the test once it is completed.



How to use the Humanitarian Screening Smart Folder

This folder is designed to screen masses efficiently and effectively. The quick automatic test sweeps through 5 frequencies between 25dB HL and 90dB HL.

Which tests can I perform in this folder type?

- Pure tone test which finds thresholds from 25 - 90 dB HL at 500Hz, 1kHz, 2kHz, 4kHz and 8kHz.

How do I start testing?

1. After adding a patient to the smart folder, click on +Note/Test to open a new test.
2. A similar menu as the school screening smart folder above will appear for you to start the automatic test. You can return to the normal interface by clicking on the button "Select a new Test / Note / Interpretation / Notification" in the top left corner.
3. At any point during the test you can manually take over by clicking on pause.
4. Save the test once it is completed.

Working with Patients

Add and manage your patient data within the Patient Interface. The patient interface will appear when a new patient is created or by double clicking on the patient file in the data view pane of home page.

Adding a New Patient

To create a new patient, first select or create the folder under which the patient should be stored, then click **+ add patient**. This will open the Patient Interface where you can add the patient's details in the Patient Data Pane (4). Any test data can be previewed in the Test Data Pane (5). To edit patient details, select the field by clicking in the field and enter the new information. All tests thereafter will have the updated information.

The screenshot displays the 'Patient Example (38yr Male)' interface. On the left is a sidebar with 'Home', 'Records', 'X-check', and 'Settings' icons. The main area is divided into two panes. The left pane, labeled 'Patient details', contains a form with fields for Name (Patient), Surname (Example), ID no. (123456789), Date of Birth (1980/01/01), Sex (Male), Company (Default), Department (Department), Job title (Job), and Number (1). Below the form is a 'History' section with a '+ Note / Test' button and a table with columns 'Date and time', 'Significance', and 'Type'. The right pane, labeled 'Test Data Pane', contains the text 'No clinical notes. Click on * Note / Test *'. A legend at the bottom of the screenshot identifies the sidebar as '1', the patient details form as '4', and the test data pane as '5'.

Tips:

- Click the tab key to quickly navigate between fields.
- After entering a South African ID number, date of birth, age and gender will automatically be populated.
- Folder names are assumed to be company names, and subfolders as job titles. These fields will be automatically populated with these details. Correct them if need be and the option will become available in the drop down menu for each patient which is added later. To delete an item from a drop down menu, select it, and then click the "X" icon.

- To refresh click 

Company	Default	⊗	Department/Ward	Testing	⊗
	Hospital / Clinic / School			Ward / OPD / Grade	
Job title	Job	⊗	Number*	1	
	Job title / Bed / OPD room / Class			Employee no / File no / Scholar no	

Additional Details

There are four additional tabs within the Patient Data Pane.

Voice and Messaging

KUDUwave™ software allows for SMS and/or voice communication, here is where you will add the details.

Add the phone numbers in the fields provided*. Select “Add another” to add additional numbers, to remove press “Delete”.

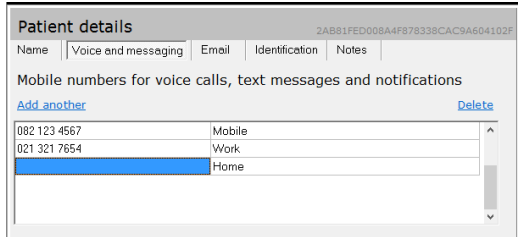

The screenshot shows the 'Patient details' interface with the 'Voice and messaging' tab selected. The page title is 'Patient details' and the patient ID is '2AB81FED008A4F878338CAC9A604102F'. Below the tabs, there is a section titled 'Mobile numbers for voice calls, text messages and notifications'. It includes an 'Add another' link and a 'Delete' link. A table lists two mobile numbers: '082 123 4567' (Mobile) and '021 321 7654' (Work). A third row is highlighted in blue, indicating it is selected.

***Note:** Include *country and area codes* with telephone numbers. **Do not add +** before the country code.

Email

Email addresses linked to your patient can be stored here. Select the Email tab to add email addresses. Select “Add another” to add additional email addresses, and “Delete” to delete email addresses.

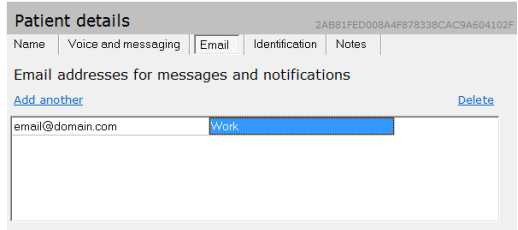

The screenshot shows the 'Patient details' interface with the 'Email' tab selected. The page title is 'Patient details' and the patient ID is '2AB81FED008A4F878338CAC9A604102F'. Below the tabs, there is a section titled 'Email addresses for messages and notifications'. It includes an 'Add another' link and a 'Delete' link. A table lists one email address: 'email@domain.com' (Work). A second row is highlighted in blue, indicating it is selected.

Identification

Occasionally, you will need to add additional identity numbers for verification such as employee ID, Social Security or medical insurance details. Here is where this can be done. Select Identification to add additional types of identity details for the patient.

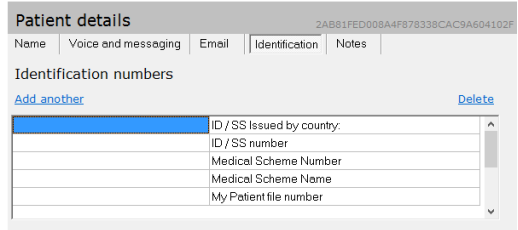

The screenshot shows the 'Patient details' interface with the 'Identification' tab selected. The page title is 'Patient details' and the patient ID is '2AB81FED008A4F878338CAC9A604102F'. Below the tabs, there is a section titled 'Identification numbers'. It includes an 'Add another' link and a 'Delete' link. A table lists four identification numbers: 'ID / SS Issued by country', 'ID / SS number', 'Medical Scheme Number', and 'My Patient file number'. A second row is highlighted in blue, indicating it is selected.

Add the identity details to the relevant field provided, or click “Add another” to add additional forms of identification, and “Delete” to remove them.

Notes

Notes relating to the patient's demographics can be added under the Notes tab. Notes regarding tests are discussed later.

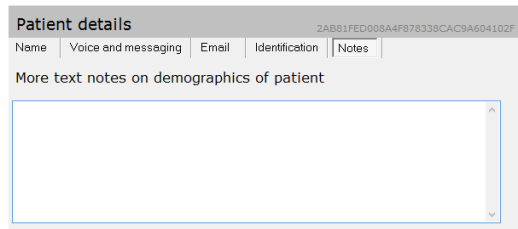

The screenshot shows the 'Patient details' interface with the 'Notes' tab selected. The page title is 'Patient details' and the patient ID is '2AB81FED008A4F878338CAC9A604102F'. Below the tabs, there is a section titled 'More text notes on demographics of patient'. It includes a large text area for entering notes.

Notes and Tests

KUDUwave™ software bundles notes and tests within a single function. To add a new note or test click on **+ Note / Test** to get access to the following options:

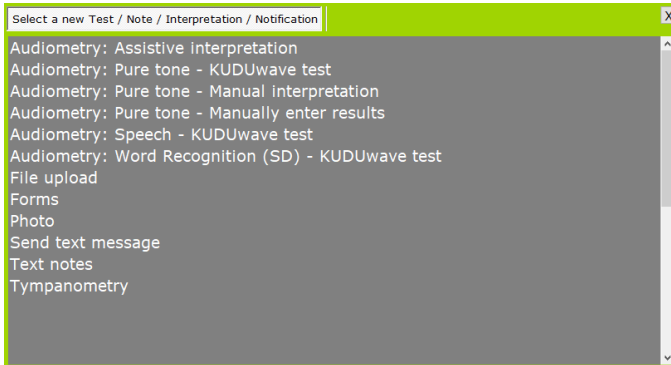

All audiometry listed items are discussed in the "[Working with clinical tests](#)" section. Request the Tympanometry User Manual to find out more about this added feature of the KUDUwave.

File upload

It may be necessary to upload additional digital documents to your patients records such as; clinical notes or old audiograms. To do this, select "File upload" from the **+Note / Test** menu.

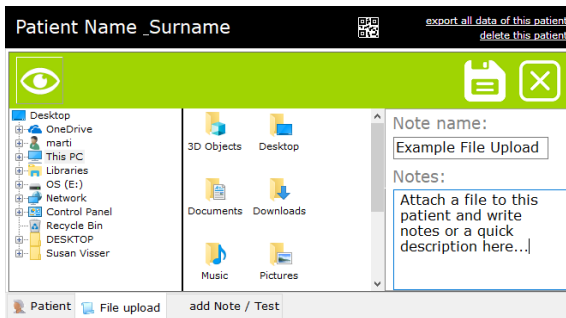



Browse to the file you would like to upload to the patient profile, select it, name it and provide some details about the file you are uploading.

Click the save icon  to upload the file.

Date and time	Significance	Type	Signed
2018/10/09 13:08	None	File upload - KUDUwave software Backup 20	

Forms

The KUDUwave software comes with built-in patient questionnaires to help supplement your test results. Click on any of the listed questionnaires, then click on the “Next” arrow to fill it in.

Occupational Health Hearing history

- Occupational Health General history
- Medical certificate of fitness - Construction regulation 2014 (ZA Act 85 of 1993)
- Monitoring of hearing and balance problems in ototoxicity for DR-TB (Baseline)
- Monitoring of hearing and balance problems in ototoxicity for DR-TB (Follow-up)
- Monitoring of hearing and balance problems in ototoxicity for DR-TB (Exit)

Photo

To take a photograph of the patient, select “Photo” from the +Note / Test menu. Your computer’s camera will automatically start.

If it does not, select 

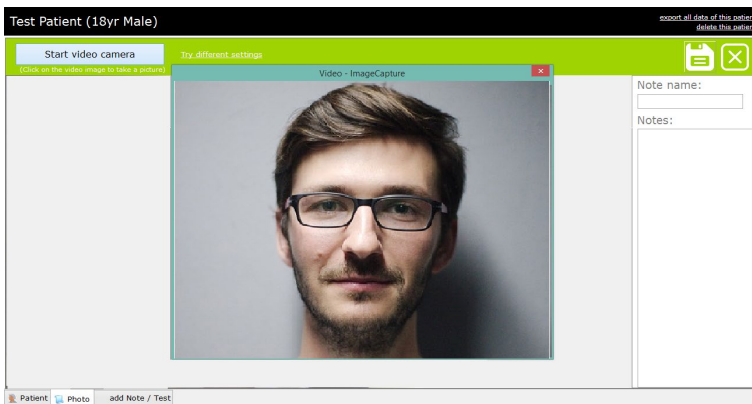

If the image is in black and white, select “Try different settings”. If you are happy with the image click anywhere on the image to take the photograph. You can make a note about the file upload in the “Note” field.



Click  to save. The photo will now be available in the patient profile.

Click  to cancel and go back to the patient profile

Send a Text Message



In order to send a text message from the system, you need to be connected to the internet. Contact eMoyo to set this feature up for you. First, select "Send text message" from the **+Note / Test** menu.

From the drop down menu, select the number to which you want to send a text message. This number would have been entered in the patient's details under "Voice and messaging".

Type your message and select  to save and send, or  to cancel the message. A record of the sent sms will be saved in the patient history.

Text Notes

Select "Text notes" from the **+Note / Test** menu. Enter the name of the note and enter the note text.

Select  to save or  to cancel the note. The note is saved in the patient history.

Patient History

The Patient Data Pane also contains a panel called History. Here, all Notes/tests will be listed by date.

Date and time	Significance	Type
2018-03-01 17:02:42	None	Text notes - Text Note 2
2018-03-01 17:02:24	None	Text notes - Text Note 1

Patient Data Storage

Data is obfuscated locally and only accessible/readable via the KUDUwave software. No data can be deleted, it is only hidden from the end user in the software. The patient database is encrypted and stored in hidden folders under GUIDs that are linked to the respective tests or patients.

eMoyo does not take responsibility for the transmission of data off the PC, if the end user requires any backup solutions (cloud or hardware) it is done at their own risk. If third party integrations are utilised then it is the responsibility of the third party application to handle the data. Unless an agreement is made with eMoyo and the risks of data transferral are appropriately mitigated.

Exporting Patient Data

Exporting a Single Patient's Data

From within a patient profile, click on “export all data of this patient” at the top right corner of the patient management screen. This will bring up a dialogue box. Select where you would like to save the patient data, and click “Save”.

Note: This exported data can only be viewed if imported back into the KUDUwave software.

Exporting Multiple Patients' Data

From within a folder, you can export multiple pure tone test results for all patients within a specific date range. In the folder view, click “Export”, select a date range and then click “Export all KUDUwave Pure Tone results in this folder”.

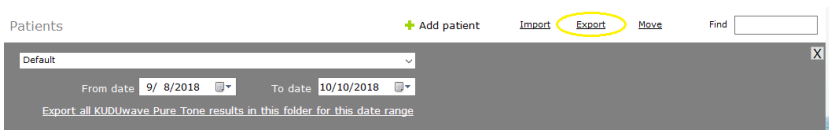
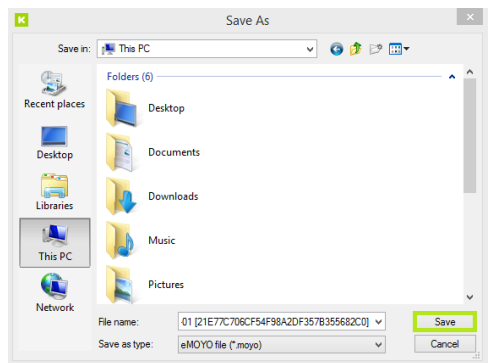
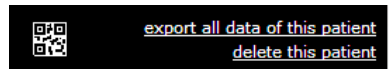

Select where you would like the file to be saved and click “Save” to finish. The software will inform you of the progress of the export.

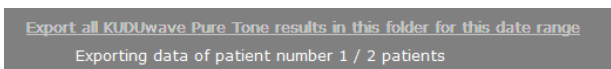

Note: This exported data is saved in csv format and must be opened as a spreadsheet.

Importing Patient Data

To import patient data, select a folder from the Folder Management Pane and click “Import”. You have a choice to import a single patient or multiple from a spreadsheet. Select the option you would like, locate the file in the browser and click “Open”.

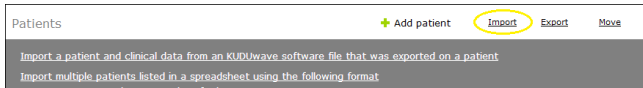

Import a Single Patient from KUDUwave Software File

You can import a patient file which was exported from the KUDUwave software in a “.moyo” format.

Click on “[Import a patient and clinical data from an KUDUwave software file that was exported on a patient](#)”.

Find and select the “.moyo” file, then click “Open” to import it.

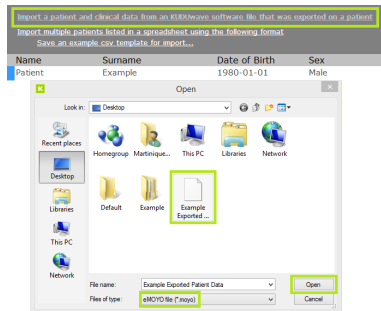

Import Multiple Patients from a Spreadsheet

You can import multiple patients into a folder from a spreadsheet that is saved in a “.csv” format.

Select the folder you wish to assign all your patients into. Click on “[Import multiple patients listed in a spreadsheet using the following format](#)”. Select the “.csv” file and click “OK”.

Note: This file upload cannot be undone! Make sure you have selected the correct folder!

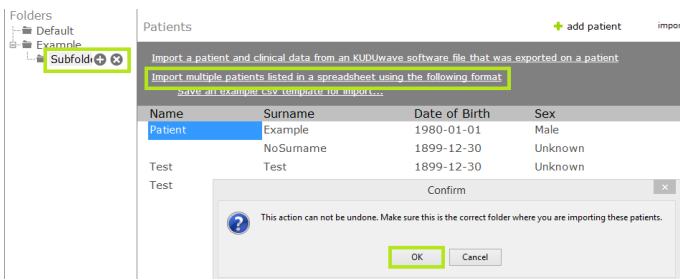

Browse your PC folders, select the csv file and upload. An example file can be downloaded by clicking on “[Save an example csv template for import...](#)”. Your spreadsheet must include all headings in this order.

Searching and Finding Patients

Search

Recent patients Search

The search function can only be accessed from the Home screen. Search for patients using either: Name, Surname or Date of Birth. Begin typing in the search field and the software will automatically start bringing up possible matches.

Find

[+ Add patient](#) [Import](#) [Export](#) [Move](#) Find

The find function can only be accessed from within a folder. Search for patients using either: Name or Surname. Begin typing in the search field and the software will automatically start bringing up possible matches.

QR Codes

Your KUDUwave software has the ability to automatically generate a QR code for each patient that you create. This code will appear on all reports associated with this patient. To view the QR code assigned to them click on the box in the right hand corner of the patient profile, or view any record saved in their history.

Petra Haselmaier (34yr) export all data of this patient delete this patient

Patient details

Name* Surname*

ID no. Passport no.

Date of Birth* Sex*

Company* Department*

Job title* Number

History [+ Note / Test](#)

Date and time	Significance	Type	Signed
---------------	--------------	------	--------

QR Code

[9072303484A3400087F2C5ACFD095CC1](#)

From this view you can print a page of these codes, copy the unique code associated to this QR code and assign a different QR code to your patient.

On the home screen you can scan this code on any of the printed reports and the software will take you directly to this patient's profile again.

Click on [Scan patient QR code](#) to open the webcam view and hold the QR code in front of the camera lense of the computer. Once the code has been registered, click search and it will take you to the patient profile.

Working with Clinical Tests

Create a New Test

Ensure that your KUDUwave™ is plugged in before attempting to initiate a test.

To add a new test click on  Note / Test to get access to the following options:

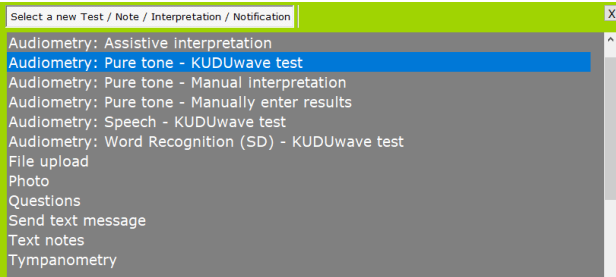

Choose the test you want to do:

Select “Audiometry: Pure tone - KUDUwave test”.

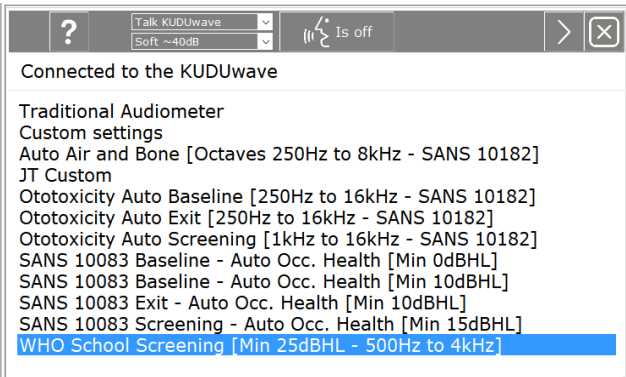

Select the type of protocol to perform from the list and then press “Next”.

This will start the “macro”, an automatic testing protocol with preloaded settings that meet the standards mentioned in the label.

Alternatively, select “Custom Settings” to create a macro with your own settings.

If at any stage during a test you would like to communicate with the patient, use the “Talk Kuduwave” button.



Click to turn on .
Click again to turn off.

Create a New Test Macro

Should you wish to customise your audiometry test, make sure the folder has default settings. You can check this by selecting the folder and noting the folder type in the top right hand corner. To change this refer to the Working with Folders section.

Select a patient in this default folder and click on

+ Note / Test

Select one of the tests listed in the + Note/Test menu. You will then see this menu:

Traditional Audiometer

Custom settings

Auto Air and Bone [Octaves 250Hz to 8kHz - SANS 10182]

Ototoxicity Auto Baseline [250Hz to 16kHz - SANS 10182]

Ototoxicity Auto Exit [250Hz to 16kHz - SANS 10182]

Ototoxicity Auto Screening [1kHz to 16kHz - SANS 10182]

SANS 10083 Baseline - Auto Occ. Health [Min 0dBHL]

SANS 10083 Baseline - Auto Occ. Health [Min 10dBHL]

SANS 10083 Exit - Auto Occ. Health [Min 10dBHL]

SANS 10083 Screening - Auto Occ. Health [Min 15dBHL]

WHO School Screening [Min 25dBHL - 500Hz to 4kHz]

Each macro listed here is programmed to conduct testing protocols which adhere to the mentioned standard. Select the type of macro you wish to conduct.

Note: The macro you select **must** meet the standards which are required in your field. That is, Occupational Therapists must choose an already existing Occ. Health protocol, so that **all standards will be copied over** to the new macro which will be created.

Select "Add a new Test setup" at the bottom of the screen.

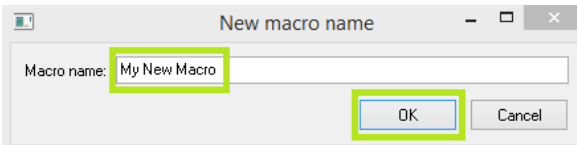
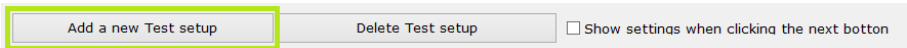

Enter the new name for this Macro. Select "OK"

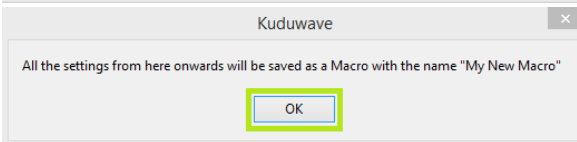

The Start Page will show you the automatic settings which have been copied from the previous Macro you selected.

Start page

Simulate a sound booth (Monitor the ambient noise)

Maximum permissible ambient sound pressure levels for AC and Occluded BC to test accurately to 0 dBHL

	125	250	500	1000	2000	4000	8000	Hz
<input type="radio"/> ANSI/ASA S3.1 for KUDUwave headset	58	58	55	49	46	54	52	
<input checked="" type="radio"/> SANS-10182 screening for KUDUwave headset	74	74	61	56	55	65	64	
<input type="radio"/> SANS-10182 diagnostic for KUDUwave headset	56	56	59	56	55	65	64	
<input type="radio"/> BS 6655 / EN 26189 / ISO 6189 for KUDUwave headset	69	68	57	52	49	58	58	
<input type="radio"/> OSHA for KUDUwave headset			76	65	59	77	83	
<input type="radio"/> ACC Guidelines NZ Nov 2012 for KUDUwave headset	83	78	67	58	52	67	67	

dB SPL

Simulate an audiometer (Maximum and minimum thresholds)

		125	250	500	750	1k	1.5k	2k	3k	4k	6k	8k	Minimum
<input type="radio"/> Type 1* Research Audiometer except for thresholds in maroon	Air** Bone***	-50 -	70 25	90 45	90 45	90 55	90 60	90 60	90 60	90 50	80 -	70 -	-10 -10
<input type="radio"/> Type 2* Clinical Audiometer	Air**	60	80	100	-	100	100	100	100	100	90	80	-10
<input checked="" type="radio"/> Type 3* Diagnostic Audiometer	Air**	-	70	90	-	90	-	90	90	90	80	70	-10
<input type="radio"/> Type 4* Screening Audiometer	Air**	-	70	60	-	60	-	60	60	60	60	-	0
<input type="radio"/> Type 4* Screening Audiometer that can test to 70dBHL including 8kHz	Air**	-	70	70	-	70	-	70	70	70	70	70	0

* IEC 60645-1 classification ** Maximum hearing levels for Air Conduction *** Maximum hearing levels for Bone Conduction

Extended high frequencies

Extended High Frequencies are not enabled on this Audiometer. Please contact your supplier if you would like to upgrade to this functionality. (Extended High Frequencies go up to 16kHz)

Threshold seeking method

Manual

Automatic setup:

Shortened Ascending method (ISO 8253-1) ▾

Type of tone

Pure tone

Warble tone

Tone duration

500 milli seconds (ms)

Tones are always presented at this fixed duration

Stenger offset: 10

Show Audiometer info

Click  to move on to the “Setup for automatic testing page”, it will give you access to specific features you can choose to be tested in this new macro.

Setup for automatic testing page

Frequencies to test (Hz):

Test these AC frequencies Left

<input type="checkbox"/> 125	<input checked="" type="checkbox"/> 2k	<input type="checkbox"/> 9k
<input type="checkbox"/> 250	<input checked="" type="checkbox"/> 3k	<input type="checkbox"/> 10k
<input checked="" type="checkbox"/> 500	<input checked="" type="checkbox"/> 4k	<input type="checkbox"/> 11.2k
<input type="checkbox"/> 750	<input checked="" type="checkbox"/> 6k	<input type="checkbox"/> 12.5k
<input checked="" type="checkbox"/> 1k	<input checked="" type="checkbox"/> 8k	<input type="checkbox"/> 14k
<input type="checkbox"/> 1.5k	<input type="checkbox"/> 16k	

Test these AC frequencies Right

<input type="checkbox"/> 125	<input checked="" type="checkbox"/> 2k	<input type="checkbox"/> 9k
<input type="checkbox"/> 250	<input checked="" type="checkbox"/> 3k	<input type="checkbox"/> 10k
<input checked="" type="checkbox"/> 500	<input checked="" type="checkbox"/> 4k	<input type="checkbox"/> 11.2k
<input type="checkbox"/> 750	<input checked="" type="checkbox"/> 6k	<input type="checkbox"/> 12.5k
<input checked="" type="checkbox"/> 1k	<input checked="" type="checkbox"/> 8k	<input type="checkbox"/> 14k
<input type="checkbox"/> 1.5k	<input type="checkbox"/> 16k	

At the end of AC, redo the first frequency that was tested again

Then redo all AC frequencies up to 8kHz with thresholds worse than dB HL

Then also test the following AC frequencies if any one AC threshold is worse than dB HL

125 250 500 750 1k 1.5k 2k 3k 4k 6k 8k

Then redo all AC frequencies with thresholds worse than dB HL where noise levels were too loud

Then redo all AC frequencies with thresholds worse than dB HL

and where Orange and Green overlapped more than dB

Then add these BC frequencies for each AC frequency thresholds that is greater or equal to dB HL

250 500 750 1k 1.5k 2k 3k 4k *Automatic masking*

Then also test the following BC frequencies if any one AC threshold is worse than dB HL

250 500 750 1k 1.5k 2k 3k 4k *Automatic masking*

Always test these BC frequencies Left *Automatic masking*

<input type="checkbox"/> 250	<input type="checkbox"/> 1.5k
<input checked="" type="checkbox"/> 500	<input checked="" type="checkbox"/> 2k
<input type="checkbox"/> 750	<input checked="" type="checkbox"/> 3k
<input checked="" type="checkbox"/> 1k	<input checked="" type="checkbox"/> 4k

Always test these BC frequencies Right *Automatic masking*

<input type="checkbox"/> 250	<input type="checkbox"/> 1.5k
<input checked="" type="checkbox"/> 500	<input checked="" type="checkbox"/> 2k
<input type="checkbox"/> 750	<input checked="" type="checkbox"/> 3k
<input checked="" type="checkbox"/> 1k	<input checked="" type="checkbox"/> 4k

Then redo all BC frequencies up to 4kHz with thresholds worse than dB HL

Then redo all BC frequencies with thresholds worse than dB HL where noise levels were too loud

Prompt to apply the bone conductor when bone conduction testing starts (Also play a tone)

Block tones from being presented if the noise levels are too loud for seconds

Default test order:

Minimum testable threshold for each frequency

	Hz	125	250	500	750	1000	1500	2000	3000	4000	6000	8000	
Air conduction		<input type="text" value="0"/>	<input type="text" value="0"/>	<input type="text" value="0"/>	<input type="text" value="0"/>	<input type="text" value="0"/>	<input type="text" value="0"/>	<input type="text" value="0"/>	<input type="text" value="0"/>	<input type="text" value="0"/>	<input type="text" value="0"/>	<input type="text" value="0"/>	dB HL
Bone conduction		<input type="text" value="0"/>	<input type="text" value="0"/>	<input type="text" value="0"/>	<input type="text" value="0"/>	<input type="text" value="0"/>	<input type="text" value="0"/>	<input type="text" value="0"/>	<input type="text" value="0"/>	<input type="text" value="0"/>	<input type="text" value="0"/>	<input type="text" value="0"/>	dB HL
	Hz	9000	10000	11200	12500	14000	16000						
Air conduction		<input type="text" value="0"/>	<input type="text" value="0"/>	<input type="text" value="0"/>	<input type="text" value="0"/>	<input type="text" value="0"/>	<input type="text" value="0"/>						dB HL

Maximum testable threshold

Use the maximum thresholds that this audiometer can test to

Use this maximum level dB HL

Next frequency start threshold level

dB HL

Delay before randomization delay

ms

Randomization delay before next tone

Enable randomised delay

Between & ms

You can select frequencies for each ear, for Air Conduction (AC) and Bone Conduction (BC) testing.

You can also alter the randomized delay between tones.

Click  to move on to the "Conditioning page".

Conditioning

Conditioning page

Left

Present tone Mask

Left loudness setting

- 40 dBHL (Soft)
- 60 dBHL (Normal)
- 80 dBHL (Loud)
- 100 dBHL (Very loud)
- 110 dBHL (Extremely loud)

1000 Hz

Right

Present tone Mask

Right loudness setting

- 40 dBHL (Soft)
- 60 dBHL (Normal)
- 80 dBHL (Loud)
- 100 dBHL (Very loud)
- 110 dBHL (Extremely loud)

Automatic Wait Time (milliseconds)

2500

Side to start

- Left
- Right

This is the conditioning page. It allows you to play a sound to the patient and see how long they take to respond. This tests their response time and conditions them to the test environment.

Tones will be presented to them and they must press the response button to indicate they have heard the tone. If the patient does not respond in time, a pop up message will say: "Button not pressed in time". Explain the testing process again, e.g. "When you hear the sound, quickly press the response button and release."

If the patient was too slow in pressing the button, a pop up message will say: "Pressed bit too slow for automatic wait time". The wait time is how long it takes for patients to press the button. This is automatically set to 2,5 seconds (2500ms). You can extend or shorten this time by clicking on: "Increase wait time" or "Decrease wait time".

There are two options for patient conditioning: Manual and Automatic.

Auto conditioning

To switch between the two modes click:

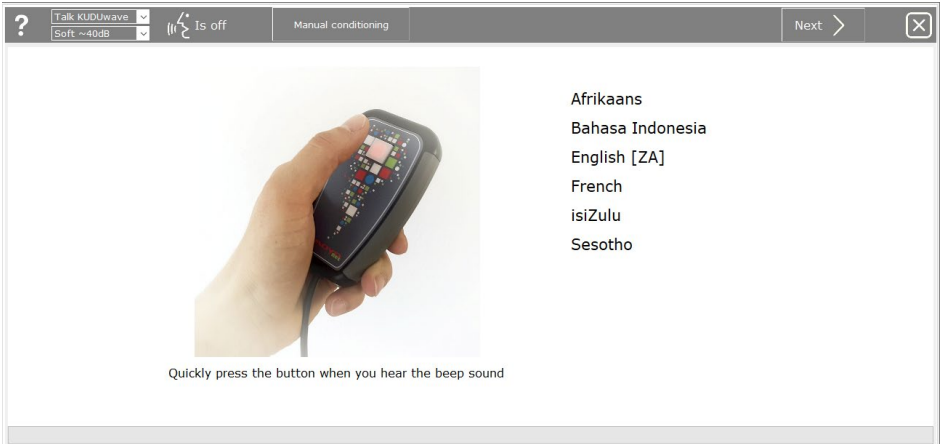

This is the Automatic Conditioning page. Here you can select the preferred language of the patient. The conditioning process will now be explained to them in that language.

In Manual mode, begin conditioning at 40 dBHL and increase the intensity until the patient responds. This gives you an indication of where to begin testing.

Condition the patient for masking by selecting “Mask”. This will play white noise to the ear selected on the conditioning page and present the toneto the opposite ear.

Once both ears have been conditioned, you will know the patient understands how the test is conducted. Select “Next” .

Conducting a Clinical Test

Automatic Test

The automated test will start running immediately after conditioning is completed. Wait for the test to complete and select “Save” .

Manual Test

After conditioning the patient, click . Now manual testing can be performed.

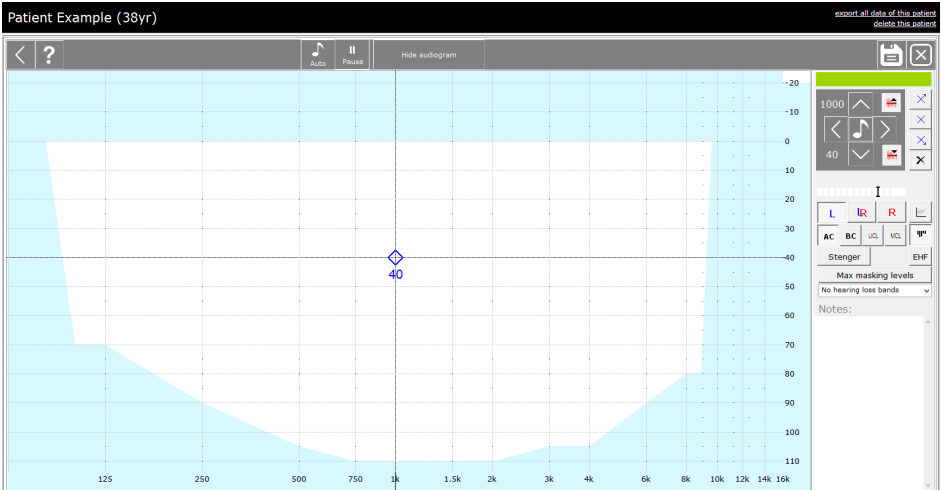

Use the keypad to move the cursor across the plane.

1000 To present a tone at the set frequency (1000) and intensity (40), click .

To **increase** intensity (to make it **louder**) click .

40 To **decrease** intensity (to make it **softer**) click .

To **increase** frequency click , to **decrease** frequency click .

The blue screen is for the left ear test and the red screen for the right ear. Use these buttons to switch between left and right or to show both.

After a tone is presented, this bar will become coloured as you wait for the patient to respond. It will be green and show a thumbs up if the patient responds in time.

If the patient was too slow it will turn orange and show a thumbs down. If the patient presses the response button without a tone being presented, a grey spot will mark the screen.

Use these keys to move the masking level. The blue crosses/red circles on the side bar are to mark the minimum plateau threshold , threshold frequency and the points the patient did not respond .

Use to delete.

To switch between air conduction and bone conduction testing, use these buttons.

The KUDUwave will automatically mask the ears when performing bone conduction tests.



When counselling a patient or person interested in the testing results, use this button to view the speech area of the patient. On the screen it will show the various consonants and vowels available to the patient and also shows the intensity of sounds i.e. a baby crying or a dog barking.

Another feature you can use is applying hearing loss bands to the screen. To view the hearing loss bands, click on **No hearing loss bands** and select one of the options in the menu.

This is what the screen will look like if you selected Clark Degrees.

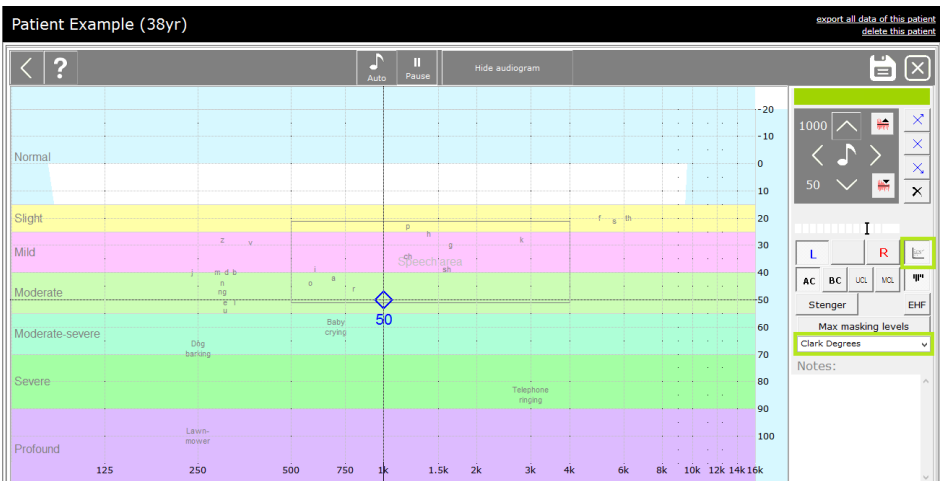

The **?** will bring up the Help page and it will show you shortcut keys to perform tests quicker.

Speech Reception Threshold (SRT) Testing

To conduct a SRT test, select the “Speech - KUDUwave test” option from the New Test Menu.

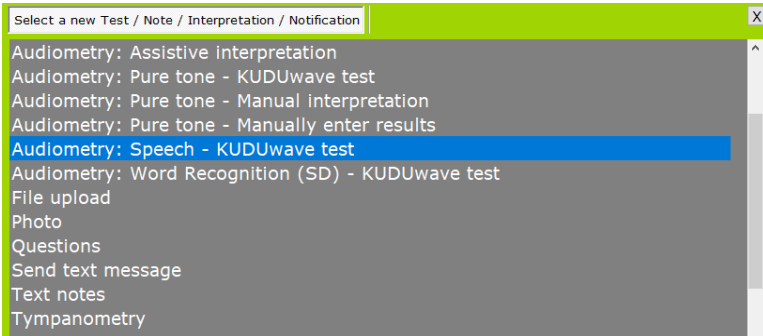

Then select the list of words read in the specified language you wish to use.

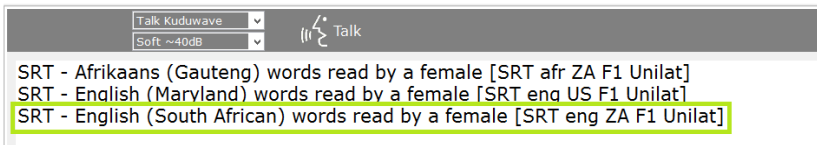

Select which ear you want to begin testing at the specified intensity level.

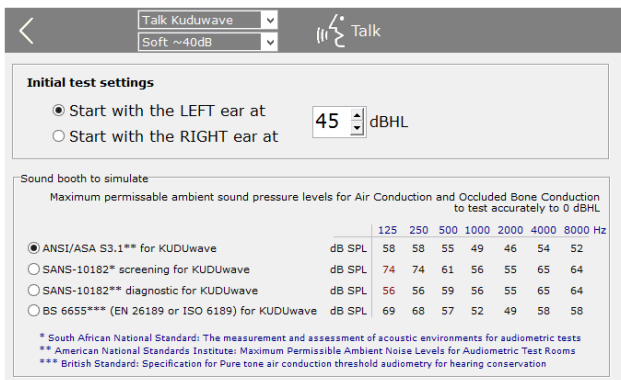

The SRT page will open and automatically read the words to the patient once you select the play button on the control panel.

Example Patient (24yr Male)

export all data of this patient
delete this patient

Talk Kuduwave
Soft --40dB

Left	L	dB	
Hotdog	45	✓	✗
Whitewash	40	✓	
Woodwork	35	✓	
Inkwell	30	✓	
Oatmeal	25	✓	
Mousetrap	20		✗
Doormat	25		✗
Playground	30	✓	
Daybreak	25	✓	
Toothbrush	20		✗
Railroad	25		✗
Sunset	30	✓	
Mushroom	25	✓	
Farewell	25		
Pancake			
Eardrum			
Stairway			
Headlight			
Northwest			
Hardware			
Horsehoe			
Cowboy			

Controls

Noise compliant (67dBHL)

Correct

Incorrect

Auto Softer Louder

Pancake

Notes

Left Right

30 SRT -20

-20 UCL -20

-20 MCL -20

0 Dichotic % 0

Patient Audiometry: Speech - KUDUwave test add Note / Test

Correct

Incorrect

Auto Softer Louder

Click the “Correct” button with the thumbs up if the patient recites the word correctly. In automatic mode, the next word will be read to the patient at 5 dBs softer. Use the “Incorrect” button with the thumbs down if the patient did not recite the word correctly or did not hear the word. If incorrect, the next word will be read at 5 dBs louder.

Use the up and down keys to navigate through the word list. The “Play” button will read the word to the patient and the loudness of the word can be changed by clicking the “Softer” or “Louder” buttons.

Click the “Next” button to continue once testing of the left ear is complete. Select the Right ear option and specify the Intensity level testing should begin at.

What would you like to do next?

Next, the LEFT ear at

Next, the RIGHT ear at

45 dBHL

The same procedure must be done for the Right ear. Once complete click “Save”.

Speech in Noise Testing with QuickSIN

The assessment of speech in noise provides important diagnostic information which the pure tone audiogram cannot reliably predict. The KUDUwave provides speech in noise testing through its integration with QuickSIN. To access QuickSIN, add a patient or select an already existing patient. Click on the green button: “+Note/Test” and from the menu, select the Audiometry: Speech - KUDUWave test.

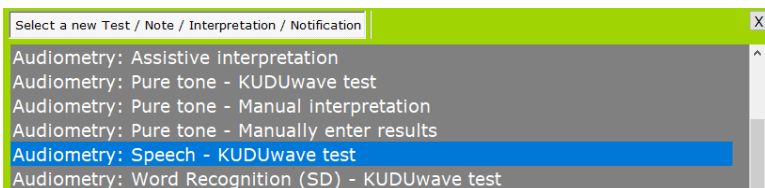

Select QuickSIN from the next test menu.

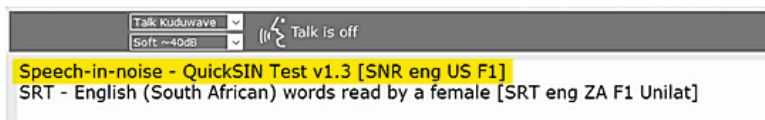

To begin, select the ear you wish to start with and set the appropriate intensity level. Then click Next.



Click on List 1 to view the first list of sentences which will be tested.



How Speech in Noise works

A list of 6 sentences with 5 keywords per sentence, is presented within a babble noise. The sentences are presented at a signal to noise ratio which decreases in increments of 5dB's, from 25 (which is very easy), to 0 (which is very difficult).

To begin the test, press the play button. 

Once the patient has responded with what they have heard, score the results by counting the number of keywords underlined that the patient got correct.

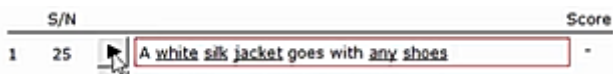

The KUDUwave has two different scoring pads which you can choose from.



The above scoring section allows you to click on the number (score from 0 to 5) and the KUDUwave will immediately begin playing the next sentence.

The below scoring section allows you to click on the number (score from 0 to 5) and the KUDUwave will wait until you press play for the next sentence or to save the test result.

There are a total of 12 lists each with 6 sentences.

Speech Discrimination (SD) Testing

To conduct a SD test, select the “Speech Discrimination - KUDUwave test” option from the New Test Menu.

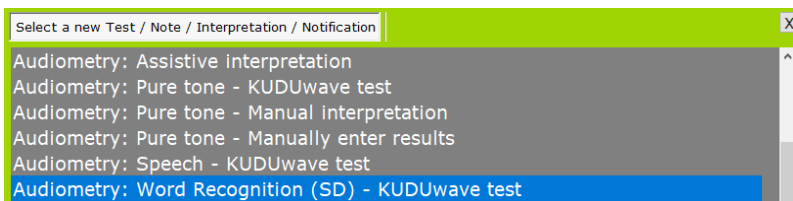

Select the preferred word list you wish to use.

- Afrikaans word list read by a man [SD afr ZA M1]
- Maryland CNC English word list read by a man [SD eng US M1]
- Pedi word list read by a man [SD mso ZA M1]
- South African English word list read by a man [SD eng ZA M1]
- Zulu word list read by a man [SD zul ZA M3]

Select which ear and intensity to begin testing with and click the next arrow.

Start threshold:

Present the first word list in the LEFT ear at dBHL
 Present the first word list in the RIGHT ear at

Sound booth to simulate

Maximum permissible ambient sound pressure levels for Air Conduction and Occluded Bone Conduction to test accurately to 0 dBHL

	125	250	500	1000	2000	4000	8000	Hz
<input checked="" type="radio"/> ANSI/ASA S3.1** for Kuduwave headset	58	58	55	49	46	54	52	dB SPL
<input type="radio"/> SANS-10182* screening for Kuduwave headset	74	74	61	56	55	65	64	dB SPL
<input type="radio"/> SANS-10182** diagnostic for Kuduwave headset	56	56	59	56	55	65	64	dB SPL
<input type="radio"/> BS 6655*** (EN 26189 or ISO 6189) for Kuduwave	69	68	57	52	49	58	58	dB SPL

* South African National Standard: The measurement and assessment of acoustic environments for audiometric tests
 ** American National Standards Institute: Maximum Permissible Ambient Noise Levels for Audiometric Test Rooms
 *** British Standard: Specification for Pure tone air conduction threshold audiometry for hearing conservation

The SD testing page will open and each word will be presented at the selected dB level.

Example Patient (24yr)

Talk Kuduwave | Soft -40dB | Talk

Test progress	Word	L	dB	✓	✗	Replied
Left	burn		30			
dBHL Progress	lot		30			
1	sub		30			
2	home		30			
3	dime		30			
4	witch		30			
Right	keen		30			
dBHL Progress	yes		30			
1	boat		30			
2	sure		30			
3	hole		30			
4	door		30			
	kite		30			
	sell		30			
	nag		30			
	take		30			
	fall		30			
	weak		30			
	death		30			
	love		30			
	tough		30			
	gap		30			

Controls: Noise complaint (-59dBHL), Correct, Incorrect, Auto, Capture words

Notes

Mark each word correct or incorrect with the thumbs up and down buttons. To change the dB level for the following words click on the next arrow.

Talk Kuduwave | Soft -40dB | Talk

Test progress

Left

dBHL Progress

1 30 4/4 100%

2 20 2/4 50%

3 -10 0/0 0%

4 -10 0/0 0%

Right

dBHL Progress

1 -10 0/0 0%

2 -10 0/0 0%

3 -10 0/0 0%

4 -10 0/0 0%

What would you like to do next?

Present the next word list in the LEFT ear at dBHL
 Present the next word list in the RIGHT ear at
 Restart the current test at

Change the dB level and click the "Next" arrow again. Continue testing at the new dB level.

Test progress	Word	L	dB	✓	✗	Replied
Left	juice		20	✓		
	mill		20	✓		
	chief		20			
	keg		20		✗	
	cloud		20		✗	
	loaf		20			
	fail		20			
	bought		20			
	pick		20			
	thought		20			
Right	hate		20			
	deep		20			
	soap		20			
	tool		20			
	four		20			
	rain		20			
	shack		20			
	white		20			
	shawl		20			
	dab		20			
gaze		20				
pike		20				

Click the "Next" arrow again and select the right ear to continue testing the right ear. Click "Save" at the end of the test.

Viewing Notes and Tests

Selecting a record in the history panel will open the file in the Test Data Pane (5).

Now you can view , print  or save a pdf  to download.

Patient Example (38yr) export_all_data_of_this_patient
delete_this_patient

Patient details

21E77C706CF34F98A2DF357B355682C0

Name: Patient, Surname: Example
 ID no.: 123456789, Passport no.:
 Date of Birth: 1980/01/01, Sex: Male
 Company: Hospital / Clinic / School, Department/Ward: Ward / OPD / Grade
 Job title: Employee no / File no / Scholar no, Number: 1

History + Note / Test

Date and time	Significance	Type
2018-03-02 09:27	None	Audiometry: Pure tone - KUDUwave test
2018-03-02 09:25	None	Audiometry: Pure tone - Manual interpretation
2018-03-02 09:25	None	Audiometry: Automatic interpretation - Interpr
2018-03-02 09:25	None	Audiometry: Pure tone - KUDUwave test
2018-03-01 17:15	None	Audiometry: Automatic interpretation - Interpr
2018-03-01 17:02	None	Text notes - Text Note 2
2018-03-01 17:02	None	Text notes - Text Note 1

Audiometry: Pure tone - KUDUwave test None
Change significance

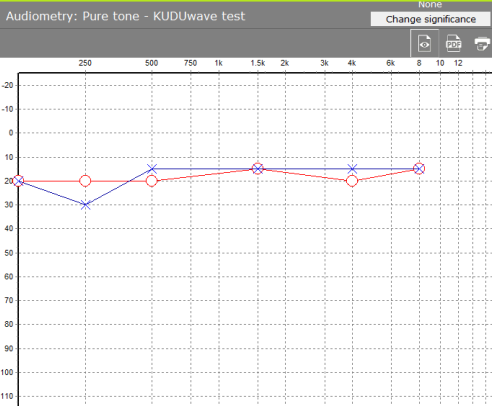

Notes made while doing test:

Test Significances

You can change the Significance of a test or note by clicking on the highlighter, or right clicking on the test in the History Pane, and selecting the appropriate label from the drop down menu.



By selecting To Interpret, you can use the Assistive Interpretation feature found in the New Test menu.

- None
- Worst
- Best
- Last significant
- General Baseline (Old)
- General Baseline
- General Baseline (Deleted)
- Comparison
- Screening
- Diagnostic
- Exit
- Deleted
- Baseline test
- PLH Baseline
- Milestone Baseline
- PLH/Milestone Baseline
- Entry
- Follow up
- Periodic
- Ototoxicity Baseline
- Ototoxicity Monitoring
- Ototoxicity Exit
- PLH Screening
- STS Screening
- PLH/STS Screening
- To interpret
- PLH Entry
- STS Entry
- PLH/STS Entry
- PLH Exit
- STS Exit
- PLH/STS Exit

Digital Signatures

To sign off a test record or report click on the pen icon. The patient must sign in the block with the red cross and the clinician / tester in the other block.



Sign this test result 📅 ✕

This is my test result

Patient Name_Surname

X

This is the hearing test of Patient Name_Surname (18yr)

eMoyo
Leave Blank
This can always be edited

Assistive Interpretation

To use the assistive interpretation feature, change the significance of the saved test to: "To interpret" or mark it as a Baseline test for PLH, Milestone or Ototoxicity.

The screenshot displays a software interface for patient management and testing. On the left, there is a 'Patient details' section with fields for Name, ID no., Date of Birth, Company, and Job title. Below this is a 'History' section with a table of dates and times. In the center, a vertical menu lists various test types, with 'To interpret' highlighted. On the right, a graph titled 'Audiometry: Pure tone - KUDUwave test' shows a line plot of hearing levels across different frequencies (250, 500, 750, 1k, 1.5k, 2k, 3k, 4k, 6k, 8, 10, 12). The y-axis represents hearing level in dB, ranging from -20 to 110. A 'Change significance' button is visible above the graph.

Click on **+ Note / Test**, and select an option from the menu for Assistive Interpretation.

The screenshot shows a dropdown menu titled 'Select a new Test / Note / Interpretation / Notification'. The menu items are:

- Audiometry: Assistive Interpretation
- Audiometry: Pure tone - KUDUwave test
- Audiometry: Pure tone - Manual interpretation
- Audiometry: Pure tone - Manually enter results
- Audiometry: Speech - KUDUwave test
- Audiometry: Word Recognition (SD) - KUDUwave test
- File upload
- Photo
- Questions
- Send text message
- Text notes
- Tympanometry

Select the type of interpretation wanted:

Next > X

Interpret the latest pure tone test marked as To interpret
 Ototoxicity interpretation
 PLH interpretation for South Africa
 Milestone baseline (Audiometric Zero) / STS interpretation
 HSE for Europe

The interpretations can now be viewed and saved from this window.

Interpretations | **Baseline calculations** | Follow-up calculations | Comparisons

PLEASE NOTE: This information is an assistive tool for clinicians

POSSIBLE FINDINGS ON THE MOST RECENT "To Interpret" SIGNIFICANT TEST DATED 2018-04-04 01:37:29 PM

- PTA for air left = 2dBHL
- PTA for air right = 2dBHL
- VPTA for air left = 1dBHL
- VPTA for air right = 1dBHL
- Binaural hearing loss (BHL) = 0%
- No Asymmetrical or Unilateral hearing loss detected
- No Bone conduction test was done to calculate the Air-bone gap
- Grade of hearing impairment (WHO):
- No hearing loss in the better ear (PTA as input)
- No hearing loss in the better ear (VPTA as input)
- Level of hearing impairment (H.E.A.R.):
- No hearing loss in the better ear
- Degree of hearing loss (Clarke, 1981):
- Normal hearing in the right ear
- Normal hearing in the left ear

POSSIBLE FINDINGS ON THE MOST RECENT "To Interpret" SIGNIFICANT TEST DATED 2018-04-04 01:37:29 PM

- PTA for air left = 2dBHL
- PTA for air right = 2dBHL
- VPTA for air left = 1dBHL
- VPTA for air right = 1dBHL
- Binaural hearing loss (BHL) = 0%
- No Asymmetrical or Unilateral hearing loss detected
- No Bone conduction test was done to calculate the Air-bone gap
- Grade of hearing impairment (WHO):
- No hearing loss in the better ear (PTA as input)
- No hearing loss in the better ear (VPTA as input)
- Level of hearing impairment (H.E.A.R.):
- No hearing loss in the better ear

Ototoxicity Monitoring with Assistive Interpretation

For ototoxicity monitoring, select the first baseline test as a “Ototoxicity Baseline” and the following test as “Ototoxicity Monitoring”.

Click on **+ Note / Test** and select the option for assistive interpretation.

Select “Ototoxicity interpretation”.

You can now view the interpretation notes and calculations for both the Baseline test, the Follow up tests and comparisons of the two.

Interpretations	Baseline calculations	Follow-up calculations	Comparisons
Baseline 04-04-2018	Difference Left and Right Air	125 250 500	750 1k 1.5k 2k 3k 4k 6k 8k
	Difference Left and Right Bone	0	0 0 0 0 0 0 0
	Difference Air and Bone Left		
	Difference Air and Bone Right		
Interpretations	Baseline calculations	Follow-up calculations	Comparisons
Follow-up 04-04-2018	Difference Left and Right Air	125 250 500	750 1k 1.5k 2k 3k 4k 6k 8k
	Difference Left and Right Bone	0	0 0 0 0 0 20 20 25 30
	Difference Air and Bone Left		
	Difference Air and Bone Right		

Interpretations	Baseline calculations	Follow-up calculations	Comparisons	
Air	Left	Baseline	125 250 500 750 1k 1.5k 2k 3k 4k 6k 8k 9k 10k 11.2k 12.5k 14k 16k MHL PTA VPTA	
		Follow-up	0 0 0 0 5 0 0 0 0 5 0 0 0 0 0 0 0 2 1	
		Difference	20 20 20 20 20 20 40 40 45 50 0 0 0 0 0 0 0 18 24	
			^ ^ ^ ^ ^ ^ ^ ^ ^ ^ ^ ^ ^ ^ ^ ^ ^ ^ ^	
	Right	Baseline	0 0 0 0 5 0 0 0 0 5 0 0 0 0 0 0 0 2 1	
		Follow-up	20 20 20 20 20 20 20 20 20 20 20 0 0 0 0 0 0 20 20	
		Difference	20 20 20 20 15 20 20 20 20 15 0 0 0 0 0 0 0 18 19	
			^ ^ ^ ^ ^ ^ ^ ^ ^ ^ ^ ^ ^ ^ ^ ^ ^ ^ ^	
	Binaural		PLH-ZA BHL	
		Baseline	1,1 0	
Follow-up		4,3 0		
Bone	Left	Baseline	250 500 750 1k 1.5k 2k 3k 4k	
		Follow-up		
	Right	Baseline		
		Follow-up		

KUDUwave™ Tympanometer

Begin a Tympanometry Test

Click on the + Note / Test button and select Tympanometry from the list.

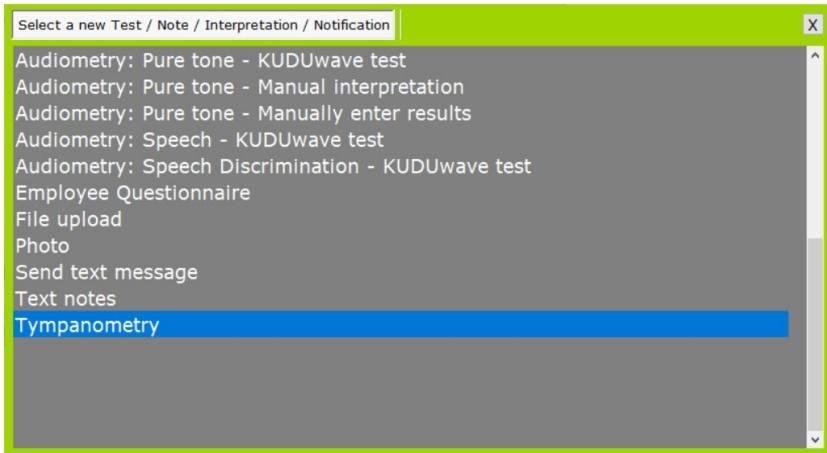

This opens up the homepage of the tympanometry software

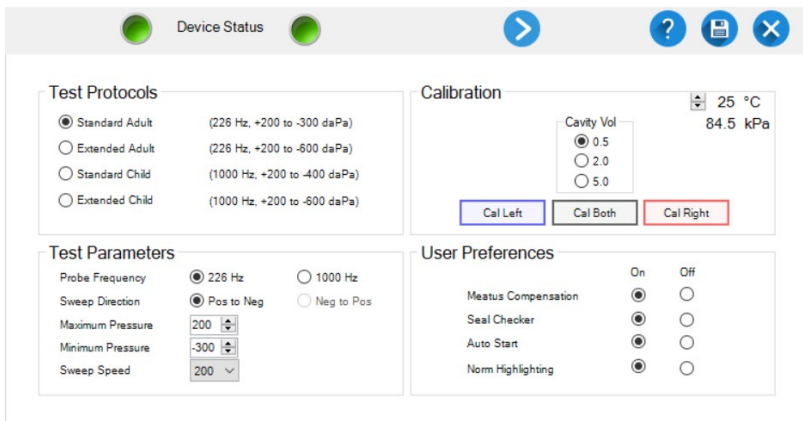

Check the Device Status

The Device Status indicates whether each side of the device is connected and ready to perform tests. The left light will indicate if the left tympanometer is ready for testing and the right light will indicate if the right tympanometer is ready.



A green light indicates that the specific side of the device is connected and ready



A red light indicates that the specific side of the device is not connected. Unplug and reconnect this side. A test cannot be conducted until the green light is on.

Select Test Protocols and Parameters

Under Test Protocols, select one of the pre-set protocols for an adult or child. Alternatively adjust the test parameters manually in the Test Parameters box.

Note: The KUDUwave is not configured to perform tests for neonates as yet.

Test Protocols	Test Parameters
<input checked="" type="radio"/> Standard Adult (226 Hz, +200 to -300 daPa)	Probe Frequency <input checked="" type="radio"/> 226 Hz <input type="radio"/> 1000 Hz
<input type="radio"/> Extended Adult (226 Hz, +200 to -600 daPa)	Sweep Direction <input checked="" type="radio"/> Pos to Neg <input type="radio"/> Neg to Pos
<input type="radio"/> Standard Child (1000 Hz, +200 to -400 daPa)	Maximum Pressure 200
<input type="radio"/> Extended Child (1000 Hz, +200 to -600 daPa)	Minimum Pressure -300
	Sweep Speed 200

Perform a Calibration Check with the Calpod

The calibration check allows for the calibration of the device to be tested at the current ambient temperature and barometric pressure. This is important for the accuracy of the device and must be performed every four hours when using the tympanometer.

Calibration

25 °C
84.5 kPa

Cavity Vol
 0.5
 2.0
 5.0



Manually enter the current ambient temperature into the top right corner (the current barometric pressure is automatically measured). Select the first cavity volume to be checked (make sure the probe is inserted into the same cavity volume in the calpod). All three cavity volumes must be processed for the check to pass and to conduct a test. Insert the probe (**without an ear-tip**) into the respective cavity volume indicated on the calpod. Press it hard to make sure it's securely inserted.



Click on the **Check Left** / **Check Right** button for the

respective side you are testing. Repeat this process for each cavity volume and on the other side. If **two calpods** are being used, both sides may be checked at the same time, just click on **Check Both**.

As the check is being done, lights appear next to the respective cavity volumes on the respective side:

-  A white light indicates that the specific cavity has been processed
-  A green light indicates that all cavities have been processed and the specific cavity passed the calibration check
-  A red light indicates that all cavities have been processed but the specific cavity failed the calibration check

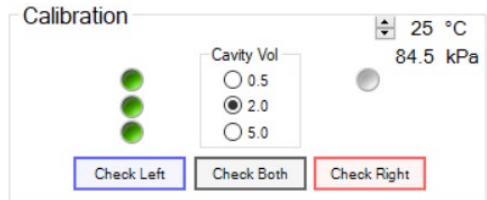

If no lights appear, a stable reading cannot be obtained. Check that the correct side is inserted into the calpods or if there is excessive ambient noise, try shield the device from it.

Select User Preferences

Various user preferences can be selected. These will be saved for next time you open the software.

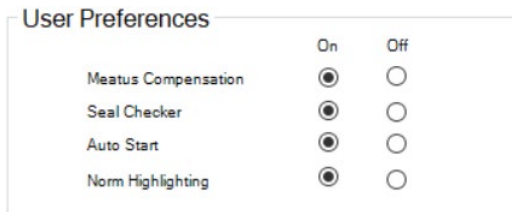

- Meatus Compensation – compensates for the admittance of the air in the ear canal
- Seal Checker – automatically checks for a seal
- Auto Start – automatically starts a sweep once a seal is obtained
- Norm Highlighting – highlights the metrics that fall outside general norms

Move to the Testing Page

To move on to testing, click on the Next button . This opens up the testing page and conducts the tympanometry test automatically according to your previously chosen settings.

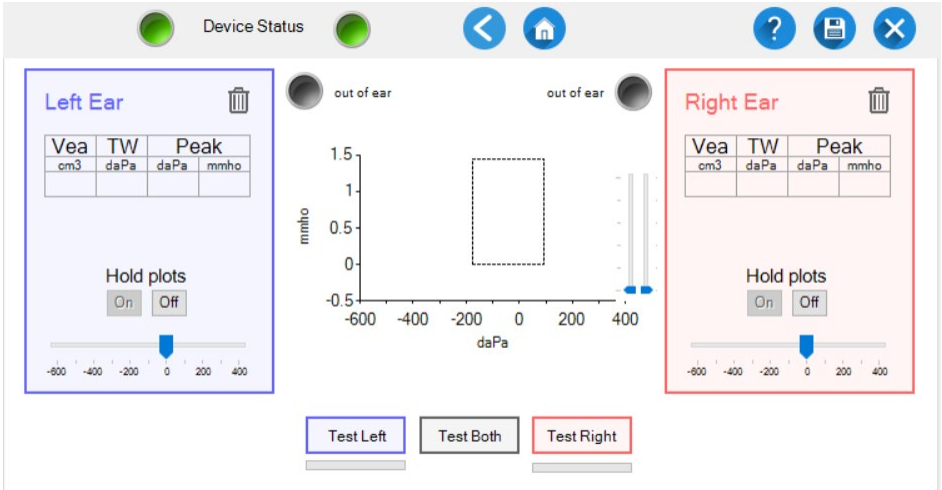

Select an Appropriate Ear-tip



Choose an ear-tip that is big enough to seal the ear canal but not too big that it hurts the patient when inserted.

Note: Do not use the foam ear-tips for tympanometry tests! The foam ear-tips do not provide an adequate seal. Only the silicone ear-tips are to be used.



Insert the Eartip Into the Ear Canal and Perform a Sweep

Place the device around the neck of the patient or on their head so that their ears are still accessible.



Insert the ear-tips into the ear canal and ensure it makes a good seal.

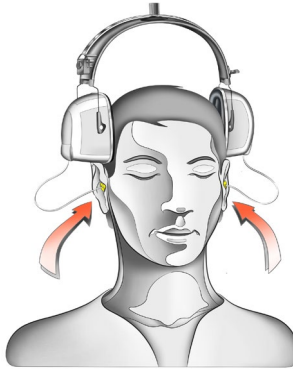

If the Seal Checker user preference is on, the status of the seal will be indicated.



A black light indicates that the probe is out of the ear or Seal Checker is off. This will show after a successful sweep.



A yellow light indicates that there is a leak and a good seal cannot be obtained. Try re-insert the ear-tip.



A green light indicates that there is a good seal and a sweep can be started.

The Seal Checker can be temporarily stopped by clicking on the light indicator.

If the **Auto Start** user preference is on, the sweep will begin as soon as a good seal has been obtained.



Run a sweep by clicking on the Test button for the respective side: Test Left or Test Right

If ear-tips are inserted into both ear canals, bilateral testing can be done by clicking: Test Both.

The progress of a test is indicated by a progress bar below the test button.



To the left and right of the the test buttons are indicator lights.

-  A purple light indicates that the pump is initialising or resetting itself.
-  An orange light indicates that audio is being played but the sweep is not underway yet.
-  A white light indicates that the sweep is underway and the data is being recorded.

The pressure in the ear canal is updated in real time and is displayed on the pressure bars on each side.



The tympanogram is updated in real-time and is displayed on the graph in the centre.

The blue line is for the left ear tympanogram. The red line is for the right ear tympanogram.

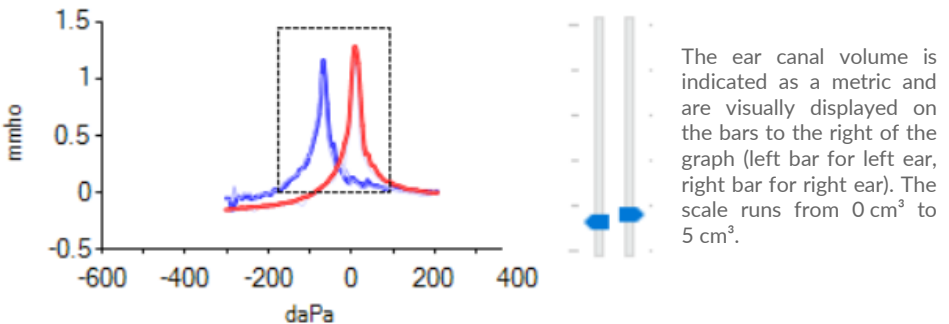

If the seal is lost during a test, the sweep is aborted and the pump is reset. To delete a tympanogram

click on the Discard button 

View the Tympanograms Metrics

Various metrics are displayed for the tympanogram for each side:

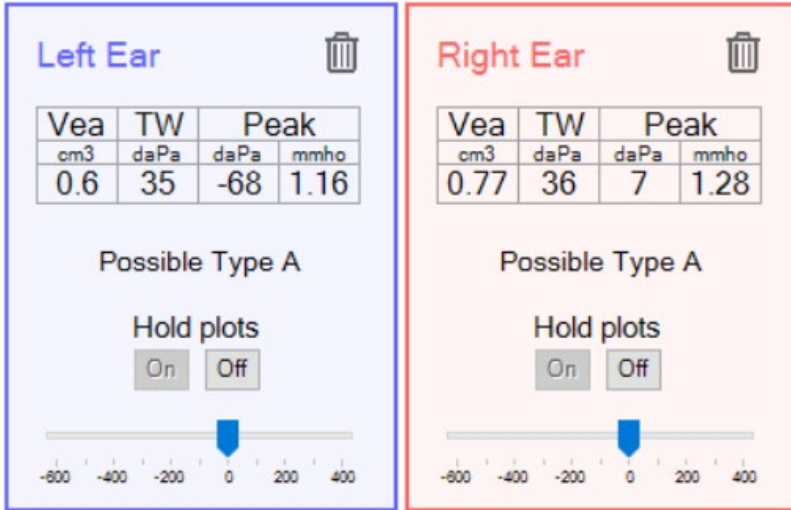

- Vea (cm³) – the equivalent volume of the ear canal
- TW (daPa) – the tympanogram width
- Peak (daPa) – the pressure at which the peak occurred
- (also called tympanometric peak pressure)
- Peak (mmho) – the peak compliance
- Type suggestion – the suggested classification of the tympanogram as a whole (note that this is just a suggestion, not a diagnosis)

Several tympanograms may be overlaid by turning on **Hold Plots**. This can be used for Eustachian Tube Function or for checking test-retest reliability. Even if many tympanograms are displayed, the metrics shown are for the latest tympanogram obtained for each side.

Page Navigation and Help

 Back  Next  Home  Help  Save  Exit

- To create a report from the current data, click on the Save button.
- To exit the tympanometry software, click on the Exit button.

Additional Tympanometer Information

Probe Dimensions: Complete Probe and Associated Tubing with End Brass Coupler

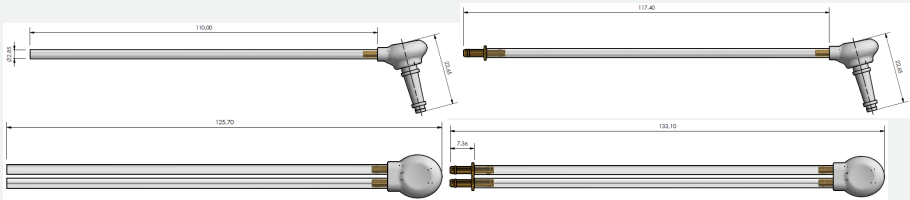

Probe Dimensions: Probe

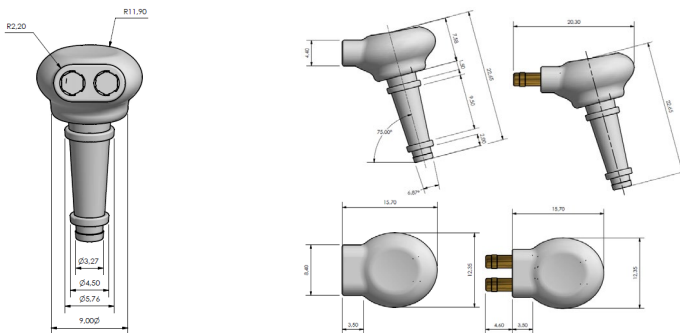

Probe Dimensions: Brass Coupler



Maintenance: Probes, Eartips and Associated Tubing

The probe can be cleared of any debris using only the cleaning kit provided by eMoyo. Special care should be taken not to push any debris further into the tubes. Eartips are SINGLE-USE ONLY.

KUDUwave™ Integrations

Noah Integration

If the end user intends to use the KUDUwave device with Noah, the user needs to have a valid Noah license. Ensure that you have the latest version of KUDUwave 5 (version 5.2 or above) and Noah (version 4.8 or above) to avoid incompatible versions. You can download the latest KUDUwave software from www.kuduwave.com and Noah from www.himmsa.com.

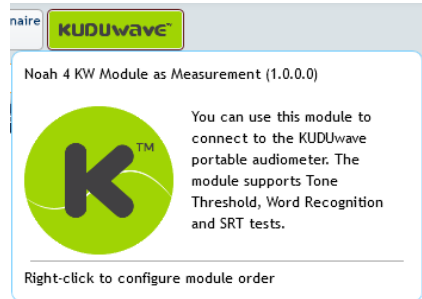

First Time Noah Users

Once you have downloaded and installed Noah, you will need to do an initial configuration of your settings. Click Next to move forward.

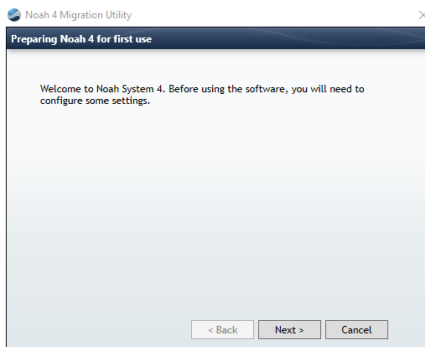

First choose where your patient data will be stored, either locally or on the Noah server.

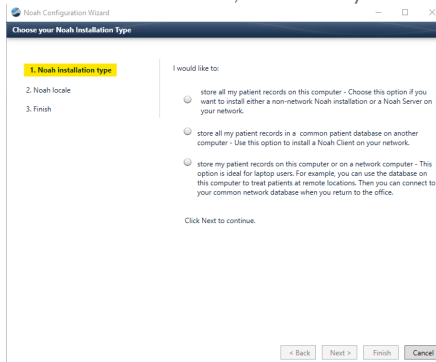

I would like to:

- store all my patient records on this computer** - Choose this option if you want to install either a non-network Noah installation or a Noah Server on your network.
IMPORTANT:
You will **need to reboot your system** in order to implement this setting.
- store my patient records on this computer or on a network computer** - This option is ideal for laptop users. For example, you can use the database on this computer to treat patients at remote locations. Then you can connect to your common network database when you return to the office.

Noah Server location:

Select the language you would like the program to operate in.

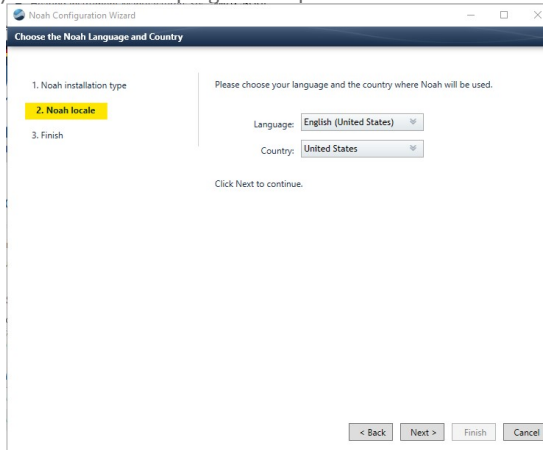

Finally, click Finish to save the setup. Noah will automatically open. Click OK to begin registering your

license.

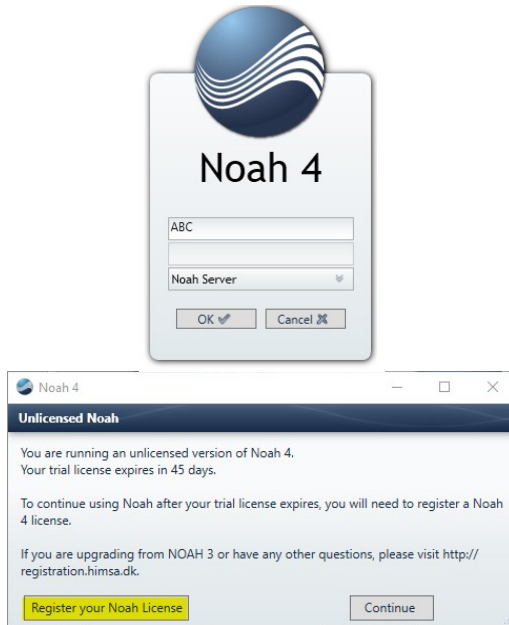

A web page will open where you can submit online the license number.

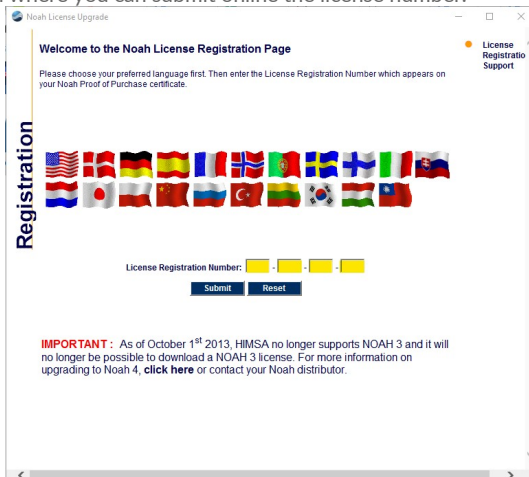

Make sure all your details are correct and click register to close and continue.

Installing the KUDUwave Plugin

To integrate your Noah and KUDUwave applications, ensure you have installed the following in consecutive order:

1. KUDUwave 5 software
2. KUDUwave Noah Module

Please refer to our website to download each file, or contact support to assist you.



KUDUwave



KUDUwave...

Getting Started with the KUDUwave Noah Module

Once both files have been installed, you will have to desktop shortcuts.

Only the grey icon opens the portal which integrates with Noah. You will be able to access all patients which are created in Noah from this portal.

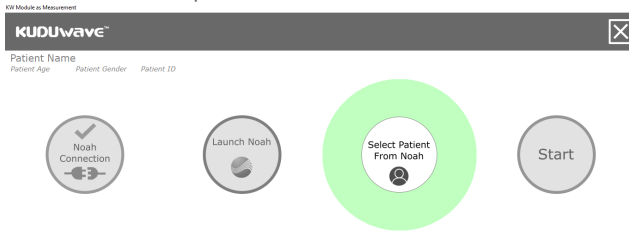

Once a patient is selected, begin the audiometry test with the KUDUwave by clicking “Start”.

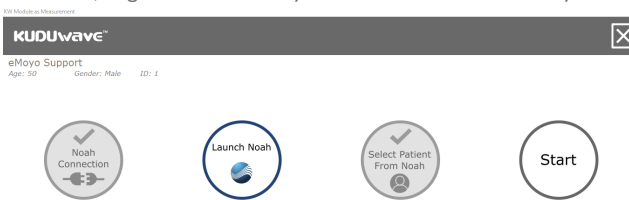

Alternatively, click “Launch Noah”, and click on the KUDUwave button at the top of the page.

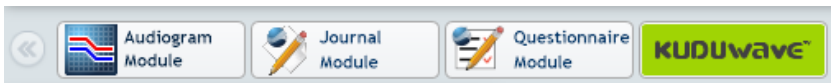

Click on the top half of the screen to begin the Pure Tone Threshold Audiometry test. See [how to conduct clinical tests](#) above for more information.

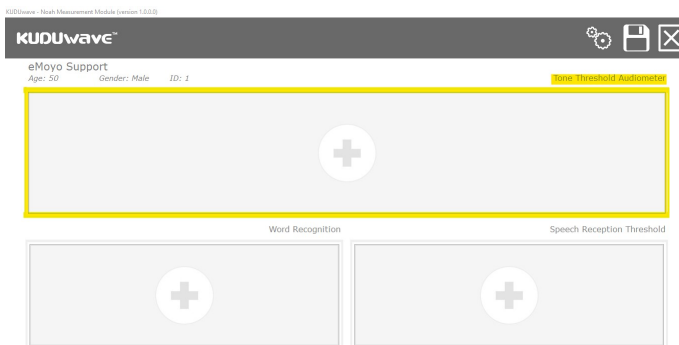

Once the test result has been saved, the audiogram will fill this space.

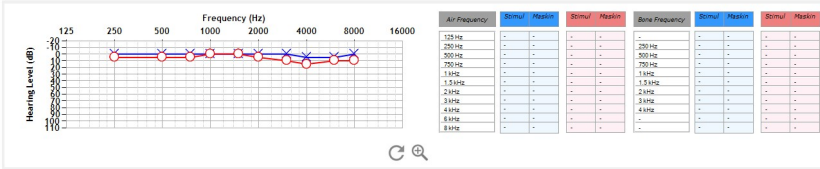

The bottom left hand corner, begins the Word Recognition KUDUwave test.

The KUDUwave test interface shows a large central area with a plus sign, labeled "Word Recognition" in yellow. Below it are two smaller areas, each with a plus sign. The right-hand area is labeled "Speech Reception Threshold".

The bottom right hand corner, begins the Speech Reception Threshold test.

The KUDUwave test interface shows a large central area with a plus sign, labeled "Word Recognition". Below it are two smaller areas, each with a plus sign. The right-hand area is labeled "Speech Reception Threshold" in yellow.

Settings



From the home, folders or patient screens you can access the settings menu by clicking the settings icon.

KUDUwave™ thinking out the booth **Settings** English Installation ID: B5449A1C

[Upload a letterhead](#)
[Design a letterhead](#)



Database

[Backup... \(Please do regular backups. Store the backup on an external drive like a memory stick\)](#)
[Import a backup and merge it with this database...](#)
[Change database \(You need administrative rights to perform this action\)](#)
[Flag all existing data in the database to synchronise up to the cloud](#)
[Re-index the database for fast searching](#)
[Move all patients in the root folder to a separate folder](#)
[Import eMoyo 4.0 data \(Any version before eMoyo 4.0 will automatically be imported\)](#)

Customization

When creating a new folder it must always be the the following default smart folder:

Default folder type

QR codes

[Print QR cards](#) Quantity

Do not automatically start QR code scanning when opening the home page

Password protect "Settings"

Password:

Upload a Letterhead

To include your personalised logo to patient reports, first create a 700x110 pixel image (click “[Design a letterhead](#)” to open Paint with a window automatically sized to these specifications) and save the image as a .bmp file. Click “[Upload a letterhead](#)”, “OK”, find your bmp file and “Save”.

Design a Letterhead

This option will open the Microsoft Paint program, automatically sized in the correct ratio for the KUDUwave software. Design your letterhead in this space and save it in the bitmap format. Later on upload the letterhead as explained above.

Backup

This function allows you to copy all patient data into one file, which will be saved to a chosen drive. Click on “[Backup...](#)”, select the destination to send the backup data to, and click “Save”.

Import and Merge Data from a Backup

To import a previously backed up version of all patient data, select “[Import a backup and merge it with this database...](#)”.

Note: A warning will pop up. Older versions of software may not support patient data which was backed up from a newer software version. Always run the latest version of software available.

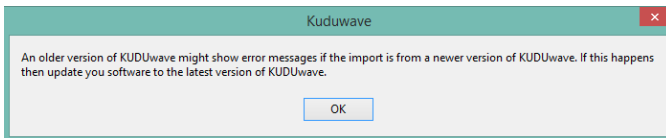

Click “OK”, and browse to the location of the backup file that you would like to import. Select the file and click “Open”. The data will be merged with the current database and be available on the home screen.

Change database (administration rights required)

This allows you to change the location of where all patient data is saved on your local hard drive. The following options are available once “Change database” is clicked on:

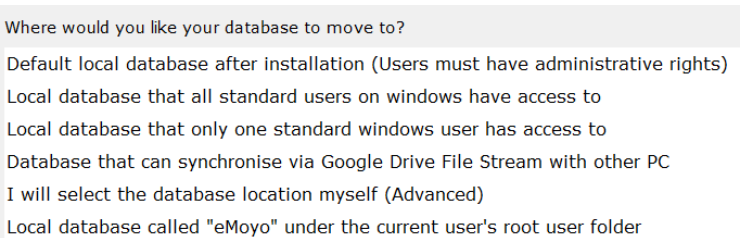

Select an option, then click the arrow key in the top left hand corner. Click the save icon to save the setting change.

Warning: Data is not automatically moved with the database location change. You will need to physically move the files from the original file location to the new location if you want to be able to view the patient data previously saved.

Flag all existing data in the database to synchronise up to the cloud

All data previously captured in earlier versions (before 5.2) of KUDUwave 5 software, will not be

flagged for syncing to the eMoyo server. Click this option to process all existing data for syncing. This is only necessary once, all tests done thereafter will be automatically flagged.

Re-index the database for fast searching

To enhance the speed of the search tool on your home screen, click this option and the database will be re-indexed.

Import eMoyo 4.0 Data

If you had eMoyo 4.0 you will need to import patient data into KUDUwave 5. By clicking “[Import eMoyo 4.0 data](#)”, a new interface will open. Click “Start Migration”. Once completed close this window and KUDUwave 5. Reopen the software and all patient data should be available. Contact support if data is found missing.

Set a default Smart Folder

All new folders created will have the settings associated with the smart folder type selected from the drop down menu.

Manage QR codes

Print multiple QR codes to later associate to patients, and set the webcam to automatically open with the software.

Password Security

Add a password to the settings page to restrict access here.

X-check (Cross Check)

The X-check verifies the calibration of the KUDUwave.

Note: This does not replace the need for calibrations as per local standards.



To cross check your KUDUwave click the **X-check** button in the system menu on the left hand side. If your KUDUwave is equipped with X-check the following start page will appear:



Hi, Are you ready to start your daily cross check?

1. Remove eartips from both sound tubes
2. Plug the left sound tube into the left X-check port
3. Plug the right sound tube into the right X-check port

Note: X-check is a verification tool and does not replace the need for calibrations as per your local standards



When you are ready click start



Follow the instructions and then click the Start button to run the X-check.

Note: that the X-check can only run if your KUDUwave is equipped with the cross check hardware. If this is not the case you will see the following screen:

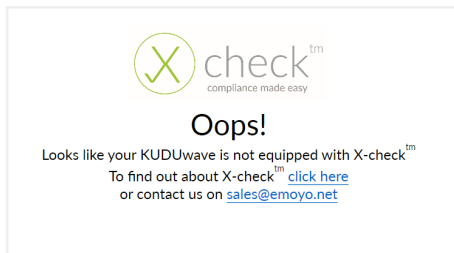

After clicking the “Start” button the X-check will run automatically and the following test page will be shown:

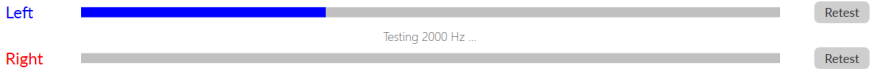

The X-check should take about 23 seconds to complete if the tests pass. A message will then be shown to tell you if your device calibration verification has passed:

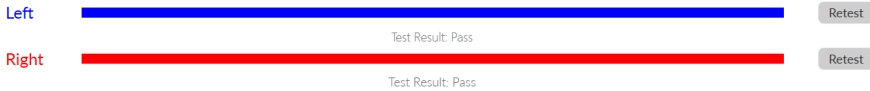

Congratulations, X-check has verified your calibration

[Detail view](#) [Finish](#)

Clicking the “Finish” button will exit the X-check application. Clicking the “Detail view” button will show the following Detail page:



Left	Amplitude Error [dB]	Test Frequency [Hz]	Amplitude Error [dB]	Right
Pass	0.19	125	0.16	Pass
Pass	0.38	250	0.46	Pass
Pass	-0.39	500	0.40	Pass
Pass	0.58	750	0.32	Pass
Pass	0.52	1000	-0.05	Pass
Pass	-0.06	1500	-0.31	Pass
Pass	0.58	2000	0.49	Pass
Pass	-0.04	3000	-0.24	Pass
Pass	0.25	4000	0.54	Pass
Pass	0.30	6000	0.23	Pass
Pass	-0.39	8000	-0.20	Pass
Pass	0.35	9000	0.13	Pass
Pass	-0.02	10000	0.44	Pass
Pass	-0.70	11200	-0.82	Pass
Pass	-0.10	12500	-0.45	Pass
Pass	-0.21	14000	0.12	Pass
Pass	0.14	16000	-0.58	Pass

This Detail page shows the test frequencies as well as the Amplitude Error.

The **Amplitude Error** is the discrepancy or difference between the calibrated level of the KUDUwaves

air conduction output and the actual air conduction output, which has just been measured by the X-check. Ideally all of these values should be zero.

Print Report

If you would like a PDF report, scroll down and click the **Print Report** button. This will generate and open a PDF, like the one shown here. The PDF report is automatically saved in the eMoyoDotNet/Pdf folder on your computer.

KUDUwave Cross Check Report



Test Details:

Cross Check Test Date:
 KUDUwave Calibration Date:
 KUDUwave Serial Number:

Left	Result	Amplitude Error [dB]	Test Frequency [Hz]	Amplitude Error [dB]	Right	Result
	Pass	0.18	112	0.14		Pass
	Pass	0.58	250	0.44		Pass
	Pass	-0.58	500	0.40		Pass
	Pass	0.58	750	0.51		Pass
	Pass	0.52	1000	-0.05		Pass
	Pass	-0.04	1500	-0.61		Pass
	Pass	0.58	2000	0.49		Pass
	Pass	-0.04	3000	-0.14		Pass
	Pass	0.25	4000	0.24		Pass
	Pass	0.50	6000	0.29		Pass
	Pass	-0.57	8000	-0.20		Pass
	Pass	0.55	9000	0.19		Pass
	Pass	-0.01	10000	0.44		Pass
	Pass	-0.70	11200	-0.81		Pass
	Pass	-0.16	12800	-0.48		Pass
	Pass	-0.11	14000	0.11		Pass
	Pass	0.14	16000	-0.20		Pass



X-check: Abnormal Test

If the test fails, a message will list common reasons which cause X-check to fail alternatively to your KUDUwave being out of calibration.

At least one test has failed. Please go through the checklist and click 'Retest':

1. Ensure that the sound tubes are plugged in tightly and deep enough
2. Ensure that the brass couplers are clean and you can see through them
3. Ensure that the sound tubes dont have damage nor are there any holes
4. Ensure that the KUDUwave is not moved or bumped while running the cross check

As an example, bumping or moving the KUDUwave while the X-check is running will prevent it from accurately measuring the air conduction output and cause the test to fail. Follow the instructions and click the “Retest” button for the failed side.

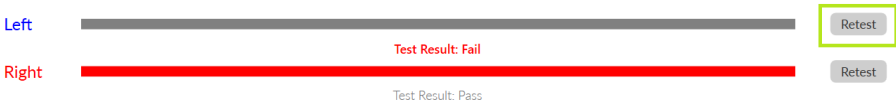

You can also click the “Detail view” button to go to the Detail page and get more information about why the test failed. Failed frequencies are shown in red along with a reason of why the test failed.

Result	Amplitude Error [dB]	Test Frequency [Hz]
Pass	0,63	125
Pass	0,82	250
Pass	0,05	500
Pass	0,94	750
Pass	0,93	1000
Pass	0,32	1500
Pass	0,94	2000
Pass	0,25	3000
Pass	0,50	4000
Pass	0,34	6000
Fail (Amplitude Deviation Too High +Frequency Deviation Too High +SNR Too Low+Recording Not Stable)	10,79	8000

If the test still fails after you have followed the instructions then your KUDUwave could be out of calibration. Contact eMoyo to book a calibration.

Troubleshooting

Computer is not able to connect to the KUDUwave

If the computer is not able to connect to the KUDUwave, the following message will pop up.

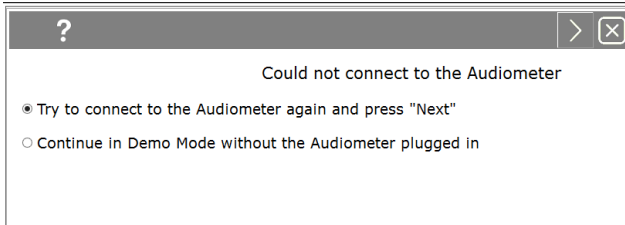

This means that the KUDUwave audiometer was not plugged in correctly.

Please follow these steps to correct the problem:

1. Cancel the current test by selecting  in the top right corner.
2. Unplug the KUDUwave from your computer, wait a few seconds, and plug it back in ensuring that both the KUDUwave and response button are firmly plugged in.
3. Restart the test.

The KUDUwave is incorrectly your current default audio record device

If a pop up error message says "AudioTympCtrl. The KUDUwave is incorrectly your current default audio record device. We will now try to fix the problem", click "OK" and the software will correct your PC settings.

Remote Assistance

We offer to help you remotely by taking control of your laptop with the TeamViewer plugin.

To download the TeamViewer remote assistance plugin, please visit:

<https://www.teamviewer.com/en/download/windows/>

For live remote assistance, make sure you have:

1. Downloaded and installed **TeamViewer** on your PC
2. An active **internet** connection.
3. Your **TeamViewer ID** and **Password** handy.

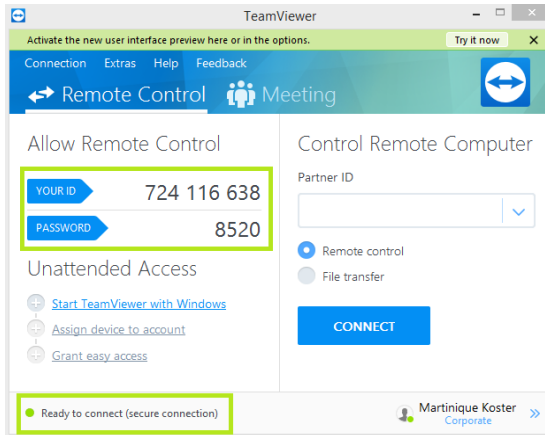

Get in contact with our Support Team at: support@emoyo.net

Cleaning and Maintenance

General Care

The KUDUwave is a highly sensitive, state of the art device that must be treated with care. It must be cleaned and disinfected regularly and care should be taken not to damage any of the sensitive microphones or speakers when cleaning or handling the device.

Cleaning Procedure

The KUDUwave must be thoroughly cleaned and disinfected after each and every use (i.e. before each new patient is tested) with a cleaning and disinfection wipes complying with EN1276 that are intended for use on plastic items.

When Cleaning the KUDUwave:

1. Disconnect all USB cables and use an antibacterial wipe to clean the KUDUwave headset, ear cups, sound tubes, response button and the bone vibrator (if it was used).
2. It is important to ensure that during cleaning no liquid enters any holes in the ear cups.
3. Used foam eartips must be disposed of after each test as medical waste.
4. When cleaning the device, avoid bending or twisting any of the cables or sound tubes.
5. If any permanent sharp bends, cracks or holes in the sound tubes are visible, replace them with spares provided. Calibration can be verified using the standard daily biological calibration check routine.
6. Check that the sound tube or brass ear-tip coupler has not become blocked or obstructed over time.

Warning: Never use acetone based cleaning products when cleaning the KUDUwave.

Note: Ear wax and debris can collect in the ear probe. Make sure that there is no debris on the ear probe or inside the disposable ear tip before placing an ear tip. Once debris or any foreign material has lodged into the little holes of the ear probe, it may be possible to remove the debris from the holes. If debris enters the holes, then the debris must be removed, cleaned and disinfected and the calibration should be verified using the standard biological calibration verification routines.

Warning: Make sure that there is no debris on the ear probe or inside the disposable ear tip before placing an ear tip onto the ear probe.

Note: The recommended daily biological calibration routine is as follows: Put the KUDUwave on your head and do an automatic KUDUwave tone threshold test of all the octave frequencies. Save the test results. Remove the KUDUwave, turn it around so that the left side is on the right ear and the right side is on the left ear and redo the automatic KUDUwave tone threshold test. Compare the left and right thresholds of the two tests with each other. None of the thresholds of the compared sides may differ with more than 10 dB.

Note: Disposable ear tips of different sizes act as barrier between the ear probe and the patient. Never reuse disposable ear tips because old ear wax and cleaning solutions can damage the ear probe permanently. Cleaning solutions also damages the foam of the eartips and can lead to incorrect readings. It is an irresponsible risk to clean eartips for re-use, as cleaning solution or wax can end up inside the ear probe and give incorrect results.

Warning: Never reuse disposable eartips. Eartips are cheap and any perceived cost saving will not outweigh the risks to the device and more importantly, the patient.

Calibration

In order for the KUDUwave to operate correctly it is vital that it is calibrated correctly. eMoyo has the equipment and necessary expertise to calibrate your KUDUwave. Please contact eMoyo to schedule your next calibration.

Daily Calibration Verification

It is advisable to perform a biological test at the start of each day that the KUDUwave will be used.

Annual Calibration

Annual calibration is required. eMoyo will calibrate and return your KUDUwave to you in accordance with your maintenance contract.

Note: The KUDUwave software has been designed to automatically warn you when the minimum calibration is due. Your device will be assessed annually to determine its serviceability before it is calibrated. The KUDUwave users can expect a minimum service life of 5 years.

Ad Hoc Calibrations

Some states or countries require audiometers to be calibrated more than once a year, especially when audiometers are used for mobile testing. Please make sure of what the legislative requirements are for your state or country. If you are ever in doubt whether the KUDUwave is in calibration it is recommended to verify the calibration biologically. If you are still in doubt it is essential to do an electro- acoustic calibration check.

Calibrations by Other Organisations

Due to the digital, robust and integrated design of the KUDUwave, chances of it going out of calibration are very slim. If another organisation wants to calibrate a KUDUwave, they may perform a typical calibration process to verify that the thresholds and frequencies of the unit are correct. After completing the calibration routine the calibration organisation will not need to adjust any thresholds

or frequencies. A calibration certificate must be issued to show that the KUDUwave is within calibration limits. In the unlikely event where the calibration shows limits outside acceptable limits, please contact eMoyo immediately.

Storage and Shipping

Warning: When shipping the KUDUwave please use the robust shock absorbing carry case to reduce the risk of damage to the device during transit.

Remember to seal the shipping container securely and to mark the container FRAGILE. Always store the KUDUwave out of direct sunlight in a clean and dry environment within the temperature and humidity limits detailed in the Technical Specifications.

Expected Service Life

The KUDUwave has an expected service life of at least five years of continuous use. Regular maintenance and general care will prolong the service life considerably. The KUDUwave can be used any number of times without restriction as long as it is both calibrated, and cleaned in accordance with the instructions in this User Manual.

Disposal and Recycling

It is advisable that the unit is returned to eMoyo for disposal and recycling. Please call +27 87 231 0132, or email support@emoyo.net, for instructions. Alternatively contact your international distributor or EU representative for disposal and recycling instructions.

Traveling with Your KUDUwave™

When traveling or shipping the KUDUwave it is important to use its original case. This casing is specifically designed for traveling and to absorb shock.

Please make sure to perform the following tasks:

- Always unplug all USB cables before placing the KUDUwave into the case.
- Also make sure the bone vibrator is attached to the headband to ensure it does not move while being shipped.
- Keep a foam eartip on each sound tube tip to prevent dirt from entering the sound tubes.
- Make sure no cables or sound tubes are caught up between the lid and the case before closing it.
- Always perform a biological test after traveling with your KUDUwave.

Upgrades, Maintenance and Support

Upgrades and New Features

eMoyo provides software and hardware upgrades for existing products. Please contact eMoyo at info@emoyo.net for the latest information on upgrades and new features. You can also visit our website at www.kuduwave.com.

Frequently Asked Questions (FAQs)

Please refer to websites for more information.

Support Service

At eMoyo we are confident that we can deliver a unique support service specifically designed for clients in remote areas. Contact us directly on our website by going to www.kuduwave.com and going to our support page for useful information. Or you can fill us in on your KUDUwave related problems by leaving a message on our contact us page.

Loan Devices

In the unlikely event that one of our devices has a problem, we will express courier a loan device to you at your cost (if available).

Online Virtual Support and Training

You can obtain online training using video conferencing software on your laptop.

To receive online virtual support, you will need to be located in an area with a good broadband internet connection.

Service, Support and Maintenance Contract

The latest service, support and maintenance contract can be obtained from your local sales representative.

Troubleshooting

If you experience problems, kindly send an email with as much information as possible (including the specific error message(s) and under which circumstances they occurred) to support@emoyo.net or contact your local sales representative. Additional support information can also be accessed at www.kuduwave.com.

Troubleshooting Checklist

Problem	Possible Solution
KUDUwave 5 software does not recognise that the KUDUwave is connected.	Check that the USB cables have been firmly connected from both ear cups to the USB ports on the personal computer. The left and right LED's will indicate if power is being received from the USB port.
	Try the second set of two new USB cables in case the original pair have become damaged.
	Ensure the Patient Response Handset has been connected to a USB port.
	Restart the computer and try to launch the software again.
Responses from the Patient Response button are not being recorded by the KUDUwave 5 software.	Ensure the Patient Response Handset has been firmly connected to the left ear cup.
	If another Patient Response Handset is available try it instead to ascertain if the response button is broken.
	Ensure that the patient environment is not too noisy so non-compliant results are not being recorded.
	Confirm that the operator can hear sounds being presented using the same headset.
The patient cannot hear sounds being presented even at high intensities.	Inspect the ear probes and eartips for debris that may be blocking the sounds.
I have run out of ear foam eartips.	Contact your sales representative to obtain new eartips. Do not continue using the existing ones or attempt to clean and reuse them.
The KUDUwave 5 software keeps telling me I have X days until the device needs calibration.	Ensure that you send your KUDUwave to eMoyo to be calibrated whenever prompted. Contact your local sales representative for more details.

In Need of Assistance?

Please contact your local IT consultant if you need assistance with confirming your personal

computer's specifications, or need an upgrade to meet the minimum requirements.

Technical Specifications

WARNING: No modification of this equipment is allowed.

Standards

The KUDUwave has been independently examined, tested and certified by a registered Notified Body in order to ensure Safety and Design Standards detailed in the General and Audiometry Specifications.

Audiometry Standards	Pure tone: BS EN 60645-1 (Type 3) Tympanometry BS EN 60645-5 (Type 1)
Other Standards	BS EN 60601-1, BS EN 60601-1-2, BS EN 60601-1-6, BS EN ISO 13485, BS EN ISO 14971, BS EN 62304, BS EN ISO 14155, BS EN ISO 15223-1, EN 1041
Medical CE mark	European Council Directive 93/42/EEC
Medical device class	Ila
Calibration	Laboratory calibrated in accordance with: BS EN 60645-1, EN 60645-2, SANS 10154-1 and SANS 10154-2

Instrument Specifications

Dimensions	210 x 260 x 110 mm	
Shipping dimensions	410 x 320 x 190 mm	
Net weight	697 g	
	813 g (including Tympanometer functionality)	
Shipping weight	1759 g	
	1930 g (including Tympanometer functionality)	
Power supply	2x standard laptop USB ports (5 V, 900 mA max per port) Unplug laptop from mains while testing	
Data transfer	Twisted KUDUwave™ dual USB cable 2x standard 3 meter A Male to Mini B Male USB cables	
Environmental conditions Indoor use only	Operational temperature	15 - 35 °C
	Operational humidity (non-condensing)	30 - 90 %
	Operational ambient pressure	98 - 104 kPa

	Shipping and storage temperature	10 - 40 °C
	Shipping and storage humidity (non-condensing)	30 - 75 %
	Shipping and storage ambient pressure	70 - 106 kPa
Warm-up time	10 - 20 sec	
Patient response system	Handheld tactile push button (USB)	
Sound tube	Medical grade PVC 80 shore, Clear with white x-ray line, L 180 mm, ID 1.7 mm, OD 2.9 mm	

Audiometry Specifications

Pure tone testing, speech testing, general, air conduction frequency specification, bone vibrator frequency specification, MPANLs and narrow band frequency specification.

Pure Tone Testing Specifications

Air conduction transducer	KUDUwave™ built-in insert earphone
Bone vibrator transducer	Radio Ear B71, B71W or B81
Bone vibrator placement	Forehead
Air conduction frequency range	125 Hz - 8 kHz standard 8 kHz - 16 kHz extended
Bone vibrator frequency range	250 Hz - 4 kHz
Frequency accuracy	< 0.05 %
Air conduction total harmonic distortion	< 3 %
Bone vibrator total harmonic distortion	< 6 %
Bone vibrator headband static force	5.4 N ±0.5 N
Air conduction calibration coupler	IEC 60318-4 (IEC 711) Ear Simulator RETSPL as per ISO 389-2, ISO 389-4*
Bone vibrator calibration coupler	IEC 60318-1 Ear Simulator with IEC 60318-6 Artificial Mastoid RETSPL as per ISO 389-3
Tone presentation	Pure tone or warble tone
Warble tone waveform	Sinusoidal
Warble tone repetition rate	4 - 20 Hz, Default = 5 Hz
Warble tone frequency deviation	5 - 25 %, Default = 10 %

Masking	Narrow band noise automatically centered at the test frequency
---------	--

*The default extended high frequency (9 kHz - 16 kHz) reference equivalent threshold sound pressure levels (RETSPL) are different to those of ISO 389-5 for insert earphones.

Speech Testing Specifications

Transducer	KUDUwave™ built-in insert earphone
Masking	Speech weighted random noise Spectrum constant from 125 Hz to 1000 Hz, then -12 dB/oct from 1 kHz to 6 kHz (tolerance-3 dB to +5 dB)
Calibration	All pre-recorded words in word lists calibrated against 1 kHz calibration signal

Additional Audiometry Specifications

Talk forward	~40 - 100 dBHL adjustable
Modes of operation	Manual Automatic shortened ascending (Hughson and Westlake method - ISO 8253-1) Automatic standard ascending Shortened and standard bracketing Fixed frequency Békésy sweep (optional) Pure tone Stenger (optional)
Air conduction system sound attenuation characteristics using Ambi-dome™ technology Combined ear-cup and ear-insert attenuation	31.0 dB at 125 Hz 37.7 dB at 250 Hz 43.8 dB at 500 Hz 40.8 dB at 1000 Hz 38.1 dB at 2000 Hz 52.3 dB at 4000 Hz 45.8 dB at 8000 Hz
Operational background sound pressure levels to test down to 0dBHL	< 70 dB SPL at 125 Hz < 69 dB SPL at 250 Hz < 58 dB SPL at 500 Hz < 53 dB SPL at 1000 Hz < 50 dB SPL at 2000 Hz < 59 dB SPL at 4000 Hz < 59 dB SPL at 8000 Hz

Air Conduction Frequency Specifications

Freq (Hz)	RET SPLs (dB)	Max Output (dBHL)
125	28.0	70
250	17.5	90
500	9.5	105
750	6.0	110
1000	5.5	110
1500	9.5	110
2000	11.5	110
3000	13.0	105
4000	15.0	100
6000	16.0	90
8000	15.5	80
9000	13.5	80
10000	12.5	80
11200	21.5	75
12500	25.5	75
14000	32.5	60
16000	41	50

Tested Bone Conduction Frequency Specifications

Freq (Hz)	RETFLs (dB)	Maximum Forehead Hearing Levels (dBHL)
250	79	35
500	72	50
750	61.5	60
1000	51	60
1500	47.5	70
2000	42.5	60

3000	42	60
4000	43.5	50

Maximum Permissible Ambient Noise Levels for the KUDUwave™

Hz	Average attenuation provided by industry standards headsets (dB)	Average attenuation provided by KUDUwave (dB)	Difference between the average attenuation provided by two earphones (dB)	Permissible ambient noise levels for screening audiometry (dB)	Maximum permissible ambient noise levels when a KUDUwave is used (dB)
125	3	31.0	28	52	80
250	5	37.7	32.7	38	70.7
500	7	43.8	36.8	22	58.8
1000	15	40.8	25.8	24	49.8
2000	26	38.1	12.1	31	43.1
4000	31	52.3	21.3	37	58.3
8000	24	45.8	21.8	35	56.8

Narrowband Masking Specifications

Freq (Hz)	Max Output (dBHL)	Tested Type 3 Max Output (dBHL)	Lower Cut-Off Frequency (Hz)	Upper Cut-Off Frequency (Hz)
125	60	60	110	148.75
250	60	60	215	292.5
500	75	75	430	577.5
750	90	80	650	885
1000	90	80	865	1160
1500	90	80	1287.5	1762.5
2000	90	80	1750	2287.5
3000	90	80	2612.5	3537.5
4000	90	80	3475	4730
6000	90	-	5291.7	7131.9
8000	80	-	6760	9360

Replacement Item Specification

Item	Specification	Comment/Warning
Eartip	Foam, manufactured to eMoyo specification	Do not replace with any other than eMoyo supplied items.
Ear Cup Cushions	Acoustic Foam, manufactured to eMoyo specification	Do not replace with any other than eMoyo supplied items.
Detachable Sound Tubes	Medical grade PVC	Do not replace with any other than eMoyo supplied items.

Tympanometry Specifications

Tympanometry General

Tympanometer transducer	KUDUwave™ built-in transducer
Influence of ambient pressure and temperature on calibration	The KUDUwave™ Pro TMP contains an environmental sensor which measures atmospheric pressure, temperature and relative humidity. Conversion between volume and admittance is handled automatically. The unit will ask for recalibration with the calibration cavities if the environment changes significantly.
Probe dimensions	Use only the tympanometry probes (identified on the packaging)
Maintenance information	The probe should be visually inspected at each use. If it is dirty it should be cleaned using the cleaning kit provided. If it shows signs of damage it should be replaced with a new probe.

Probe Signal

Frequencies	226Hz
Level	85 dB SPL (\approx 69 dB HL) \pm 3 dB in an IEC 60318-5 coupler Typical variation with loading: 6 dB at 0.5 cm ³ , 0 dB at 2 cm ³ , -6 dB at 5 cm ³
Frequency accuracy	\pm 1%
THD	<1%

Pneumatic system

Pressure range	+400 daPa to -600 daPa
Speed	50 daPa/s 200 daPa/s 400 daPa/s

Direction	Positive-to-negative and negative-to-positive
Maximum limits	-750 daPa and +550 daPa as measured in a 0.5 cm ³ cavity
Safety mechanism	Automatic valve release at safety maximum limits
Pressure accuracy	±10 daPa or ±10%, whichever is greater (in cavities from 0.5 cm ³ to 5 cm ³)
Speed accuracy	50 daPa/s: ±10 daPa/s 200 and 400 daPa/s: ±40 daPa/s (in cavities from 0.5 cm ³ to 5 cm ³)
Control	Automatic or manual
Indicator	Graphical display on PC

Admittance Measurement

Units	cm ³ or acoustic mmho (1 acoustic mmho = 10 ⁻⁸ m ³ /(Pa·s))
Range	0.2 cm ³ to 5 cm ³ (measurement plane)
Accuracy	±5% or ±0.1 cm ³ of the equivalent volume or ±0.1 acoustic mmho, whichever is greater. This is applicable for both static and dynamic modes of operation
Dependence on barometric pressure	The KUDUwave™ Pro TMP contains an environmental sensor which automatically compensates for the conversion between volume and admittance
Analysis performed	Compliance peak level; compliance peak pressure level; ear canal volume; peak width; tympanogram type

Reflex Measurements

Reflex test types	Ipsilateral, contralateral and bilateral (simultaneous ipsi- and contralateral)		
Reflex stimuli	500 Hz, 1000 Hz, 2000 Hz, 4000 Hz and broadband noise Frequency: ±1 % THD: < 5 % Broadband noise: ±5 dB from 500 Hz to 4000 Hz		
Stimulus level control	Step: 5 dB Accuracy: ±5 dB		
	Stimulus	Minimum [dBHL]	Maximum [dBHL]
	500 Hz	50	100
	1000 Hz	50	100
	2000 Hz	50	100

	<table border="1"> <tr> <td>4000 Hz</td> <td>50</td> <td>90</td> </tr> <tr> <td>Broadband noise</td> <td>50</td> <td>90</td> </tr> </table>	4000 Hz	50	90	Broadband noise	50	90											
4000 Hz	50	90																
Broadband noise	50	90																
Stimulus presentation control	on-off ratio: >70 dB rise and fall times: 20 ms residual A-weighted SPL with stimulus off: <25 dB SPL																	
Stimulus level variation with ear canal volume	<p>Since both ipsilateral and contralateral stimulus use probes the stimulus sound pressure level in the ear canal may vary depending on the ear canal volume. Possible variations are tabulated below relative to a 2 cm³ cavity (in which the stimulus is calibrated):</p> <table border="1"> <thead> <tr> <th rowspan="2">Stimulus frequency [Hz]</th> <th colspan="2">Ear canal SPL for different ear canal volumes relative to 2 cm³ [dB]</th> </tr> <tr> <th>0.5 cm³</th> <th>1.0 cm³</th> </tr> </thead> <tbody> <tr> <td>500</td> <td>14</td> <td>8</td> </tr> <tr> <td>1000</td> <td>11</td> <td>6</td> </tr> <tr> <td>2000</td> <td>12</td> <td>7</td> </tr> <tr> <td>4000</td> <td>12</td> <td>7</td> </tr> </tbody> </table>	Stimulus frequency [Hz]	Ear canal SPL for different ear canal volumes relative to 2 cm ³ [dB]		0.5 cm ³	1.0 cm ³	500	14	8	1000	11	6	2000	12	7	4000	12	7
Stimulus frequency [Hz]	Ear canal SPL for different ear canal volumes relative to 2 cm ³ [dB]																	
	0.5 cm ³	1.0 cm ³																
500	14	8																
1000	11	6																
2000	12	7																
4000	12	7																
Reflex sensitivity	0.01 cm ³ is the smallest displayed volume change																	
Reflex stimulus artefact level	<p>At stimulus levels greater than these levels there is a possibility of artefactual change which exceeds 0.03 cm³ occurring in the measurement display synchronously with the reflex stimulus in an ipsilateral measurement. Measured in cavities from 0.5 to 5 cm³.</p> <table border="1"> <thead> <tr> <th>Test Signal</th> <th>Ipsilateral reflex stimulus [dBHL]</th> </tr> </thead> <tbody> <tr> <td>500 Hz</td> <td>95</td> </tr> <tr> <td>1000 Hz</td> <td>95</td> </tr> <tr> <td>2000 Hz</td> <td>>100</td> </tr> <tr> <td>4000 Hz</td> <td>85</td> </tr> <tr> <td>Broadband noise</td> <td>>90</td> </tr> </tbody> </table>	Test Signal	Ipsilateral reflex stimulus [dBHL]	500 Hz	95	1000 Hz	95	2000 Hz	>100	4000 Hz	85	Broadband noise	>90					
Test Signal	Ipsilateral reflex stimulus [dBHL]																	
500 Hz	95																	
1000 Hz	95																	
2000 Hz	>100																	
4000 Hz	85																	
Broadband noise	>90																	

Temporal reflex characteristics	Initial latency: 20 ms \pm 15 ms Rise and fall time: 30 ms \pm 15 ms Terminal latency: 10 ms \pm 15 ms Undershoot and overshoot: <10 %
Pulsed stimulus characteristics	Rise and Fall time: 5 ms On time: 55 ms Off time: 60 ms Accuracy: 0 ms

Electromagnetic Compatibility (EMC)

Medical electrical equipment needs special precautions regarding EMC and needs to be installed and put into service according to the EMC information provided in this section. Portable and mobile radio frequency (RF) communications equipment can affect medical electrical equipment. Following the guidelines in this section will help prevent this.

Warning: The KUDUwave has been tested to the BS EN 60601-1-2:2015 for both immunity (susceptibility to interference from external sources) and emissions (interference generated by the KUDUwave). In order to ensure correct operation the following precautions must be adhered to:

The use of components and cables other than those specified or sold by eMoyo may result in increased emission or decreased immunity of the KUDUwave. The list of cables and components below must be adhered to in order to ensure compliance.

The KUDUwave should not be used adjacent to or stacked with other equipment. If adjacent or stacked use is necessary then the KUDUwave™ should be observed to verify normal operation in the configuration in which it will be used.

List of cables and components that affect compliance

- USB Cable, Type A to mini-B, maximum length 3.0 metres.

Guidance and Manufacturer’s Declaration - Electromagnetic Emissions

The KUDUwave™ is intended for use in the electromagnetic environment specified below. The customer or operator of the KUDUwave™ must ensure that it is used in such an environment.

Emissions test	Compliance	Electromagnetic environment - guidance
RF emissions CISPR 11	Group 1	The KUDUwave™ uses RF energy only for its internal function. Therefore, its RF emissions are very low and are not likely to cause any interference in nearby electronic equipment.
RF emissions CISPR 11	Class A	The KUDUwave™ is suitable for use in all

Harmonic emissions IEC 61000-3-2	Not applicable	establishments other than domestic and those directly connected to the public low-voltage power supply network which supplies buildings used for domestic purposes
Voltage fluctuations / flicker emissions IEC 61000-3-3	Not applicable	

Guidance and Manufacturer's Declaration - Electromagnetic Immunity

The KUDUwave is intended for use in the electromagnetic environment specified below. The customer or operator of the KUDUwave™ must ensure that it is used in such an environment.

Immunity test	IEC 60601 test level	Compliance level	Electromagnetic environment - guidance
Electrostatic discharge (ESD) IEC 61000-4-2	± 8 kV contact ± 2 kV, ± 4 kV, ± 8 kV, ± 15 kV air	± 8 kV contact ± 2 kV, ± 4 kV, ± 8 kV, ± 15 kV air	Floors should be wood, concrete or ceramic tile. If floors are covered with synthetic material, the relative humidity should be at least 30 %.
Electrical fast transient/burst IEC 61000-4-4	±2 kV for power supply lines ±1 kV for input/output lines 100 kHz repetition frequency (SIP/SOP port)	Power supply lines: not applicable, see note 2 ±1 kV for input/output lines 100 kHz repetition frequency (SIP/SOP port)	See note 2
Surge IEC 61000-4-5	±1 kV differential mode ±2 kV common mode	Not applicable, see note 2	See note 2
Voltage dips, short interruptions and voltage variations on power supply input lines IEC 61000-4-11	<5 % UT (>95 % dip in UT) for 0.5 cycle 40 % UT (60 % dip in UT) for 5 cycles 70 % UT (30 % dip in UT) for 25 cycles <5 % UT (>95 % dip in UT) for 5 sec	Not applicable, see note 2	See note 2
Power frequency (50/60 Hz) magnetic field IEC 61000-4-8	3 A/m 50 Hz or 60 Hz	3 A/m 50 Hz or 60 Hz	Power frequency magnetic fields should be at levels characteristic of a typical location in a typical commercial or hospital environment.

NOTE 1 - UT is the a.c. mains voltage prior to application of the test level.

NOTE 2 - Power supply line electrical fast transient is not applicable because the KUDUwave is powered from the USB port of a laptop running on its battery.

Guidance and Manufacturer's Declaration - Electromagnetic Immunity

The KUDUwave™ is intended for use in the electromagnetic environment specified below. The customer or operator of the KUDUwave™ must ensure that it is used in such an environment.

Immunity test	IEC 60601 test level	Compliance level	Electromagnetic environment - guidance
Conducted RF IEC 61000-4-6	3 V	3 V	<p>Portable and mobile RF communications equipment should be no closer to any part of the KUDUwave™, including cables, than the recommended separation distance calculated from the equation applicable to the frequency of the transmitter.</p> <p>Recommended separation distance:</p> $d = 1.2\sqrt{P}$ <p>$d = 1.2\sqrt{P}$ 80 MHz to 800 MHz</p> <p>$d = 23\sqrt{P}$ 800 MHz to 2.5 MHz</p>
	0.15 MHz - 80 MHz	0.15 MHz - 80 MHz	
Radiated RF IEC 61000-4-3	6 V in ISM bands between 0.15 MHz and 80 MHz	6 V in ISM bands between 0.15 MHz and 80 MHz	<p>where P is the maximum output power rating of the transmitter in watts (W) according to the transmitter manufacturer and d is the recommended separation distance in metres (m). Field strengths from fixed RF transmitters, as determined by an electromagnetic site survey a, should be less than the compliance level in each frequency range b. Interference may occur in the vicinity of equipment marked with the following symbol:</p> 
	80% AM at 1 kHz	80% AM at 1 kHz	
	3 V/m	10 V/m	
	80 MHz - 2.7 GHz	80 MHz - 2.7 GHz	
	80% AM at 1 kHz	80% AM at 1 kHz	

NOTE 1 - At 80 MHz and 800 MHz, the higher frequency range applies.

NOTE 2 - These guidelines may not apply in all situations. Electromagnetic propagation is affected by absorption and reflection from structures, objects and people.

- a. Field strengths from fixed transmitters, such as base stations for radio (cellular/ cordless) telephones and land

mobile radios, amateur radio, AM and FM broadcast and TV broadcast cannot be predicted theoretically with accuracy. To assess the electromagnetic environment due to fixed RF transmitters, an electromagnetic site survey should be considered. If the measured field strength in the location in which the KUDUwave™ is used exceeds the applicable RF compliance level above, the KUDUwave™ should be observed to verify normal operation. If abnormal performance is observed, additional measures may be necessary, such as re-orienting or relocating the KUDUwave™.

- b. Over the frequency range 150 kHz to 80 MHz, field strengths should be less than 3 V/m.

Recommended separation distance between portable and mobile RF communications equipment and the KUDUwave

The KUDUwave is intended for use in an electromagnetic environment in which radiated RF disturbances are controlled. The customer or the operator of the KUDUwave can help prevent electromagnetic interference by maintaining a minimum distance between portable and mobile RF communications equipment (transmitters) and the KUDUwave as recommended below, according to the maximum output power of the communications equipment.

Rated maximum output power of transmitter (W)	Separation distance according to frequency of transmitter (m)		
	150 kHz to 80 MHz $d = 1.2\sqrt{P}$	80 MHz to 800 MHz $d = 1.2\sqrt{P}$	800 MHz to 2.5 GHz $d = 2.3\sqrt{P}$
0.01	0.12	0.12	0.23
0.1	0.38	0.38	0.73
1	1.2	1.2	2.3
10	3.8	3.8	7.3
100	12	12	23

For transmitters rated at a maximum output power not listed above, the recommended separation distance *d* in metres (m) can be estimated using the equation applicable to the frequency of the transmitter, where *P* is the maximum output power rating of the transmitter in watts (W) according to the transmitter manufacturer.

NOTE 1 - At 80 MHz and 800 MHz, the separation distance for the higher frequency applies.

NOTE 2 - These guidelines may not apply in all situations. Electromagnetic propagation is affected by absorption and reflection from structures, objects and people.

End User License Agreement (EULA)

The eMoyoDotNet (Pty) Ltd. End-User License Agreement (EULA) is a legal agreement between you, either an individual or a single entity and eMoyo, for the KUDUwave device and software. Software includes the personal computer software and the KUDUwave device firmware.

Software may be installed and used by any number of people (either an individual or a single entity). The software may be installed on any number of computers. The software can be operated over a network by any number of people from any number of computers. When it is plugged in, the KUDUwave will check that the Personal Computer Software is suitable to control it. Additional software functionality purchased will be associated with a single device and such software will only work for devices that have the license to use the new software.

The hardware may be used by any number of people (either an individual or a single entity). The hardware may be used on any number of Personal Computers and can be operated over a network by any number of people.

eMoyo took all reasonable care to ensure a safe and compliant device, but there is always the slightest possibility for error. eMoyo and its employees and consultants do not take responsibility for any complications that may be the result of errors in the device or software.

Specifications are subject to change without notice due to the continued development and enhancement of the KUDUwave.

eMoyo reserves all rights not expressly granted.

Warranty and Disclaimer

Limited Warranty

eMoyoDotNet (Pty) Ltd. t/a eMoyo warrants that the KUDUwave, if properly used and installed as per eMoyo's instructions, will be free from defects in material and workmanship. The KUDUwave will conform to eMoyo's high quality specifications for a period of three years, as stipulated on the Terms and Conditions found on the invoice.

This warranty

- begins on the date of purchase, (for your convenience, please keep the dated tax invoice as evidence of this date)
- is extended through distributors,
- covers defect(s)
- and does not cover tamper, drop, misuse or modifications.

If the KUDUwave, which is the subject of this Limited Warranty, fails during the warranty period for reasons covered by this Limited Warranty, eMoyo will retain the option to repair or replace the KUDUwave. All shipping costs required to repair or replace the device remain the responsibility of the purchaser.

Disclaimer

The Purchaser shall have no claim against eMoyo whatsoever, notwithstanding the termination or lapse of any contract. eMoyo will not be held responsible for loss or damage of any nature whatsoever, whether direct or indirect, consequential or otherwise, sustained as a result of any goods or equipment supplied or any advice given or any installation affected or any maintenance undertaken by eMoyo being in any way defective or absent or not conforming to the description thereof as a result of any other cause whatsoever.

Under no circumstances will eMoyo be liable for damages arising from misuse or abuse of the goods. The Customer does hereby indemnify and hold eMoyo harmless against any claim by any third person arising directly or indirectly out of any defect(s) in the goods or equipment supplied and or advice given to the Customer.

KUDUwave™

eMoyoDotNetza (Pty) Ltd | Reg. No.: 2015/414566/07 | Director: Dr Dirk (H L) Koekemoer

1st Floor Silhouette House, 179 Beyers Naudé Drive, Northcliff, 2195, South Africa | P.O. Box 4944, Cresta, 2118, South Africa

Tel: +27 11 782-1154 | Fax: +27 11 86 542-0142 | www.emoyo.net | www.kuduwave.com

