

# Heat Mat





## Underfloor Heating

Call 01444 247020  
to find out more or  
visit our website at  
[www.heatmat.co.uk](http://www.heatmat.co.uk)

### HC90 WiFi Features

- Easy to use, quick to navigate
- Remote access and control via simple to use App
- Connects directly to wireless network, no gateway required
- Simple to set-up
- Features useful functions including holiday mode, temporary override mode and hold mode
- See energy use over a week, a month or a year
- Switch the thermostat to manual for the simplest control
- Floor and room temperature sensors
- Controls up to 16 Amp of underfloor heating directly without the need for a contactor
- Lot20 compliant
- Covered by a 1-Year Warranty

### Compatible with

-  Heating mats
-  Undertile heating cables
-  FlexHeat cables
-  6mm heating cables
-  CombyMat system



HC90  
Thermostats

## HC90 WiFi Thermostat

### Remote operation via your smart phone

Heat Mat's HC90 WiFi thermostat offers remote operation from anywhere in the world via its companion App while the touchscreen also allows easy in-home control. This electric underfloor heating thermostat can be used to control any of Heat Mat's underfloor heating systems.

The HC90 provides fully-automated and flexible underfloor heating control to suit the owner's daily schedule. It provides fully automated and flexible underfloor heating control to suit the owner's daily schedule.

The thermostat is supplied with various lifestyle modes including holiday, comfort, frost protection and boost for an hour of full-power warmth.

The wireless App control enables all aspects of the operation of the thermostat to be carried out via the simple to use App. You can choose to individually control a single thermostat, or combine multiple

thermostats to create heating zones.

In addition to its standard mode of operation the controller offers a number of other program modes to enhance its usability.

The holiday mode enables the controller to turn off your underfloor heating while you are away from the property and to automatically turn it back on ready for your arrival home.

The controller also provides a temporary override of the target temperature for when you would like to boost or lower the temperature in the relevant room. The alternative hold mode allows you to set a desired temperature and time period and the controller will hold the temperature at the desired level for the indicated time before reverting back to the standard heating schedule.

Within the App as well as having full control over the thermostat you can also review all functions as well as the energy use of your heating system.



### HC90-WHT-WiFi

Simple App control without the need for a gateway.

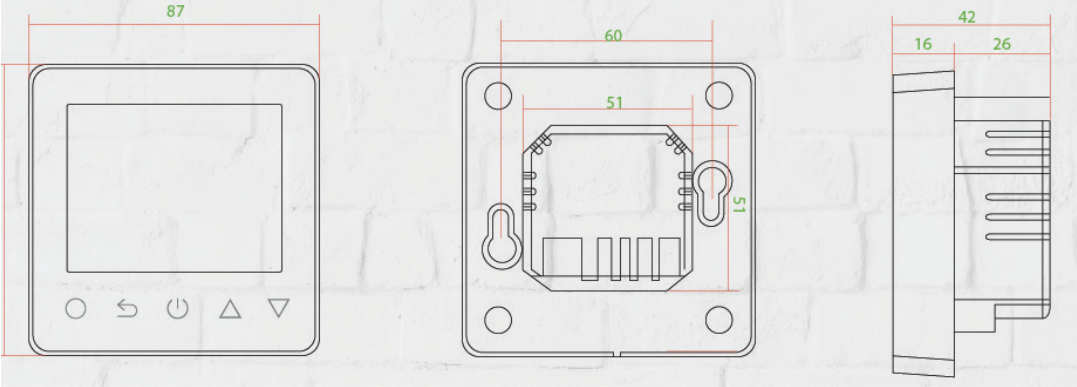

### Simple Connection

The controller is designed to be straightforward to connect to your wireless network via the App and it does not require a separate hub.

If a wireless connection is not available for any reason you can still access all functions of the thermostat through the conventional touch screen.

### App control

Through App control you can monitor and adjust your heating system from anywhere in the world and you can also review the energy usage of your system at any time.

### Sensor settings

The thermostat has three sensor options. In most circumstances the thermostat will operate on the room temperature with floor temperature limitation, which prevents the floor from overheating.

For times when the thermostat is outside of the room being heated it is operated on floor temperature only, and for controlling other forms of heating the thermostat can be used on room temperature only.



Control the system via an App - scan to download

### Lifestyle Modes

The thermostat offers a number of 'modes' for easy temperature control. These modes override the programmed heating schedule and provide the homeowner with a quick way to adjust the thermostat, whilst retaining their day-to-day heating settings.

**Hold mode** - This will override the current heating program and allow manual adjustment of the target temperature for up to 24 hours. This might be used if the owner wanted to heat a room, that might normally be unheated, for a short time.

**Temporary override mode** - the underfloor heating temperature you set will stay as the new target temperature overriding the heating schedule. At the end of that time period, the thermostat returns to the 'default schedule' or programmed operation. This could be used when returning to a cold room to warm the space as quickly as possible.

**Frost protection mode** - used when heating is not needed but the temperature must be kept above freezing. This is usually used in holiday cottages, outbuildings or properties that may be left unattended for long periods of time and is accessed through the advanced settings menu.

**Holiday mode** - this allows the heating to be set to a minimum while the homeowner is away on holiday, saving both energy and money. Holiday start and end dates must be set and the thermostat will ensure that the floor is kept above freezing and the home is warm when they return.

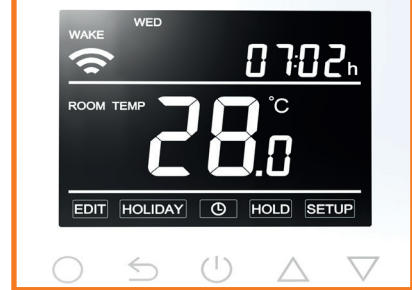

### HC90 WiFi Thermostat Technical Specification

Supply Voltage	85-265 V AC + 10% 50/60Hz
Output relay	2019 Max 15A 2020 onwards Max 16A
Interrupter	1-pole, 16A
Temperature range	+5 / +40°C
Floor limit range	+20 / +45°C
Heating schedule	4-event program
Wireless	Yes
Battery backup	1 year
Ambient temperature	0/+40°C during operation
On/Off differential	0.5°C
Housing	IP21
External sensor type	NTC (12 KΩ) 3m
Dimensions (H/W/D)	82/82/40mm (23mm depth)
Display	176x220 pixel TFT – Resistive touch
WiFi	2.4Ghz

### Wiring

Heating systems must always be controlled by a suitable electric underfloor heating thermostat with floor temperature limitation. Heat Mat thermostats are rated to 16 Amps, and if a system exceeds this loading a suitably rated contactor should be used. The circuit must be protected by a 30mA RCD and suitably rated fuse or circuit breaker.



### About Heat Mat

With more than 1,400,000m<sup>2</sup> of underfloor heating installed, 22 years' experience of the UK underfloor heating market and a wealth of knowledge on Scandinavian ice and snow melting systems, you can rely on Heat Mat to understand your needs and supply the products to satisfy your requirements.

This is why we are the Professional's Choice, the number one supplier of electric underfloor heating and ice and snow melting systems to the UK's professional installation market.



### Contact us

Heat Mat Limited  
Ashwyn Business Centre,  
Marchants Way, Burgess Hill,  
West Sussex, RH15 8QY

T. 01444 247020  
F. 01444 247121  
Email sales@heatmat.co.uk

[www.heatmat.co.uk](http://www.heatmat.co.uk)

Version: 1

# Heat Mat

## Underfloor Heating



To see all of our products use your smartphone to scan this code.